

ICE LED 1.0 - 1.1

Istruzioni per l'installazione - *Installation instructions*



Luce & Light
Pag. 1 - rev.01



IT



ATTENZIONE

Consigliamo di leggere con attenzione le seguenti istruzioni e di conservarle.

IMPORTANTE:

- Prima di procedere all'installazione o alla manutenzione disinserire sempre l'energia elettrica.
- L'apparecchio deve essere installato da personale qualificato.
- Modifiche o manomissioni del prodotto, non autorizzate dall'azienda, annullano ogni condizione di garanzia.
- L'azienda **L&L Luce&Light** declina ogni responsabilità qualora l'installazione non avvenga secondo le norme vigenti.
- Le informazioni contenute nel presente documento possono essere modificare in qualsiasi momento senza preavviso e non comportano l'assunzione, nemmeno implicita, di alcuna obbligazione da parte della **L&L Luce&Light**.

COLLEGAMENTI ELETTRICI:

- Le lampade a LED funzionano con corrente costante.
- Questo prodotto deve essere **collegato in serie** rispettando la polarità.
- Per la scelta degli alimentatori fare attenzione alla **corrente** alla quale vanno alimentati i LED e alla **potenza massima assorbita** dagli stessi.
- Il numero totale dei LED da alimentare va contato per singola lampada (es: 2 faretti a 3 LED da 1W = totale 6 LED da 1W= 6W).
- **L'impianto va alimentato solo dopo che tutti i faretti sono collegati.** Collegare i singoli faretti con alimentatore in tensione può comportare la rottura del faretto per sovratensione a vuoto.
- Lampade e alimentatori devono essere installati in scatole o luoghi con circolazione d'aria per permettere un naturale scambio di calore senza che vi sia un surriscaldamento dei dispositivi.
- L'alimentatore elettronico è stabilizzato in corrente, quindi entro certi limiti compensa automaticamente la caduta di tensione dovuta alla lunghezza dei cavi; consigliamo comunque di non superare i 30mt.
- Non connettere interruttori sul circuito secondario.

NOTE:

- **Per eseguire il collegamento dei cavi utilizzare muffole con resina o nastro autoagglomerante al fine di evitare infiltrazioni d'acqua.**

EN



WARNING!!!

Please read the following instructions carefully.

IMPORTANT:

- Although LED runs on a very low voltage, always cut off the power supply before installing the LED light or subjecting it to maintenance.
- Unauthorised alterations or tampering of the product will invalidate all the conditions of guarantee.
- This fixture must be installed by a qualified electrician.
- **L&L Luce&Light** is not responsible if its fixtures are not installed in according to local safety standards.
- Data contained in this document may be changed at any moment without prior notice and do not place **L&L Luce&Light** under any implicit or explicit obligation.

ELECTRICAL CONNECTIONS:

- LED lights run at constant current.
- LED lights must be **connected in series** respecting polarities.
- As for the choice of the power supplies, please consider the current through which they are fed and the max power consumption of LEDs you have to install.
- The total number of LEDs to be fed must be counted for each single spot (e.g. 2 spots with 3 LEDs 1W each= 6 LEDs 1W in all= 6W).
- **The system must be fed only if all the spots are connected.** The connection of the single spots with the power supply in voltage may get the spot broken due to over-tension in vain.
- The power supplies must be installed in aerated rooms, far from heat sources. A situation of overworking or a lack of air circulation will not permit a natural dissipation.
- The electronic power supply is current-stable, therefore it partially compensates the voltage-drop problems related to the cable length; anyhow we suggest not to overcome 30 metres.
- Never use switches on secondary circuit.

NOTES:

- **Wire connections must be realized with self amalgamating scotch or similar.**



ICE LED 1.0

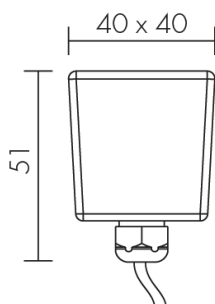

ICE LED 1.1

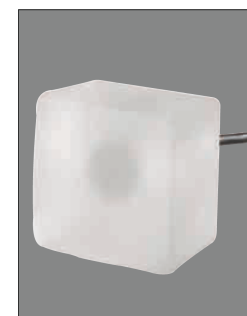
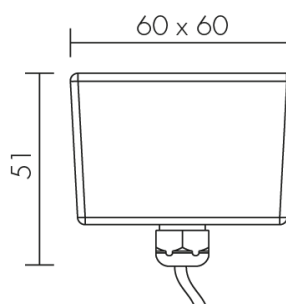

L&L Luce&Light srl
Via Della Tecnica, 42 - 36031 Povolario di Dueville (VI) - Italy
Tel. +39 0444 360571 - Fax +39 0444 594304

www.lucelight.it - lucelight@lucelight.it

INCASSI DA ESTERNO/INTERNO
OUTDOOR/INDOOR RECESSED SPOTLIGHTS

20/02/2015 16.28



DE

ACHTUNG

Bitte lesen Sie sorgfältig die folgenden Anweisungen und bewahren Sie sie auf.

WICHTIG:

- Trennen Sie die Anlage immer vom Stromnetz bevor sie installiert oder gewartet wird.
- Die Anlage darf nur von Fachpersonal installiert werden.
- Bei unsachgemäßer oder der Gebrauchsanleitung zuwiderlaufender Benutzung erlischt die Garantie.
- L&L Luce&Light übernimmt keine Haftung bei nicht regelrechter Installation.
- Die in diesem Dokument enthaltenen Informationen können jederzeit und fristlos verändert werden und sind für **L&L Luce&Light** keine explizite oder implizite Verpflichtung.

ELEKTRISCHE VERBINDUNG:

- Die LED Lichter funktionieren mit konstantem Strom.
- Die LED Lichter müssen in **Reihenschaltung** mit Beachtung der Polarität montiert werden.
- Bei der Auswahl der Netzanschlußgeräte bitte beachten Sie den Strom, mit dem die LEDs versorgt werden, und die maximale Leistung der zu installierenden LEDs.
- Die Gesamtanzahl der zu versorgenden LED Lichter wird je einzelne Lampe gezählt (z.B. 2 Beleuchtungen mit je 3 LEDs mit 1W = insgesamt 6 LEDs mit 1W = 6W).
- Die Anlage darf nur dann versorgt werden, wenn alle Beleuchtungen angeschlossen sind. Der Anschluß der einzelnen Beleuchtungen mit dem Netzanschlußgerät unter Spannung kann die Beleuchtung durch Überspannung beschädigen.
- Lichter und Netzanschlußgeräte müssen in belüfteten Gehäusen oder Räumen installiert werden. Die erzeugte Wärme muss entweichen können, damit eine Überhitzung vermieden wird.
- Das elektrische Netzanschlußgerät steht unter Gleichstrom, d.h. in gewissem Maße kompensiert es automatisch den Spannungsabfall wegen langer Kabeln; wir empfehlen eine maximale Länge von 30m.
- Keine Schalter dürfen an den Sekundärkreis angeschlossen werden.

BEMERKUNG:

Für den Anschluß der Kabel sollten Fäustlinge mit Harz oder agglomeriertes Klebeband verwendet werden um Eindringen des Wassers zu vermeiden.

FR

ATTENTION!!!

Lisez attentivement les instructions suivantes et conservez-les.

IMPORTANT:

- Avant d'effectuer les opérations d'installation ou de maintien, déconnectez toujours l'appareil du réseau électrique.
- L'appareil doit être installé par du personnel qualifié.
- Toute modification ou altération du produit, non autorisée par le fabricant, annule toutes les conditions de garantie.
- La société L&L Luce&Light décline toute responsabilité dérivant d'une installation non conforme aux normes en vigueur.
- Les informations contenues dans le présent document peuvent être modifiées dans n'importe quel moment sans préavis et ne comportent pas la prise en charge, explicite ou implicite, d'aucune obligation de la part de la société **L&L Luce&Light**.

CONNEXIONS ELECTRIQUES :

- Les lampes à DEL marchent à courant constant.
- Ce produit doit être **connecté en série**, en respectant la polarité
- Lorsque vous choisissez des alimentateurs, faites attention au courant auquel il faut alimenter les DEL et à la puissance maximum absorbée par eux.
- Comptez le numéro total des DEL à alimenter pour chaque lampe (par exemple : 2 phares à 3 DEL de 1W = total 6 DEL de 1W= 6W).
- L'installation doit être alimentée seulement après avoir connecté tous les petits phares. Si on connecte les phares à un système d'alimentation en tension, le phare peut se casser à cause de la surtension à vide.
- Les lampes et les systèmes d'alimentation doivent être installés dans des boîtes ou des endroits où la circulation de l'air permet d'obtenir un échange de chaleur naturel, sans surchauffer les dispositifs.
- L'alimentateur électronique est stabilisé en courant, c'est pour cette raison que dans certaines limites il compense automatiquement la chute de tension provoquée par la longueur des câbles ; ne supérez pas les 30 mètres.
- Ne connectez pas les interrupteurs sur le circuit secondaire.

NOTES:

Afin de mettre en œuvre la connexion des câbles, utilisez des chambres de raccordement avec de la résine ou une bande auto-agglomérante pour éviter toute infiltration d'eau.



ICE LED 1.0

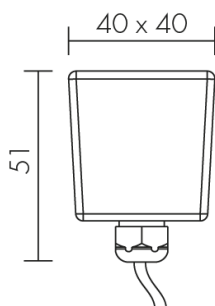

ICE LED 1.1

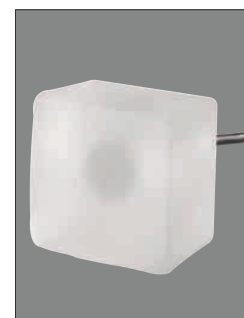
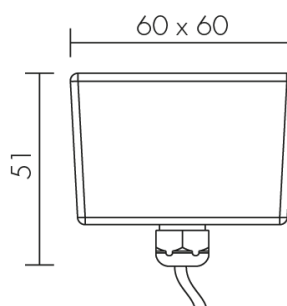

ICE LED 1.0 - 1.1

Istruzioni per l'installazione - *Installation instructions*



L&L

Luce & Light
Pag. 3 - rev.01

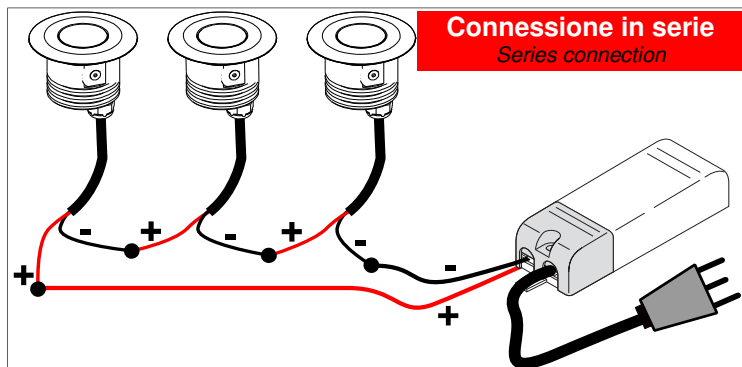

Connessione in serie
Series connection

ATTENZIONE!!!

IL COLLEGAMENTO DEI SINGOLI FARETTI LED VA FATTO SEMPRE IN SERIE.
L'IMPIANTO VA ALIMENTATO SOLO DOPO CHE TUTTI I FARETTI SONO COLLEGATI.

WARNING!!!

LED LIGHTS MUST BE CONNECTED IN SERIES RESPECTING POLARITIES.
THE SYSTEM MUST BE FEEDED ONLY ALL THE SPOTS HAVE BEING CONNECTED.

1

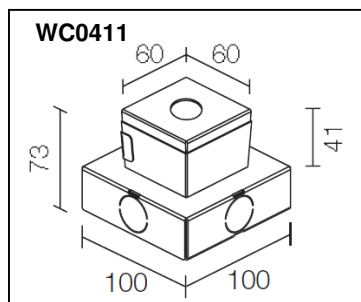
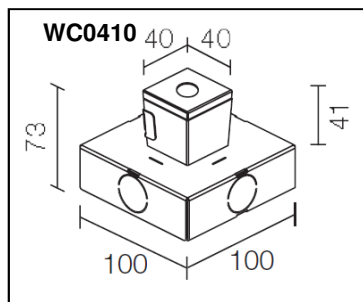

2

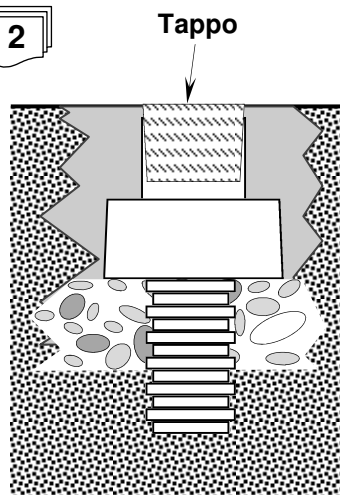

POTENZA ASSORBITA <i>POWER CONSUMPTION</i>	max 1W;
ALIMENTAZIONE <i>SUPPLY VOLTAGE</i>	220mA; 350mA;
ALIMENTATORE <i>POWER SUPPLY</i>	Non incluso.
COLLEGAMENTO <i>CONNECTION</i>	Collegare in serie. <i>Series connections</i>
N° E TIPO DI LED USATI <i>N° AND TYPE OF LED USED</i>	1 power LED;
COLORI LED DISPONIBILI <i>LED COLOURS AVAILABLE</i>	Bianco: 5000K; 4000K; 3000K; 2700K; blue;
INDICE RESA CROMATICA CRI <i>CRI</i>	75÷85
ANGOLO DI EMISSIONE (OTTICA) <i>ANGLE OF EMISSION (LIGHT BEAM)</i>	D (diffuso);
FLUSSO TOTALE APPARECCHIO <i>TOTAL LUMINOUS FLUX</i>	30 lm (3000K a 350mA)
TEMPERATURA DI ESERCIZIO <i>OPERATING TEMPERATURE</i>	0°C ÷ +45°C
FINITURA <i>FINISHING</i>	Vetro sabbato
FISSAGGIO <i>FIXING</i>	Incasso con cassaforma WC0410 (Ice LED 10) o WC0411 (Ice LED 11)
CLASSE ISOLAMENTO <i>APPLIANCE CLASS</i>	CLASSE III <i>CLASS III</i>
PESO <i>WEIGHT</i>	0.38kg
GRADO IP <i>IP RATE</i>	IP67

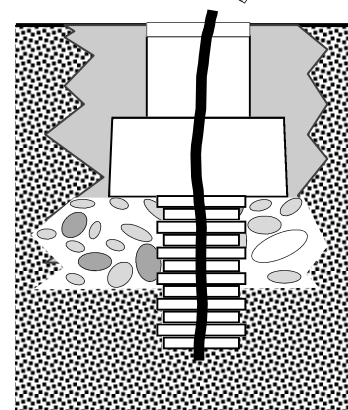
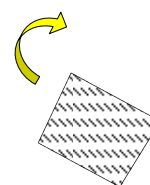

L&L Luce&Light srl
Via Della Tecnica, 42 - 36031 Povolara di Dueville (VI) - Italy
Tel. +39 0444 360571 - Fax +39 0444 594304

www.lucelight.it - lucelight@lucelight.it

INCASSI DA ESTERNO/INTERNO
OUTDOOR/INDOOR RECESSED SPOTLIGHTS

ICE LED 1.0 - 1.1

Istruzioni per l'installazione - *Installation instructions*



L&L

Luce & Light
Pag. 4 - rev.01



3

Waterproof connection
Connessione stagna

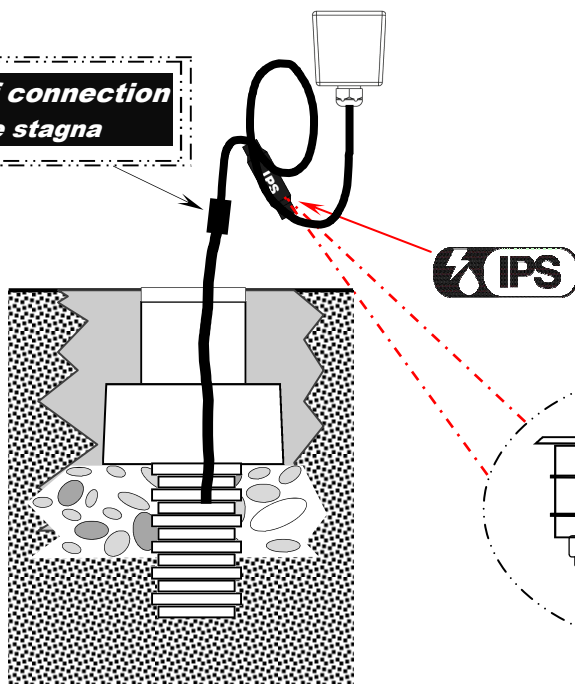

CONNETTERE RISPETTANDO LA POLARITÀ
LED LIGHTS MUST BE CONNECTED
RESPECTING POLARITIES

- +** ROSSO-MARRONE-BIANCO
RED-BROWN-WHITE
- NERO/BLU
BLACK-BLUE

NON TAGLIARE!!
Do not cut

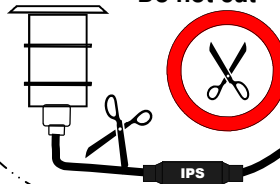

4

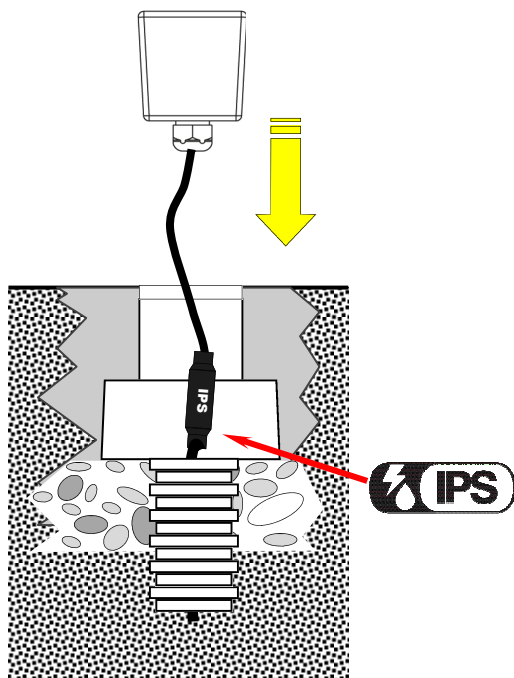

5

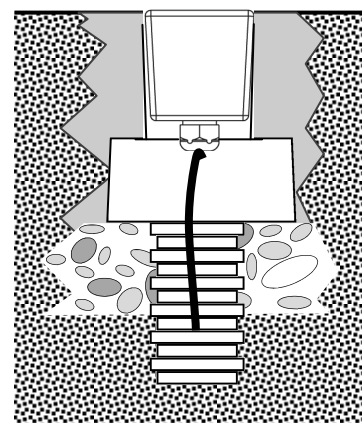

Non idoneo per installazioni
in piscine e fontane.
Not for permanent submersion
in swimming-pools or fountains



Nessuna parte metallica dell'apparecchio deve
stare a contatto diretto con il terreno, o venire a
contatto con sostanze chimiche
aggressive (ad esempio concimanti, calce,
detergenti aggressivi).

*Any metal part must not be in direct contact
with the ground or in contact with aggressive
chemical elements (ex. fertilisers, herbicides,
lime, aggressive cleaners).*



L&L Luce&Light srl
Via Della Tecnica, 42 - 36031 Povolaro di Dueville (VI) - Italy
Tel. +39 0444 360571 - Fax +39 0444 594304

www.lucelight.it - lucelight@lucelight.it

INCASSI DA ESTERNO/INTERNO
OUTDOOR/INDOOR RECESSED SPOTLIGHTS

20/02/2015 16.28