

LAMPADE DA LETTURA

DA INTERNO



^
WALL 3
3000K, 2,5W, cromato, 400 mm

602

L&L Luce&Light



WALL

LAMPADE DA LETTURA
PER CONTESTI RESIDENZIALI E HOSPITALITY



**MONTAGGIO
SU PARETE**



**MONTAGGIO
SU FRUTTO CIECO**



**MONTAGGIO
SU MENSOLA**

EMISSIONE REGOLABILE



3000K 5000K



regolabile



WALL 1 p. 604
2,5W 230Vac
3,5W 230Vac



WALL 3 p. 605
2,5W 230Vac
3,5W 230Vac

VERSIONE CON OTTICHE



2700K 3000K 4000K 5000K



stretta



media



larga



WALL 8.1 p. 607
2,5W 230Vac
3,5W 230Vac



WALL 8.0 p. 606
max 2W max 500mA



WALL 8.2 p. 607
2,5W 230Vac
3,5W 230Vac

WALL 1

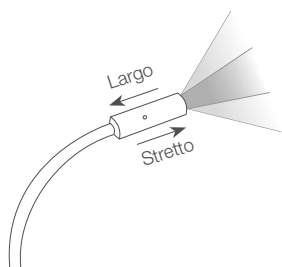

Emissione regolabile



Stelo flessibile:
 Ø6 mm - 400 mm
 Ø8 mm - 400/500 mm

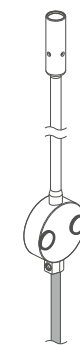

Versione standard:
 uscita cavo inferiore

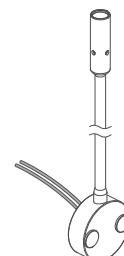

Versione su richiesta:
 uscita cavo posteriore



kg 0,30 400 mm Ø6 mm
 kg 0,32 400 mm Ø8 mm
 kg 0,33 500 mm Ø8 mm

IP20

A A+ A++

POTENZA / ALIMENTAZIONE CODICE

2,5W 230Vac 400 mm stelo Ø6 mm
L11640 **C** Cromato
L11640 **D** Dorato
L11640 **S** Satinato

3,5W 230Vac 400 mm stelo Ø6 mm
L12640 **C** Cromato
L12640 **D** Dorato
L12640 **S** Satinato

2,5W 230Vac 400 mm stelo Ø8 mm
L11840 **C** Cromato
L11840 **D** Dorato
L11840 **S** Satinato

3,5W 230Vac 400 mm stelo Ø8 mm
L12840 **C** Cromato
L12840 **D** Dorato
L12840 **S** Satinato

2,5W 230Vac 500 mm stelo Ø8 mm
L11850 **C** Cromato
L11850 **D** Dorato
L11850 **S** Satinato

3,5W 230Vac 500 mm stelo Ø8 mm
L12850 **C** Cromato
L12850 **D** Dorato
L12850 **S** Satinato

COLORE LED	5 - 3000K 0 - 5000K
OTTICHE	range ottico 20°±55°
FLUSSO SORGENTE	145 lm (3000K, 3,5W)
FLUSSO EMESSO	61 lm (3000K, 3,5W)
NUMERO E TIPO LED	1 power LED 1/4 ANSI BIN, 50000h L90 B10 (Ta 25°C)
MATERIALE	corpo in alluminio, stelo in ottone
ALIMENTATORE	integrato nella spina con interruttore sul cavo
CAVI DI ALIMENTAZIONE	incluso cavo di 1,5 m, con spina e alimentatore integrato
MONTAGGIO	su superficie (parete)
NOTE	su richiesta disponibile la versione con uscita cavo posteriore
DATI FOTOMETRICI	vedi pag. 836



WALL 3

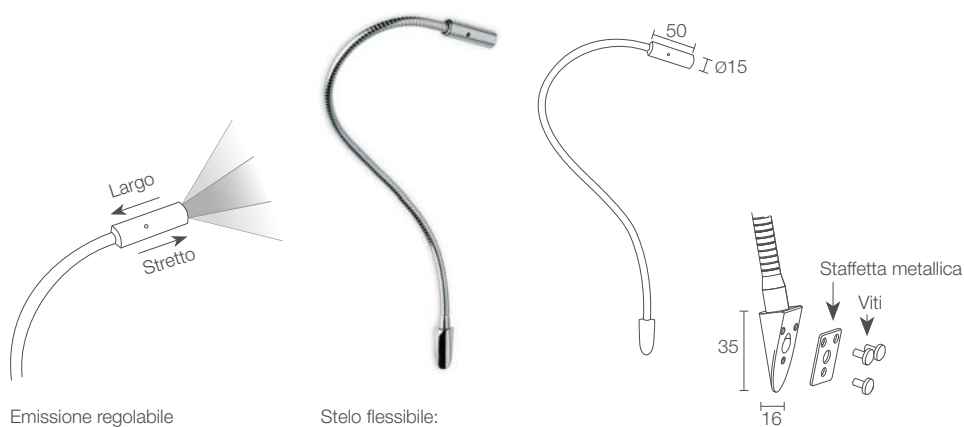

Emissione regolabile

Stelo flessibile:
Ø8 mm - 400/500 mm

CE (LED) □ kg 0,19 400 mm IP20
kg 0,29 500 mm

A A+ A++

**POTENZA / ALIMENTAZIONE
CODICE**

2,5W 230Vac 400 mm stelo Ø8 mm
PL11840 C Cromato
PL11840 D Dorato
PL11840 S Satinato

3,5W 230Vac 400 mm stelo Ø8 mm
PL12840 C Cromato
PL12840 D Dorato
PL12840 S Satinato

2,5W 230Vac 500 mm stelo Ø8 mm
PL11850 C Cromato
PL11850 D Dorato
PL11850 S Satinato

3,5W 230Vac 500 mm stelo Ø8 mm
PL12850 C Cromato
PL12850 D Dorato
PL12850 S Satinato

COLORE LED	5 - 3000K 0 - 5000K
OTTICHE	range ottico 20°-55°
FLUSSO SORGENTE	145 lm (3000K, 3,5W)
FLUSSO EMESSO	61 lm (3000K, 3,5W)
NUMERO E TIPO LED	1 power LED 1/4 ANSI BIN, 50000h L90 B10 (Ta 25°C)
MATERIALE	corpo in alluminio, stelo in ottone
ALIMENTATORE	incluso
CAVI DI ALIMENTAZIONE	incluso cavo bipolare di 0,30 m
MONTAGGIO	su frutto cieco
DATI FOTOMETRICI	vedi pag. 836

WALL 8

✓
WALL 1
 3000K, 2,5W, satinato, versione speciale con uscita cavo posteriore

Collezione privata, Milano, Italia
 Courtesy of / Susanna Roda



WALL 8.0

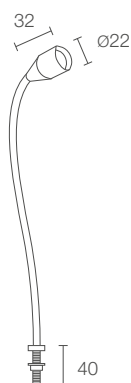

Stelo flessibile:
 Ø8 mm - 400 mm

CE LED ENEC kg 0,16 IP40
 A A+ A++

POTENZA / ALIMENTAZIONE max 2W max 500mA 400 mm
CODICE PL801240 C Cromato
 PL801240 S Satinato

COLORE LED	F - 2700K 5 - 3000K 9 - 4000K 0 - 5000K
OTTICHE	S - 10° M - 25° L - 40°
FLUSSO SORGENTE	145 lm (3000K, 500mA)
FLUSSO EMESSO	103 lm (3000K, 500mA, 25°)
NUMERO E TIPO LED	1 power LED 1/4 ANSI BIN, 50000h L90 B10 (Ta 25°C)
MATERIALE	corpo in alluminio, stelo in ottone
ALIMENTATORE	non incluso, vedi pag. 608 e 844
CAVI DI ALIMENTAZIONE	incluso cavo in PVC di 0,50 m FROR 2x0,35 Ø3,5 mm
COLLEGAMENTO	in serie
MONTAGGIO	su superficie (mensola max 30 mm)
ACCESSORI	vedi pag. 608
DATI FOTOMETRICI	vedi pag. 836



WALL 8.1

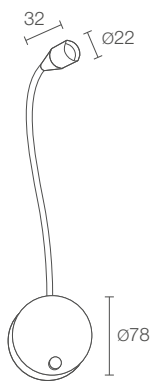

Stelo flessibile:
Ø8 mm - 400 mm

CE LED kg 0,34 IP20

A A+ A++

2,5W 230Vac 400 mm
PL811140 C Cromato
PL811140 S Satinato
 3,5W 230Vac 400 mm
PL811240 C Cromato
PL811240 S Satinato

F - 2700K
 5 - 3000K
 9 - 4000K
 0 - 5000K

S - 10°
 M - 25°
 L - 40°

145 lm (3000K, 3,5W)

103 lm (3000K, 25°, 3,5W)

1 power LED
 1/4 ANSI BIN, 50000h L90 B10 (Ta 25°C)

corpo in alluminio, stelo in ottone
 base in acciaio

integrato con interruttore alla base dello stelo

non previsti

tensione di rete

su superficie (parete)

non previsti

vedi pag. 836



WALL 8.2

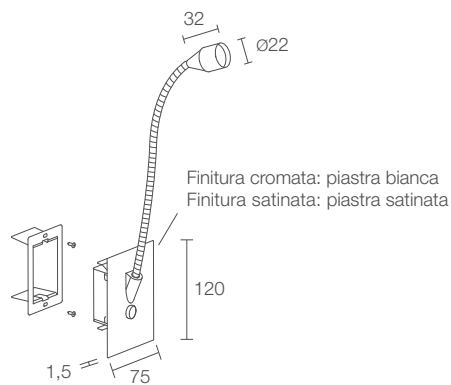

Stelo flessibile:
Ø8 mm - 400 mm

CE LED kg 0,37 IP40

A A+ A++

2,5W 230Vac 400 mm
PL821140 C Cromato
PL821140 S Satinato
 3,5W 230Vac 400 mm
PL821240 C Cromato
PL821240 S Satinato

F - 2700K
 5 - 3000K
 9 - 4000K
 0 - 5000K

S - 10°
 M - 25°
 L - 40°

145 lm (3000K, 3,5W)

103 lm (3000K, 25°, 3,5W)

1 power LED
 1/4 ANSI BIN, 50000h L90 B10 (Ta 25°C)

corpo in alluminio, stelo in ottone
 piastra in acciaio

integrato con interruttore alla base dello stelo

incluso cavo bipolare di 0,30 m

tensione di rete

su superficie (parete)

vedi pag. 608

vedi pag. 836

WALL

ACCESSORI E ALIMENTATORI

ACCESSORI PER INSTALLAZIONE



WC0301

Cassaforma opzionale
(Wall 8.2)

CAVI DI ALIMENTAZIONE

Cavo in PVC
FROR 2x0,35 Ø3,5 mm
lunghezza su richiesta

WF0110

(Wall 8.0)

da ordinare contestualmente all'apparecchio illuminante

ALIMENTATORI Wall 8.0

350mA

N° max prodotti	Alimentatori	IP	Pagina
1/3	A13350VL	20	845
1/15	ACUNI020T1	20	844 845
3/9	A19350QL	20	845
5/12	A312350QL	20	845
1/12 Dimmer	ADUNITC	20	848 849 850

500mA

N° max prodotti	Alimentatori	IP	Pagina
1/3	A13500VL	20	845
1/10	ACUNI020T1	20	844 845
2/5	A15500QL	20	845
5/10	A310500QL	20	845
1/12 Dimmer	ADUNITC	20	848 849 850



WALL

LAMPADE DA LETTURA

WALL 1 3

20° (20°÷55°)

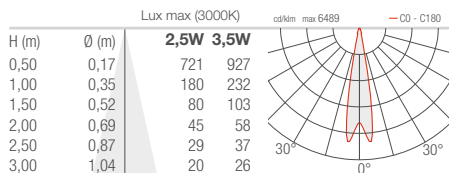

55° (20°÷55°)

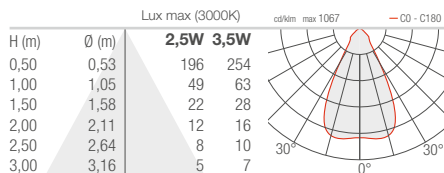

WALL 8.0

S - 10°

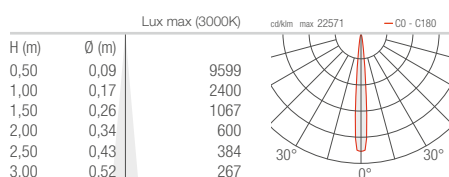

M - 25°

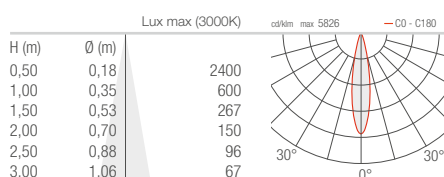

L - 40°

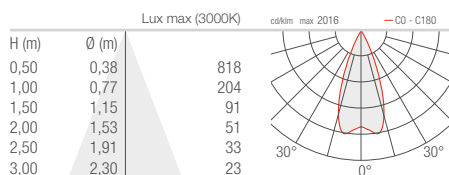

WALL 8.1 8.2

S - 10°

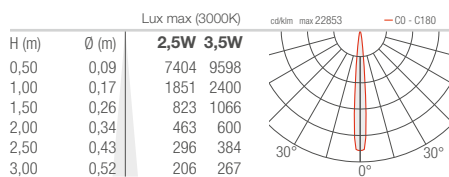

M - 25°

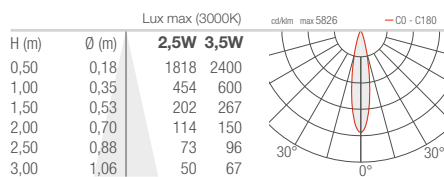

L - 40°

