



LINE

SEGNAPASSI DA INTERNO
ILLUMINAZIONE DI SCALE E CORRIDOI



diffusa



2700K 3000K 4000K 5000K blu

MONTAGGIO A INCASSO
SU PARETE IN MURATURA

MONTAGGIO A INCASSO
SU PARETE IN CARTONGESSO

60x70 mm
max 2W max 500mA



LINE 1.0 p. 658



LINE 1.1 p. 658

55x160 mm
max 2W max 500mA



LINE 2.0 p. 659



LINE 2.1 p. 659

< LINE 1.0
3000K, 2W, satinato

Interior design by / Cristian Turra
Photo by / Alessio Tamborini
Abitazione privata, Brescia, Italia

LINE 1



LINE 1.0

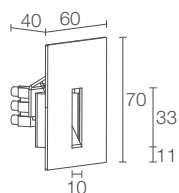

LINE 1.1

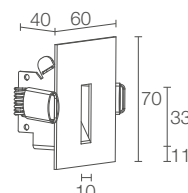

Cassaforma non inclusa obbligatoria

150x150 mm
H 70 mm

38x55 mm

CE LED TECH III kg 0,16 IP20

A A+ A++

CE LED TECH III kg 0,18 IP20

A A+ A++

POTENZA / ALIMENTAZIONE	max 2W max 500mA
CODICE	FL1270 D B Bianco FL1270 D S Satinato FL1270 D T Cor-ten
COLORE LED	F - 2700K 5 - 3000K 9 - 4000K 0 - 5000K 1 - blu
OTTICHE	diffusa
FLUSSO SORGENTE	145 lm (3000K, 500mA)
FLUSSO EMESSO	32 lm (3000K, 500mA)
NUMERO E TIPO LED	1 power LED 1/4 ANSI BIN (colore LED bianco) 50000h L90 B10 (Ta 25°C)
MATERIALE	corpo e copertura in acciaio
ALIMENTATORE	non incluso, vedi pag. 660 e 844
CAVI DI ALIMENTAZIONE	morsettiera
COLLEGAMENTO	in serie
MONTAGGIO	a incasso (parete in muratura)
ACCESSORI	vedi pag. 660
DATI FOTOMETRICI	vedi pag. 779

POTENZA / ALIMENTAZIONE	max 2W max 500mA
CODICE	LN1112 A B Bianco LN1112 A S Satinato LN1112 A T Cor-ten
COLORE LED	F - 2700K 5 - 3000K 9 - 4000K 0 - 5000K 1 - blu
OTTICHE	diffusa
FLUSSO SORGENTE	145 lm (3000K, 500mA)
FLUSSO EMESSO	32 lm (3000K, 500mA)
NUMERO E TIPO LED	1 power LED 1/4 ANSI BIN (colore LED bianco) 50000h L90 B10 (Ta 25°C)
MATERIALE	corpo e copertura in acciaio
ALIMENTATORE	non incluso, vedi pag. 660 e 844
CAVI DI ALIMENTAZIONE	morsettiera
COLLEGAMENTO	in serie
MONTAGGIO	a incasso (parete in cartongesso)
ACCESSORI	non previsti
DATI FOTOMETRICI	vedi pag. 779

LINE 2



LINE 2.0

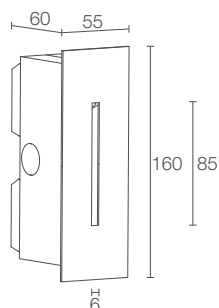

LINE 2.1

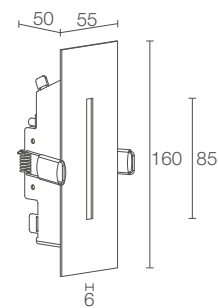

Cassaforma non inclusa obbligatoria

150x210 mm
H 70 mm

45x125 mm

CE LED TECH III kg 0,21 IP20

A A+ A++

CE LED TECH III kg 0,32 IP20

A A+ A++

POTENZA / ALIMENTAZIONE max 2W max 500mA
CODICE

LN2012 **A B** Bianco
LN2012 **A S** Satinato
LN2012 **A T** Cor-ten

COLORE LED
F - 2700K
5 - 3000K
9 - 4000K
0 - 5000K
1 - blu

OTTICHE diffusa

FLUSSO SORGENTE 145 lm (3000K, 500mA)

FLUSSO EMESSO 42 lm (3000K, 500mA)

NUMERO E TIPO LED
1 power LED
1/4 ANSI BIN (colore LED bianco)
50000h L90 B10 (Ta 25°C)

MATERIALE corpo e copertura in acciaio

ALIMENTATORE non incluso, vedi pag. 660 e 844

CAVI DI ALIMENTAZIONE morsettiera

COLLEGAMENTO in serie

MONTAGGIO a incasso (parete in muratura)

ACCESSORI vedi pag. 660

DATI FOTOMETRICI vedi pag. 779

max 2W max 500mA

LN2112 **A B** Bianco
LN2112 **A S** Satinato
LN2112 **A T** Cor-ten

COLORE LED
F - 2700K
5 - 3000K
9 - 4000K
0 - 5000K
1 - blu

OTTICHE diffusa

FLUSSO SORGENTE 145 lm (3000K, 500mA)

FLUSSO EMESSO 42 lm (3000K, 500mA)

NUMERO E TIPO LED
1 power LED
1/4 ANSI BIN (colore LED bianco)
50000h L90 B10 (Ta 25°C)

MATERIALE corpo e copertura in acciaio

ALIMENTATORE non incluso, vedi pag. 660 e 844

CAVI DI ALIMENTAZIONE morsettiera

COLLEGAMENTO in serie

MONTAGGIO a incasso (parete in cartongesso)

ACCESSORI non previsti

DATI FOTOMETRICI vedi pag. 779

LINE

ACCESSORI E ALIMENTATORI

ACCESSORI PER INSTALLAZIONE

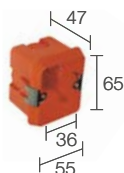

WC0300

Cassaforma per muratura
(Line 1.0)

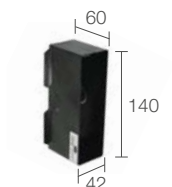

WC1600

Cassaforma per muratura
(Line 2.0)

ALIMENTATORI

350mA

N° max prodotti	Alimentatori	IP	Pagina
1/3	A13350VL	20	845
1/15	ACUNI020T1	20	844 845
3/9	A19350QL	20	845
5/12	A312350QL	20	845
1/12 Dimmer	ADUNITC	20	848 849 850

500mA

N° max prodotti	Alimentatori	IP	Pagina
1/3	A13500TC	20	845
1/10	ACUNI020T1	20	844 845
2/5	A15500QL	20	845
5/10	A310500QL	20	845
1/12 Dimmer	ADUNITC	20	848 849 850

SCHEMI DI POSIZIONAMENTO

LINE 1.0 / 1.1

D - Diffuso

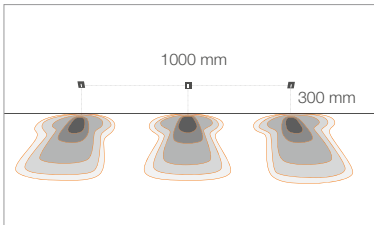
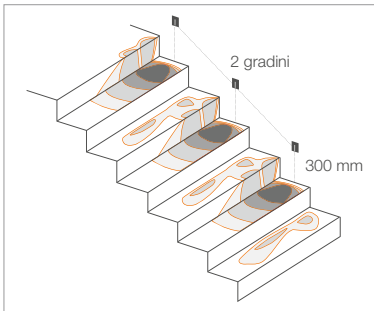

LINE 2.0 / 2.1

D - Diffuso

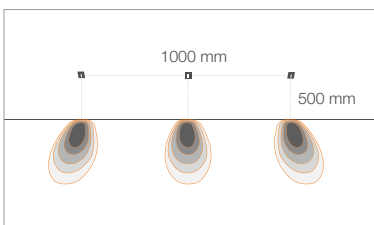
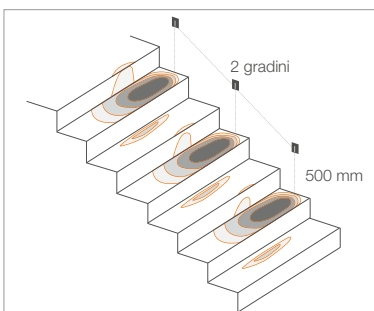

LINE

SEGNAPASSI DA INTERNO

LINE 1.0 1.1

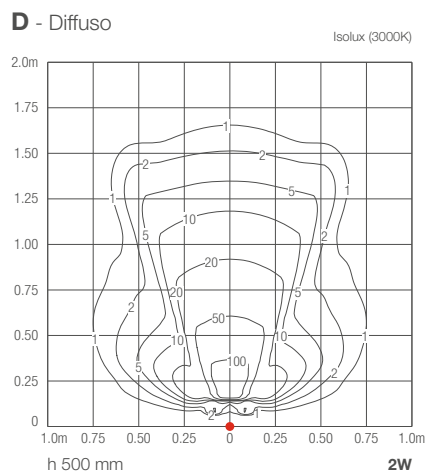
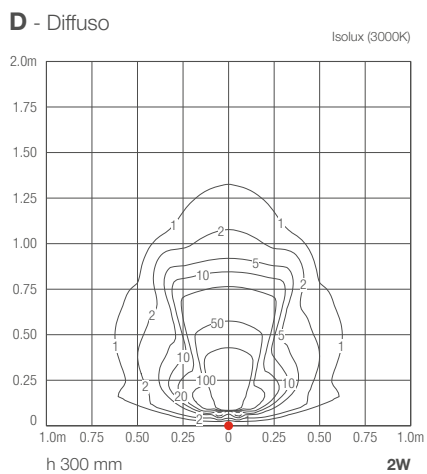

LINE 2.0 2.1

