



INTONO C OUT

PLAFONIERE DA ESTERNO CON SOLA EMISSIONE LUMINOSA O CON CASSA AUDIO PER CONTESTI RESIDENZIALI E HOSPITALITY



stretta

media

larga

diffusa

asimmetrica



2700K 3000K 4000K

ESTERNO

INTERNO

PLAFONIERE

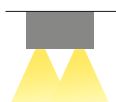

INTONO C OUT 2.4 p. 376
12W 230Vac
ON/OFF

INTONO C IN p. 644



INTONO C OUT 3.4 p. 377
20W 230Vac
ON/OFF, DALI, 0/1-10V

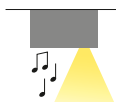

INTONO C OUT 3.9 p. 377
9W 24Vdc

APPLIQUE

INTONO p. 324



^ INTONO C OUT 3.9

cassa audio:
potenza massima
impedenza nominale Z
livello medio di pressione sonora

3W
16 Ohm
86 dB (1W/1m)

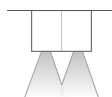
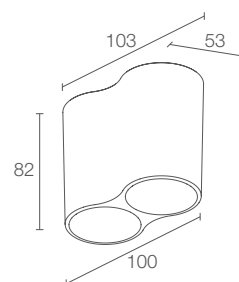

INTONO C OUT 2.4

CE LED TECH kg 0,60 IP65 IK06
A+ A+ A++

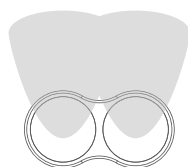

Ottica asimmetrica
(Intono C OUT 3.4)

POTENZA / ALIMENTAZIONE 12W 230Vac
CODICE
NC2410 00 E Bianco
NC2410 00 F Grigio
NC2410 00 H Antracite
NC2410 00 T Cor-ten
NC2410 00 7 Primer

CRI
0 - CRI 80
1 - CRI >90

GESTIONE DI CONTROLLO on/off

NIDO D'APE
0 - non presente
1 - presente
(non applicabile sull'ottica diffusa)

COLORE LED
F - 2700K
5 - 3000K
9 - 4000K

OTTICHE
TT - 11°
MM - 34°
KK - 68°
DD - diffusa

FLUSSO SORGENTE 976 lm (3000K, CRI 80)

FLUSSO EMESSO 704 lm (3000K, 34°, CRI 80)

NUMERO E TIPO LED
2 power LED
3 step MacAdam, 50000h L90 B10 (Ta 25°C)

MATERIALE
corpo in alluminio pressofuso
schermo in vetro extrachiaro temprato trasparente
e serigrafato nero

ALIMENTATORE integrato

MONTAGGIO su superficie (soffitto)

ACCESSORI non previsti

NOTE
versione da interno Intono C IN 2.3 pag. 646
versione applique Intono pag. 324
su richiesta versione compatibile con Google Home o
Amazon Echo per controllo tramite comandi vocali
su richiesta disponibile la versione con gestione
Casambi, controllabile tramite app Casambi

DATI FOTOMETRICI vedi pag. 839

v INTONO C OUT 3.4

versione primer verniciata



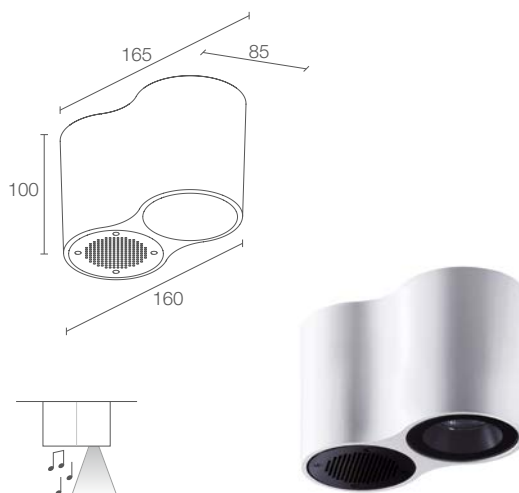
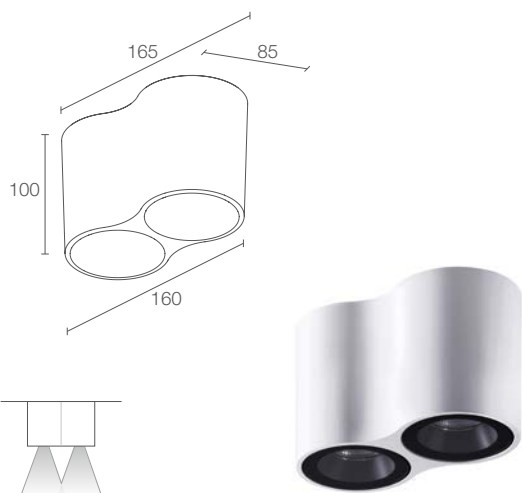

INTONO C OUT 3.4

CE LED TECH kg 1,35 IP65 IK06 DALI 0/1-10V
A A+ A++

20W 230Vac

NC3410 0 1 2 3 4 5 6 7 8 9 E Bianco
NC3410 0 1 2 3 4 5 6 7 8 9 F Grigio
NC3410 0 1 2 3 4 5 6 7 8 9 H Antracite
NC3410 0 1 2 3 4 5 6 7 8 9 T Cor-ten
NC3410 0 1 2 3 4 5 6 7 8 9 7 Primer

0 - CRI 80
1 - CRI >90

0 - on/off
D - DALI
R - 0/1-10V

0 - non presente
1 - presente
(non applicabile sull'ottica asimmetrica)

F - 2700K
5 - 3000K
9 - 4000K

SS - 15°
MM - 20°
LL - 43°
AA - asimmetrica

1976 lm (3000K, CRI 80)

1674 lm (3000K, 15°, CRI 80)

2 COB LED High Density
2 step MacAdam, 50000h L95 B10 (Ta 25°C)

corpo in alluminio pressofuso
schermo in vetro extrachiaro temprato trasparente
e serigrafato nero

integrato

su superficie (soffitto)

non previsti

versione da interno Intono C IN 3.3 pag. 647
versione applique Intono pag. 324
su richiesta versione compatibile con Google Home o
Amazon Echo per controllo tramite comandi vocali
su richiesta disponibile la versione con gestione
Casambi, controllabile tramite app Casambi

vedi pag. 839

INTONO C OUT 3.9

CE LED TECH kg 1,35 IP65 IK06
A A+ A++

9W 24Vdc

NC3900 00 01 02 03 04 05 06 07 08 09 M9 E Bianco
NC3900 00 01 02 03 04 05 06 07 08 09 M9 F Grigio
NC3900 00 01 02 03 04 05 06 07 08 09 M9 H Antracite
NC3900 00 01 02 03 04 05 06 07 08 09 M9 T Cor-ten
NC3900 00 01 02 03 04 05 06 07 08 09 M9 7 Primer

0 - CRI 80
1 - CRI >90

0 - non presente
1 - presente

F - 2700K
5 - 3000K
9 - 4000K

20°

988 lm (3000K, CRI 80)

783 lm (3000K, 20°, CRI 80)

1 COB LED High Density
2 step MacAdam, 50000h L95 B10 (Ta 25°C)

corpo in alluminio pressofuso
schermo in vetro extrachiaro temprato trasparente
e serigrafato nero

non incluso, vedi pag. 904

su superficie (soffitto)

vedi pag. 378

versione da interno Intono C IN 3.8 pag. 647
versione applique Intono pag. 324
su richiesta versione compatibile con Google Home o
Amazon Echo per controllo tramite comandi vocali
su richiesta disponibile la versione con gestione
Casambi, controllabile tramite app Casambi

vedi pag. 839



ACCESSORI



WUNT39A00

Kit controller audio bluetooth 3.0
con alimentatore e amplificatore
(per sistema controllo vocale
Alexa o Google Home)
(Intono C OUT 3.9)



WUNT39A01

Kit controller luce Wi-Fi
(Intono C OUT 3.9)

∨
INTONO C OUT 3.4
20W, ottica asimmetrica



ACCESSORI

✓
INTONO C OUT 3.4
20W, ottica asimmetrica



INTONO C IN 2.3 INTONO C OUT 2.4

TT - 11° CRI 80

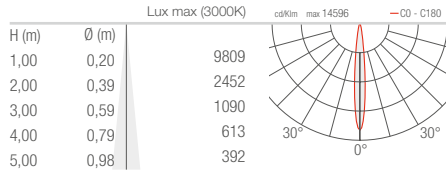

MM - 34° CRI 80

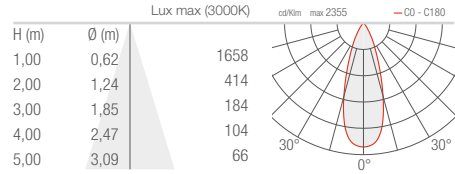

KK - 68° CRI 80

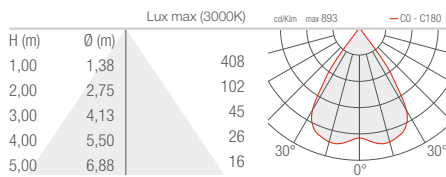

DD - Diffusa CRI 80

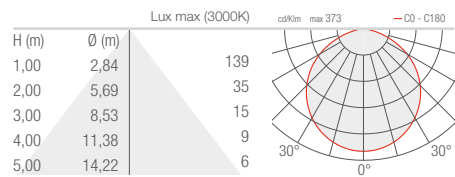

INTONO C IN 3.3 INTONO C OUT 3.4

SS - 15° CRI 80

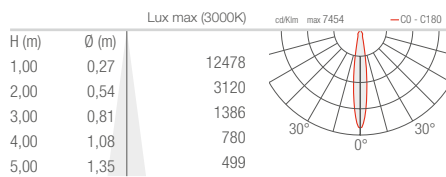

MM - 20° CRI 80

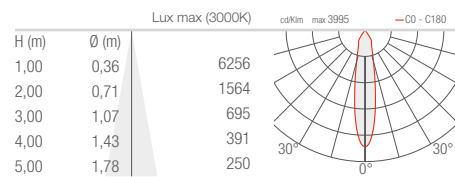

LL - 43° CRI 80

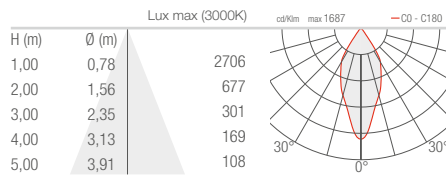

AA - Asimmetrica CRI 80

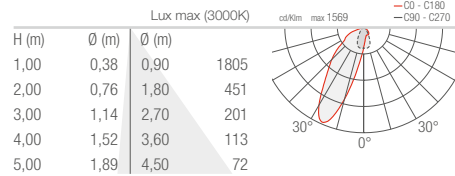

INTONO C IN 3.8 INTONO C OUT 3.9

M - 20° CRI 80

