



550

L&L Luce&Light



DUOMO

INDOOR PROJECTORS
ARCHITECTURAL LIGHTING FOR NAVES AND ARCADES

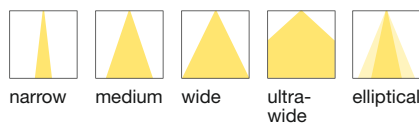

DUOMO 1.0 p. 554
10W 230Vac
ON/OFF



DUOMO 2.0 p. 554
19W 230Vac
ON/OFF



DUOMO 3.0 p. 555
28W 230Vac
ON/OFF
DALI



DUOMO 4.0 p. 555
56W 230Vac
ON/OFF
DALI

DUOMO'S ADJUSTABLE BRACKET
MEANS THE FIXTURE CAN BE
CANTILEVERED FROM CORNICES OR
OTHER ARCHITECTURAL ELEMENTS

ANTI-GLARE
RECESSED OPTICS



ANTIQUÉ WHITE FINISH
TO VISUALLY INTEGRATE
THE LIGHTING FIXTURE
INTO HISTORIC BUILDINGS



DUOMO

UNIQUE SELLING POINTS

BUILT-IN
PROTECTION
SYSTEMS:



PID
PROTECTIVE
IMPEDANCE
DEVICE

DIMMING WITH DALI, 1-10V
OR PUSH, OR WITH BLUETOOTH
CONTROL, ON REQUEST

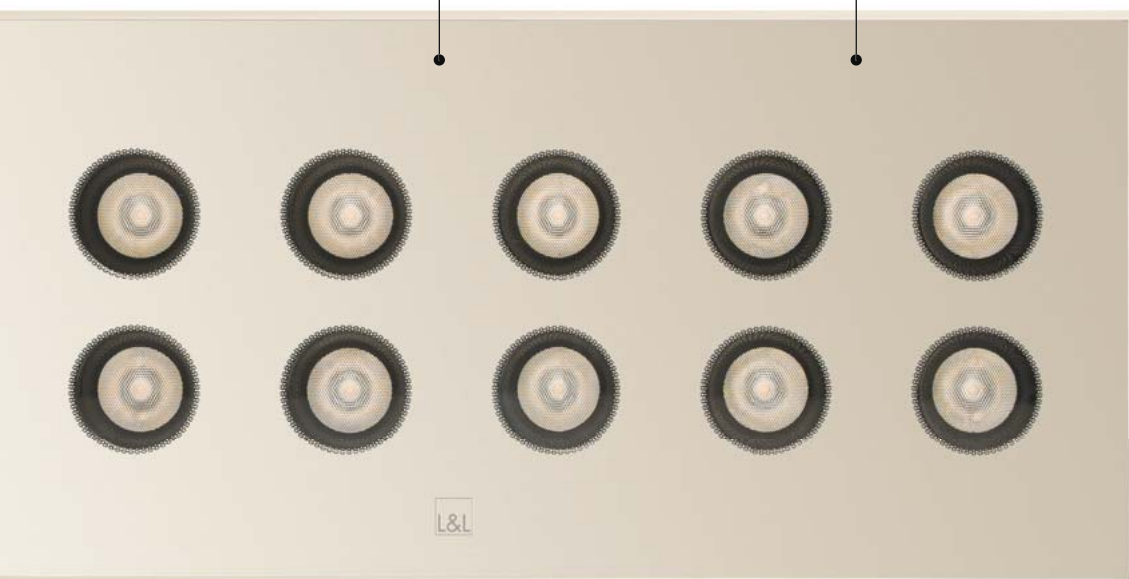

IK06

SERIGRAPHED, TEMPERED
EXTRA-CLEAR GLASS

IP54

SUITABLE FOR INSTALLATION IN
CLOISTERS AND COLONADES

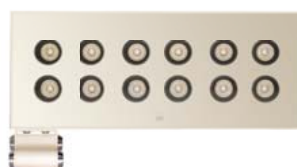
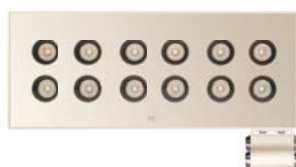

THE BRACKET CAN SLIDE
ALONG THE ENTIRE LENGTH
OF THE HEAD, ALLOWING THE
PROJECTOR TO BE INSTALLED
AND ANGLED IN TIGHT SPACES

DUOMO

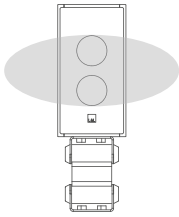

18°x44° optics



DUOMO 1.0



DUOMO 2.0



44°x18° optics

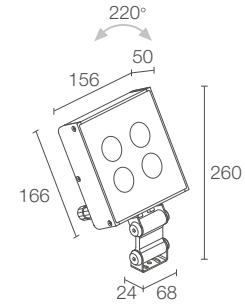
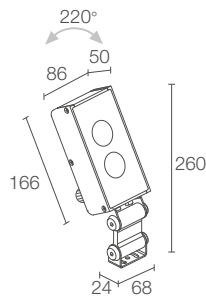

POWER / POWER SUPPLY CODE

10W 230Vac ON/OFF
DU1010 00 0 0 6 Antique white
DU1010 00 0 0 E White
DU1010 00 0 0 H Anthracite

19W 230Vac ON/OFF
DU2010 00 0 0 6 Antique white
DU2010 00 0 0 E White
DU2010 00 0 0 H Anthracite

CRI	0 - CRI 80 1 - CRI >90
HONEYCOMB LOUVRE	0 - not present 1 - present (not compatible with the 10° optics)
LED COLOUR	F - 2700K 5 - 3000K 9 - 4000K
OPTICS	T - 10° J - 43° S - 14° K - 63° M - 30° W - 18°x44° L - 35° X - 44°x18°
LUMEN OUTPUT AT SOURCE	880 lm (3000K, CRI 80)
DELIVERED LUMEN OUTPUT	714 lm (3000K, 30°, CRI 80)
NO. AND TYPE OF LED	2 high intensity power LEDs 3-step MacAdam, 50000h L90 B10 (Ta 25°C)
MATERIAL	body and bracket in Anticorodal® aluminium screen in serigraphed, tempered, extra-clear glass
POWER SUPPLY UNIT	built in
MOUNTING	surface mounted (ceiling, wall, floor)
ACCESSORIES	see p. 556
FEATURES	electrical wiring simplified by the ability to connect the electrical cables directly to the connector
NOTES	available on request with adapter for Eurostandard track and in DALI, 1-10V or PUSH version, or with Bluetooth control
PHOTOMETRIC DATA	see p. 754

CRI	0 - CRI 80 1 - CRI >90
HONEYCOMB LOUVRE	0 - not present 1 - present (not compatible with 10° optics)
LED COLOUR	F - 2700K 5 - 3000K 9 - 4000K
OPTICS	T - 10° J - 43° S - 14° K - 63° M - 30° W - 18°x44° L - 35° X - 44°x18°
LUMEN OUTPUT AT SOURCE	1760 lm (3000K, CRI 80)
DELIVERED LUMEN OUTPUT	1428 lm (3000K, 30°, CRI 80)
NO. AND TYPE OF LED	4 high intensity power LEDs 3-step MacAdam, 50000h L90 B10 (Ta 25°C)
MATERIAL	body and bracket in Anticorodal® aluminium screen in serigraphed, tempered, extra-clear glass
POWER SUPPLY UNIT	built in
MOUNTING	surface mounted (ceiling, wall, floor)
ACCESSORIES	see p. 556
FEATURES	electrical wiring simplified by the ability to connect the electrical cables directly to the connector
NOTES	available on request with adapter for Eurostandard track and in DALI, 1-10V or PUSH version, or with Bluetooth control
PHOTOMETRIC DATA	see p. 754 and 755



DUOMO 3.0

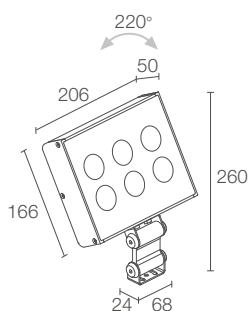

DUOMO 4.0

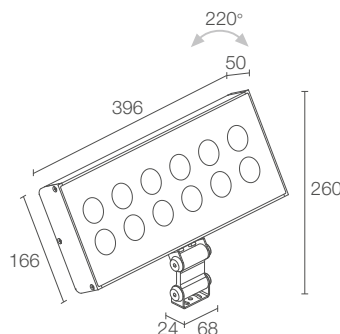

28W 230Vac ON/OFF

- DU3010** 00 0 0 6 Antique white
- DU3010** 00 0 0 E White
- DU3010** 00 0 0 H Anthracite

28W 230Vac DALI

- DU3010** D0 0 0 6 Antique white
- DU3010** D0 0 0 E White
- DU3010** D0 0 0 H Anthracite

56W 230Vac ON/OFF

- DU4010** 00 0 0 6 Antique white
- DU4010** 00 0 0 E White
- DU4010** 00 0 0 H Anthracite

56W 230Vac DALI

- DU4010** D0 0 0 6 Antique white
- DU4010** D0 0 0 E White
- DU4010** D0 0 0 H Anthracite

0	CRI 80
1	CRI >90
0	not present
1	present (not compatible with 10° optics)
F	2700K
5	3000K
9	4000K
T	10°
S	14°
M	30°
L	35°
J	43°
K	63°
W	18°x44°
X	44°x18°
2640 lm (3000K, CRI 80)	
2142 lm (3000K, 30°, CRI 80)	
6 high intensity power LEDs 3-step MacAdam, 50000h L90 B10 (Ta 25°C)	
body and bracket in Anticorodal® aluminium screen in serigraphed, tempered, extra-clear glass	
built in	
surface mounted (ceiling, wall, floor)	
see p. 556	
electrical wiring simplified by the ability to connect the electrical cables directly to the connector	
available on request with adapter for Eurostandard track and in 1-10V or PUSH version, or with Bluetooth control	
see p. 755	

0	CRI 80
1	CRI >90
0	not present
1	present (not compatible with 10° optics)
F	2700K
5	3000K
9	4000K
T	10°
S	14°
M	30°
L	35°
J	43°
K	63°
W	18°x44°
X	44°x18°
5280 lm (3000K, CRI 80)	
4284 lm (3000K, 30°, CRI 80)	
12 high intensity power LEDs 3-step MacAdam, 50000h L90 B10 (Ta 25°C)	
body and bracket in Anticorodal® aluminium screen in serigraphed, tempered, extra-clear glass	
built in	
surface mounted (ceiling, wall, floor)	
see p. 556	
electrical wiring simplified by the ability to connect the electrical cables directly to the connector	
available on request with adapter for Eurostandard track and in 1-10V or PUSH version, or with Bluetooth control	
see p. 756	

DUOMO

ACCESSORIES

ACCESSORIES



WF0316

3-pin female connector
for in/out connection
(on/off version)
(Duomo 2.0 / 3.0 / 4.0)

WF0317

5-pin female connector
for in/out connection
(DALI version)
(Duomo 3.0 / 4.0)

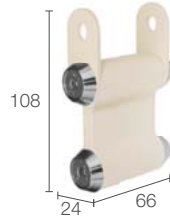

WMA006 - Antique white

WMA00E - White

WMA00H - Anthracite

Adjustable bracket

Easy to wire because electrical
cables can be connected
directly to the connector

In/out connection possible





DUOMO

INDOOR PROJECTORS

DUOMO 1.0

T - 10° CRI 80

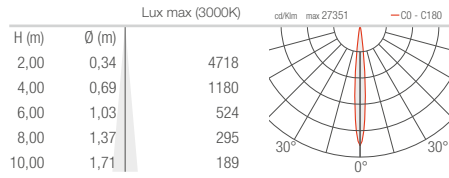

S - 14° CRI 80

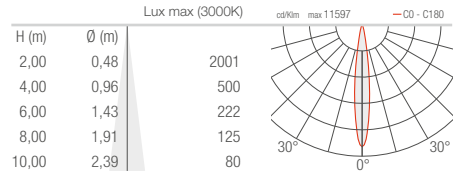

M - 30° CRI 80

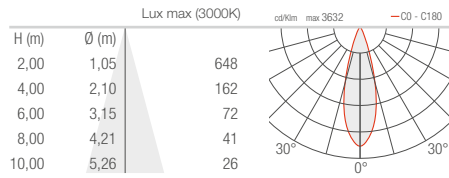

L - 35° CRI 80

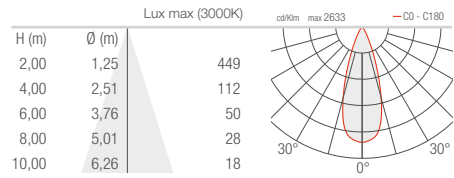

J - 43° CRI 80

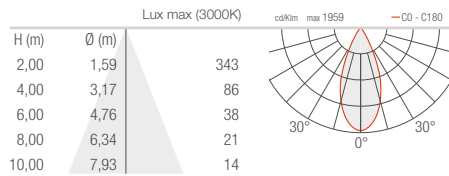

K - 63° CRI 80

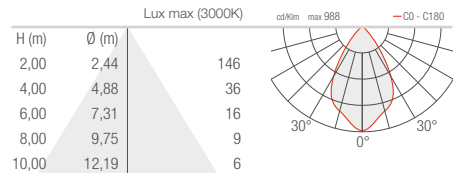

W - 18°x44° CRI 80

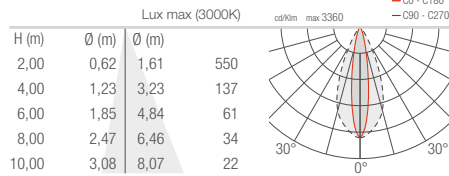

X - 44°x18° CRI 80

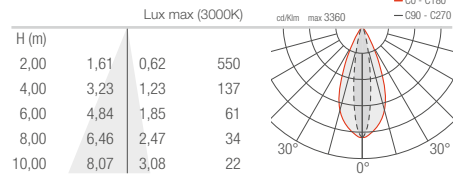

DUOMO 2.0

T - 10° CRI 80

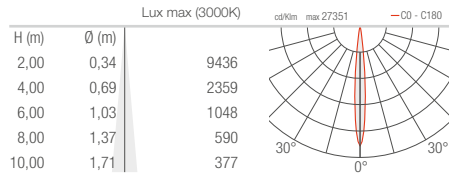

S - 14° CRI 80

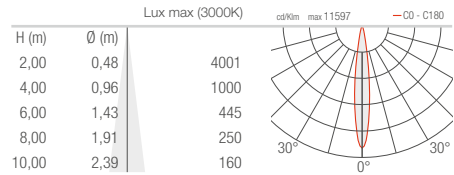

M - 30° CRI 80

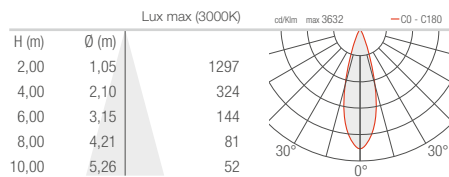

L - 35° CRI 80

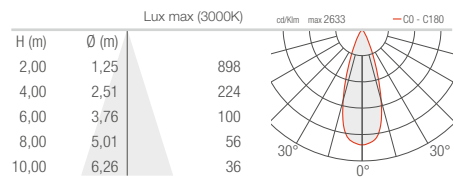



DUOMO 2.0

J - 43° CRI 80

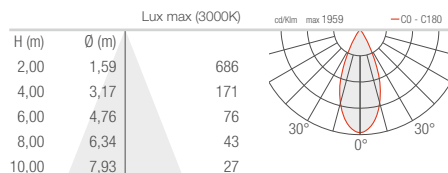

K - 63° CRI 80

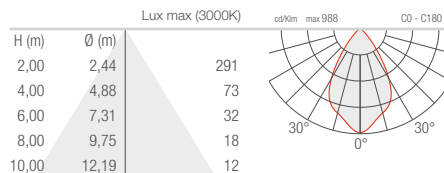

W - 18°x44° CRI 80

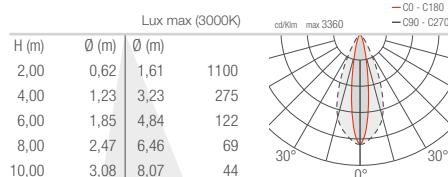

X - 44°x18° CRI 80

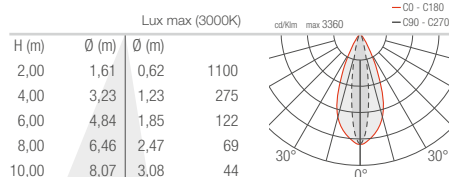

DUOMO 3.0

T - 10° CRI 80

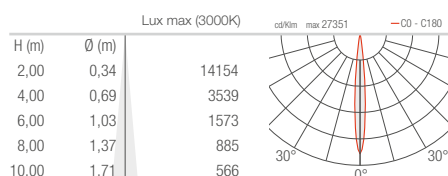

S - 14° CRI 80

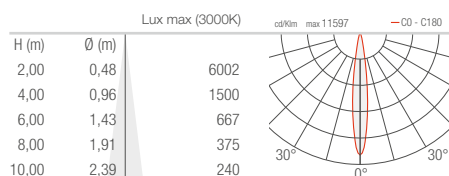

M - 30° CRI 80

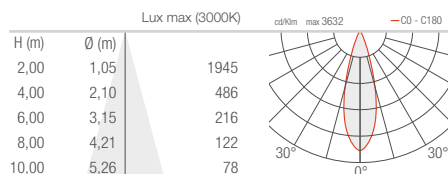

L - 35° CRI 80

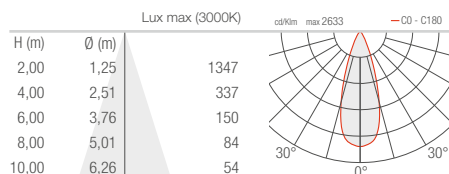

J - 43° CRI 80

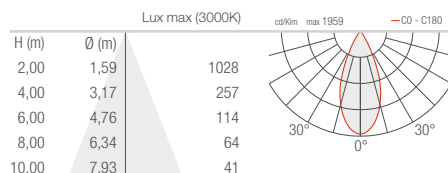

K - 63° CRI 80

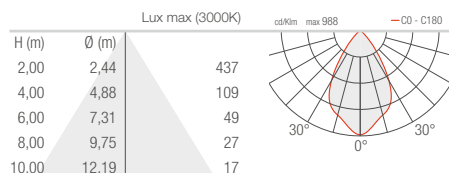

W - 18°x44° CRI 80

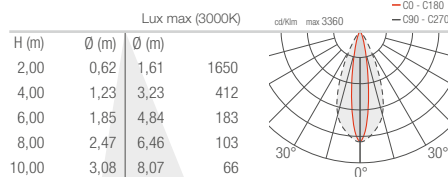

X - 44°x18° CRI 80

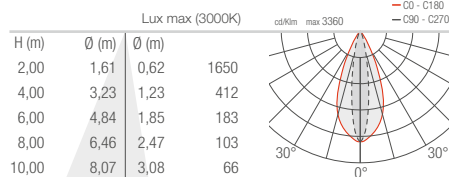

DUOMO 4.0

T - 10° CRI 80

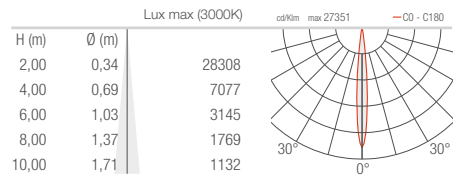

S - 14° CRI 80

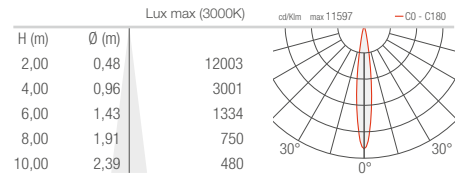

M - 30° CRI 80

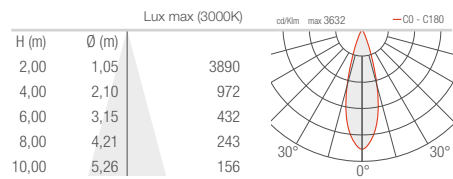

L - 35° CRI 80

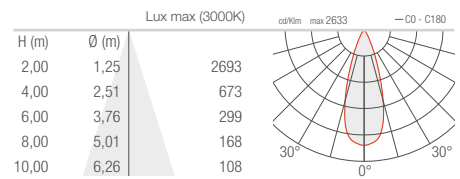

J - 43° CRI 80

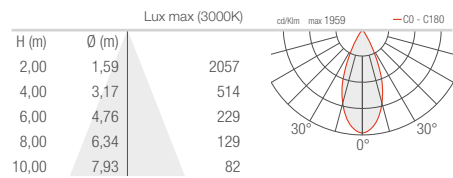

K - 63° CRI 80

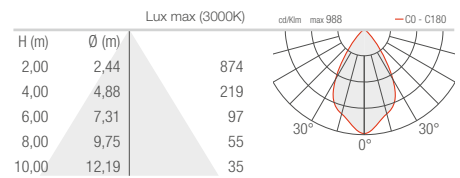

W - 18°x44° CRI 80

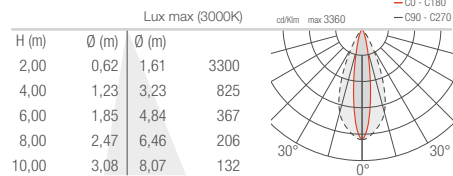

X - 44°x18° CRI 80

