

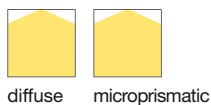

BRENTA

INDOOR LINEAR PROFILES
FOR LINES OF CONTINUOUS LIGHT

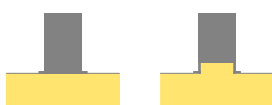

2700K 3000K 4000K

WIDTH 42 mm

WIDTH 70 mm

STANDARD LENGTHS

562 mm

842 mm

1122 mm

1682 mm

2242 mm

2802 mm



BRENTA 1 p. 638
19W/m 230Vac
27W/m 230Vac



BRENTA 2 p. 640
27W/m 230Vac
54W/m 230Vac

CUSTOM LENGTHS

5000 mm

10000 mm

15000 mm



BRENTA 1 CUSTOM p. 642
19W/m 230Vac
27W/m 230Vac



BRENTA 2 CUSTOM p. 642
27W/m 230Vac
54W/m 230Vac



THANKS TO THE OUTER CASING, INSTALLATION IS QUICK, WHILE PRESERVING THE INTEGRITY OF THE CEILING

CRI >90

BRENTA USES LIGHT SOURCES WITH A HIGH COLOUR RENDERING INDEX

BRENTA 1 / 2 AVAILABLE IN 6 LENGTHS

BRENTA CUSTOM AVAILABLE WITH SCREEN OF UP TO 15 METERS, L-SHAPED VERSIONS AND BESPOKE LENGTHS

BRENTA

UNIQUE SELLING POINTS

THE IN/OUT CABLE
CONNECTION
MAKES WIRING
MUCH EASIER

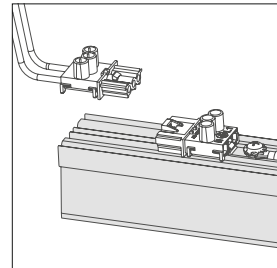

THE MAGNETIC
FASTENER ELIMINATES
THE NEED FOR
SCREWS AND
SIMPLIFIES
INSTALLATION

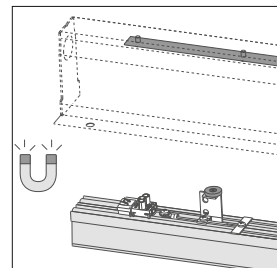

USING THE DIFFERENT
OUTER CASINGS,
BRENTA CAN BE
INSTALLED FLUSH
WITH THE CEILING
OR DEEP SET

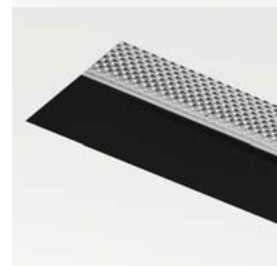

HONEYCOMB LOUVRE
ACCESSORY CAN
BE FITTED ON
BRENTA WITH DIFFUSE
OPTICS AND DEEP-SET
INSTALLATION



BRENTA 1

∇
BRENTA 1
flush installation



∧
BRENTA 1
deep-set installation

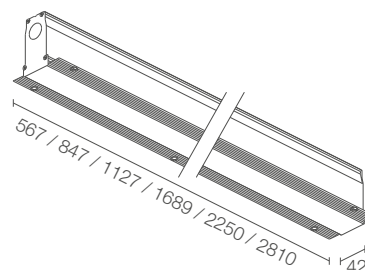

Required outer casing, not included
Required screen, not included

CE LED flush kg/m 2.26 deep set kg/m 2.40 IP40 A A+ A++

POWER SUPPLY	230Vac	
POWER	19W/m 11W (562 mm) 16W (842 mm) 22W (1122 mm) 33W (1682 mm) 43W (2242 mm) 54W (2802 mm)	27W/m 15W (562 mm) 23W (842 mm) 30W (1122 mm) 46W (1682 mm) 61W (2242 mm) 76W (2802 mm)
LUMEN OUTPUT AT SOURCE	19W/m, 3000K 1780 lm/m	27W/m, 3000K 2500 lm/m
DELIVERED LUMEN OUTPUT	19W/m, 3000K, diffuse optics 1100 lm/m (flush installation) 750 lm/m (deep-set installation) 19W/m, 3000K, microprismatic optics 1000 lm/m (flush installation) 800 lm/m (deep-set installation)	27W/m, 3000K, diffuse optics 1550 lm/m (flush installation) 1050 lm/m (deep-set installation) 27W/m, 3000K, microprismatic optics 1400 lm/m (flush installation) 1100 lm/m (deep-set installation)
NO. AND TYPE OF LED	48 mid-power LEDs (562 mm) 3-step MacAdam, 50000h L90 B10 (Ta 25°C) 72 mid-power LEDs (842 mm) 3-step MacAdam, 50000h L90 B10 (Ta 25°C) 96 mid-power LEDs (1122 mm) 3-step MacAdam, 50000h L90 B10 (Ta 25°C) 144 mid-power LEDs (1682 mm) 3-step MacAdam, 50000h L90 B10 (Ta 25°C) 192 mid-power LEDs (2242 mm) 3-step MacAdam, 50000h L90 B10 (Ta 25°C) 240 mid-power LEDs (2802 mm) 3-step MacAdam, 50000h L90 B10 (Ta 25°C)	
MATERIAL	body in aluminium screen in opal polycarbonate (diffuse version) screen in microprismatic polycarbonate (microprismatic version)	
POWER SUPPLY UNIT	built in	
POWER CABLES	terminal block	
MOUNTING	recessed (ceiling, wall)	
FEATURES	CRI >90	
NOTES	Brenta Custom, see p. 642	
PHOTOMETRIC DATA	see p. 730	

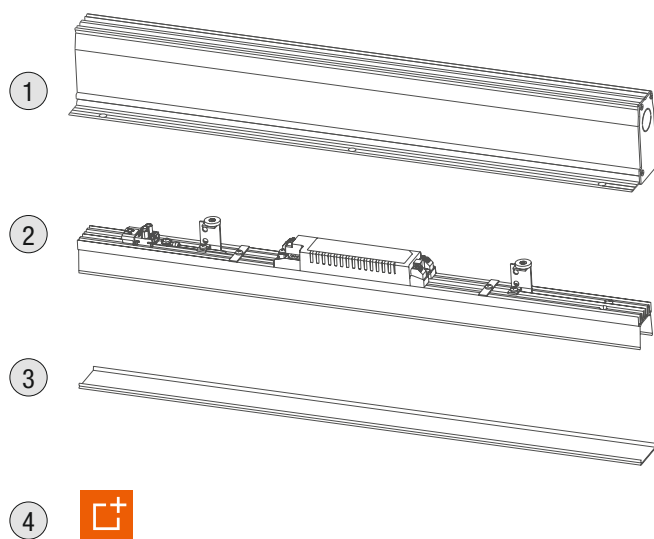

1

OUTER CASING

WCBR11F - 567 mm
WCBR12F - 847 mm
WCBR13F - 1127 mm
WCBR15F - 1689 mm
WCBR17F - 2250 mm
WCBR19F - 2810 mm

Outer casing for **flush installation**
h 80 mm

WCBR11A - 567 mm
WCBR12A - 847 mm
WCBR13A - 1127 mm
WCBR15A - 1689 mm
WCBR17A - 2250 mm
WCBR19A - 2810 mm

Outer casing for **deep-set installation** – black
h 95 mm

WCBR190PF - flush installation
WCBR190PA - deep-set installation

Horizontal L-shaped
outer casing
588x620 mm

WCBR190SF - flush installation
WCBR190SA - deep-set installation

Vertical L-shaped
outer casing
644x644 mm

2

LIGHTING FIXTURE

CODE
DALI 27W/m
BR1 ■ 111 ■ 0BD
ON/OFF
BR1 ■ 1 ■ 1 ■ 0B0

■ **LENGTH**
1 - 562 mm
2 - 842 mm
3 - 1122 mm
5 - 1682 mm
7 - 2242 mm
9 - 2802 mm

■ **POWER**
0 - 19W/m
1 - 27W/m

■ **LED COLOUR**
F - 2700K
5 - 3000K
9 - 4000K

3

SCREEN

WRBR11D - 563 mm
WRBR12D - 843 mm
WRBR13D - 1123 mm
WRBR15D - 1685 mm
WRBR17D - 2246 mm
WRBR19D - 2806 mm

Diffuse
optics

WRBR11P - 563 mm
WRBR12P - 843 mm
WRBR13P - 1123 mm
WRBR15P - 1685 mm
WRBR17P - 2246 mm
WRBR19P - 2806 mm

Microprismatic
optics

4

ACCESSORIES

WHBR1000
Honeycomb louvre
562 mm version:
4 pieces honeycomb louvre
842 mm version:
6 pieces honeycomb louvre
1122 mm version:
8 pieces honeycomb louvre
1682 mm version:
12 pieces honeycomb louvre
2242 mm version:
16 pieces honeycomb louvre
2802 mm version:
20 pieces honeycomb louvre
The honeycomb louvre can be fitted
on diffuse optics and with outer
casing for deep-set installation

WABR101A
Alignment kit for
outer casings

WF0321
Five-pin female connector

WUBR1000
Casing filler kit

WNBR001A
Anti-fall kit for outer casings:
WCBR15F, WCBR15A
WCBR17F, WCBR17A
WCBR19F, WCBR19A

for spare parts, see p. 866

BRENTA 2

∨
BRENTA 2
flush installation

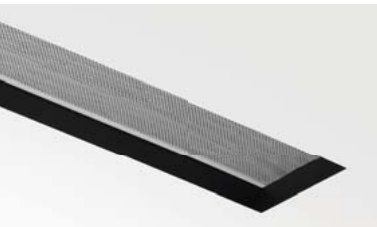

^
BRENTA 2
deep-set installation

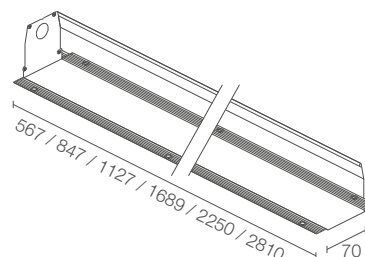

Required outer casing, not included
Required screen, not included

CE LED flush kg/m 3.25 deep set kg/m 3.38 IP40 A A+ A++

POWER SUPPLY	230Vac	
POWER	27W/m 15W (562 mm) 23W (842 mm) 30W (1122 mm) 46W (1682 mm) 61W (2242 mm) 76W (2802 mm)	54W/m 30W (562 mm) 46W (842 mm) 61W (1122 mm) 91W (1682 mm) 122W (2242 mm) 153W (2802 mm)
LUMEN OUTPUT AT SOURCE	27W/m, 3000K 2500 lm/m	54W/m, 3000K 5000 lm/m
DELIVERED LUMEN OUTPUT	27W/m, 3000K, diffuse optics 1550 lm/m (flush installation) 1200 lm/m (deep-set installation) 27W/m, 3000K, microprismatic optics 1500 lm/m (flush installation) 1350 lm/m (deep-set installation)	54W/m, 3000K, diffuse optics 3100 lm/m (flush installation) 2450 lm/m (deep-set installation) 54W/m, 3000K, microprismatic optics 3000 lm/m (flush installation) 2700 lm/m (deep-set installation)
NO. AND TYPE OF LED	96 mid-power LEDs (562 mm) 3-step MacAdam, 50000h L90 B10 (Ta 25°C) 144 mid-power LEDs (842 mm) 3-step MacAdam, 50000h L90 B10 (Ta 25°C) 192 mid-power LEDs (1122 mm) 3-step MacAdam, 50000h L90 B10 (Ta 25°C) 288 mid-power LEDs (1682 mm) 3-step MacAdam, 50000h L90 B10 (Ta 25°C) 384 mid-power LEDs (2242 mm) 3-step MacAdam, 50000h L90 B10 (Ta 25°C) 480 mid-power LEDs (2802 mm) 3-step MacAdam, 50000h L90 B10 (Ta 25°C)	
MATERIAL	body in aluminium screen in opal polycarbonate (diffuse version) screen in microprismatic polycarbonate (microprismatic version)	
POWER SUPPLY UNIT	built in	
POWER CABLES	terminal block	
MOUNTING	recessed (ceiling, wall)	
FEATURES	CRI >90	
NOTES	Brenta Custom, see p. 642	
PHOTOMETRIC DATA	see p. 730	

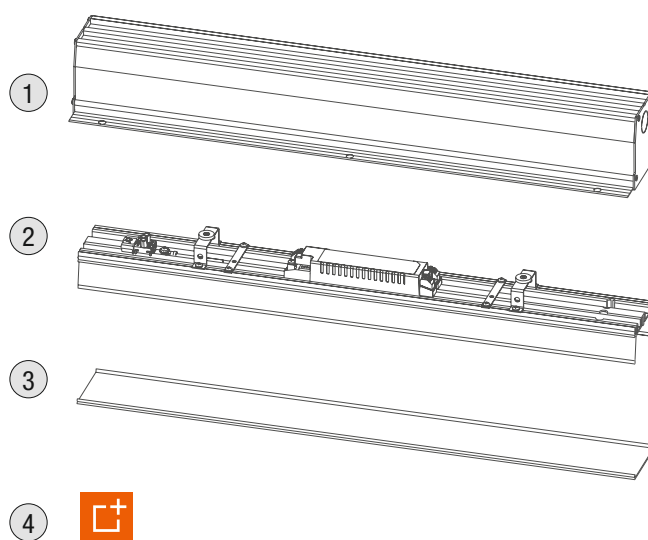

1	2	3	4
OUTER CASING	LIGHTING FIXTURE	SCREEN	ACCESSORIES
<p>WCBR21F - 567 mm WCBR22F - 847 mm WCBR23F - 1127 mm WCBR25F - 1689 mm WCBR27F - 2250 mm WCBR29F - 2810 mm</p> <p>Outer casing for flush installation h 76 mm</p> <p>WCBR21A - 567 mm WCBR22A - 847 mm WCBR23A - 1127 mm WCBR25A - 1689 mm WCBR27A - 2250 mm WCBR29A - 2810 mm</p> <p>Outer casing for deep-set installation – black h 91 mm</p> <p>WCBR290PF - flush installation WCBR290PA - deep-set installation</p> <p>Horizontal L-shaped outer casing 588x648 mm</p> <p>WCBR290SF - flush installation WCBR290SA - deep-set installation</p> <p>Vertical L-shaped outer casing 634x634 mm</p>	<p>CODE DALI 54W/m BR2 ■ 111 ■ 0BD</p> <p>ON/OFF BR2 ■ 1 ■ 1 ■ 0B0</p> <hr/> <p>LENGTH 1 - 562 mm 2 - 842 mm 3 - 1122 mm 5 - 1682 mm 7 - 2242 mm 9 - 2802 mm</p> <p>POWER 0 - 27W/m 1 - 54W/m</p> <p>LED COLOUR F - 2700K 5 - 3000K 9 - 4000K</p>	<p>WRBR21D - 563 mm WRBR22D - 843 mm WRBR23D - 1123 mm WRBR25D - 1685 mm WRBR27D - 2246 mm WRBR29D - 2806 mm</p> <p>Diffuse optics</p> <p>WRBR21P - 563 mm WRBR22P - 843 mm WRBR23P - 1123 mm WRBR25P - 1685 mm WRBR27P - 2246 mm WRBR29P - 2806 mm</p> <p>Microprismatic optics</p>	<p>WHBR2000 Honeycomb louvre 562 mm version: 4 pieces honeycomb louvre 842 mm version: 6 pieces honeycomb louvre 1122 mm version: 8 pieces honeycomb louvre 1682 mm version: 12 pieces honeycomb louvre 2242 mm version: 16 pieces honeycomb louvre 2802 mm version: 20 pieces honeycomb louvre</p> <p>The honeycomb louvre can be fitted on diffuse optics and with outer casing for deep-set installation</p> <p>WABR201A Alignment kit for outer casings</p> <p>WF0321 Five-pin female connector</p> <p>WUBR2000 Casing filler kit</p> <p>WNBR001A Anti-fall kit for outer casings: WCBR25F, WCBR25A WCBR27F, WCBR27A WCBR29F, WCBR29A</p> <p>for spare parts, see p. 866</p>

BRENTA CUSTOM

ASSEMBLE BRENTA IN THE LENGTH YOU WANT

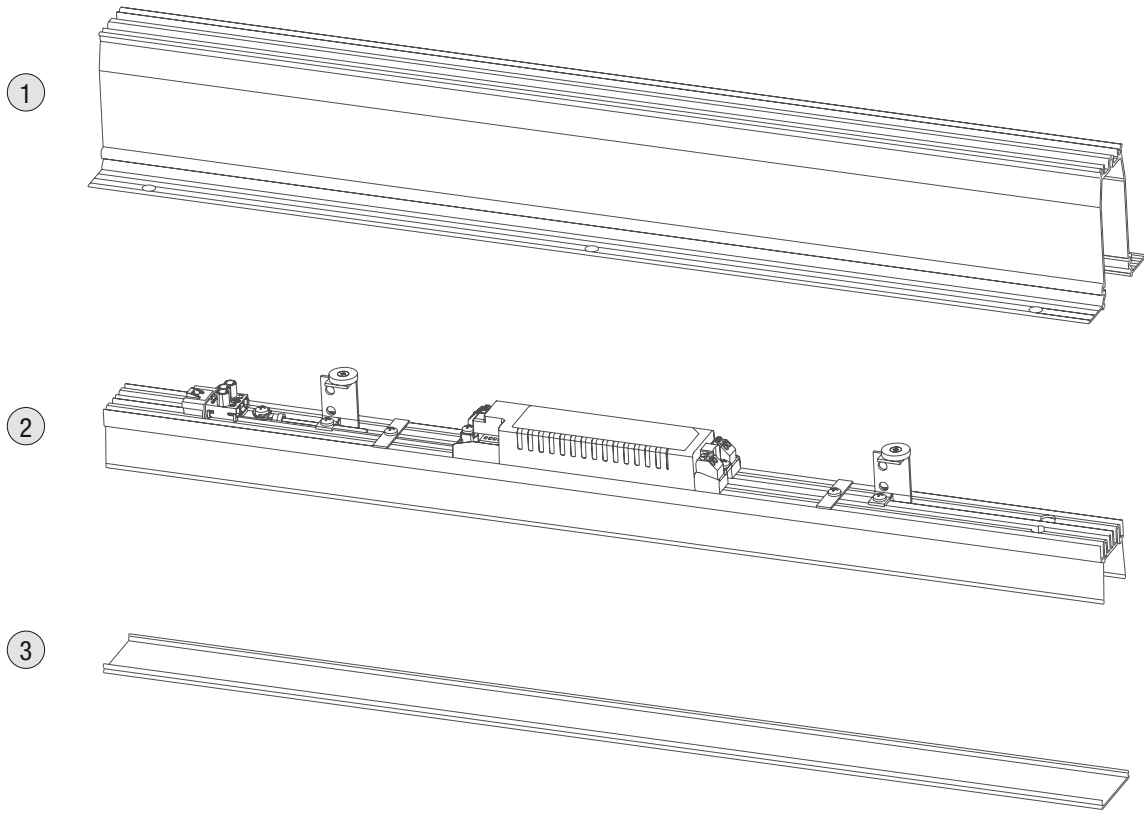

4  ACCESSORIES

▼
BRENTA 1
3000K, 19W/m, diffuse optics
installation flush with ceiling



642

L&L Luce&Light

1 OUTER CASING	BRENTA 1	BRENTA 2
Outer casing for flush installation see the standard outer casings on p. 639 and 641 to achieve the desired length, if necessary	WCBR17FC 2247 mm WCBR19FC 2807 mm h 80 mm	WCBR27FC 2247 mm WCBR29FC 2807 mm h 76 mm
Outer casing for deep-set installation – black see the standard outer casings on p. 639 and 641 to achieve the desired length, if necessary	WCBR17AC 2247 mm WCBR19AC 2807 mm h 95 mm	WCBR27AC 2247 mm WCBR29AC 2807 mm h 91 mm
Required outer casing, not included		

2 LIGHTING FIXTURE	BRENTA 1	BRENTA 2
	<p>CODE DALI 27W/m BR1 ■ 111 ■ 0BD ON/OFF BR1 ■ 1 ■ 1 ■ 0B0</p> <hr/> <p>■ LENGTH 1 - 562 mm 2 - 842 mm 3 - 1122 mm 5 - 1682 mm 7 - 2242 mm 9 - 2802 mm</p> <p>■ POWER 0 - 19W/m 1 - 27W/m</p> <p>■ LED COLOUR F - 2700K 5 - 3000K 9 - 4000K</p>	<p>CODE DALI 54W/m BR2 ■ 111 ■ 0BD ON/OFF BR2 ■ 1 ■ 1 ■ 0B0</p> <hr/> <p>■ LENGTH 1 - 562 mm 2 - 842 mm 3 - 1122 mm 5 - 1682 mm 7 - 2242 mm 9 - 2802 mm</p> <p>■ POWER 0 - 27W/m 1 - 54W/m</p> <p>■ LED COLOUR F - 2700K 5 - 3000K 9 - 4000K</p>

3 SCREEN	BRENTA 1	BRENTA 2
Diffuse optics	WRBR105D 5000 mm WRBR110D 10000 mm WRBR115D 15000 mm	WRBR205D 5000 mm WRBR210D 10000 mm WRBR215D 15000 mm
Microprismatic optics	WRBR105P 5000 mm WRBR110P 10000 mm WRBR115P 15000 mm	WRBR205P 5000 mm WRBR210P 10000 mm WRBR215P 15000 mm
Required screen, not included		

BRENTA CUSTOM

ASSEMBLE BRENTA IN THE LENGTH YOU WANT

4 ACCESSORIES

ACCESSORIES FOR INSTALLATION WITH CORNER



Horizontal L-shaped outer casing



Vertical L-shaped outer casing

BRENTA 1

WCBR190PF
Flush installation
WCBR190PA
Deep-set installation
588x620 mm

WCBR190SF
Flush installation
WCBR190SA
Deep-set installation
644x644 mm

BRENTA 2

WCBR290PF
Flush installation
WCBR290PA
Deep-set installation
588x648 mm

WCBR290SF
Flush installation
WCBR290SA
Deep-set installation
634x634 mm

ACCESSORIES FOR INSTALLATION

Alignment kit for outer casings

WABR101A

WABR201A

Connectors

WF0320
Three-pin female connector
WF0321
Five-pin female connector

WF0320
Three-pin female connector
WF0321
Five-pin female connector

Pair of end caps for outer casings

WABR100F
Flush installation
WABR100A
Deep-set installation

WABR200F
Flush installation
WABR200A
Deep-set installation

Pair of extractors for outer casings

WNB000A

WNB000A

Casing filler kit

WUBR1000

WUBR2000

Anti-fall kit

WNB001A
for outer casing:
WCBR15F, WCBR15A
WCBR17F, WCBR17A
WCBR19F, WCBR19A
WCBR17FC, WCBR17AC
WCBR19FC, WCBR19AC

WNB001A
for outer casing:
WCBR25F, WCBR25A
WCBR27F, WCBR27A
WCBR29F, WCBR29A
WCBR27FC, WCBR27AC
WCBR29FC, WCBR29AC

ANTI-GLARE ACCESSORIES

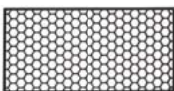

Honeycomb louvre

the honeycomb louvre can be fitted on diffuse optics and with outer casing for deep-set installation

WHBR1000
length: 140 mm

WHBR2000
length: 140 mm

EXAMPLE OF BRENTA CUSTOM 1 CONFIGURATION

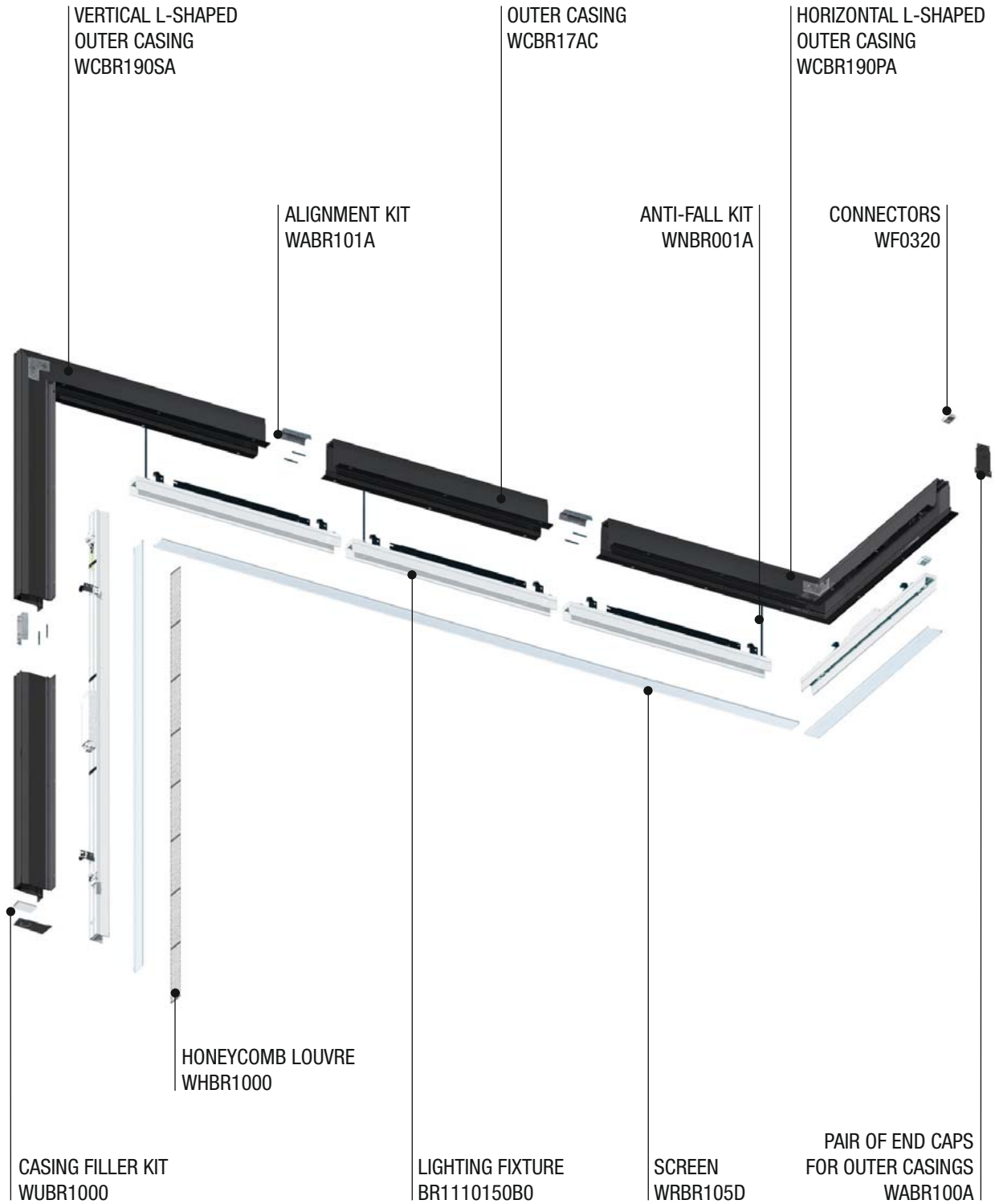

BRENTA

INDOOR LINEAR PROFILES

BRENTA 1

Diffuse
flush installation - 562 mm

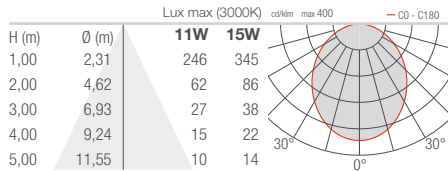

Microprismatic
flush installation - 562 mm

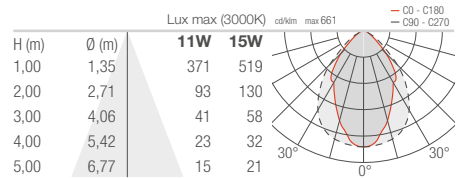

Diffuse
deep-set installation - 562 mm

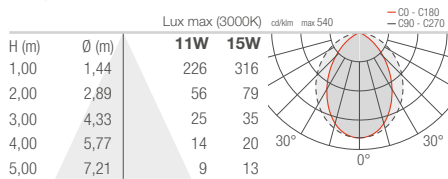

Microprismatic
deep-set installation - 562 mm

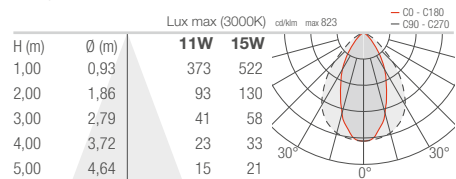

BRENTA 2

Diffuse
flush installation - 562 mm

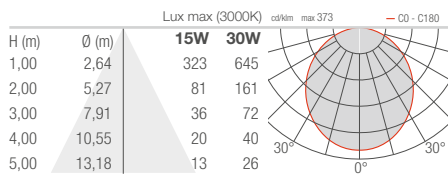

Microprismatic
flush installation - 562 mm

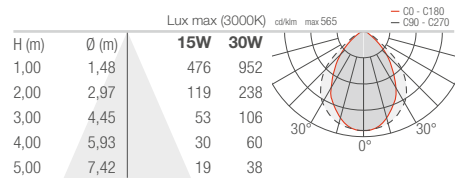

Diffuse
deep-set installation - 562 mm

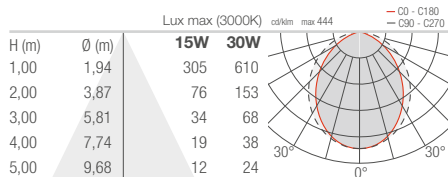

Microprismatic
deep-set installation - 562 mm

