



**TLR04M-350-700**

Power supply units and control gears  
Alimentatori ed elettronica di controllo



**Technical specs:**

**TLR04M-350-700**

Power supply: 12/24/36 Vdc  
 Output: 3 channels, 350/700 mA  
 Output: max 3 LED/ch @12Vdc  
 max 6 LED/ch @24Vdc  
 max 9 LED/ch @36Vdc  
 Code: rolling code  
 Dimensions: L174×W46×H35 (mm)  
 Radio frequency: 433.92 MHz  
 Range: 100m (40m inside buildings)  
 Ta: -20°C - +55°C

**Dati tecnici:**

**TLR04M-350-700**

Alimentazione: 12/24/36 Vdc  
 Uscita: 3 canali, 350/700 mA  
 Uscita: max 3 LED/canale @12Vdc  
 max 6 LED/canale @24Vdc  
 max 9 LED/canale @36Vdc  
 Codifica: rolling code  
 Dimensioni: L174×W46×H35 (mm)  
 Frequenza radio: 433.92 MHz  
 Portata: 100m (40m in interno)  
 Ta: -20°C - +55°C

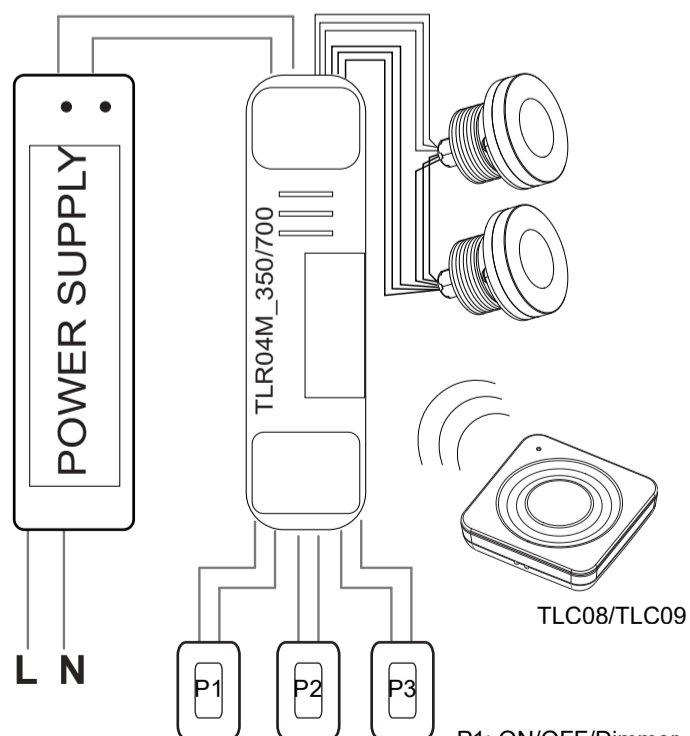
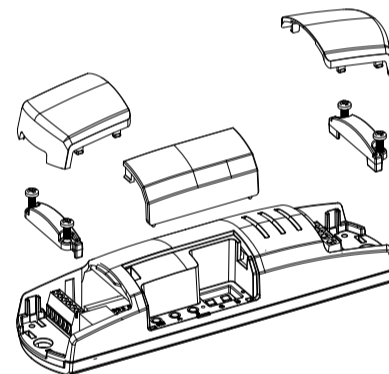
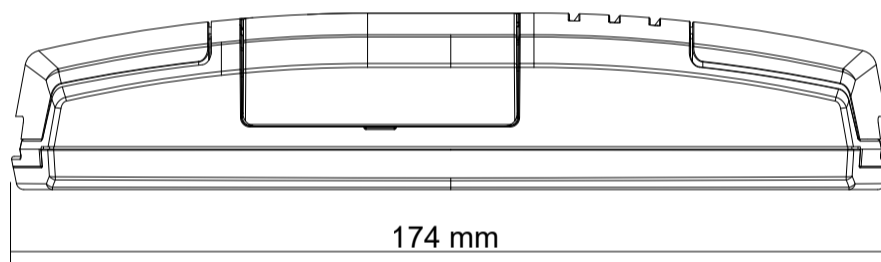
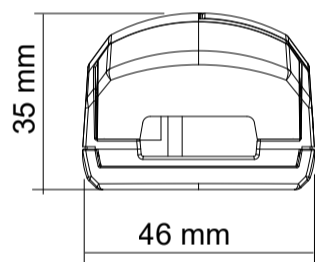

P1: ON/OFF/Dimmer  
 P2: Cambio colore da palette; colour change from palette  
 P3: Start/stop ciclo, set up velocità; start/stop cycle, speeds set-up

