

L u c e & L i g h t

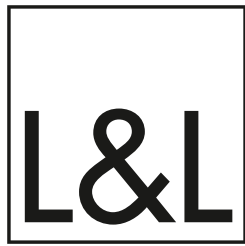

L u c e & L i g h t



LIGHT UP YOUR PROJECTS

LIGHTING UP ARCHITECTURE

SINCE 2007

Designing and producing LED lighting systems has been our speciality since 2007.

We are proud to be an authentic example of the Made in Italy branding, with a flair for innovation and a profound appreciation of architectural design. Our lighting fixtures integrate perfectly with both indoor and outdoor spaces and surfaces to recreate a natural architectural illumination.

OUTDOOR RECESSED

QUILATERO

3.5-22W
110-230Vac / 230Vac
white light
wide range of optics
drive-over

p. 63



1.0 / 1.1
fixed optics

p. 64



2.0 / 2.1
fixed optics

p. 65



2.4 / 2.5
tiltable optics

p. 66



3.0 / 3.1
fixed optics
zoom lens

p. 67



3.4 / 3.5
tiltable optics

p. 68



4.0 / 4.1
fixed optics
zoom lens

p. 69



4.4 / 4.5
tiltable optics

ALTOPIANO

8-20W
110-230Vac
white light

p. 74



1.0
fixed optics

p. 74



1.1
fixed optics

p. 75



2.0
fixed optics

p. 75



2.1
fixed optics

p. 76



3.0
fixed optics

p. 77



3.1
fixed optics

SMOOTHY

2-13W
700mA / 24Vdc
white / RGB light
wide range of optics
drive-over / walk-over

p. 83



1.0 / 1.6
fixed optics

p. 84



2.4
fixed optics
RGB

p. 85



2.8
tiltable optics

p. 86



5.4
fixed optics

p. 87



5.6
tiltable optics
RGB

BRIGHT

0.5-20W
500mA / 12Vac /
12Vdc / 24Vdc
white / blue / RGB /
RGBW light
wide range of optics
drive-over / walk-over

p. 93



MINI 1.0
fixed optics

p. 93

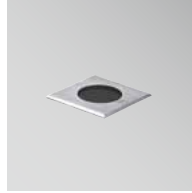

MINI 1.1
fixed optics

p. 94 / 95 / 97



1.0 / 1.2 / 1.6
fixed optics
RGB

p. 95 / 97

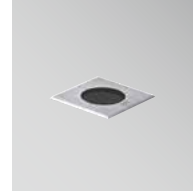

1.1 / 1.7
fixed optics
RGB

p. 98 / 101



2.4 / 2.8
fixed / tiltable optics
RGB

p. 99 / 101

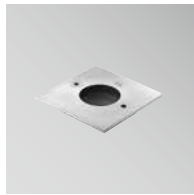

2.5 / 2.9
fixed / tiltable optics
RGB

p. 102 / 103



3.F / 3.G
fixed / tiltable optics

p. 103



3.H
fixed optics
RGBW

p. 104 / 105



5.F / 5.G
fixed / tiltable optics

p. 105



5.H
fixed optics
RGBW

LITUS

2-13W
700mA / 24Vdc
white / RGB light
wide range of optics
drive-over

p. 112 / 113



1.0 / 1.6
fixed optics

p. 112 / 113

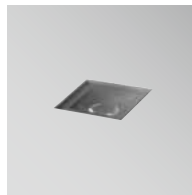

1.1 / 1.7
fixed optics

p. 114



2.4
fixed optics
RGB

p. 115



2.5
fixed optics
RGB

p. 116



2.8
tiltable optics

p. 116

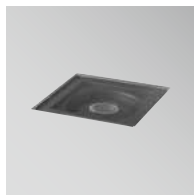

2.9
tiltable optics

p. 117



5.4
fixed optics

p. 117

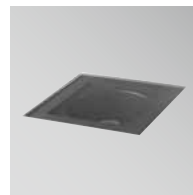

5.5
fixed optics

p. 120



5.6
tiltable optics
RGB

p. 121



5.7
tiltable optics
RGB

CORSO

3.5-21W
110-230Vac / 230Vac
white light
drive-over

p. 128



1.0
fixed optics

p. 128



2.0
fixed optics

p. 129



3.0
fixed optics

p. 129



4.0
fixed optics

OUTDOOR RECESSED

STRA

25-39W
230Vac / 24Vdc
white / RGBW light
drive-over

p. 136



1.0
fixed optics

p. 136 / 137



2.0 / 4.0
adjustable optics

p. 137



3.0
two-way adjustability

p. 138



5.0
fixed optics
RGBW

BEAM

3W
350mA / 700mA
white / RGB light
walk-over

p. 141



1.0
fixed optics
RGB

OUTDOOR LINEAR PROFILES

COLORADO

41-85W
230Vac
white / RGBW light
drive-over

p. 152 / 153



1.0 / 1.1 / 1.2

p. 154 / 155



2.0 / 2.1 / 2.2

p. 156 / 157



3.0 / 3.1 / 3.2

p. 158 / 159



4.0 / 4.1 / 4.2
RGBW

p. 160 / 161



5.0 / 5.1 / 5.2
RGBW

p. 162 / 163



6.0 / 6.1 / 6.2
RGBW

TAGO

14-55W
230Vac / 48Vdc
white / RGBW light
drive-over

p. 170 / 171



1.0 / 1.1 / 1.3

p. 172 / 173

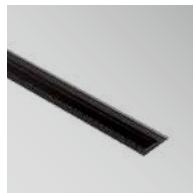

2.0 / 2.1 / 2.3

p. 174 / 175



3.0 / 3.1 / 3.3

p. 176 / 177

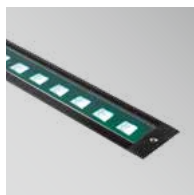

4.0 / 4.1 / 4.3
RGBW

p. 178 / 179

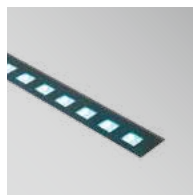

5.0 / 5.1 / 5.3
RGBW

p. 180 / 181



6.0 / 6.1 / 6.3
RGBW

OUTDOOR LINEAR PROFILES

NEVA

5.5-75W
230Vac / 24Vdc
white / RGB / RGBW /
dynamic white light
recessed or surface
installation
walk-over

p. 188 / 189

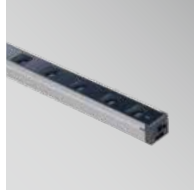

MINI 1
1.0 / 1.1 / 1.2
60 mm pitch
white light

p. 190 / 191



MINI 2
2.0 / 2.1 / 2.2
120 mm pitch
white light

p. 194 / 195



3.0 / 3.1 / 3.2
60 mm pitch
white light

p. 196 / 197

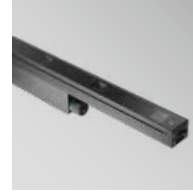

4.0 / 4.1 / 4.2
120 mm pitch
white light

p. 198 / 199



MINI 5
5.0 / 5.1 / 5.2
120 mm pitch
RGB

p. 200 / 201



MINI 6
6.0 / 6.1 / 6.2
120 mm pitch
dynamic white

p. 202 / 203

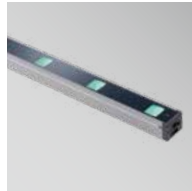

MINI 7
7.0 / 7.1 / 7.2
120 mm pitch
RGBW

RIO

3-38W
24Vdc
white / RGB light
drive-over

p. 211 / 212 / 213



1.0 / 1.1 / 1.2 / 1.3 / 1.4

p. 215 / 216 / 217



2.0 / 2.1 / 2.2 / 2.3 / 2.4



OUTDOOR PROJECTORS

GINKO

2.5-25W
500mA / 24Vdc
white / RGB light
wide range of optics

p. 229



1.0
fixed focus

p. 229



1.4
zoom lens

p. 230



2.0
fixed focus

p. 231



2.2
fixed focus
RGB

p. 231



2.4
zoom lens

p. 234



3.0
fixed focus

p. 235



3.4
zoom lens

p. 237



4.0
fixed focus

PIVOT

2.5-14W
500mA / 24Vdc
white / RGB light

p. 245

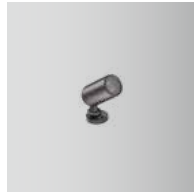

MINI 1
fixed focus

p. 246



1.7
fixed focus

p. 247

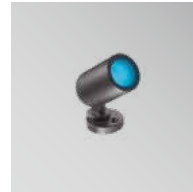

1.8
fixed focus
RGB

p. 249



2.0
fixed focus
zoom lens

DUOMO

10-56W
230Vac
white light
wide range of optics

p. 256



1.0

p. 256



2.0

p. 257



3.0

p. 257



4.0

OUTDOOR PROJECTORS

SIRI

9-33W
230Vac / 24Vdc
white / RGBW light

p. 264 / 265

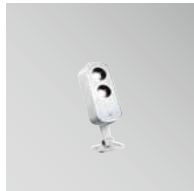

1.0 / 1.2

p. 264 / 265



1.1 / 1.3

p. 266 / 267

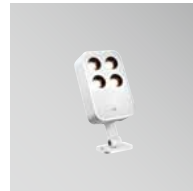

2.0 / 2.2

p. 266 / 267



2.1 / 2.3

p. 268 / 269



3.0 / 3.2

p. 268 / 269



3.1 / 3.3

SPOT

2-32W
500mA / 24Vdc /
230Vac
white / blue light

p. 275



1.0 / 1.6

p. 276



2.4

p. 277



3.4

p. 279



4.4

FLORI

7-13W
230Vac / 24Vdc
white / RGBW light

p. 284



1.0

p. 284



1.1

p. 285



1.2
RGBW

p. 285



1.3
RGBW

STRA P

37-39W
230Vac / 24Vdc
white / RGBW light

p. 291

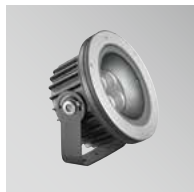

1.0

p. 292



5.0
RGBW



LYSS

3-19W
230Vac / 24Vdc
white / blue / RGBW light

p. 298

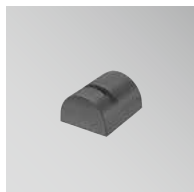

MINI 1.0

p. 299



1.0

p. 299



2.0
RGBW

AKRO

37-43W
230Vac / 1050mA
white light
zoom lens

p. 308



1.0

p. 309



1.1

p. 309

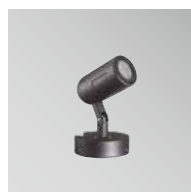

1.2

OUTDOOR WALL MOUNTED

BERICA OUT

15-56W
230Vac
white light
double beam

p. 318



1.0

p. 319



1.1

p. 319



1.2

p. 320



2.0

p. 321



2.1

p. 321



2.2

p. 322



3.0

p. 323



3.1

p. 323



3.2

INTONO

3-38W
230Vac / 24Vdc
white light
wide range of optics

p. 329



1.1 / 1.2
single / double beam

p. 331



2.1 / 2.2
single / double beam

p. 332 / 333



3.1 / 3.2 / 3.9
single / double beam
with speaker

p. 334 / 335



4.1 / 4.2 / 4.9
single / double beam
with speaker

GEKO

10-28W
230Vac
white light

p. 338 / 339



5.0 / 6.0
single / double beam
diffuse

p. 338 / 339



5.1 / 6.1
single / double beam
with optics

KOCCA

4-40W
230Vac
white light

p. 344



1.1 / 1.2
single / double beam

p. 345



1.3 / 1.4
3/4 beams

p. 346 / 347



3.1 / 3.2
single / double beam

p. 347



3.4
4 beams

ELLA OUT

7-19W
230Vac
white diffuse light
single beam

p. 352



1.0

p. 353



2.0

p. 353



3.0

UPDOWN

4-8W
500mA / 24Vdc
white / blue / RGB light

p. 358



3.0 / 3.6
single beam
RGB

p. 359



4.0 / 4.6
double beam
RGB

p. 360



6.0
double beam

p. 371



7.0
2/3/4 beams

BROM

2-12W
500mA
white / blue light

p. 366 / 367



1.0 / 3.0
single beam

p. 366 / 367



2.0 / 4.0
double beam

CUBE W

3-6W
350mA / 500mA
white / blue / RGB light
single beam

p. 369



1.0 / 1.1

OUTDOOR CEILING MOUNTED

INTONO C OUT

9-20W
230Vac / 24Vdc
white light

p. 376



2.4

p. 377



3.4

p. 377



3.9
with speaker

ELLO OUT

7-19W
230Vac
white diffuse light

p. 382



1.0

p. 383



2.0

p. 383



3.0

CUBE C

3-6W
350mA / 500mA
white / blue / RGB light

p. 387



1.2 / 1.3

TAK

10-18W
230Vac
white light

p. 389



1.0
diffuse

p. 389



1.1
with optics

OUTDOOR STEP LIGHTS

RONDÒ

2-8W
230Vac / 24Vdc
white light
drive-over

p. 398

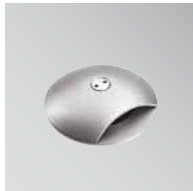

1.1
single beam

p. 399



1.2
double beam

p. 399



2.1
single beam

p. 402



3.1
single beam

p. 403



3.2
double beam

p. 403



3.4
4 beams

BEAM

2W
350mA / 500mA /
24Vdc
white / blue light
walk-over

p. 408 / 409

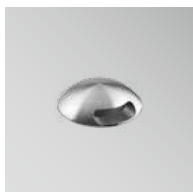

2.0 / 2.6
single / double beam

p. 408 / 409



2.1 / 2.7
single / double beam

BRIGHT

2-4W
700mA / 24Vdc
white / blue light
drive-over / walk-over

p. 415



1.A / 1.B

p. 417



4.7

p. 417



9.7

OUTDOOR STEP LIGHTS

PASITO

5-13W
230Vac / 24Vdc
white light

p. 424



MINI 1.0
flush recessed

p. 425



MINI 1.1
recessed installation,
with frame

p. 425



MINI 1.2
surface mounted

p. 426



1.0
flush recessed

p. 427



1.1
recessed installation,
with frame

p. 427



1.2
surface mounted

STEP OUTSIDE

2-3.5W
500mA / 24Vdc
white / blue light

p. 432 / 433



2.0 / 2.6
semi-recessed

p. 432 / 433



2.1 / 2.7
semi-recessed

p. 435



5.1
recessed

p. 435



5.2
recessed

p. 436



6.1
recessed

p. 437

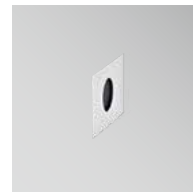

6.2
recessed

p. 437



6.3
recessed

p. 439



7.0
surface mounted

p. 439



8.0
surface mounted

LIRA

6-12W
230Vac
white light

p. 445



1.0

p. 445



2.0

ICE LED

1W
350mA
white / blue light

p. 449



1.0

p. 449



1.1

OUTDOOR BOLLARDS

PLIN

8-24W
230Vac
white light

p. 458



1.0
single beam

p. 459



1.1
single beam

p. 459



1.2
single beam

p. 460



2.0
single beam

p. 461



2.1
single beam

p. 461



2.2
single beam

p. 462



3.0
double beam

p. 463



3.1
double beam

p. 463



3.2
double beam

p. 464



4.0
single beam

p. 465



4.1
single beam

p. 465



4.2
single beam

p. 466



5.0
single beam

p. 467



5.1
single beam

p. 467



5.2
single beam

p. 468



6.0
asymmetric circular

p. 469



6.1
asymmetric circular

p. 469



6.2
asymmetric circular



LINEAR

4-32W
230Vac
white light

p. 474 / 475



2.1 / 2.2 / 2.3 / 2.4
1/2/3/4 beams

p. 478 / 479



4.1 / 4.2 / 4.4
1/2/4 beams

BITTA

10-20W
230Vac
white light

p. 485



1.0 / 1.1
single / double beam



URBAN LIGHTING

SIRI BLVD

38W
230Vac
white light

p. 490



1.0
pole mounted

p. 491



2.0
pole mounted

p. 491



3.0
wall mounted

INDOOR RECESSED

COMBINA D

6-29W
300mA / 400mA /
500mA / 800mA / 230Vac
white light
installation flush with
ceiling / rebated

p. 504



1.0 / 1.1
round/square
fixed/tiltable

p. 506



2.0 / 2.1
round/square
fixed/tiltable

p. 508



3.0 / 3.1
round/square
fixed/tiltable

p. 510



4.0 / 4.1
round/square
fixed/tiltable

p. 512 / 513



KIT COMBINA D 1.0 / 2.0
round/square
fixed

TURIS

4.5-22W
230Vac / 24Vdc
white diffuse light

p. 517



MINI 1.0

p. 517



MINI 1.1

p. 518



1.0

p. 518



1.1

p. 519

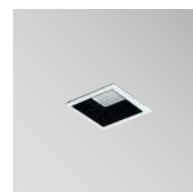

1.2

p. 519



1.3

p. 523 / 526



2.0 / 4.0
deep-set installation

p. 524



3.0

p. 524



3.1

p. 525



3.2

p. 525



3.3

p. 527



5.0

p. 527



5.1

BITPOP

6.5-50W
230Vac / 24Vdc
white light
deep-set / rebated
installation

p. 532

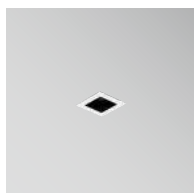

1.0

p. 533



2.1

p. 533

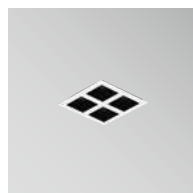

2.2

p. 534



4.1

p. 535

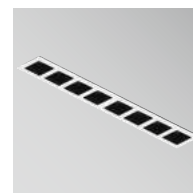

8.1

CIAK

1.5-5W
500mA / 24Vdc
white light

p. 542 / 543 / 545



1.0 / 1.6 / 2.6

p. 542 / 543 / 545



1.1 / 1.7 / 2.7

CAMEO

1.5-5W
500mA / 24Vdc
white light

p. 548 / 550 / 552



1.0 / 1.6 / 2.6
fixed optics and
fixed focus

p. 549 / 551 / 553



1.1 / 1.7 / 2.7
tiltable optics and
fixed focus

p. 549 / 551 / 553



1.2 / 1.8 / 2.8
tiltable
zoom lens

ESEM

2-14W
350mA / 500mA /
24Vdc / 230Vac
white light

p. 556 / 557



MINI 1.0 / MINI 1.6
fixed optics

p. 556 / 557



MINI 1.1 / MINI 1.7
tiltable optics

p. 558 / 559



MID 1.0 / MID 1.6
fixed optics

p. 558 / 559



MID 1.1 / MID 1.7
tiltable optics

p. 561



2.0 / 2.6
fixed optics

p. 562



3.0
fixed optics

p. 563



3.1
tiltable optics

p. 563



3.2
tiltable optics

p. 564



4.0
fixed optics

p. 565



4.1
tiltable optics

p. 565



4.2
tiltable optics

INDOOR RECESSED

EYES

1-3W
350mA / 700mA / 24Vdc
white / blue light

p. 568 / 569



1.0 / 1.6

p. 568 / 569



1.2 / 1.8

p. 570 / 571



2.R / 2.T

p. 570 / 571

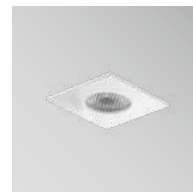

2.S / 2.U

QUAD

6-18W
500mA
white / blue / RGB light
deep-set installation

p. 576



6.1

p. 577



6.2

p. 577



6.3

LED OPTICAL FIBRES

3W
350mA / 700mA
white / blue / RGB light

p. 581





INDOOR PROJECTORS

KRILL

1-4.5W
350mA / 700mA
white light
wide range of
installation accessories

p. 592



1.0
fixed focus

p. 592



1.4
zoom lens

p. 593



2.0
fixed focus

p. 593



2.4
zoom lens

p. 595



3.0
fixed focus

p. 595



3.4
zoom lens

GEM

1-4.5W
350mA / 700mA
white light

p. 600

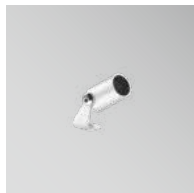

MINI 1

p. 601

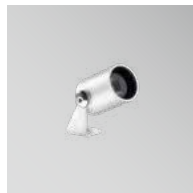

1.1

p. 601



2.1

INDOOR WALL MOUNTED

BERICA IN

8-54W
230Vac
white light
double beam

p. 612



1.0

p. 613

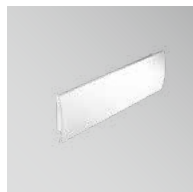

1.1

p. 613



1.2

p. 614

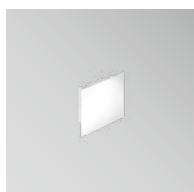

2.0

p. 615

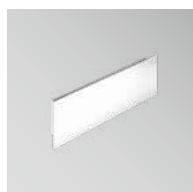

2.1

p. 615



2.2

p. 616

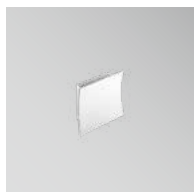

3.0

p. 617



3.1

p. 617



3.2

ELLA IN

7-19W
230Vac
white diffuse light
single beam

p. 624



1.0

p. 625



2.0

p. 625



3.0

VERSA

9-18W
230Vac
white diffuse light

p. 629



1.0
single beam

p. 629



2.0
double beam



READING LAMPS

WALL

2-3.5W
230Vac / 500mA
white light

p. 634



1
zoom lens

p. 635



3
zoom lens

p. 636



8.0
fixed focus

p. 637

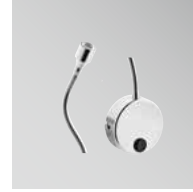

8.1
fixed focus

p. 637



8.2
fixed focus

INDOOR CEILING MOUNTED

INTONO C IN

9-20W
24Vdc / 230Vac
white light

p. 646



2.3

p. 647



3.3

p. 647



3.8
with speaker

BITPOP C

6.5-18W
230Vac / 24Vdc
white light

p. 652



1.0

p. 653



2.2

p. 653



4.1

TEKO

5-17W
230Vac
white diffuse light

p. 656 / 657



5.0 / 7.0

p. 656 / 657



5.1 / 7.1

ELLO IN

7-19W
230Vac
white diffuse light

p. 660



1.0

p. 661



2.0

p. 661



3.0

INDOOR SUSPENDED



BERICA S

14-39W
230Vac
white light
double beam

p. 670



1.0

p. 671



1.1

p. 671



1.2

p. 672



2.0

p. 673



2.1

p. 673



2.2

p. 674



3.0

p. 675



3.1

p. 675



3.2

KORA

3.5-21W
230Vac
white light

p. 678



1.0

p. 679



2.0

p. 679



3.0

INDOOR LINEAR PROFILES

BRENTA

19-54W/m
230Vac
white light
installation flush with
ceiling / deep-set

p. 686



1

p. 688



2

INDOOR STEP LIGHTS

LINE

2W
500mA
white / blue light

p. 700



1.0 / 1.1

p. 701



2.0 / 2.1

STEP INSIDE

2W
500mA / 24Vdc
white / blue light

p. 706 / 707



2.2 / 2.8
semi-recessed

p. 706 / 707



2.3 / 2.9
semi-recessed

SIMPLY

1W
220mA
white / blue diffuse light
walk-over

p. 711



1.0



UNDERWATER RECESSED

MOBY

9-30W
24Vdc
white / RGBW / cyan light

p. 720 / 721 / 725



1.0 / 2.0 / 3.0

p. 720 / 721 / 725



1.1 / 2.1 / 3.1

BRIGHT 316L

2-18W
500mA / 24Vdc
white / blue / RGB light

p. 730 / 731



1.0 316L / 1.6 316L

p. 733



2.0 316L / 2.6 316L
RGB

p. 736

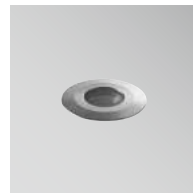

3.0 316L
RGB

p. 737



5.0 316L
RGB



UNDERWATER PROJECTORS

MOBY P

9-30W
24Vdc
white / RGBW / cyan light

p. 746



1.0

p. 746



1.1

p. 747



2.0

p. 747



2.1

p. 749



3.0

p. 749



3.1



UNDERWATER PROJECTORS

SPOT 316L

2-18W
500mA / 24Vdc
white / blue / RGB light

p. 754



1.0 316L / 1.6 316L

p. 755



2.0 316L / 2.6 316L
RGB

p. 757



3.0 316L
RGB



UNDERWATER LINEAR PROFILES

TREVI

7-37W
24Vdc
white / RGB light
surface installation

p. 766 / 767



1.0 / 1.1 / 1.2

RIO SUB

6-19W
24Vdc
white / RGB diffuse light

p. 772



1.1 / 1.2

p. 773



2.1 / 2.2



PHOTOMETRIC DATA

p. 777

PHOTOMETRIC DATA



POWER SUPPLY UNITS AND CONTROL GEAR

p. 904

p. 905

p. 906

p. 910

p. 916

p. 928

TYPES OF
LOW VOLTAGE
CONNECTION

POWER SUPPLY
UNITS AND
CONTROL GEAR

PSU

DIMMABLE
POWER SUPPLY
UNITS

CONTROL
SYSTEMS

EMERGENCY
KIT



ACCESSORIES

p. 932

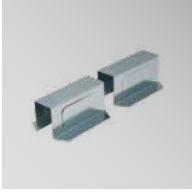

SPARE PARTS

p. 934



WIRING MATERIALS

p. 936



CABLES

LIGHT UP YO

UR PROJECTS

**LANDSCAPE
RESIDENTIAL
ARCHITECTURE
URBAN SITES
HISTORICAL SITES
FOUNTAINS**

LANDSCAPE



National Archaeological Museum gardens
Light planning by / NeaPolis Lighting
Landscape design by / Ecoscapes Landscape Architecture
Photo by / Anastasia Siomou
Athens, Greece

RESIDENTIAL



Private residence
Project by /arch. Mariangela Alicino, Archingegno
Photo by / Alessio Tamborini
Andria, Italy

ARCHITECTURE

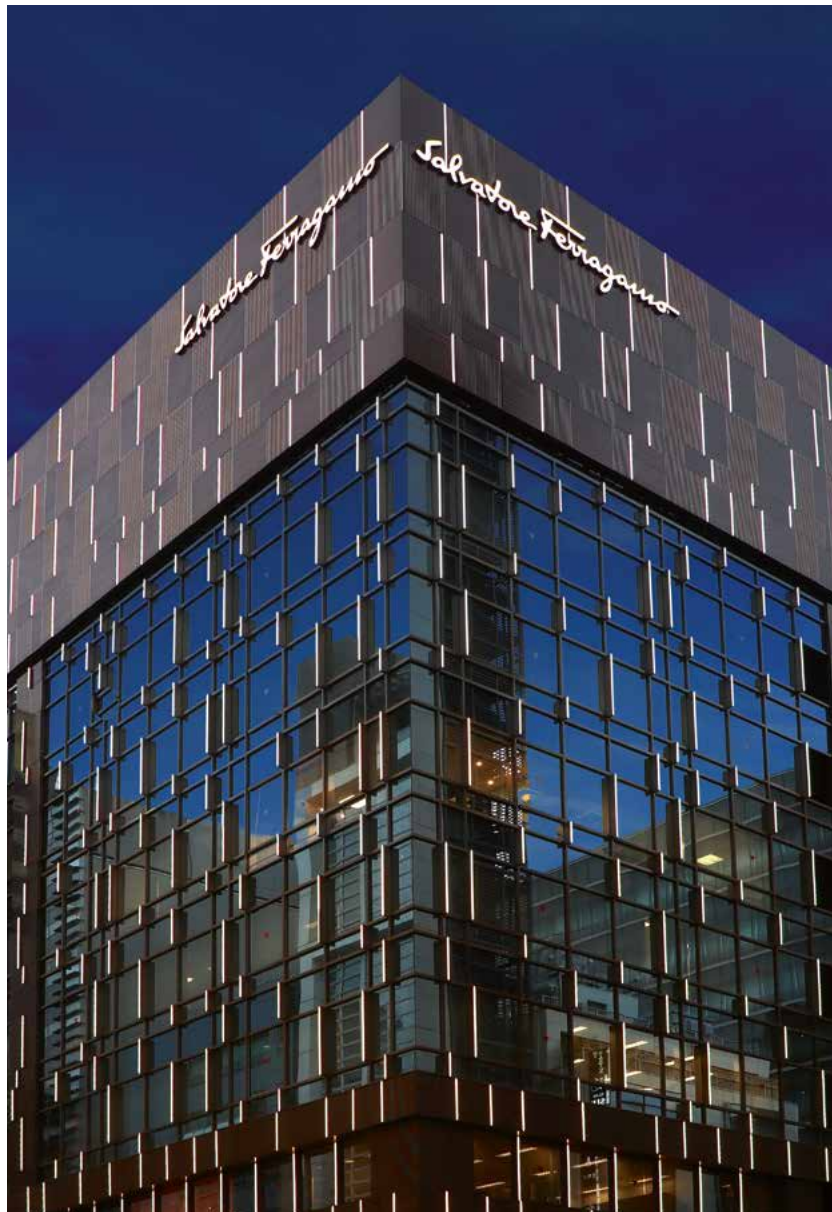

Salvatore Ferragamo Tokyo Ginza Flagship Store
Project by / Salvatore Ferragamo HQ Store planning
Light planning by / Salvatore Ferragamo HQ Store planning
in association with Flux cs Studio
Tokyo, Japan

URBAN SITES

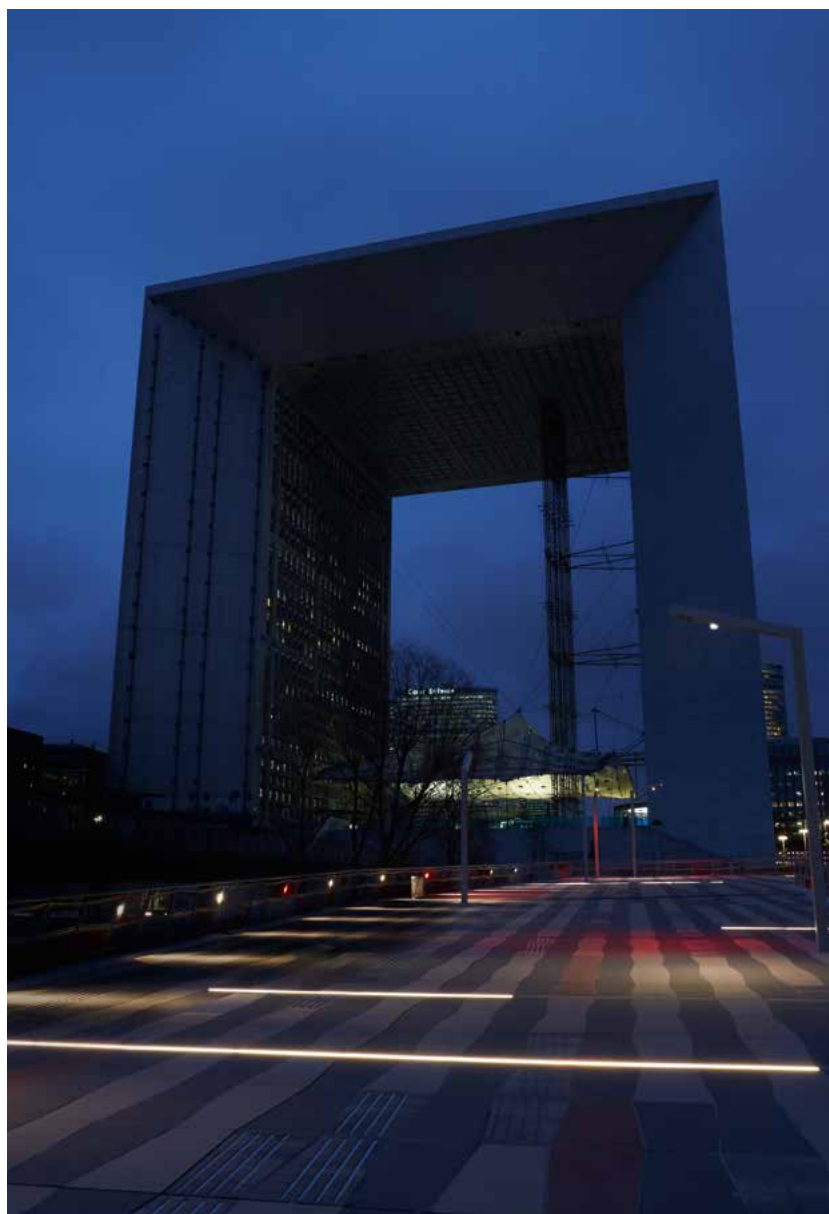

Jardins de l'Arche
Project by / AWP
Light planning by / 8'18"
Paris, France

HISTORICAL SITES

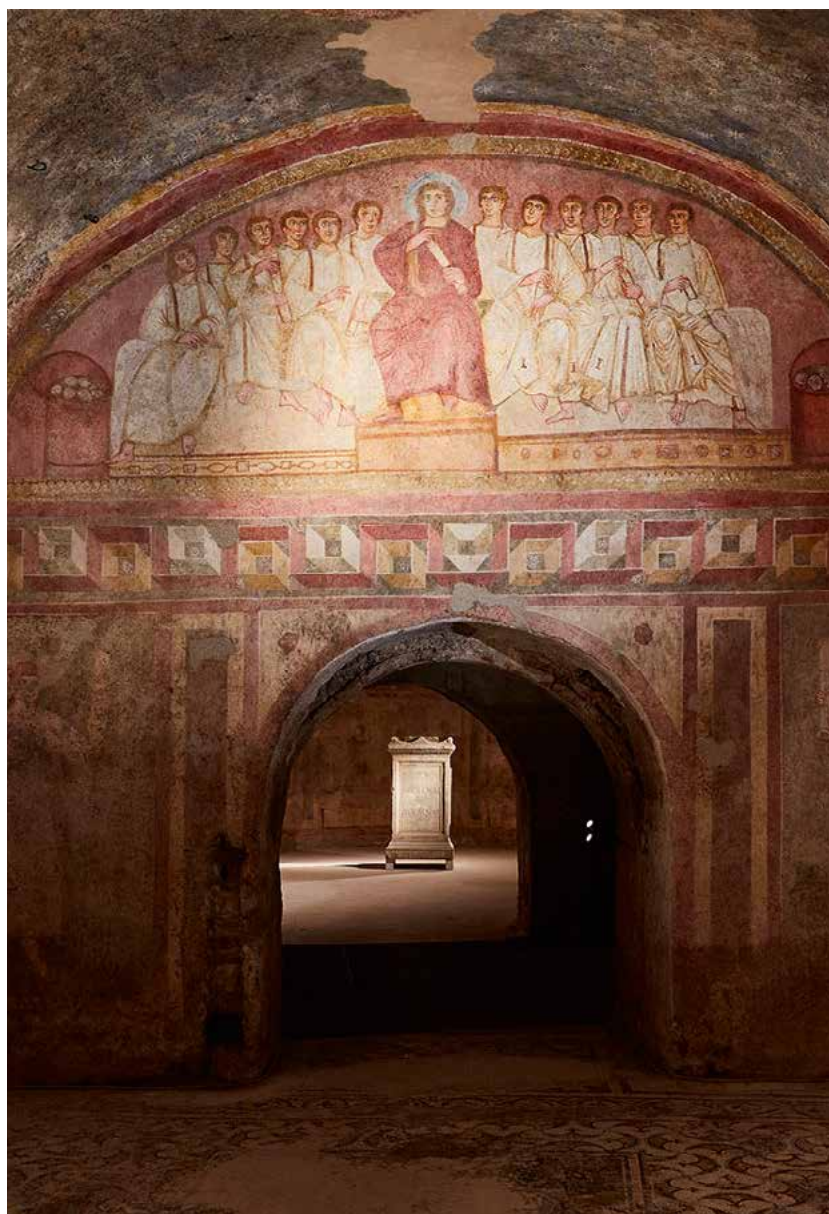

Hypogeum of Santa Maria in Stelle
Light planning by / Lorella Marconi, Cinzia Todeschini
Design by / Lucearchitettura
Historical consultation by / ing. Luigi Antolini
Photo by / Daniele Cortese
Verona, Italy

FOUNTAINS



The maritime station in Genoa
Light planning by / Studio Luce, Gruppo Sacchi
Photo by / Alessio Tamborini
Genoa, Italy



RESPONSIBLE LIGHTING

Our commitment to the environment is reflected in the design of lighting fixtures that combine project and architectural requirements with the principles of responsible lighting, for light that respects natural darkness and protects the circadian cycles of people, animals and plants.



2200K COLOUR TEMPERATURE

to respect the circadian cycles of people and animals by using light outputs with a wide wavelength that is better tolerated



ADJUSTABLE AND ADJUSTED OPTICS

to direct the light output only where it is needed



ANTI-GLARE ACCESSORIES

to limit light spill and increase visual comfort



DIMMING

to control luminous intensity intelligently by dimming it and switching it off when it is not needed for human activities

CONTINUOUS IMPROVEMENT



ISO 9001 CERTIFICATION

L&L Luce&Light is certified to ISO 9001, the international standard that assesses corporate quality management systems.



LIGHTING CONTROL WITH THE CASAMBI APP

The Casambi app can be used to control L&L fixtures using the customized interface. The app automatically recognizes L&L lighting fixtures and lets you control them easily and fully to create and program lighting scenes. Suitable fixtures are identified by the Casambi logo; products that have the option to be controlled with Casambi are indicated in the technical data. The Casambi app is available free of charge on the App Store and Google Play.



CERTIFICATION FOR THE WORLD

CB – programme created by the IECCE for trade in electrical and electronic products
ETL – certification of conformity to product safety standards for the US and Canada
BIS – COMPULSORY REGISTRATION SCHEME – registration scheme required for the Indian market for electrical and electronic products
EAC – Eurasian Conformity mark for the Russian, Belarus, Kazakhstan, Armenian and Kyrgyzstan markets



READY TO GIVE YOU OUR ALL



TECHNICAL SUPPORT

Our customers have access to a complete support and advisory service:

- lighting advice and technical support
- training, with technical meetings aimed at illustrating the features and usage of LED devices.



8-DAY MANUFACTURING LEAD TIME

We will send you an order confirmation in 24 hours, and your order will be ready to ship in 8 working days.



CUSTOMIZED PRODUCTS

All the features of our lighting fixtures – aesthetic, electronic, optical and LED – can be customized.



WARRANTY EXTENSION TO 5 YEARS

Given the high quality of our lighting fixtures, we are happy to extend the warranty against manufacturing or design defects to 5 years.

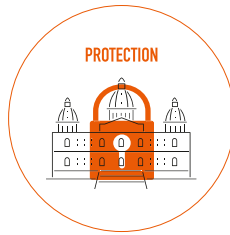

PROJECT PROTECTION

Because we maintain a database in which we record your specifications, we have an overview with which we can help you protect your concept.



LIGHTING UP THE WORLD

Our sales network operates in all five continents.

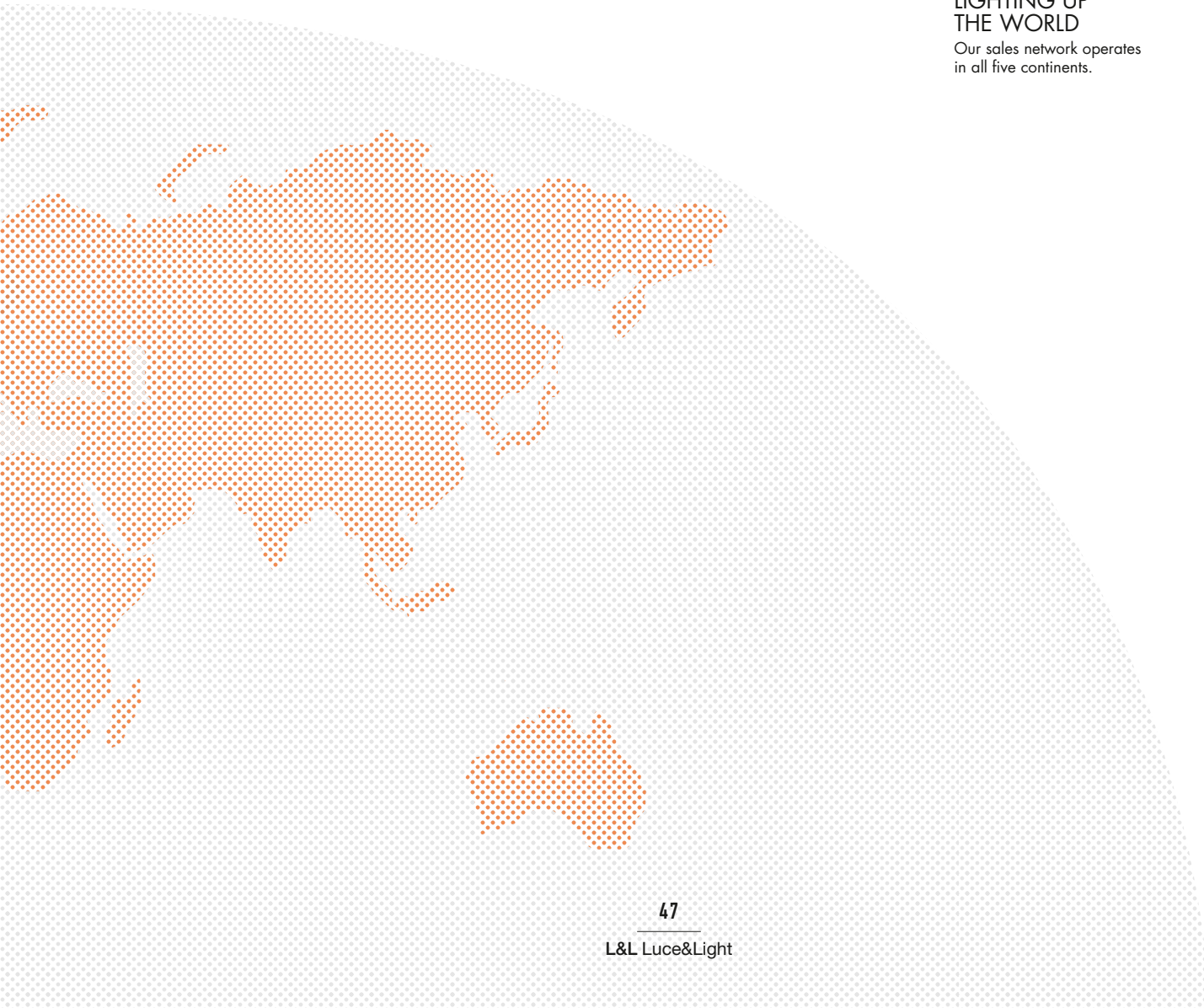



PROTECTION SYSTEMS

R&D TEAM: MORE CUTTING-EDGE BY THE DAY



INTELLIGENT PROTECTION SYSTEM

The IPS protects lighting fixtures from water infiltrations, which can occur if there are faulty junctions between the cables in outdoor or underwater applications. This innovation, patented by L&L, also guarantees electrical protection against polarity reversal, hot plugging, ESD and power surges, which can occur if there are faults in the electrical circuit.



PROTECTIVE IMPEDANCE DEVICE

The PID protects lighting fixtures from electrical phenomena external to the system, such as static electricity accumulation or electromagnetic interference coming from the mains power. Generally, these are events with a low energy content.



ELECTRICAL PROTECTION SYSTEM

This symbol identifies a lighting fixture with EPS, which protects fixtures for indoor applications against electrical problems. This innovation, patented by L&L, guarantees electrical protection against polarity reversal, hot plugging and voltage spikes of up to 48Vdc, which can occur if there are faults in the electrical circuit.



SURGE PROTECTION DEVICE

The SPD protects lighting fixtures from electrical phenomena external to the system, such as power surges. In particular, this device is specifically for protection against serious events with a high energy content.



TEMPERATURE CONTROL BUILT IN

This is an NTC thermistor mounted on the LED board to protect the lighting fixture against overheating. Should the product function at an operating temperature greater than the maximum temperature at which it can operate correctly, the protection is activated and gradually reduces the power.



The protection rating IP69K indicates an electrical device's resistance to cleaning with high-pressure, high-temperature spray-downs. When the fixtures are installed in urban or industrial applications where heavy cleaning is carried out using high-pressure washers, functioning, resistance, service life and appearance are guaranteed even under these conditions. (compliant with ISO 20653)

RELIABILITY

RESISTANCE AND MATERIAL PROTECTION

The materials and technical processes used in the construction of our fixtures protect both functionality and aesthetics, even in severe conditions of continuous exposure to atmospheric and environmental agents.



1. AISI 316L stainless steel or low-copper-content anticorrosional aluminium
2. Surface preparation
3. Paints compliant with Qualicoat automotive coating standard
4. Epoxy paint
5. Polyester paint
6. Salt spray testing

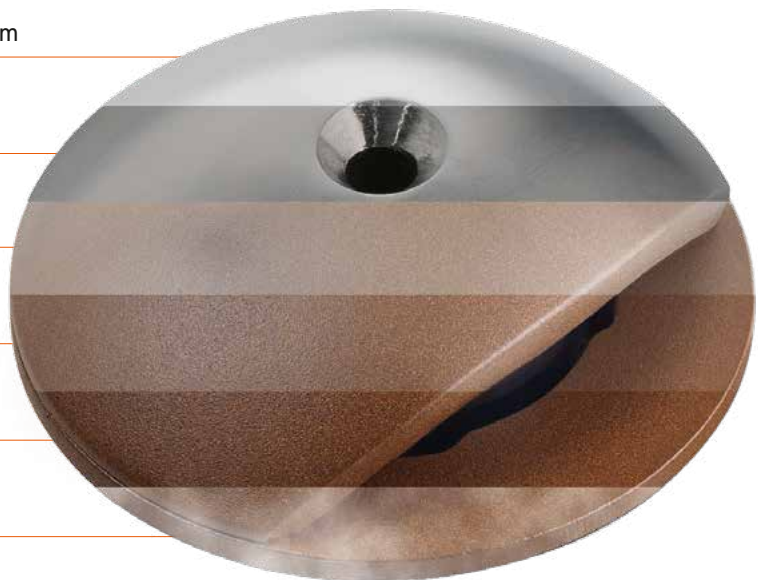

RELIABILITY

WE TEST THE QUALITY OF OUR FIXTURES



CLIMATIC
STRESS
TEST

SALT SPRAY
CHAMBER
TEST

IK TEST
IP TEST

GLOW WIRE
TEST

DRIVE-OVER
TEST

IP69K
CERTIFICATION

Resistance to cleaning
with high-pressure,
high-temperature spray-downs.

OPTICAL
TESTING

Measurement of electrical
and optical parameters
to provide values for the finished
product on a combination of
elements (delivered lumen output,
colour coordinates, colour
temperature, emission spectrum,
CRI and TM-30 analysis.)

E.O.L.
TEST

All L&L lighting devices
are tested and approved
with End-of-Line testing,
including functional testing and
power consumption check.



LUMEN OUTPUT

LUMEN OUTPUT AT SOURCE AND DELIVERED LUMEN OUTPUT

The lumen output at source refers to the junction temperature (T_j) 85°C. The delivered lumen output is measured at the device's operating temperature. The value for the delivered lumen output refers to the optics indicated in brackets. In those cases where other optics noticeably affect the lumen output, multiple values are given. Together with the lumen output, other specifications, such as the power consumption and supply, and the CRI, are provided to further clarify the value given.



Both the at-source and the delivered lumen outputs of devices with RGB, RGBW and dynamic white LED colours are expressed with both the total value and the value for each colour.

THE LUMEN OUTPUT FOR EACH DEVICE IS GIVEN ON THE PRODUCT PAGE BELOW THE CODE AND IS EXPRESSED USING TWO VALUES:

LUMEN OUTPUT AT SOURCE

488 lm (3000K)

LED lumen output with the LED colour temperature in brackets.

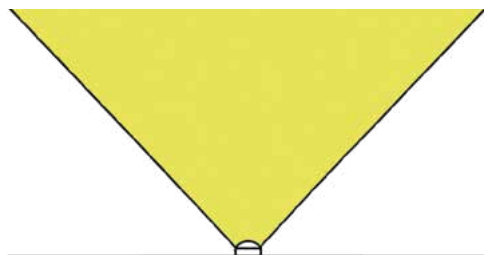

DELIVERED LUMEN OUTPUT

352 lm (3000K, 34°)

The actual lumens delivered by the device with, in brackets, the LED colour temperature and the optics mounted.

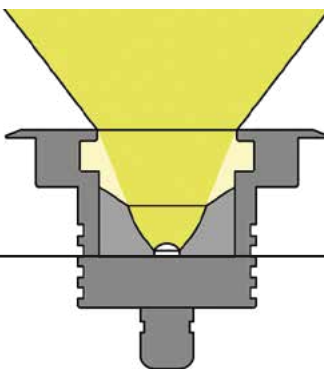

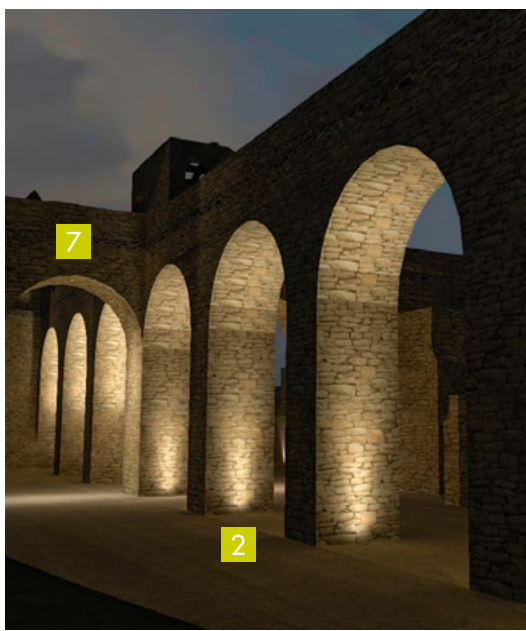

RECESSED FOR OUTDOOR APPLICATIONS

ARCHITECTURAL

QUILATERO p. 58 **1**

SMOOTHY p. 80 **2**

BRIGHT p. 90 **3**

LITUS p. 110 **4**

CORSO p. 124 **5**

STRA p. 132 **6**

AMBIENT LIGHTING













ALTOPIANO p. 72 **7**

ORIENTATION

BEAM p. 140 **8**



ARCHITECTURAL

	MOUNTING	BEAM	LIGHT COLOUR	POWER
QUILATERO see p. 58  MONUMENTAL AREAS	WALL GROUND	OPTICS VERSION fixed / tiltable optics DIFFUSE VERSION fixed optics	 2200K 2700K 3000K 4000K	3.5–22W
SMOOTHY see p. 80  COLUMNS AND ARCHITECTURAL ELEMENTS	CEILING WALL GROUND	DIFFUSE VERSION fixed optics OPTICS VERSION fixed / tiltable optics	 2700K 3000K 4000K RGB	2–13W
BRIGHT see p. 90  COLUMNS AND ARCHITECTURAL ELEMENTS ORIENTATION LIGHTING	CEILING WALL GROUND	DIFFUSE VERSION fixed optics OPTICS VERSION fixed / tiltable optics	 2700K 3000K 4000K 5000K blue green red RGB RGBW	0.5–20W
LITUS see p. 110  COLUMNS AND ARCHITECTURAL ELEMENTS	CEILING WALL GROUND	DIFFUSE VERSION fixed optics OPTICS VERSION fixed / tiltable optics	 2700K 3000K 4000K RGB	2–13W
CORSO see p. 124  MONUMENTAL AREAS	WALL GROUND	OPTICS VERSION fixed optics	 2700K 3000K 4000K	3.5–21W
STRA see p. 132  LARGE BUILDINGS	GROUND	OPTICS VERSION fixed / adjustable optics	 2700K 3000K 4000K RGBW	25–39W

AMBIENT LIGHTING

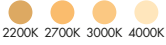
ALTOPIANO see p. 72  WALKWAYS AND SOCIAL SPACES	CEILING	DIFFUSE VERSION fixed optics OPTICS VERSION fixed optics	 2200K 2700K 3000K 4000K	8–20W
---	---------	---	--	-------

ORIENTATION

BEAM see p. 140  WALKWAYS	CEILING WALL GROUND	DIFFUSE VERSION fixed optics	 2700K 3000K 4000K 5000K blue RGB	max 3W
---	---------------------------	---------------------------------	--	--------

RECESSED FOR OUTDOOR APPLICATIONS

DELIVERED LUMEN OUTPUT (3000K)	SHAPE	IP	APPLIANCE CLASS	UNIQUE SELLING POINTS
200–1821 lm	MAINS VOLTAGE (built-in power supply unit) 110-230Vac	IP66 IP6872h		IP69K
188–1065 lm	CONSTANT CURRENT (power supply unit not included) max 700mA (white/RGB light) CONSTANT VOLTAGE (power supply unit not included) 24Vdc (white light)	IP67		
20–1235 lm	CONSTANT CURRENT (power supply unit not included) max 500mA (white/ blue/green/red/RGB light) CONSTANT VOLTAGE (power supply unit not included) 12Vac (white light) 12Vdc (white/RGB light) 24Vdc (white/blue/RGBW light)	IP65 IP67 IP68		IP69K
188–1065 lm	CONSTANT CURRENT (power supply unit not included) max 700mA (white/RGB light) CONSTANT VOLTAGE (power supply unit not included) 24Vdc (white light)	IP67		
178–1740 lm	MAINS VOLTAGE (built-in power supply unit) 110-230Vac 230Vac	IP65 IP67		IP69K
1350–2205 lm	CONSTANT VOLTAGE (power supply unit not included) 24Vdc (RGBW light) MAINS VOLTAGE (built-in power supply unit) 230Vac (white light)	IP67 IP68	 	IP69K
588–1988 lm	MAINS VOLTAGE (built-in power supply unit) 110-230Vac	IP66		
114 lm	CONSTANT CURRENT (power supply unit not included) max 350mA (RGB light) max 700mA (white/blue light)	IP67		

**FIXED OPTICS
WITHOUT SCREWS**

100x100 mm

2200K 2700K 3000K 4000K

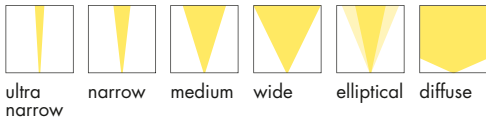

UP TO 2 m



QUILATERO 1.0 p. 63
3.5W
110-230Vac
ON/OFF

130x130 mm

2700K 3000K 4000K

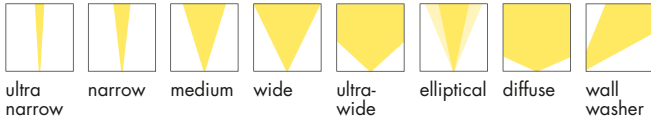

UP TO 4 m



QUILATERO 2.0 p. 64
8W / 6W (wall washer optics)
110-230Vac
ON/OFF

170x170 mm

2200K 2700K 3000K 4000K



UP TO 7 m



QUILATERO 3.0 p. 66
16W / 18W (wall washer optics)
110-230Vac
ON/OFF

210x210 mm

2200K 2700K 3000K 4000K

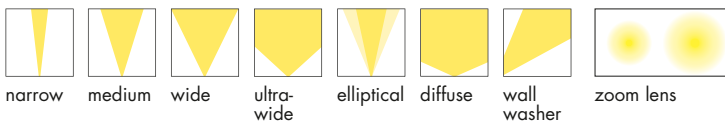

UP TO 10 m



QUILATERO 4.0 p. 68
22W / 19W (wall washer optics)
110-230Vac
230Vac
ON/OFF, DALI + PUSH

DRIVE-OVER OUTDOOR RECESSED UPLIGHTS WITH BUILT-IN POWER SUPPLY FOR FACADE LIGHTING

FIXED OPTICS WITH SCREWS



QUILATERO 1.1 p. 63
3.5W
110-230Vac
ON/OFF

TILTABLE OPTICS WITHOUT SCREWS

TILTABLE OPTICS WITH SCREWS



QUILATERO 2.1 p. 64
8W / 6W (wall washer optics)
110-230Vac
ON/OFF



QUILATERO 2.4 p. 65
8W
110-230Vac
ON/OFF



QUILATERO 2.5 p. 65
8W
110-230Vac
ON/OFF



QUILATERO 3.1 p. 66
16W / 18W (wall washer optics)
110-230Vac
ON/OFF



QUILATERO 3.4 p. 67
16W
110-230Vac
ON/OFF



QUILATERO 3.5 p. 67
16W
110-230Vac
ON/OFF



QUILATERO 4.1 p. 68
22W / 19W (wall washer optics)
110-230Vac
230Vac
ON/OFF, DALI + PUSH



QUILATERO 4.4 p. 69
22W
110-230Vac
230Vac
ON/OFF, DALI + PUSH



QUILATERO 4.5 p. 69
22W
110-230Vac
230Vac
ON/OFF, DALI + PUSH

17°

24°

32°

43° sharp

53°

17°x69°

30°x73°

diffuse

range min

range max

- wall washer



IP66
IP68^{72H}
SUITABLE FOR OUTDOOR APPLICATIONS



IP69K
RESISTANT TO CLEANING WITH HIGH-PRESSURE,
HIGH-TEMPERATURE SPRAY-DOWNS
(ISO 20653 COMPLIANT)



BUILT-IN PROTECTION SYSTEMS:
IPS
INTELLIGENT PROTECTION SYSTEM



PID
PROTECTIVE IMPEDANCE DEVICE



BUILT-IN POWER
SUPPLY UNIT



CRI 80 AND CRI >90 VERSIONS
FOR IMPROVED COLOUR RENDERING



DRIVE-OVER
UP TO 3000 KG



MAXIMUM RESISTANCE TO CORROSION
THE CARBON-FIBRE-REINFORCED SEMICRYSTALLINE
TECHNOPOLYMER USED FOR QUILATERO'S BODY IS RESISTANT
TO ATMOSPHERIC CONDITIONS, MAKING IT IDEAL FOR USE
IN SALINE CONDITIONS SUCH AS MARITIME SETTINGS.
BECAUSE IT IS A THERMALLY CONDUCTIVE MATERIAL ON A PAR
WITH STAINLESS STEEL, IT IS A HIGHLY EFFICIENT HEAT DISSIPATER,
SO THE POWER SUPPLY CAN BE HOUSED INSIDE THE BODY

SCREEN IN TRANSPARENT EXTRA-CLEAR GLASS, UP TO 12 MM THICK,
HIGH TRANSMITTANCE TO ENSURE CHROMATIC UNIFORMITY
OF LIGHT, SERIGRAPHED GREY (RAL 7015), AND TEMPERED
FOR EXCELLENT IMPACT AND SCRATCH RESISTANCE

TRIM WITHOUT VISIBLE SCREWS AND WITH
MOUNTING CLIPS BUILT INTO THE LIGHTING FIXTURE
FOR EASY INSTALLATION – THE FIXTURE IS SIMPLY
PRESSED INTO PLACE IN ITS OUTER CASING

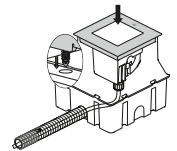

AVAILABLE IN COLOUR TEMPERATURES 2700K, 3000K AND
4000K, AND IN A WARM 2200K COLOUR TEMPERATURE,
TO BETTER RESPECT THE CIRCADIAN CYCLES OF PEOPLE
AND ANIMALS IN URBAN, GREEN AND PUBLIC SPACES

OPTICAL ACCESSORIES – HONEYCOMB LOUVRE AND
ANTI-GLARE SCREEN – CAN BE BUILT INTO THE FIXTURE

< WIDE RANGE OF OPTICS, FROM VERY NARROW TO SHARP OPTICS,
AND FROM WALL WASHER TO ELLIPTICAL OPTICS

UNIQUE SELLING POINTS



ON REQUEST:
RAL FINISH

STAINLESS STEEL



COR-TEN



THE AISI 316L STAINLESS STEEL TRIM IS AVAILABLE WITH OR WITHOUT VISIBLE SCREWS, WITH A **COR-TEN** FINISH OR CHOICE OF RAL FINISH: THIS VERSATILITY MEANS THAT QUILATERO INTEGRATES SEAMLESSLY INTO ARCHITECTURAL CONTEXTS WITH DIFFERENT STYLES AND INTENDED USES



THE WALL WASHER OPTICS ENABLE WALLS AND FACADES TO BE ILLUMINATED WITHOUT CONTRASTING SHADOWS WHEN THE LIGHT OUTPUT IS DIRECTED AT THE VERTICAL PLANE. AND THE WIDTH OF THE BEAM MEANS THE FIXTURES CAN BE SPACED FAR APART



THE MANUAL ZOOM LENS SATISFIES THE LIGHTING REQUIREMENTS OF LANDSCAPE DESIGN: A MAGNET ALLOWS YOU TO NARROW OR WIDEN THE LIGHT BEAM EXTERNALLY TO ADAPT IT TO CHANGES IN THE LANDSCAPING



MAGNETIC TILTING SYSTEM ALLOWS THE OPTICAL UNIT TO BE ANGLED EXTERNALLY FROM 0° TO 20°, MAINTAINING THE PRODUCT'S WATERTIGHTNESS. FURNISHED WITH GRADUATIONS AND LOCKING SCREW TO FIX THE ANGLE



PRODUCT COMPLETE WITH IP68 CONNECTOR AND BUILT-IN IPS SYSTEM. FAST INSTALLATION: DIRECT CONNECTION BETWEEN FIXTURE AND MAINS POWER SUPPLY



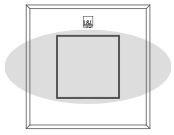

12°x45° optics

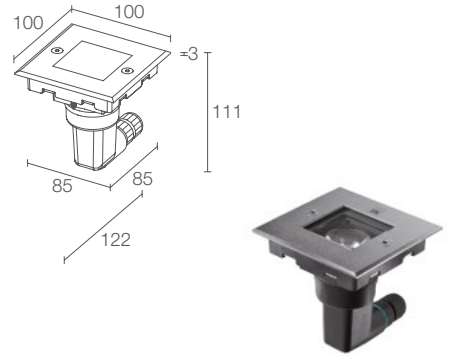
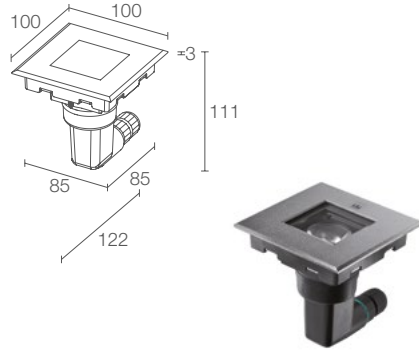

QUILATERO 1.0

Required outer casing, not included



POWER / POWER SUPPLY CODE

3.5W 110-230Vac
QL1010 ■ ■ ■ ■ ■ **I** Stainless steel
QL1010 ■ ■ ■ ■ ■ **T** Cor-ten
 3.5W 110-230Vac wall washer
QL1010 ■ **010** ■ **OAI** Stainless steel
QL1010 ■ **010** ■ **OAT** Cor-ten

■ CRI	0 - CRI 80 1 - CRI >90
■ OPTICAL ACCESSORIES	0 - none 1 - anti-glare screen, half transparent and half serigraphed black (not compatible with the honeycomb louvre and diffuse optics)
■ HONEYCOMB LOUVRE	0 - not present 1 - present (not compatible with the anti-glare screen, and sharp 35° and diffuse optics)
■ LED COLOUR	N - 2200K (only CRI 80) F - 2700K 5 - 3000K 9 - 4000K
■ OPTICS	OV - 7° OP - 35° sharp OT - 10° OL - 42° OS - 14° OW - 12°x45° OM - 32° OD - diffuse

LUMEN OUTPUT AT SOURCE	260 lm (3000K, CRI 80)
DELIVERED LUMEN OUTPUT	200 lm (3000K, 14°, CRI 80)
NO. AND TYPE OF LED	1 power LED 2-step MacAdam, 60000h L90 B10 (Ta 25°C)
MATERIAL	body in thermally conductive plastic trim in AISI 316L stainless steel screen in serigraphed-grey and transparent, tempered extra-clear glass
POWER SUPPLY UNIT	built in
MOUNTING	recessed (wall, ground)
FEATURES	fast installation: direct connection between fixture and mains power supply
NOTES	Casambi-compatible version, controllable with the Casambi app, available on request
PHOTOMETRIC DATA	see p. 866

QUILATERO 1.1

Required outer casing, not included



3.5W 110-230Vac
QL1110 ■ ■ ■ ■ ■ **I** Stainless steel
QL1110 ■ ■ ■ ■ ■ **T** Cor-ten
 3.5W 110-230Vac wall washer
QL1110 ■ **010** ■ **OAI** Stainless steel
QL1110 ■ **010** ■ **OAT** Cor-ten

■ CRI	0 - CRI 80 1 - CRI >90
■ OPTICAL ACCESSORIES	0 - none 1 - anti-glare screen, half transparent and half serigraphed black (not compatible with the honeycomb louvre and diffuse optics)
■ HONEYCOMB LOUVRE	0 - not present 1 - present (not compatible with the anti-glare screen, and sharp 35° and diffuse optics)
■ LED COLOUR	N - 2200K (only CRI 80) F - 2700K 5 - 3000K 9 - 4000K
■ OPTICS	OV - 7° OP - 35° sharp OT - 10° OL - 42° OS - 14° OW - 12°x45° OM - 32° OD - diffuse

LUMEN OUTPUT AT SOURCE	260 lm (3000K, CRI 80)
DELIVERED LUMEN OUTPUT	200 lm (3000K, 14°, CRI 80)
NO. AND TYPE OF LED	1 power LED 2-step MacAdam, 60000h L90 B10 (Ta 25°C)
MATERIAL	body in thermally conductive plastic trim in AISI 316L stainless steel screen in serigraphed-grey and transparent, tempered extra-clear glass
POWER SUPPLY UNIT	built in
MOUNTING	recessed (wall, ground)
FEATURES	fast installation: direct connection between fixture and mains power supply
NOTES	Casambi-compatible version, controllable with the Casambi app, available on request
PHOTOMETRIC DATA	see p. 866



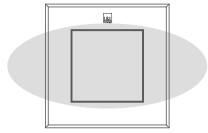

20°x47° optics

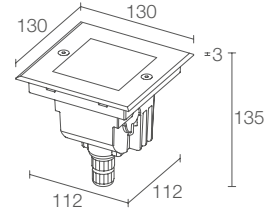
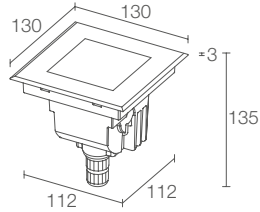

QUILATERO 2.0

Required outer casing, not included



POWER / POWER SUPPLY CODE

8W 110-230Vac
QL2010 0 1 2 3 4 5 6 7 8 9 I Stainless steel
QL2010 0 1 2 3 4 5 6 7 8 9 T Cor-ten

6W 110-230Vac wall washer
QL2010 000 0AI Stainless steel
QL2010 000 0AT Cor-ten

■ CRI	0 - CRI 80 1 - CRI >90
■ OPTICAL ACCESSORIES	0 - none 1 - anti-glare screen, half transparent and half serigraphed black (not compatible with the honeycomb louvre and diffuse optics)
■ HONEYCOMB LOUVRE	0 - not present 1 - present (not compatible with the anti-glare screen, and sharp 63°, diffuse optics)
■ LED COLOUR	F - 2700K 5 - 3000K 9 - 4000K
■ OPTICS	OV - 8° OL - 47° OT - 12° OQ - 63° sharp OS - 18° OW - 20°x47° OM - 34° OD - diffuse

LUMEN OUTPUT AT SOURCE	657 lm (3000K, CRI 80)
DELIVERED LUMEN OUTPUT	482 lm (3000K, 12°, CRI 80)
NO. AND TYPE OF LED	1 high-intensity power LED, 3-step MacAdam 50000h L90 B10 (Ta 25°C) 9 mid-power LEDs, 3-step MacAdam 50000h L80 B10 (Ta 25°C) (wall washer optics)
MATERIAL	body in thermally conductive plastic trim in AISI 316L stainless steel screen in serigraphed-grey and transparent, tempered extra-clear glass
POWER SUPPLY UNIT	built in
MOUNTING	recessed (wall, ground)
FEATURES	fast installation: direct connection between fixture and mains power supply
NOTES	Casambi-compatible version, controllable with the Casambi app, available on request
PHOTOMETRIC DATA	see p. 867

QUILATERO 2.1

Required outer casing, not included



8W 110-230Vac
QL2110 0 1 2 3 4 5 6 7 8 9 I Stainless steel
QL2110 0 1 2 3 4 5 6 7 8 9 T Cor-ten

6W 110-230Vac wall washer
QL2110 000 0AI Stainless steel
QL2110 000 0AT Cor-ten

■ CRI	0 - CRI 80 1 - CRI >90
■ OPTICAL ACCESSORIES	0 - none 1 - anti-glare screen, half transparent and half serigraphed black (not compatible with the honeycomb louvre and diffuse optics)
■ HONEYCOMB LOUVRE	0 - not present 1 - present (not compatible with the anti-glare screen, and sharp 63°, diffuse optics)
■ LED COLOUR	F - 2700K 5 - 3000K 9 - 4000K
■ OPTICS	OV - 8° OL - 47° OT - 12° OQ - 63° sharp OS - 18° OW - 20°x47° OM - 34° OD - diffuse

LUMEN OUTPUT AT SOURCE	657 lm (3000K, CRI 80)
DELIVERED LUMEN OUTPUT	482 lm (3000K, 12°, CRI 80)
NO. AND TYPE OF LED	1 high-intensity power LED, 3-step MacAdam 50000h L90 B10 (Ta 25°C) 9 mid-power LEDs, 3-step MacAdam 50000h L80 B10 (Ta 25°C) (wall washer optics)
MATERIAL	body in thermally conductive plastic trim in AISI 316L stainless steel screen in serigraphed-grey and transparent, tempered extra-clear glass
POWER SUPPLY UNIT	built in
MOUNTING	recessed (wall, ground)
FEATURES	fast installation: direct connection between fixture and mains power supply
NOTES	Casambi-compatible version, controllable with the Casambi app, available on request
PHOTOMETRIC DATA	see p. 867



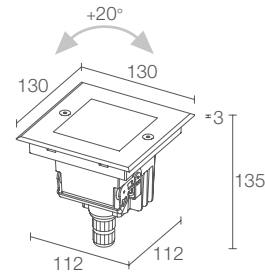
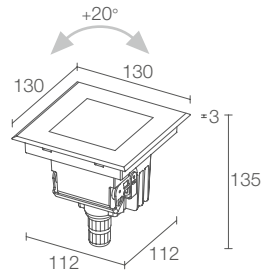

QUILATERO 2.4

Required outer casing, not included



POWER / POWER SUPPLY CODE	8W 110-230Vac QL2410 ■ ■ ■ ■ ■ I Stainless steel QL2410 ■ ■ ■ ■ ■ T Cor-ten
CRI	0 - CRI 80 1 - CRI >90
OPTICAL ACCESSORIES	0 - none 1 - anti-glare screen, half transparent and half serigraphed black (not compatible with the honeycomb louvre)
HONEYCOMB LOUVRE	0 - not present 1 - present (not compatible with the anti-glare screen and sharp 63° optics)
LED COLOUR	F - 2700K 5 - 3000K 9 - 4000K
OPTICS	OV - 8° tiltable +20° OT - 12° tiltable +20° OS - 18° tiltable +20° OM - 34° tiltable +20° OL - 47° tiltable +20° OQ - 63° sharp tiltable +20° OW - 20°x47° tiltable +20°

LUMEN OUTPUT AT SOURCE	657 lm (3000K, CRI 80)
DELIVERED LUMEN OUTPUT	482 lm (3000K, 12°, CRI 80)
NO. AND TYPE OF LED	1 high-intensity power LED 3-step MacAdam, 50000h L90 B10 (Ta 25°C)
MATERIAL	body in thermally conductive plastic trim in AISI 316L stainless steel screen in serigraphed-grey and transparent, tempered extra-clear glass
POWER SUPPLY UNIT	built in
MOUNTING	recessed (wall, ground)
FEATURES	optics tiltable by up to 20° by means of a magnetic system with graduations and locking screw fast installation: direct connection between fixture and mains power supply
NOTES	Casambi-compatible version, controllable with the Casambi app, available on request
PHOTOMETRIC DATA	see p. 867

QUILATERO 2.5

Required outer casing, not included



POWER / POWER SUPPLY CODE	8W 110-230Vac QL2510 ■ ■ ■ ■ ■ I Stainless steel QL2510 ■ ■ ■ ■ ■ T Cor-ten
CRI	0 - CRI 80 1 - CRI >90
OPTICAL ACCESSORIES	0 - none 1 - anti-glare screen, half transparent and half serigraphed black (not compatible with the honeycomb louvre)
HONEYCOMB LOUVRE	0 - not present 1 - present (not compatible with the anti-glare screen and sharp 63° optics)
LED COLOUR	F - 2700K 5 - 3000K 9 - 4000K
OPTICS	OV - 8° tiltable +20° OT - 12° tiltable +20° OS - 18° tiltable +20° OM - 34° tiltable +20° OL - 47° tiltable +20° OQ - 63° sharp tiltable +20° OW - 20°x47° tiltable +20°

LUMEN OUTPUT AT SOURCE	657 lm (3000K, CRI 80)
DELIVERED LUMEN OUTPUT	482 lm (3000K, 12°, CRI 80)
NO. AND TYPE OF LED	1 high-intensity power LED 3-step MacAdam, 50000h L90 B10 (Ta 25°C)
MATERIAL	body in thermally conductive plastic trim in AISI 316L stainless steel screen in serigraphed-grey and transparent, tempered extra-clear glass
POWER SUPPLY UNIT	built in
MOUNTING	recessed (wall, ground)
FEATURES	optics tiltable by up to 20° by means of a magnetic system with graduations and locking screw fast installation: direct connection between fixture and mains power supply
NOTES	Casambi-compatible version, controllable with the Casambi app, available on request
PHOTOMETRIC DATA	see p. 867



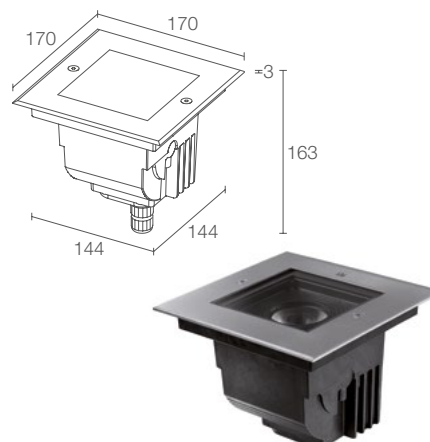
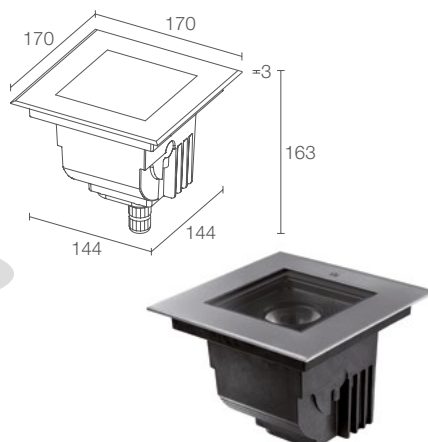
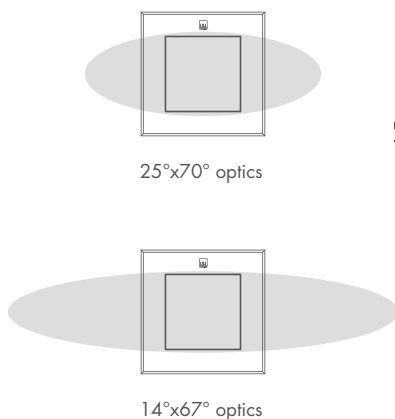

QUILATERO 3.0

Required outer casing, not included



16W 110-230Vac
QL3010 0 1 2 3 4 5 6 7 8 9 I Stainless steel
QL3010 0 1 2 3 4 5 6 7 8 9 T Cor-ten
 18W 110-230Vac wall washer
QL3010 000 0A1 Stainless steel
QL3010 000 0A1 Cor-ten

■ CRI	0 - CRI 80 1 - CRI >90
■ OPTICAL ACCESSORIES	0 - none 1 - anti-glare screen, half transparent and half serigraphed black (not compatible with the honeycomb louvre and diffuse optics)
■ HONEYCOMB LOUVRE	0 - not present 1 - present (not compatible with the anti-glare screen, sharp 57°, 14°x67°, 25°x70° and diffuse optics, and the 18°-48° zoom lens)
■ LED COLOUR	N - 2200K (only CRI 80) F - 2700K 5 - 3000K 9 - 4000K
■ OPTICS	OS - 14° OM - 26° OL - 39° OK - 57° OQ - 57° sharp OW - 14°x67° OX - 25°x70° R3 - optical range 18°-48° OD - diffuse

LUMEN OUTPUT AT SOURCE	1616 lm (3000K, CRI 80)
DELIVERED LUMEN OUTPUT	1226 lm (3000K, 26°, CRI 80)
NO. AND TYPE OF LED	1 COB LED, 2-step MacAdam 60000h L80 B10 (Ta 25°C) 14 mid-power LEDs, 3-step MacAdam 50000h L80 B10 (Ta 25°C) (wall washer optics)
MATERIAL	body in thermally conductive plastic trim in AISI 316L stainless steel screen in serigraphed-grey and transparent, tempered extra-clear glass
POWER SUPPLY UNIT	built in
MOUNTING	recessed (wall, ground)
FEATURES	manual zoom lens adjustable using magnet included fast installation: direct connection between fixture and mains power supply
NOTES	Casambi-compatible version, controllable with the Casambi app, available on request
PHOTOMETRIC DATA	see p. 868

QUILATERO 3.1

Required outer casing, not included



16W 110-230Vac
QL3110 0 1 2 3 4 5 6 7 8 9 I Stainless steel
QL3110 0 1 2 3 4 5 6 7 8 9 T Cor-ten
 18W 110-230Vac wall washer
QL3110 000 0A1 Stainless steel
QL3110 000 0A1 Cor-ten

■ CRI	0 - CRI 80 1 - CRI >90
■ OPTICAL ACCESSORIES	0 - none 1 - anti-glare screen, half transparent and half serigraphed black (not compatible with the honeycomb louvre and diffuse optics)
■ HONEYCOMB LOUVRE	0 - not present 1 - present (not compatible with the anti-glare screen, sharp 57°, 14°x67°, 25°x70° and diffuse optics, and the 18°-48° zoom lens)
■ LED COLOUR	N - 2200K (only CRI 80) F - 2700K 5 - 3000K 9 - 4000K
■ OPTICS	OS - 14° OM - 26° OL - 39° OK - 57° OQ - 57° sharp OW - 14°x67° OX - 25°x70° R3 - optical range 18°-48° OD - diffuse

LUMEN OUTPUT AT SOURCE	1616 lm (3000K, CRI 80)
DELIVERED LUMEN OUTPUT	1226 lm (3000K, 26°, CRI 80)
NO. AND TYPE OF LED	1 COB LED, 2-step MacAdam 60000h L80 B10 (Ta 25°C) 14 mid-power LEDs, 3-step MacAdam 50000h L80 B10 (Ta 25°C) (wall washer optics)
MATERIAL	body in thermally conductive plastic trim in AISI 316L stainless steel screen in serigraphed-grey and transparent, tempered extra-clear glass
POWER SUPPLY UNIT	built in
MOUNTING	recessed (wall, ground)
FEATURES	manual zoom lens adjustable using magnet included fast installation: direct connection between fixture and mains power supply
NOTES	Casambi-compatible version, controllable with the Casambi app, available on request
PHOTOMETRIC DATA	see p. 868



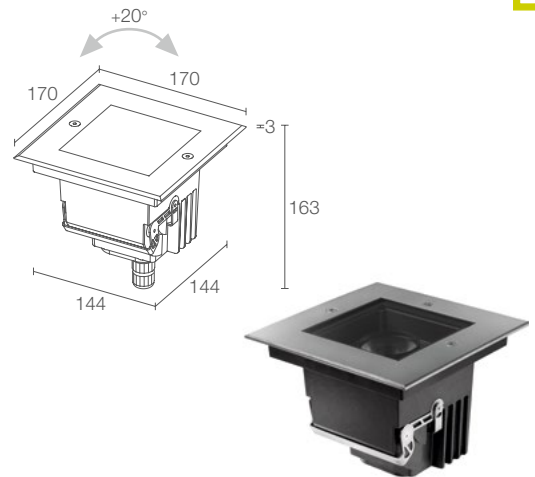
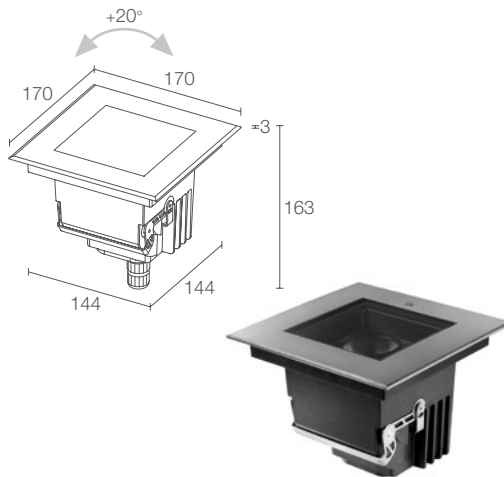

QUILATERO 3.4

Required outer casing, not included



IP66 IP6872h IP69K IK10



POWER / POWER SUPPLY CODE

16W 110-230Vac
QL3410 **I** Stainless steel
QL3410 **T** Cor-ten

CRI	0 - CRI 80 1 - CRI >90
OPTICAL ACCESSORIES	0 - none 1 - anti-glare screen, half transparent and half serigraphed black (not compatible with the honeycomb louvre)
HONEYCOMB LOUVRE	0 - not present 1 - present (not compatible with the anti-glare screen and sharp 57°, 14°x67° and 25°x70° optics)
LED COLOUR	N - 2200K (only CRI 80) F - 2700K 5 - 3000K 9 - 4000K
OPTICS	OS - 14° tiltable +20° OM - 26° tiltable +20° OL - 39° tiltable +20° OK - 57° tiltable +20° OQ - 57° sharp tiltable +20° OW - 14°x67° tiltable +20° OX - 25°x70° tiltable +20°

QUILATERO 3.5

Required outer casing, not included



IP66 IP6872h IP69K IK10



16W 110-230Vac
QL3510 **I** Stainless steel
QL3510 **T** Cor-ten

CRI	0 - CRI 80 1 - CRI >90
OPTICAL ACCESSORIES	0 - none 1 - anti-glare screen, half transparent and half serigraphed black (not compatible with the honeycomb louvre)
HONEYCOMB LOUVRE	0 - not present 1 - present (not compatible with the anti-glare screen and sharp 57°, 14°x67° and 25°x70° optics)
LED COLOUR	N - 2200K (only CRI 80) F - 2700K 5 - 3000K 9 - 4000K
OPTICS	OS - 14° tiltable +20° OM - 26° tiltable +20° OL - 39° tiltable +20° OK - 57° tiltable +20° OQ - 57° sharp tiltable +20° OW - 14°x67° tiltable +20° OX - 25°x70° tiltable +20°

LUMEN OUTPUT AT SOURCE	1616 lm (3000K, CRI 80)
DELIVERED LUMEN OUTPUT	1226 lm (3000K, 26°, CRI 80)
NO. AND TYPE OF LED	1 COB LED 2-step MacAdam, 60000h L80 B10 (Ta 25°C)
MATERIAL	body in thermally conductive plastic trim in AISI 316L stainless steel screen in serigraphed-grey and transparent, tempered extra-clear glass
POWER SUPPLY UNIT	built in
MOUNTING	recessed (wall, ground)
FEATURES	optics tiltable by up to 20° by means of a magnetic system with graduations and locking screw fast installation: direct connection between fixture and mains power supply
NOTES	Casambi-compatible version, controllable with the Casambi app, available on request
PHOTOMETRIC DATA	see p. 868

LUMEN OUTPUT AT SOURCE	1616 lm (3000K, CRI 80)
DELIVERED LUMEN OUTPUT	1226 lm (3000K, 26°, CRI 80)
NO. AND TYPE OF LED	1 COB LED 2-step MacAdam, 60000h L80 B10 (Ta 25°C)
MATERIAL	body in thermally conductive plastic trim in AISI 316L stainless steel screen in serigraphed-grey and transparent, tempered extra-clear glass
POWER SUPPLY UNIT	built in
MOUNTING	recessed (wall, ground)
FEATURES	optics tiltable by up to 20° by means of a magnetic system with graduations and locking screw fast installation: direct connection between fixture and mains power supply
NOTES	Casambi-compatible version, controllable with the Casambi app, available on request
PHOTOMETRIC DATA	see p. 868



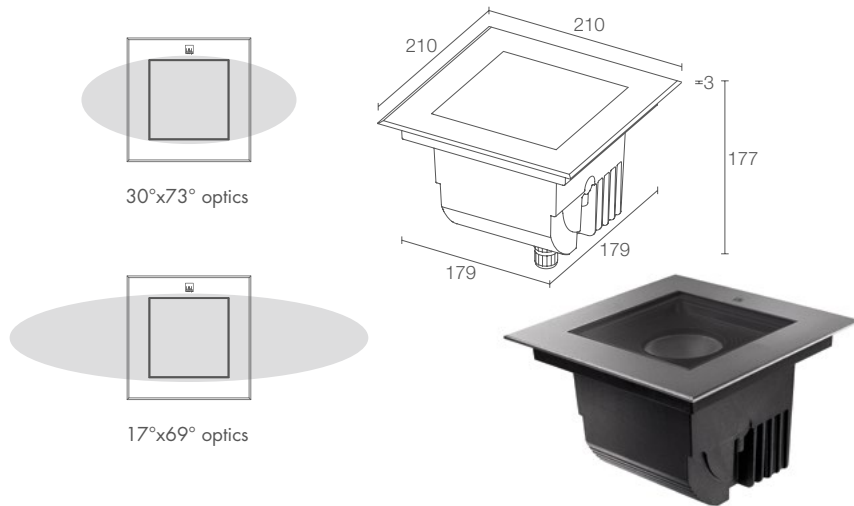

QUILATERO 4.0

Required outer casing, not included



22W 110-230Vac on/off	22W 230Vac DALI + PUSH
QL4010 [Color Options]	Stainless steel
QL4010 [Color Options]	Cor-ten
19W 110-230Vac wall washer	
QL4010 [Color Options]	Stainless steel
QL4010 [Color Options]	Cor-ten

■ CRI	0 - CRI 80 1 - CRI >90
■ CONTROL SYSTEM	0 - on/off D - DALI + PUSH
■ OPTICAL ACCESSORIES	0 - none 1 - anti-glare screen, half transparent and half serigraphed black (not compatible with the honeycomb louvre and diffuse optics)
■ HONEYCOMB LOUVRE	0 - not present 1 - present (not compatible with the anti-glare screen and sharp 43°, 17°x69°, 30°x73° and diffuse optics, and the 20°-41° zoom lens)
■ LED COLOUR	N - 2200K (only CRI 80) F - 2700K 5 - 3000K 9 - 4000K
■ OPTICS	OS - 17° OM - 24° OL - 32° OP - 43° sharp OJ - 53° OW - 17°x69° OX - 30°x73° R3 - optical range 20°-41° OD - diffuse

LUMEN OUTPUT AT SOURCE	2469 lm (3000K, CRI 80)
DELIVERED LUMEN OUTPUT	1821 lm (3000K, 17°, CRI 80)
NO. AND TYPE OF LED	1 COB LED, 2-step MacAdam 60000h L80 B10 (Ta 25°C) 22 mid power LEDs, 3-step MacAdam 50000h L80 B10 (Ta 25°C) (wall washer optics)
MATERIAL	body in thermally conductive plastic; trim in AISI 316L stainless steel; screen in serigraphed-grey and transparent, tempered extra-clear glass
POWER SUPPLY UNIT	built in
MOUNTING	recessed (wall, ground)
FEATURES	manual zoom lens adjustable using magnet included fast installation: direct connection between fixture and mains power supply
NOTES	Casambi-compatible version, controllable with the Casambi app, available on request
PHOTOMETRIC DATA	see p. 869

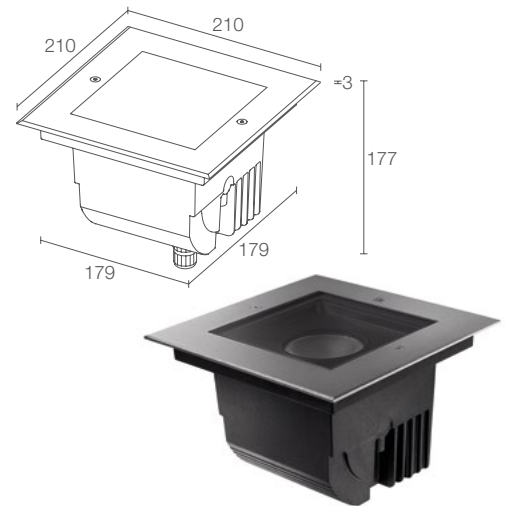

QUILATERO 4.1

Required outer casing, not included



22W 110-230Vac on/off	22W 230Vac DALI + PUSH
QL4110 [Color Options]	Stainless steel
QL4110 [Color Options]	Cor-ten
19W 110-230Vac wall washer	
QL4110 [Color Options]	Stainless steel
QL4110 [Color Options]	Cor-ten

■ CRI	0 - CRI 80 1 - CRI >90
■ CONTROL SYSTEM	0 - on/off D - DALI + PUSH
■ OPTICAL ACCESSORIES	0 - none 1 - anti-glare screen, half transparent and half serigraphed black (not compatible with the honeycomb louvre and diffuse optics)
■ HONEYCOMB LOUVRE	0 - not present 1 - present (not compatible with the anti-glare screen and sharp 43°, 17°x69°, 30°x73° and diffuse optics, and the 20°-41° zoom lens)
■ LED COLOUR	N - 2200K (only CRI 80) F - 2700K 5 - 3000K 9 - 4000K
■ OPTICS	OS - 17° OM - 24° OL - 32° OP - 43° sharp OJ - 53° OW - 17°x69° OX - 30°x73° R3 - optical range 20°-41° OD - diffuse

LUMEN OUTPUT AT SOURCE	2469 lm (3000K, CRI 80)
DELIVERED LUMEN OUTPUT	1821 lm (3000K, 17°, CRI 80)
NO. AND TYPE OF LED	1 COB LED, 2-step MacAdam 60000h L80 B10 (Ta 25°C) 22 mid power LEDs, 3-step MacAdam 50000h L80 B10 (Ta 25°C) (wall washer optics)
MATERIAL	body in thermally conductive plastic; trim in AISI 316L stainless steel; screen in serigraphed-grey and transparent, tempered extra-clear glass
POWER SUPPLY UNIT	built in
MOUNTING	recessed (wall, ground)
FEATURES	manual zoom lens adjustable using magnet included fast installation: direct connection between fixture and mains power supply
NOTES	Casambi-compatible version, controllable with the Casambi app, available on request
PHOTOMETRIC DATA	see p. 869



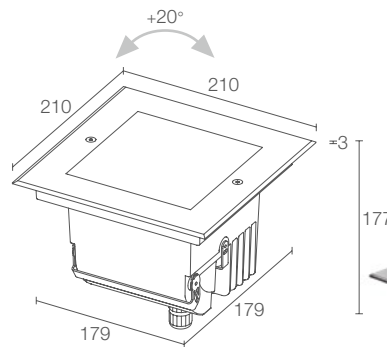
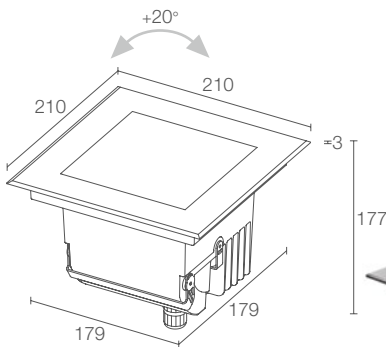

QUILATERO 4.4

Required outer casing, not included

CE ENEC LED 3000K 30 kg 2.63

IP66 IP6872h IP69K IK10 DALI PUSH

A A+ A++ IPS T max 40°C

POWER / POWER SUPPLY CODE

22W 110-230Vac on/off
22W 230Vac DALI + PUSH

QL4410 ■■■■ I Stainless steel
QL4410 ■■■■ T Cor-ten

■ CRI	0 - CRI 80 1 - CRI >90
■ CONTROL SYSTEM	0 - on/off D - DALI + PUSH
■ OPTICAL ACCESSORIES	0 - none 1 - anti-glare screen, half transparent and half serigraphed black (not compatible with the honeycomb louvre)
■ HONEYCOMB LOUVRE	0 - not present 1 - present (not compatible with the anti-glare screen and sharp 43°, 17°x69° and 30°x73° optics)
■ LED COLOUR	N - 2200K (only CRI 80) F - 2700K 5 - 3000K 9 - 4000K
■ OPTICS	OS - 17° tiltable +20° OM - 24° tiltable +20° OL - 32° tiltable +20° OP - 43° sharp tiltable +20° OJ - 53° tiltable +20° OW - 17°x69° tiltable +20° OX - 30°x73° tiltable +20°

LUMEN OUTPUT AT SOURCE	2469 lm (3000K, CRI 80)
DELIVERED LUMEN OUTPUT	1821 lm (3000K, 17°, CRI 80)
NO. AND TYPE OF LED	1 COB LED 2-step MacAdam, 60000h L80 B10 (Ta 25°C)
MATERIAL	body in thermally conductive plastic trim in AISI 316L stainless steel screen in serigraphed-grey and transparent, tempered extra-clear glass
POWER SUPPLY UNIT	built in
MOUNTING	recessed (wall, ground)
FEATURES	optics tiltable by up to 20° by means of a magnetic system with graduations and locking screw fast installation: direct connection between fixture and mains power supply
NOTES	Casambi-compatible version, controllable with the Casambi app, available on request
PHOTOMETRIC DATA	see p. 869

QUILATERO 4.5

Required outer casing, not included

CE ENEC LED 3000K 30 kg 2.63

IP66 IP6872h IP69K IK10 DALI PUSH

A A+ A++ IPS T max 40°C

22W 110-230Vac on/off
22W 230Vac DALI + PUSH

QL4510 ■■■■ I Stainless steel
QL4510 ■■■■ T Cor-ten

■ CRI	0 - CRI 80 1 - CRI >90
■ CONTROL SYSTEM	0 - on/off D - DALI + PUSH
■ OPTICAL ACCESSORIES	0 - none 1 - anti-glare screen, half transparent and half serigraphed black (not compatible with the honeycomb louvre)
■ HONEYCOMB LOUVRE	0 - not present 1 - present (not compatible with the anti-glare screen and sharp 43°, 17°x69° and 30°x73° optics)
■ LED COLOUR	N - 2200K (only CRI 80) F - 2700K 5 - 3000K 9 - 4000K
■ OPTICS	OS - 17° tiltable +20° OM - 24° tiltable +20° OL - 32° tiltable +20° OP - 43° sharp tiltable +20° OJ - 53° tiltable +20° OW - 17°x69° tiltable +20° OX - 30°x73° tiltable +20°

LUMEN OUTPUT AT SOURCE	2469 lm (3000K, CRI 80)
DELIVERED LUMEN OUTPUT	1821 lm (3000K, 17°, CRI 80)
NO. AND TYPE OF LED	1 COB LED 2-step MacAdam, 60000h L80 B10 (Ta 25°C)
MATERIAL	body in thermally conductive plastic trim in AISI 316L stainless steel screen in serigraphed-grey and transparent, tempered extra-clear glass
POWER SUPPLY UNIT	built in
MOUNTING	recessed (wall, ground)
FEATURES	optics tiltable by up to 20° by means of a magnetic system with graduations and locking screw fast installation: direct connection between fixture and mains power supply
NOTES	Casambi-compatible version, controllable with the Casambi app, available on request
PHOTOMETRIC DATA	see p. 869





ACCESSORIES

ACCESSORIES FOR INSTALLATION

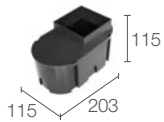

WCA13
Outer casing
(Quilatero 1)

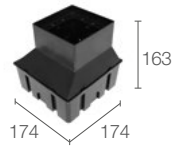

WCA14
Outer casing
(Quilatero 2)

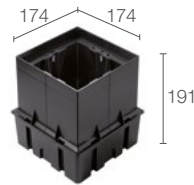

WCA15
Outer casing
(Quilatero 3)

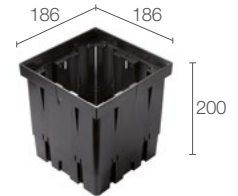

WCA16
Outer casing
(Quilatero 4)

for spare parts, see p. 932



ALTOPIANO

OUTDOOR DOWNLIGHT FOR RESIDENTIAL AND HOSPITALITY SETTINGS, SUITABLE FOR USE IN DAMP LOCATIONS, SUCH AS SPAS AND BASEMENTS

2200K 2700K 3000K 4000K

ROUND COVER

SQUARE COVER

Ø98 mm

98x98 mm



ALTOPIANO 1.0 p. 74
8W 110-230Vac

ALTOPIANO 1.1 p. 74
8W 110-230Vac

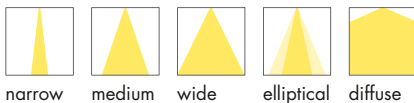

narrow medium wide elliptical diffuse

Ø120 mm

120x120 mm



ALTOPIANO 2.0 p. 75
16W 110-230Vac

ALTOPIANO 2.1 p. 75
16W 110-230Vac



narrow medium wide ultra-wide elliptical diffuse

Ø140 mm

140x140 mm



ALTOPIANO 3.0 p. 76
20W 110-230Vac

ALTOPIANO 3.1 p. 77
20W 110-230Vac



narrow medium wide ultra-wide elliptical diffuse

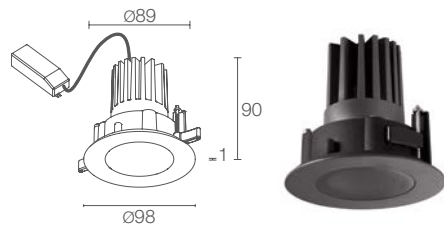

ALTOPIANO 1.0

Ø 225 mm
H 175 mm Ø 90 mm

CE ENEC LED ENEC kg 0.60 IP66 IK08
A A+ A++ DALI-2

POWER / POWER SUPPLY CODE

8W 110-230Vac
AP1010 0 0 0 0 E White
AP1010 0 0 0 0 F Grey
AP1010 0 0 0 0 H Anthracite
AP1010 0 0 0 0 T Cor-ten
AP1010 0 0 0 0 7 Primer

CRI	0 - CRI 80 1 - CRI >90
CONTROL SYSTEM	0 - on/off D - DALI-2
OPTICAL ACCESSORIES	0 - none 1 - honeycomb louvre (not compatible with diffuse and 23°x64° optics) 2 - anti-glare shield with concentric rings (not compatible with diffuse and 23°x64° optics)
LED COLOUR	N - 2200K (only CRI >90) F - 2700K 5 - 3000K 9 - 4000K
OPTICS	S - 19° M - 25° L - 37° K - 50° W - 23°x64° D - diffuse

LUMEN OUTPUT AT SOURCE	921 lm (3000K, CRI 80)
DELIVERED LUMEN OUTPUT	588 lm (3000K, 25°, CRI 80)
NO. AND TYPE OF LED	1 COB LED 2-step MacAdam, 60000h L90 B10 (Ta 25°C)
MATERIAL	body in thermally conductive plastic screen in grey-serigraphed and transparent, tempered extra-clear glass trim in stainless steel
POWER SUPPLY UNIT	included and wired
POWER CABLES	includes 0.50 m neoprene cable H07RN-F 2x1.0 Ø8.0 mm
MOUNTING	recessed (ceiling)
FEATURES	UGR < 19 for 19°, 25° and 37° optics Trim in magnetic stainless steel for an aesthetic with no visible screws
NOTES	Casambi-compatible version, controllable with the Casambi app, available on request
PHOTOMETRIC DATA	see p. 779

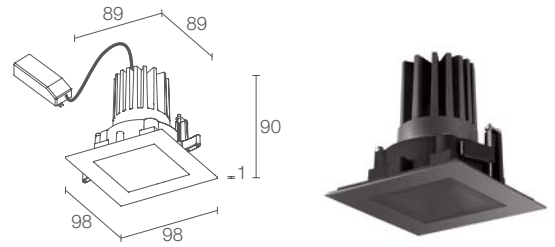

ALTOPIANO 1.1

Ø 225 mm
H 175 mm 90x90 mm

CE ENEC LED ENEC kg 0.60 IP66 IK07
A A+ A++ DALI-2

8W 110-230Vac
AP1110 0 0 0 0 E White
AP1110 0 0 0 0 F Grey
AP1110 0 0 0 0 H Anthracite
AP1110 0 0 0 0 T Cor-ten
AP1110 0 0 0 0 7 Primer

CRI	0 - CRI 80 1 - CRI >90
CONTROL SYSTEM	0 - on/off D - DALI-2
OPTICAL ACCESSORIES	0 - none 1 - honeycomb louvre (not compatible with diffuse and 23°x64° optics) 2 - anti-glare shield with concentric rings (not compatible with diffuse and 23°x64° optics)
LED COLOUR	N - 2200K (only CRI >90) F - 2700K 5 - 3000K 9 - 4000K
OPTICS	S - 19° M - 25° L - 37° K - 50° W - 23°x64° D - diffuse

LUMEN OUTPUT AT SOURCE	921 lm (3000K, CRI 80)
DELIVERED LUMEN OUTPUT	588 lm (3000K, 25°, CRI 80)
NO. AND TYPE OF LED	1 COB LED 2-step MacAdam, 60000h L90 B10 (Ta 25°C)
MATERIAL	body in thermally conductive plastic screen in grey-serigraphed and transparent, tempered extra-clear glass trim in stainless steel
POWER SUPPLY UNIT	included and wired
POWER CABLES	includes 0.50 m neoprene cable H07RN-F 2x1.0 Ø8.0 mm
MOUNTING	recessed (ceiling)
FEATURES	UGR < 19 for 19°, 25° and 37° optics Trim in magnetic stainless steel for an aesthetic with no visible screws
NOTES	Casambi-compatible version, controllable with the Casambi app, available on request
PHOTOMETRIC DATA	see p. 779

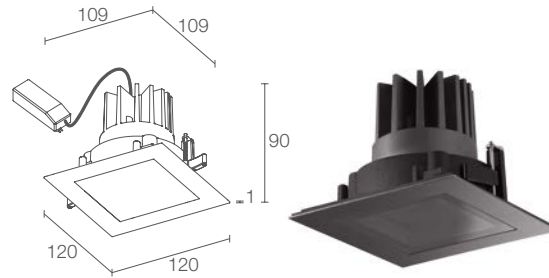
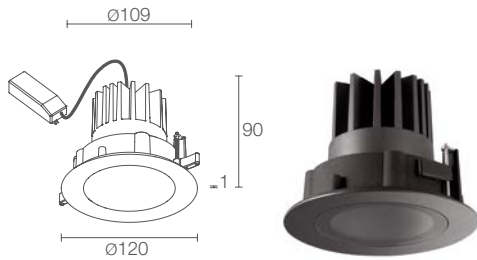

ALTOPIANO 2.0

Ø 275 mm
H 175 mm
Ø 110 mm

CE ENEC LED ENEC
A A+ A++
kg 0.70 IP66 IK08
DALI-2

16W 110-230Vac

AP2010 ■ ■ ■ ■ ■ ■ **E** White
 AP2010 ■ ■ ■ ■ ■ ■ **F** Grey
 AP2010 ■ ■ ■ ■ ■ ■ **H** Anthracite
 AP2010 ■ ■ ■ ■ ■ ■ **T** Cor-ten
 AP2010 ■ ■ ■ ■ ■ ■ **7** Primer

■	0 - CRI 80 1 - CRI >90
■	0 - on/off D - DALI-2
■	0 - none 1 - honeycomb louvre (not compatible with diffuse and 16°x67° optics) 2 - anti-glare shield with concentric rings (not compatible with diffuse and 16°x67° optics)
■	N - 2200K (only CRI >90) F - 2700K 5 - 3000K 9 - 4000K
■	S - 16° M - 26° L - 38° K - 57° W - 16°x67° D - diffuse

1616 lm (3000K, CRI 80)

1251 lm (3000K, 57°, CRI 80)

1 COB LED
2-step MacAdam, 60000h L90 B10 (Ta 25°C)

body in thermally conductive plastic
screen in grey-serigraphed and transparent,
tempered extra-clear glass
trim in stainless steel

included and wired

includes 0.50 m neoprene cable
H07RN-F 2x1.0 Ø8.0 mm

recessed (ceiling)

UGR < 19 for 16°, 26° and 38° optics
Trim in magnetic stainless steel for an aesthetic
with no visible screws

Casambi-compatible version, controllable with the
Casambi app, available on request

see p. 779

ALTOPIANO 2.1

Ø 275 mm
H 175 mm
110x110 mm

CE ENEC LED ENEC
A A+ A++
kg 0.70 IP66 IK07
DALI-2

16W 110-230Vac

AP2110 ■ ■ ■ ■ ■ ■ **E** White
 AP2110 ■ ■ ■ ■ ■ ■ **F** Grey
 AP2110 ■ ■ ■ ■ ■ ■ **H** Anthracite
 AP2110 ■ ■ ■ ■ ■ ■ **T** Cor-ten
 AP2110 ■ ■ ■ ■ ■ ■ **7** Primer

■	0 - CRI 80 1 - CRI >90
■	0 - on/off D - DALI-2
■	0 - none 1 - honeycomb louvre (not compatible with diffuse and 16°x67° optics) 2 - anti-glare shield with concentric rings (not compatible with diffuse and 16°x67° optics)
■	N - 2200K (only CRI >90) F - 2700K 5 - 3000K 9 - 4000K
■	S - 16° M - 26° L - 38° K - 57° W - 16°x67° D - diffuse

1616 lm (3000K, CRI 80)

1251 lm (3000K, 57°, CRI 80)

1 COB LED
2-step MacAdam, 60000h L90 B10 (Ta 25°C)

body in thermally conductive plastic
screen in grey-serigraphed and transparent,
tempered extra-clear glass
trim in stainless steel

included and wired

includes 0.50 m neoprene cable
H07RN-F 2x1.0 Ø8.0 mm

recessed (ceiling)

UGR < 19 for 16°, 26° and 38° optics
Trim in magnetic stainless steel for an aesthetic
with no visible screws

Casambi-compatible version, controllable with the
Casambi app, available on request

see p. 779

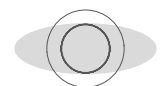

23°x64° optics
(Altopiano 1.0)

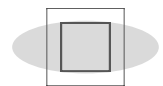

23°x64° optics
(Altopiano 1.1)

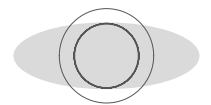

16°x67° optics
(Altopiano 2.0)

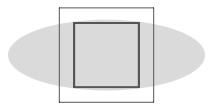

16°x67° optics
(Altopiano 2.1)



White



Grey



Anthracite



Cor-ten



Primer

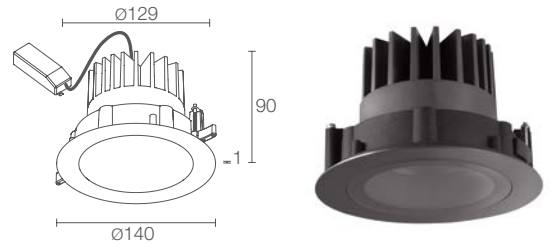

ALTOPIANO 3.0

Ø 320 mm
H 175 mm

Ø 130 mm

CE ENEC LEB
kg 0.80 IP66 IK08
A A+ A++ DALI-2

POWER / POWER SUPPLY CODE

20W 110-230Vac

AP3010 0 0 0 0 E White
AP3010 0 0 0 0 F Grey
AP3010 0 0 0 0 H Anthracite
AP3010 0 0 0 0 T Cor-ten
AP3010 0 0 0 0 7 Primer

CRI	0 - CRI 80 1 - CRI >90
CONTROL SYSTEM	0 - on/off D - DALI-2
OPTICAL ACCESSORIES	0 - none 1 - honeycomb louvre (not compatible with diffuse and 20°x72° optics) 2 - anti-glare shield with concentric rings (not compatible with diffuse and 20°x72° optics)
LED COLOUR	N - 2200K (only CRI >90) F - 2700K 5 - 3000K 9 - 4000K
OPTICS	S - 18° M - 24° L - 37° K - 61° W - 20°x72° D - diffuse

LUMEN OUTPUT AT SOURCE	2469 lm (3000K, CRI 80)
DELIVERED LUMEN OUTPUT	1988 lm (3000K, 18°, CRI 80)
NO. AND TYPE OF LED	1 COB LED 2-step MacAdam, 60000h L90 B10 (Ta 25°C)
MATERIAL	body in thermally conductive plastic screen in grey-serigraphed and transparent, tempered extra-clear glass trim in stainless steel
POWER SUPPLY UNIT	included and wired
POWER CABLES	includes 0.50 m neoprene cable H07RN-F 2x1.0 Ø8.0 mm
MOUNTING	recessed (ceiling)
FEATURES	UGR < 19 for 18°, 24° and 37° optics Trim in magnetic stainless steel for an aesthetic with no visible screws
NOTES	Casambi-compatible version, controllable with the Casambi app, available on request
PHOTOMETRIC DATA	see p. 780

ALTOPIANO 3.1
painted primer version



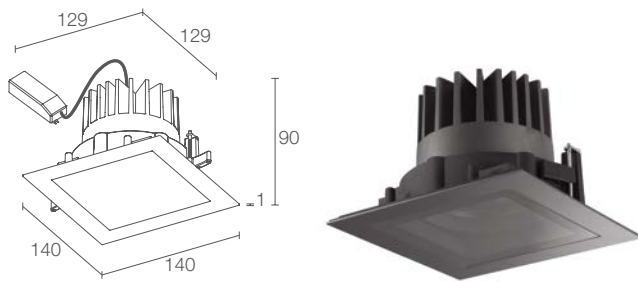

ALTOPIANO 3.1

Ø 320 mm
H 175 mm
130x130 mm

CE ENEC LED ENEC
A A+ A++
kg 0.80 IP66 IK07
DALI-2

20W 110-230Vac

AP3110 ■ ■ ■ ■ ■ ■ ■ **E** White
 AP3110 ■ ■ ■ ■ ■ ■ ■ **F** Grey
 AP3110 ■ ■ ■ ■ ■ ■ ■ **H** Anthracite
 AP3110 ■ ■ ■ ■ ■ ■ ■ **T** Cor-ten
 AP3110 ■ ■ ■ ■ ■ ■ ■ **7** Primer

■	0 - CRI 80 1 - CRI >90
■	0 - on/off D - DALI-2
■	0 - none 1 - honeycomb louvre (not compatible with diffuse and 20°x72° optics) 2 - anti-glare shield with concentric rings (not compatible with diffuse and 20°x72° optics)
■	N - 2200K (only CRI >90) F - 2700K 5 - 3000K 9 - 4000K
■	S - 18° M - 24° L - 37° K - 61° W - 20°x72° D - diffuse

2469 lm (3000K, CRI 80)

1988 lm (3000K, 18°, CRI 80)

1 COB LED
2-step MacAdam, 60000h L90 B10 (Ta 25°C)

body in thermally conductive plastic
screen in grey-serigraphed and transparent,
tempered extra-clear glass
trim in stainless steel

included and wired

includes 0.50 m neoprene cable
H07RN-F 2x1.0 Ø8.0 mm

recessed (ceiling)

UGR < 19 for 18°, 24° and 37° optics
Trim in magnetic stainless steel for an aesthetic
with no visible screws

Casambi-compatible version, controllable with the Casambi
app, available on request

see p. 780

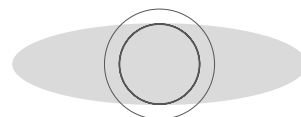

20°x72° optics
(Altopiano 3.0)

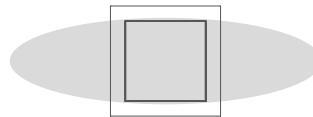

20°x72° optics
(Altopiano 3.1)



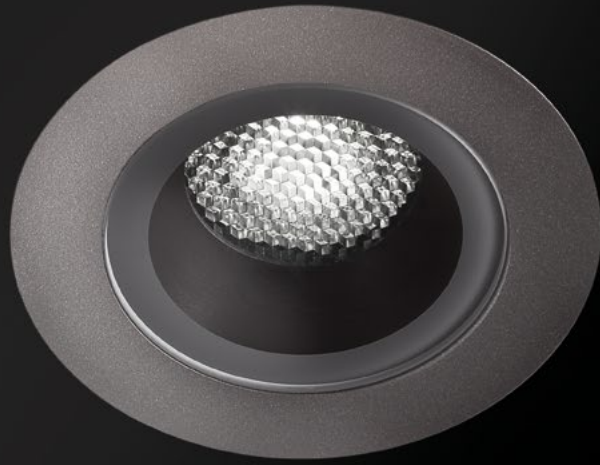

ACCESSORIES

ACCESSORIES FOR INSTALLATION

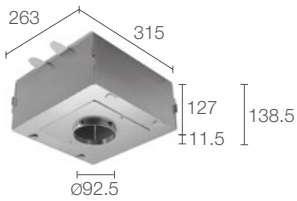

WCA19
Outer casing for solid walls
(Altopiano 1.0)

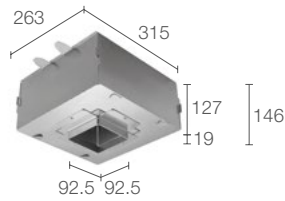

WCA22
Outer casing for solid walls
(Altopiano 1.1)

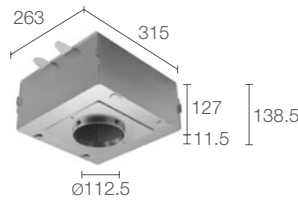

WCA18
Outer casing for solid walls
(Altopiano 2.0)

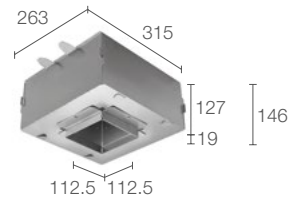

WCA21
Outer casing for solid walls
(Altopiano 2.1)

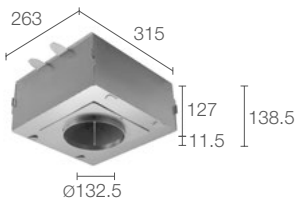

WCA17
Outer casing for solid walls
(Altopiano 3.0)

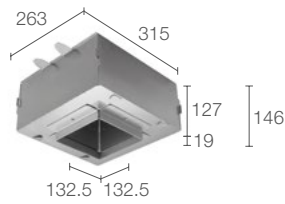

WCA20
Outer casing for solid walls
(Altopiano 3.1)



WGA02
Fixing springs for installation
(Altopiano 1 / 2)



WGA03
Fixing springs for installation
(Altopiano 3)



WNAP10A0
Anti-fall kit



WFA06
Two-pin male-female
IP66-IP68 connector



OUTDOOR RECESSED UPLIGHTS ARCHITECTURAL LIGHTING

2700K 3000K 4000K

Ø54 mm

UP TO 2 m

FIXED OPTICS

TILTABLE OPTICS

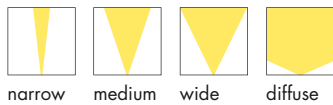

SMOOTHY 1.0 p. 83
constant current
max 2W max 700mA

SMOOTHY 1.6 p. 83
constant voltage
2.5W/3.5W 24Vdc

Ø84 mm

UP TO 4 m

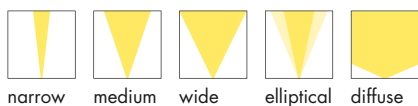

SMOOTHY 2.4 p. 84
white light: constant voltage
3.5W/5W/7W 24Vdc
RGB light: constant current
max 7W max 700mA



SMOOTHY 2.8 p. 85
constant voltage
2.5W/3.5W 24Vdc

Ø109 mm

UP TO 7 m

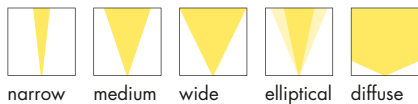

SMOOTHY 5.4 p. 86
constant voltage
10W/13W 24Vdc



SMOOTHY 5.6 p. 87
white light: constant voltage
3.5W/5W/7W 24Vdc
RGB light: constant current
max 7W max 700mA



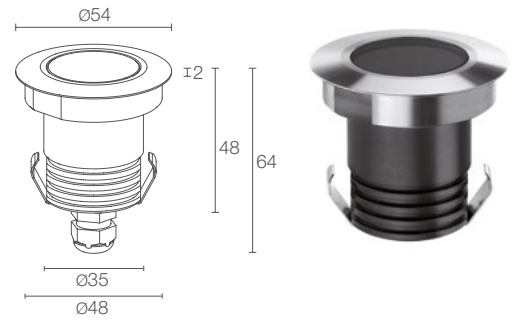
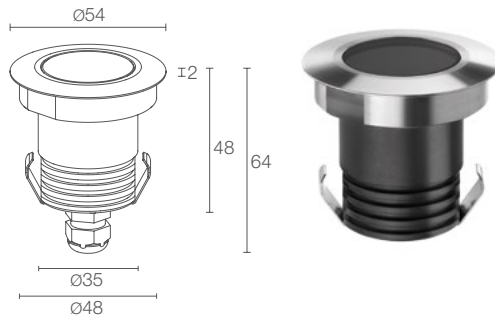

SMOOTHY 1.0

Ø 180 mm
H 110 mm

Ø 48 mm



kg 1000
KN 10

kg 0.27 IP67 IK08

A+ A++ A+++



CASAMBI T max 50°C

POWER / POWER SUPPLY CODE

max 2W max 700mA

SY1012

SMOOTHY 1.6

Ø 180 mm
H 110 mm

Ø 48 mm



kg 1000
KN 10

kg 0.27 IP67 IK08

A+ A++ A+++



CASAMBI T max 50°C

2.5W 24Vdc

SY1600

3.5W 24Vdc

SY1601

CRI	0 - CRI 80 1 - CRI >90
LED COLOUR	F - 2700K 5 - 3000K 9 - 4000K
OPTICS	S - 13° M - 22° F - 30° P - 35° sharp L - 48° D - diffuse
POWER CABLES	includes 1.5 m neoprene cable H05RN-F 2x0.75/0.75 Ø6.3 mm 1 - 5 m 2 - 10 m 3 - 15 m 4 - 20 m

CRI	0 - CRI 80 1 - CRI >90
LED COLOUR	F - 2700K 5 - 3000K 9 - 4000K
OPTICS	S - 13° M - 22° F - 30° P - 35° sharp L - 48° D - diffuse
POWER CABLES	includes 1.5 m neoprene cable H05RN-F 2x0.75/0.75 Ø6.3 mm 1 - 5 m 2 - 10 m 3 - 15 m 4 - 20 m

LUMEN OUTPUT AT SOURCE	224 lm (3000K, 700mA, CRI 80)
DELIVERED LUMEN OUTPUT	188 lm (3000K, 700mA, 22°, CRI 80)
NO. AND TYPE OF LED	1 power LED 1/4 ANSI BIN, 50000h L90 B10 (Ta 25°C)
MATERIAL	body in black-anodized anticorrosion aluminium trim in AISI 316L stainless steel screen in transparent, tempered extra-clear glass (optics version) screen in acid-etched, tempered extra-clear glass (diffuse version)
POWER SUPPLY UNIT	not included, see p. 904
WIRING	series
MOUNTING	recessed (ceiling, wall, ground)
ACCESSORIES	see p. 88
NOTES	certified ETL version available on request
PHOTOMETRIC DATA	see p. 878

LUMEN OUTPUT AT SOURCE	224 lm (3000K, 3.5W, CRI 80)
DELIVERED LUMEN OUTPUT	188 lm (3000K, 22°, 3.5W, CRI 80)
NO. AND TYPE OF LED	1 power LED 1/4 ANSI BIN, 50000h L90 B10 (Ta 25°C)
MATERIAL	body in black-anodized anticorrosion aluminium trim in AISI 316L stainless steel screen in transparent, tempered extra-clear glass (optics version) screen in acid-etched, tempered extra-clear glass (diffuse version)
POWER SUPPLY UNIT	not included, see p. 904
WIRING	parallel
MOUNTING	recessed (ceiling, wall, ground)
ACCESSORIES	see p. 88
NOTES	certified ETL version available on request
PHOTOMETRIC DATA	see p. 878

< **SMOOTHY 2.4**
3000K, 7W, 13°x52°
BRIGHT 1.A
3000K, 2W, 1°x180°

Project by / arch. Paolo Omodei Salé
Photo by / Tommy Ijai
S. Andrea pharmacy, Vicenza, Italy

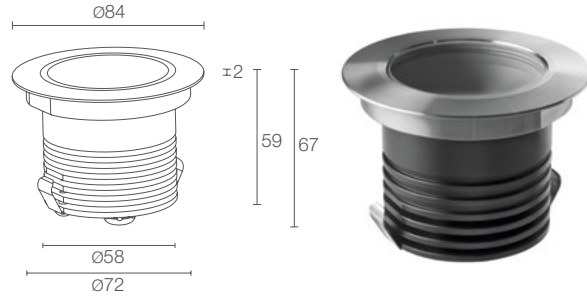

SMOOTHY 2.4

 Ø 180 mm
 H 120 mm
  Ø 75 mm

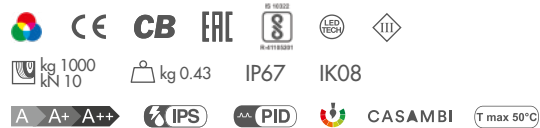

POWER SUPPLY CODE

24Vdc white light
SY240 ■ ■ ■ ■ ■ I - ■
 max 7W max 700mA RGB light
SY2432 6 ■ ■ I - ■

POWER	0 - 3.5W only 5° optics (4000K only CRI 80) 1 - 5W 2 - 7W
CRI	0 - CRI 80 1 - CRI >90
LED COLOUR	F - 2700K 5 - 3000K 9 - 4000K
OPTICS	U - 5° only 3.5W (4000K only CRI 80) RGB: V - 8° S - 20° T - 11° M - 34° S - 17° L - 45° P - 21° sharp W - 21°x42° M - 34° L - 45° Q - 61° sharp W - 13°x52° D - diffuse
POWER CABLES	includes 1.5 m neoprene cable H05RN-F 2x0.75/0.75 Ø6.3 mm RGB: includes 1.5 m FEP+RUB cable (equivalent to H05RN-F) 6x0.50/0.50 Ø6.3 mm 1 - 5 m 2 - 10 m 3 - 15 m 4 - 20 m

LUMEN OUTPUT AT SOURCE	488 lm (3000K, 5W, CRI 80) 657 lm (3000K, 7W, CRI 80) RGB: 311 lm, R: 108 lm G: 133 lm B: 70 lm (700mA)
DELIVERED LUMEN OUTPUT	352 lm (3000K, 34°, 5W, CRI 80) 463 lm (3000K, 34°, 7W, CRI 80) RGB: 253 lm, R: 98 lm G: 114 lm B: 41 lm (700mA, 34°)
NO. AND TYPE OF LED	1 high-intensity power LED, 3-step MacAdam RGB: 3 power LEDs 50000h L90 B10 (Ta 25°C)
MATERIAL	body in black-anodized anticorodal aluminium trim in AISI 316L stainless steel screen in transparent, tempered extra-clear glass (optics version) screen in acid-etched, tempered extra-clear glass (diffuse version)
POWER SUPPLY UNIT	not included, see p. 904 and 917
WIRING	parallel RGB: series
MOUNTING	recessed (ceiling, wall, ground)
ACCESSORIES	see p. 88
PHOTOMETRIC DATA	see p. 879

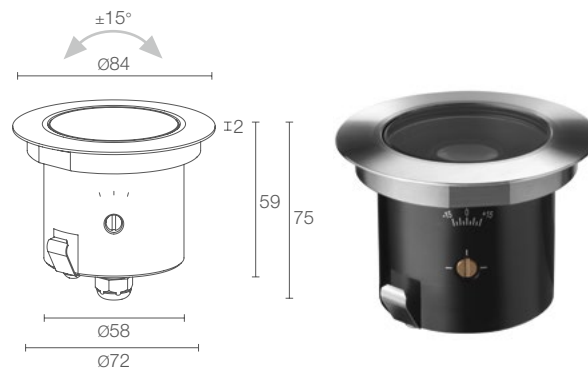

SMOOTHY 2.8

Ø 180 mm
H 120 mm

Ø 75 mm

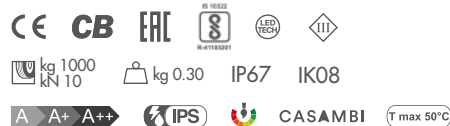

POWER / POWER SUPPLY CODE

2.5W 24Vdc
SY2800 ■ ■ ■ I - ■

3.5W 24Vdc
SY2801 ■ ■ ■ I - ■

■ CRI	0 - CRI 80 1 - CRI >90
■ LED COLOUR	F - 2700K 5 - 3000K 9 - 4000K
■ OPTICS	S - 13° tiltable ±15° M - 22° tiltable ±15° F - 30° tiltable ±15° P - 35° sharp tiltable ±15° L - 48° tiltable ±15°
■ POWER CABLES	includes 1.5 m neoprene cable H05RN-F 2x0.75/0.75 Ø6.3 mm 1 - 5 m 2 - 10 m 3 - 15 m 4 - 20 m

LUMEN OUTPUT AT SOURCE	224 lm (3000K, 3.5W, CRI 80)
DELIVERED LUMEN OUTPUT	188 lm (3000K, 22°, 3.5W, CRI 80)
NO. AND TYPE OF LED	1 power LED 1/4 ANSI BIN, 50000h L90 B10 (T _a 25°C)
MATERIAL	body in black-anodized anticorrosion aluminium trim in AISI 316L stainless steel screen in transparent, tempered extra-clear glass
POWER SUPPLY UNIT	not included, see p. 904
MOUNTING	recessed (ceiling, wall, ground)
ACCESSORIES	see p. 88
NOTES	version with honeycomb louvre and version certified ETL available on request
PHOTOMETRIC DATA	see p. 878

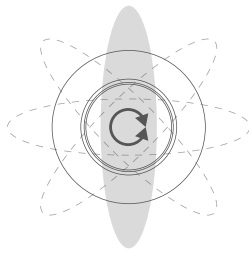

Adjustable 16°x69° optics

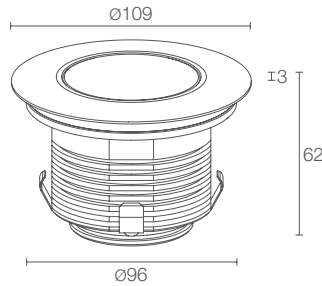

SMOOTHY 5.4

Ø 220 mm
H 150 mm

Ø 100 mm

CE CB ENEC LED TECH III kg 0.89 IP67 IK08
A A+ A++ IPS CASAMBI T max 50°C



elliptical optics,
adjusted manually
with magnet

POWER / POWER SUPPLY CODE

10W 24Vdc
SY5400 ■ ■ ■ I - ■

13W 24Vdc
SY5401 ■ ■ ■ I - ■

■ CRI	0 - CRI 80 1 - CRI >90
■ LED COLOUR	F - 2700K 5 - 3000K 9 - 4000K
■ OPTICS	S - 16° M - 21° L - 38° P - 58° sharp K - 55° W - 16°x69° adjustable D - diffuse 8° (only 10W) on request
■ POWER CABLES	includes 1.5 m neoprene cable H05RN-F 2x0.75/0.75 Ø6.3 mm 1 - 5 m 2 - 10 m 3 - 15 m 4 - 20 m

LUMEN OUTPUT AT SOURCE	1115 lm (3000K, 10W, CRI 80) 1485 lm (3000K, 13W, CRI 80)
DELIVERED LUMEN OUTPUT	800 lm (3000K, 38°, 10W, CRI 80) 1065 lm (3000K, 38°, 13W, CRI 80)
NO. AND TYPE OF LED	1 high power density COB LED 2-step MacAdam, 50000h L95 B10 (Ta 25°C)
MATERIAL	body in black-anodized anticorodal aluminium trim in AISI 316L stainless steel screen in transparent, tempered extra-clear glass (optics version) screen in acid-etched, tempered extra-clear glass (diffuse version)
POWER SUPPLY UNIT	not included, see p. 904
MOUNTING	recessed (ceiling, wall, ground)
ACCESSORIES	see p. 88
FEATURES	16°x69° optics adjustable through 360° using the magnet provided
PHOTOMETRIC DATA	see p. 880

**ANTI-GLARE
ACCESSORIES**



WH0100 (Smoothy 1.0 / 1.6)

WH0203 (Smoothy 2.4)

WH0206 (Smoothy 5.4)

WH0205 (Smoothy 5.6)

Honeycomb louvre
built into the lighting fixture

order together with
the lighting fixture

the honeycomb louvre can be fitted:
_ on all optics except for sharp, diffuse
and 16°x69° adjustable optics

_ on 5° and 8° optics on request



WE0700S (Smoothy 1.0 / 1.6)

WE0701S (Smoothy 2.4 / 2.8)

WE0702S (Smoothy 5.4 / 5.6)

Anti-glare screen,
half transparent and half serigraphed black
built into the lighting fixture

order together with
the lighting fixture

the anti-glare screen can be fitted
on the versions with white LED colour
and on all optics except for
48° and diffuse optics

∨

SMOOTHY 5.4

with anti-glare screen



ACCESSORIES

ACCESSORIES
FOR INSTALLATION**WC4010**

Outer casing
(Smoothy 1.0 / 1.6)

**WC4020**

Outer casing
(Smoothy 2.4 / 2.8)

**WC4050**

Outer casing
(Smoothy 5.4 / 5.6)

**WG0501**

Fixing springs for installation $\varnothing 48$ mm
(Smoothy 1.0 / 1.6)

**WG0502**

Fixing springs for installation $\varnothing 75$ mm
(Smoothy 2.4 / 2.8)

**WG0505**

Fixing springs for installation $\varnothing 100$ mm
(Smoothy 5.4 / 5.6)

**WL0100**

Suction cup
(Smoothy 1.0 / 1.6 / 2.4 / 2.8)

**WL0500**

Suction cup
(Smoothy 5.4 / 5.6)

for spare parts, see p. 932

ORIENTATION LIGHTING

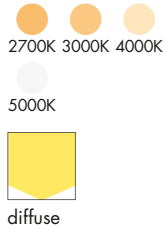

diffuse

ARCHITECTURAL LIGHTING

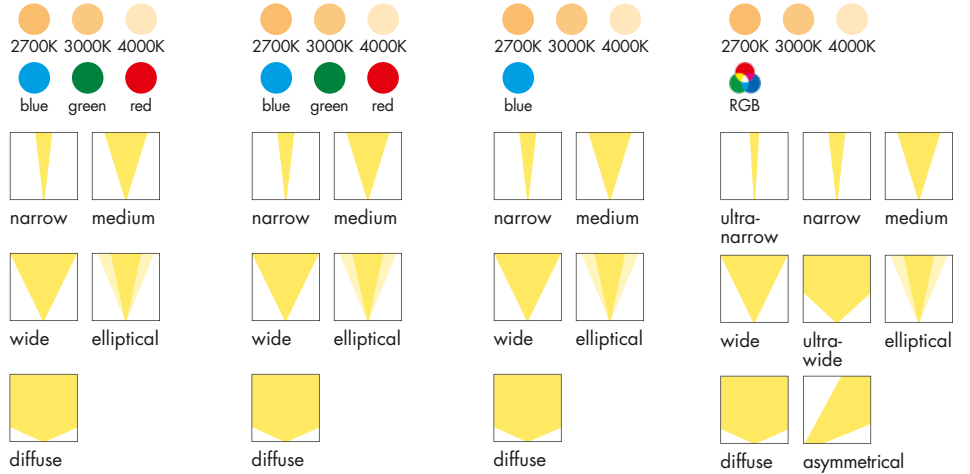

ROUND COVER

FIXED OPTICS
Ø35 mm



BRIGHT MINI 1.0
p. 93
constant voltage
0.5W 12Vac
0.6W 12Vdc
1.2W 24Vdc



UP TO 2 m



UP TO 4 m

FIXED OPTICS
Ø35 mm



BRIGHT 1.0
p. 94
constant current
max 2W max 500mA

FIXED OPTICS
Ø35 mm



BRIGHT 1.2
p. 95
constant current
max 2W max 500mA
mounted on a board

FIXED OPTICS
Ø35 mm



BRIGHT 1.6
p. 97
constant voltage
2W 24Vdc

FIXED OPTICS
Ø85 mm



BRIGHT 2.4
p. 98
white light: constant voltage
5W/7W 24Vdc
RGB light: constant current
max 5W max 500mA

SQUARE COVER

FIXED OPTICS
35x35 mm



BRIGHT MINI 1.1
p. 93
constant voltage
0.5W 12Vac
0.6W 12Vdc
1.2W 24Vdc

FIXED OPTICS
35x35 mm



BRIGHT 1.1
p. 95
constant current
max 2W max 500mA

FIXED OPTICS
35x35 mm



BRIGHT 1.7
p. 97
constant voltage
2W 24Vdc

FIXED OPTICS
85x85 mm



BRIGHT 2.5
p. 99
white light: constant voltage
5W/7W 24Vdc
RGB light: constant current
max 5W max 500mA

BRIGHT

OUTDOOR RECESSED ARCHITECTURAL AND ORIENTATION LIGHTING



TILTABLE OPTICS Ø85 mm	FIXED OPTICS Ø112 mm	TILTABLE OPTICS Ø112 mm	FIXED OPTICS Ø112 mm	FIXED OPTICS Ø148 mm	TILTABLE OPTICS Ø148 mm	FIXED OPTICS Ø148 mm
BRIGHT 2.8 p. 101 constant voltage 2.5W/3.5W 24Vdc	BRIGHT 3.F p. 102 constant voltage 10W/13W 24Vdc	BRIGHT 3.G p. 103 constant voltage 5W/9W 24Vdc	BRIGHT 3.H p. 103 constant voltage 11W 24Vdc	BRIGHT 5.F p. 104 constant voltage 14W/19W 24Vdc	BRIGHT 5.G p. 105 constant voltage 10W/16W 24Vdc	BRIGHT 5.H p. 105 constant voltage 20W 24Vdc

TILTABLE OPTICS 85x85 mm
BRIGHT 2.9 p. 101 constant voltage 2.5W/3.5W 24Vdc



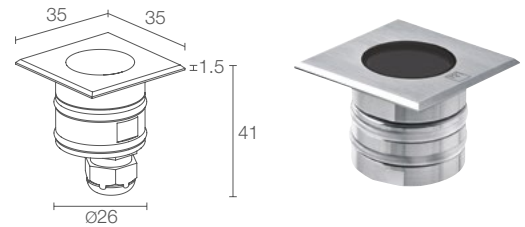
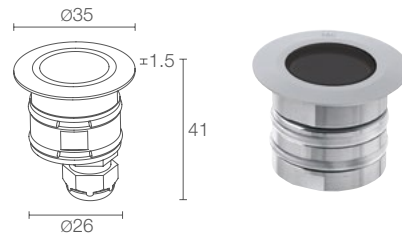

BRIGHT MINI 1.0

Ø 80 mm
H 100 mm

Ø 30 mm



kg 0.145 IP65 IP68 IK10

A A+ A++



CASAMBI

T max 45°C

POWER / POWER SUPPLY CODE 0.5W 12Vac 0.6W 12Vdc 1.2W 24Vdc
MB1000 ■ **D I**

LED COLOUR

F - 2700K
5 - 3000K
9 - 4000K
0 - 5000K

OPTICS

diffuse

LUMEN OUTPUT AT SOURCE	41 lm (3000K, 24Vdc)
DELIVERED LUMEN OUTPUT	20 lm (3000K, 24Vdc)
NO. AND TYPE OF LED	1 mid-power LED 1/4 ANSI BIN, 50000h L90 B10 (Ta 25°C)
MATERIAL	body and trim in AISI 316L stainless steel screen in tempered, acid-etched glass
POWER SUPPLY UNIT	not included, see p. 904
POWER CABLES	includes 1.5 m neoprene cable 05RN-F 2x0.35 Ø4.3 mm
MOUNTING	recessed (ceiling, wall, ground) thickness: min 3 mm, max 30 mm
ACCESSORIES	see p. 108
NOTES	not suitable for use in swimming pools or fountains underwater version: Bright 1.0 316L, p. 730 certified ETL version available on request
PHOTOMETRIC DATA	see p. 796

BRIGHT MINI 1.1

Ø 80 mm
H 100 mm

Ø 30 mm



kg 0.145 IP65 IP68 IK10

A A+ A++



CASAMBI

T max 45°C

POWER / POWER SUPPLY CODE 0.5W 12Vac 0.6W 12Vdc 1.2W 24Vdc
MB1100 ■ **D I**

F - 2700K
5 - 3000K
9 - 4000K
0 - 5000K

OPTICS

diffuse

LUMEN OUTPUT AT SOURCE	41 lm (3000K, 24Vdc)
DELIVERED LUMEN OUTPUT	20 lm (3000K, 24Vdc)
NO. AND TYPE OF LED	1 mid-power LED 1/4 ANSI BIN, 50000h L90 B10 (Ta 25°C)
MATERIAL	body and trim in AISI 316L stainless steel screen in tempered, acid-etched glass
POWER SUPPLY UNIT	not included, see p. 904
POWER CABLES	includes 1.5 m neoprene cable 05RN-F 2x0.35 Ø4.3 mm
MOUNTING	recessed (ceiling, wall, ground) thickness: min 3 mm, max 30 mm
ACCESSORIES	see p. 108
NOTES	not suitable for use in swimming pools or fountains underwater version: Bright 1.0 316L, p. 730 certified ETL version available on request
PHOTOMETRIC DATA	see p. 796

< **BRIGHT 1.6**
4000K, 2W, diffuse

Project by / SC Servizi Integrati
Torre Bassano
Torre del Greco, Naples, Italy

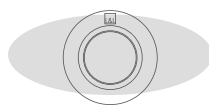

15°x38° optics
(Bright 1.0 / 1.2)

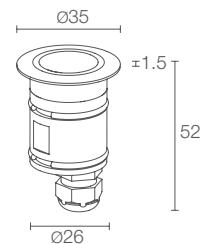

BRIGHT 1.0

Ø 80 mm
H 100 mm

Ø 30 mm

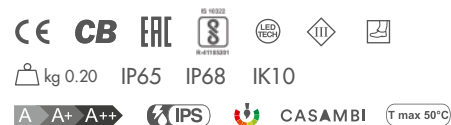

POWER / POWER SUPPLY CODE	max 2W max 500mA CB1012 ■ ■ ■ A I - ■
LED COLOUR	F - 2700K 5 - 3000K 9 - 4000K 1 - blue 2 - green 3 - red 2200K on request
OPTICS	S - 10° V - 21° sharp M - 21° L - 43° T - 54° sharp W - 15°x38° D - diffuse
POWER CABLES	includes 1.5 m neoprene cable H05RN-F 2x0.35/0.75 Ø6.3 mm 1 - 5 m 2 - 10 m 3 - 15 m 4 - 20 m

LUMEN OUTPUT AT SOURCE	195 lm (3000K, 500mA)
DELIVERED LUMEN OUTPUT	127 lm (3000K, 500mA, 21°)
NO. AND TYPE OF LED	1 power LED 2-step MacAdam (white LED colour) 60000h L90 B10 (Ta 25°C)
MATERIAL	body and trim in AISI 316L stainless steel screen in transparent, tempered extra-clear glass (optics version) screen in acid-etched, tempered glass (diffuse version)
POWER SUPPLY UNIT	not included, see p. 904
WIRING	series
MOUNTING	recessed (ceiling, wall, ground)
ACCESSORIES	see p. 108
NOTES	not suitable for use in swimming pools or fountains underwater version: Bright 1.0 316L, p. 730 24Vdc version: Bright 1.6, p. 97 certified ETL version available on request
PHOTOMETRIC DATA	see p. 796

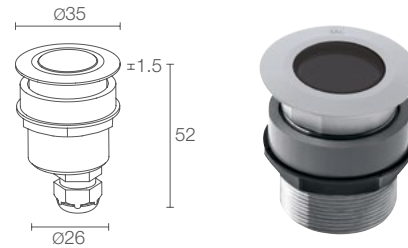
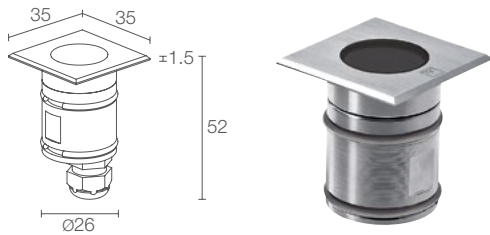

BRIGHT 1.1

Ø 80 mm
H 100 mm

Ø 30 mm



kg 0.20 IP65 IP68 IK10

A A+ A++ IPS CASAMBI T max 50°C

max 2W max 500mA

CB1112 ■ ■ ■ A I - ■

■ **F** - 2700K
5 - 3000K
9 - 4000K
1 - blue
2 - green
3 - red

2200K on request

■ **S** - 10°
M - 21°
L - 43°
D - diffuse

■ includes 1.5 m neoprene cable
H05RN-F 2x0.35/0.75 Ø6.3 mm
1 - 5 m
2 - 10 m
3 - 15 m
4 - 20 m

195 lm (3000K, 500mA)

127 lm (3000K, 500mA, 21°)

1 power LED
2-step MacAdam (white LED colour)
60000h L90 B10 (Ta 25°C)

body and trim in AISI 316L stainless steel
screen in transparent, tempered extra-clear glass
(optics version)
screen in acid-etched, tempered glass (diffuse version)

not included, see p. 904

series

recessed (ceiling, wall, ground)

see p. 108

not suitable for use in swimming pools or fountains
underwater version: Bright 1.0 316L, p. 730
24Vdc version: Bright 1.7, p. 97
certified ETL version available on request

see p. 796

BRIGHT 1.2

Ø 80 mm
H 100 mm

Ø 28 mm



kg 0.20 IP65 IP68 IK10

A A+ A++ IPS CASAMBI T max 50°C

max 2W max 500mA

CB1212 ■ ■ ■ A I - ■

■ **F** - 2700K
5 - 3000K
9 - 4000K
1 - blue
2 - green
3 - red

■ **S** - 10°
M - 21°
L - 43°
W - 15°x38°
D - diffuse

■ includes 1.5 m neoprene cable
H05RN-F 2x0.35/0.75 Ø6.3 mm
1 - 5 m
2 - 10 m
3 - 15 m
4 - 20 m

195 lm (3000K, 500mA)

127 lm (3000K, 500mA, 21°)

1 power LED
2-step MacAdam (white LED colour)
60000h L90 B10 (Ta 25°C)

body and trim in AISI 316L stainless steel
screen in transparent, tempered extra-clear glass
(optics version)
screen in acid-etched, tempered glass (diffuse version)

not included, see p. 904

series

recessed on a board (thickness: min 0 mm, max 30 mm)

see p. 108

not suitable for use in swimming pools or fountains
underwater version: Bright 1.0 316L, p. 730
certified ETL version available on request

see p. 796



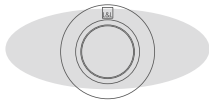

15°x38° optics
(Bright 1.6)

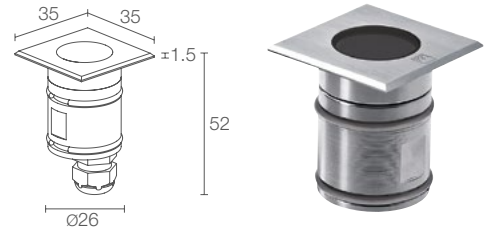
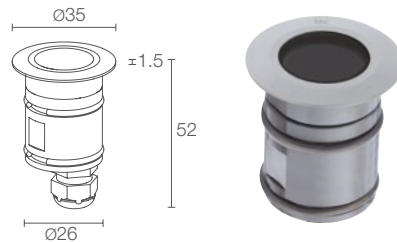

BRIGHT 1.6

Ø 80 mm H 100 mm Ø 30 mm



kg 0.20 IP65 IP68 IK10

A A+ A++ IPS CASAMBI T max 50°C

POWER / POWER SUPPLY CODE	2W 24Vdc CB1600 ■ ■ I - ■
LED COLOUR	F - 2700K 5 - 3000K 9 - 4000K 1 - blue
OPTICS	S - 10° V - 21° sharp M - 21° L - 43° T - 54° sharp W - 15°x38° D - diffuse
POWER CABLES	includes 1.5 m neoprene cable H05RN-F 2x0.35/0.75 Ø6.3 mm 1 - 5 m 2 - 10 m 3 - 15 m 4 - 20 m

LUMEN OUTPUT AT SOURCE	195 lm (3000K)
DELIVERED LUMEN OUTPUT	127 lm (3000K, 21°)
NO. AND TYPE OF LED	1 power LED 2-step MacAdam (white LED colour) 60000h L90 B10 (Ta 25°C)
MATERIAL	body and trim in AISI 316L stainless steel screen in transparent, tempered extra-clear glass (optics version) screen in acid-etched, tempered glass (diffuse version)
POWER SUPPLY UNIT	not included, see p. 904
MOUNTING	recessed (ceiling, wall, ground)
ACCESSORIES	see p. 108
NOTES	not suitable for use in swimming pools or fountains underwater version: Bright 1.6 316L, p. 731 500mA version: Bright 1.0, p. 94 certified ETL version available on request
PHOTOMETRIC DATA	see p. 796

BRIGHT 1.7

Ø 80 mm H 100 mm Ø 30 mm



kg 0.20 IP65 IP68 IK10

A A+ A++ IPS CASAMBI T max 50°C

POWER / POWER SUPPLY CODE	2W 24Vdc CB1700 ■ ■ I - ■
LED COLOUR	F - 2700K 5 - 3000K 9 - 4000K 1 - blue
OPTICS	S - 10° M - 21° L - 43° D - diffuse
POWER CABLES	includes 1.5 m neoprene cable H05RN-F 2x0.35/0.75 Ø6.3 mm 1 - 5 m 2 - 10 m 3 - 15 m 4 - 20 m

LUMEN OUTPUT AT SOURCE	195 lm (3000K)
DELIVERED LUMEN OUTPUT	127 lm (3000K, 21°)
NO. AND TYPE OF LED	1 power LED 2-step MacAdam (white LED colour) 60000h L90 B10 (Ta 25°C)
MATERIAL	body and trim in AISI 316L stainless steel screen in transparent, tempered extra-clear glass (optics version) screen in acid-etched, tempered glass (diffuse version)
POWER SUPPLY UNIT	not included, see p. 904
MOUNTING	recessed (ceiling, wall, ground)
ACCESSORIES	see p. 108
NOTES	not suitable for use in swimming pools or fountains underwater version: Bright 1.6 316L, p. 731 500mA version: Bright 1.1, p. 95 certified ETL version available on request
PHOTOMETRIC DATA	see p. 796

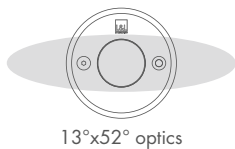

13°x52° optics



21°x42° optics

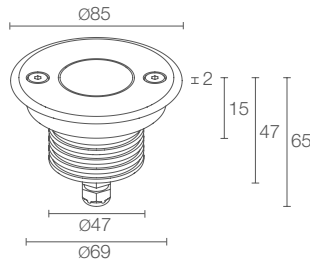

BRIGHT 2.4

Ø 180 mm
H 120 mm

Ø 70 mm



POWER / POWER SUPPLY CODE

5W 24Vdc white light

CB2400 AF - Body in aluminium, trim in grey-painted aluminium

CB2400 AI - Body in aluminium, trim in stainless steel

CB2400 II - Body in stainless steel, trim in stainless steel

7W 24Vdc white light

CB2401 AF - Body in aluminium, trim in grey-painted aluminium

CB2401 AI - Body in aluminium, trim in stainless steel

CB2401 II - Body in stainless steel, trim in stainless steel

max 5W max 500mA RGB light

CB24326 AF - Body in aluminium, trim in grey-painted aluminium

CB24326 AI - Body in aluminium, trim in stainless steel

CB24326 II - Body in stainless steel, trim in stainless steel

CRI	0 - CRI 80 1 - CRI >90																		
LED COLOUR	F - 2700K 5 - 3000K 9 - 4000K																		
OPTICS	<table border="0"> <tr> <td>Z - asymmetrical, 8°</td> <td>L - 45°</td> <td>RGB:</td> </tr> <tr> <td>V - 8°</td> <td>J - 47°</td> <td>S - 20°</td> </tr> <tr> <td>T - 11°</td> <td>Q - 61° sharp</td> <td>M - 34°</td> </tr> <tr> <td>S - 17°</td> <td>K - 68°</td> <td>L - 45°</td> </tr> <tr> <td>P - 21° sharp</td> <td>W - 13°x52°</td> <td>W - 21°x42°</td> </tr> <tr> <td>M - 34°</td> <td>D - diffuse</td> <td></td> </tr> </table> <p>5° (only white light and 3.5W) on request</p>	Z - asymmetrical, 8°	L - 45°	RGB:	V - 8°	J - 47°	S - 20°	T - 11°	Q - 61° sharp	M - 34°	S - 17°	K - 68°	L - 45°	P - 21° sharp	W - 13°x52°	W - 21°x42°	M - 34°	D - diffuse	
Z - asymmetrical, 8°	L - 45°	RGB:																	
V - 8°	J - 47°	S - 20°																	
T - 11°	Q - 61° sharp	M - 34°																	
S - 17°	K - 68°	L - 45°																	
P - 21° sharp	W - 13°x52°	W - 21°x42°																	
M - 34°	D - diffuse																		
POWER CABLES	<p>includes 1.5 m neoprene cable H05RN-F 2x0.75/0.75 Ø6.3 mm</p> <p>RGB: includes 1.5 m FEP+RUB cable (equivalent to H05RN-F) 6x0.50/0.50 Ø6.3 mm</p> <p>1 - 5 m 2 - 10 m 3 - 15 m 4 - 20 m</p>																		

LUMEN OUTPUT AT SOURCE	488 lm (3000K, 5W, CRI 80) 657 lm (3000K, 7W, CRI 80) RGB: 253 lm, R: 82 lm G: 114 lm B: 57 lm (500mA)
DELIVERED LUMEN OUTPUT	352 lm (3000K, 34°, 5W, CRI 80) 463 lm (3000K, 34°, 7W, CRI 80) RGB: 191 lm, R: 70 lm G: 90 lm B: 31 lm (500mA, 34°)
NO. AND TYPE OF LED	1 high-intensity power LED, 3-step MacAdam RGB: 3 power LEDs 50000h L90 B10 (Ta 25°C)
MATERIAL	body in black-anodized anticorrosion aluminium or AISI 316L stainless steel trim in AISI 316L stainless steel or aluminium screen in transparent, tempered extra-clear glass (optics version) screen in sandblasted, tempered extra-clear glass (diffuse version)
POWER SUPPLY UNIT	not included, see p. 904 and 917
WIRING	parallel RGB: series
MOUNTING	recessed (ceiling, wall, ground)
ACCESSORIES	see p. 108
NOTES	not suitable for use in swimming pools or fountains, underwater fixtures p. 728 version with 9W power (with white LED colour) available on request
PHOTOMETRIC DATA	see p. 797



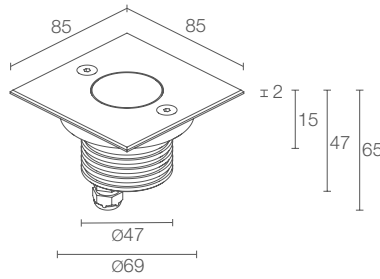
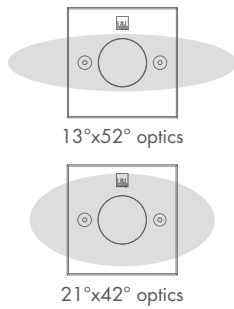

BRIGHT 2.5

Ø 180 mm H 120 mm Ø 70 mm



POWER / POWER SUPPLY CODE

5W 24Vdc white light
CB2500 AI - Body in aluminium, trim in stainless steel
CB2500 II - Body in stainless steel, trim in stainless steel
 7W 24Vdc white light
CB2501 AI - Body in aluminium, trim in stainless steel
CB2501 II - Body in stainless steel, trim in stainless steel
 max 5W max 500mA RGB light
CB25326 AI - Body in aluminium, trim in stainless steel
CB25326 II - Body in stainless steel, trim in stainless steel

CRI	0 - CRI 80 1 - CRI >90																		
LED COLOUR	F - 2700K 5 - 3000K 9 - 4000K																		
OPTICS	<table border="0"> <tr> <td>Z - asymmetrical, 8°</td> <td>L - 45°</td> <td>RGB:</td> </tr> <tr> <td>V - 8°</td> <td>J - 47°</td> <td>S - 20°</td> </tr> <tr> <td>T - 11°</td> <td>Q - 61° sharp</td> <td>M - 34°</td> </tr> <tr> <td>S - 17°</td> <td>K - 68°</td> <td>L - 45°</td> </tr> <tr> <td>P - 21° sharp</td> <td>W - 13°x52°</td> <td>W - 21°x42°</td> </tr> <tr> <td>M - 34°</td> <td>D - diffuse</td> <td></td> </tr> </table> <p>5° (only white light and 3.5W) on request</p>	Z - asymmetrical, 8°	L - 45°	RGB:	V - 8°	J - 47°	S - 20°	T - 11°	Q - 61° sharp	M - 34°	S - 17°	K - 68°	L - 45°	P - 21° sharp	W - 13°x52°	W - 21°x42°	M - 34°	D - diffuse	
Z - asymmetrical, 8°	L - 45°	RGB:																	
V - 8°	J - 47°	S - 20°																	
T - 11°	Q - 61° sharp	M - 34°																	
S - 17°	K - 68°	L - 45°																	
P - 21° sharp	W - 13°x52°	W - 21°x42°																	
M - 34°	D - diffuse																		
POWER CABLES	includes 1.5 m neoprene cable H05RN-F 2x0.75/0.75 Ø6.3 mm RGB: includes 1.5 m FEP+RUB cable (equivalent to H05RN-F) 6x0.50/0.50 Ø6.3 mm 1 - 5 m 2 - 10 m 3 - 15 m 4 - 20 m																		

LUMEN OUTPUT AT SOURCE	488 lm (3000K, 5W, CRI 80) 657 lm (3000K, 7W, CRI 80) RGB: 253 lm, R: 82 lm G: 114 lm B: 57 lm (500mA)
DELIVERED LUMEN OUTPUT	352 lm (3000K, 34°, 5W, CRI 80) 463 lm (3000K, 34°, 7W, CRI 80) RGB: 191 lm, R: 70 lm G: 90 lm B: 31 lm (500mA, 34°)
NO. AND TYPE OF LED	1 high-intensity power LED, 3-step MacAdam RGB: 3 power LEDs 50000h L90 B10 (Ta 25°C)
MATERIAL	body in black-anodized anticorrosion aluminium or AISI 316L stainless steel trim in AISI 316L stainless steel screen in transparent, tempered extra-clear glass (optics version) screen in sandblasted, tempered extra-clear glass (diffuse version)
POWER SUPPLY UNIT	not included, see p. 904 and 917
WIRING	parallel RGB: series
MOUNTING	recessed (ceiling, wall, ground)
ACCESSORIES	see p. 108
NOTES	not suitable for use in swimming pools or fountains, underwater fixtures p. 728 version with 9W power (with white LED colour) available on request
PHOTOMETRIC DATA	see p. 797





BRIGHT 2

OUTDOOR RECESSED

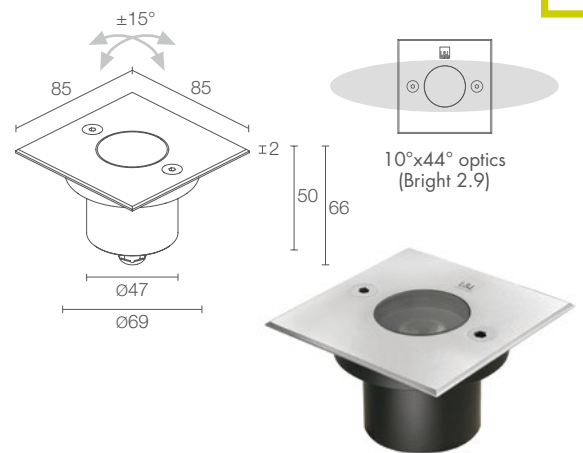
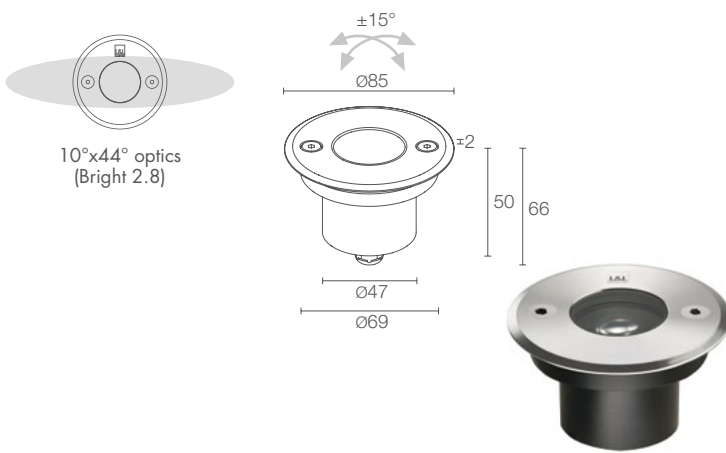

BRIGHT 2.8

Ø 180 mm H 120 mm Ø 70 mm

CE CB ENEC LED TECH II kg 2000 kN 20
 kg 0.40 steel IP65 IP68 IP69K IK10
 A A+ A++ IPS CASAMBI T max 55°C

POWER / POWER SUPPLY CODE

2.5W 24Vdc
CB28000 I - Stainless steel
CB28000 F - Grey
 3.5W 24Vdc
CB28010 I - Stainless steel
CB28010 F - Grey

LED COLOUR	F - 2700K 5 - 3000K 9 - 4000K 1 - blue 2200K on request
OPTICS	S - 8° tiltable ±15° M - 20° tiltable ±15° P - 36° sharp tiltable ±15° L - 41° tiltable ±15° Q - 68° sharp tiltable ±15° W - 10°x44° tiltable ±15°
POWER CABLES	includes 1.5 m neoprene cable H05RN-F 2x0.75/0.75 Ø6.3 mm 1 - 5 m 2 - 10 m 3 - 15 m 4 - 20 m

BRIGHT 2.9

Ø 180 mm H 120 mm Ø 70 mm

CE CB ENEC LED TECH II kg 2000 kN 20
 kg 0.50 IP65 IP68 IP69K IK10
 A A+ A++ IPS CASAMBI T max 55°C

2.5W 24Vdc
CB29000 I - Stainless steel
CB29000 F - Grey
 3.5W 24Vdc
CB29010 I - Stainless steel
CB29010 F - Grey

LED COLOUR	F - 2700K 5 - 3000K 9 - 4000K 1 - blue 2200K on request
OPTICS	S - 8° tiltable ±15° M - 20° tiltable ±15° P - 36° sharp tiltable ±15° L - 41° tiltable ±15° Q - 68° sharp tiltable ±15° W - 10°x44° tiltable ±15°
POWER CABLES	includes 1.5 m neoprene cable H05RN-F 2x0.75/0.75 Ø6.3 mm 1 - 5 m 2 - 10 m 3 - 15 m 4 - 20 m

LUMEN OUTPUT AT SOURCE	184 lm (3000K, 3.5W)
DELIVERED LUMEN OUTPUT	143 lm (3000K, 20°, 3.5W)
NO. AND TYPE OF LED	1 power LED 1/4 ANSI BIN (white LED colour) 50000h L90 B10 (Ta 25°C)
MATERIAL	body in black-anodized anticorrosion aluminium trim in AISI 316L stainless steel or aluminium screen in transparent, tempered extra-clear glass
POWER SUPPLY UNIT	not included, see p. 904
MOUNTING	recessed (ceiling, wall, ground)
ACCESSORIES	see p. 108
NOTES	not suitable for use in swimming pools or fountains underwater fixtures p. 728 version with honeycomb louvre available on request
PHOTOMETRIC DATA	see p. 798

LUMEN OUTPUT AT SOURCE	184 lm (3000K, 3.5W)
DELIVERED LUMEN OUTPUT	143 lm (3000K, 20°, 3.5W)
NO. AND TYPE OF LED	1 power LED 1/4 ANSI BIN (white LED colour) 50000h L90 B10 (Ta 25°C)
MATERIAL	body in black-anodized anticorrosion aluminium trim in AISI 316L stainless steel screen in transparent, tempered extra-clear glass
POWER SUPPLY UNIT	not included, see p. 904
MOUNTING	recessed (ceiling, wall, ground)
ACCESSORIES	see p. 108
NOTES	not suitable for use in swimming pools or fountains underwater fixtures p. 728 version with honeycomb louvre available on request
PHOTOMETRIC DATA	see p. 798

< **BRIGHT 2.8**
3000K, 3.5W, 20° - 41°, stainless steel

Project by / Studio DELBOCA + Partners,
Studio Architetti, Simona e Giovanni Rossi
Light planning by / Rada Markovic Lighting Design Studio
Promoter / Client / Contractor: Montanari Costruzioni s.r.l.
Casa sul Parco, Fidenza, Parma, Italy



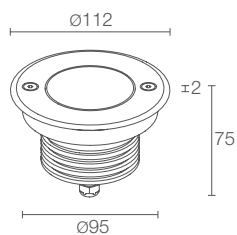

BRIGHT 3.F

Ø 220 mm
H 150 mm

Ø 96 mm

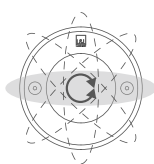

Adjustable
16°x69° optics



patented
elliptical optics,
adjusted manually
with magnet

POWER SUPPLY CODE

24Vdc diffuse
CB3FO 0200DI

24Vdc
CB3FO 0000I

POWER	0 - 10W 1 - 13W
CRI	0 - CRI 80 1 - CRI >90
OPTICAL ACCESSORIES	0 - none 1 - anti-glare screen, half transparent and half serigraphed black (not compatible with the honeycomb louvre)
HONEYCOMB LOUVRE	0 - not present 1 - present (not compatible with the anti-glare screen, or with the 58° sharp and 16°x69° adjustable optics)
LED COLOUR	F - 2700K 5 - 3000K 9 - 4000K
OPTICS	S - 16° M - 21° L - 38° K - 55° P - 58° sharp W - 16°x69° adjustable
POWER CABLES	includes 1.5 m neoprene cable H05RN-F 2x0.75/0.75 Ø6.3 mm 1 - 5 m 2 - 10 m 3 - 15 m 4 - 20 m

LUMEN OUTPUT AT SOURCE	1115 lm (3000K, 10W, CRI 80) 1485 lm (3000K, 13W, CRI 80)
DELIVERED LUMEN OUTPUT	845 lm (3000K, 55°, 10W, CRI 80) 1125 lm (3000K, 55°, 13W, CRI 80)
NO. AND TYPE OF LED	1 high power density COB LED 3-step MacAdam, 50000h L95 B10 (Ta 25°C)
MATERIAL	body in black-anodized anticorrosional aluminium trim in AISI 316L stainless steel screen in grey-serigraphed and transparent, tempered extra-clear glass (optics version) screen in acid-etched, tempered extra-clear glass (diffuse version)
POWER SUPPLY UNIT	not included, see p. 904
MOUNTING	recessed (ceiling, wall, ground)
ACCESSORIES	see p. 108
FEATURES	16°x69° optics adjustable through 360° using magnet included
NOTES	not suitable for use in swimming pools or fountains underwater fixtures p. 728
PHOTOMETRIC DATA	see p. 799

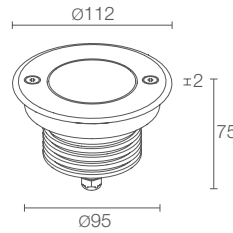
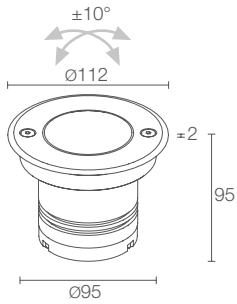

BRIGHT 3.6

Ø 220 mm H 150 mm Ø 96 mm

CE CB EAC LED TECH III kg 5000 kN 50
 kg 0.95 IP65 IP67 IP69K IK10
 A+ A++ IPS CASAMBI T max 50°C

24Vdc

CB3G0 0 1

0 - 5W 1 - 9W
0 - CRI 80 1 - CRI >90
0 - none 1 - anti-glare screen, half transparent and half serigraphed black (not compatible with the honeycomb louvre)
0 - not present 1 - present (not compatible with the anti-glare screen)
F - 2700K 5 - 3000K 9 - 4000K
S - 12° tiltable ±10° M - 20° tiltable ±10° L - 35° tiltable ±10° K - 57° tiltable ±10°
includes 1.5 m neoprene cable H05RN-F 2x0.75/0.75 Ø6.3 mm 1 - 5 m 2 - 10 m 3 - 15 m 4 - 20 m

440 lm (3000K, 5W, CRI 80)
792 lm (3000K, 9W, CRI 80)

282 lm (3000K, 35°, 5W, CRI 80)
508 lm (3000K, 35°, 9W, CRI 80)

1 high-intensity power LED
3-step MacAdam, 50000h L90 B10 (Ta 25°C)

body in black-anodized anticorrosion aluminium
trim in AISI 316L stainless steel
screen in grey-serigraphed and transparent,
tempered extra-clear glass

not included, see p. 904

recessed (ceiling, wall, ground)

see p. 108

see p. 799

BRIGHT 3.H

Ø 220 mm H 150 mm Ø 96 mm

CE CB EAC LED TECH III kg 5000 kN 50
 kg 0.80 IP68 IP69K IK10
 A+ A++ IPS CASAMBI T max 50°C

24Vdc

CB3H0000007 0 1

11W
RGBW
S - 18° M - 32° L - 58°
includes 1.5 m FEP+RUB cable (equivalent to H05RN-F) 6x0.50/0.50 Ø6.3 mm 1 - 5 m

447 lm, R: 68 lm G: 139 lm B: 51 lm W: 189 lm (4000K)

278 lm, R: 43 lm G: 87 lm B: 32 lm W: 116 lm (4000K, 18°)

1 RGBW power LED group
50000h L85 B10 (Ta 25°C)

body in black-anodized anticorrosion aluminium
trim in AISI 316L stainless steel
screen in grey-serigraphed and transparent,
tempered extra-clear glass

not included, see p. 904 and 917

recessed (ceiling, wall, ground)

see p. 108

not suitable for use in swimming pools or fountains
underwater fixtures p. 728

see p. 800

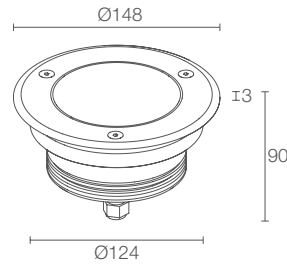

BRIGHT 5.F

Ø 260 mm H 150 mm Ø 125 mm

CE CB EAC LED TECH III kg 4000 kN 40

kg 1.35 IP65 IP68 IP69K IK10

A A+ A++ IPS PID NTC CASAMBI T max 40°C

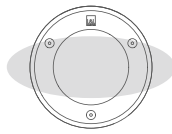

15°x47° optics



Adjustable
67°x11° optics



patented
elliptical optics,
adjusted manually
with magnet

POWER SUPPLY CODE

24Vdc

CB5FO ■■■ 00 ■■ 0 ■ I - ■

POWER

0 - 14W
1 - 19W

CRI

0 - CRI 80
1 - CRI >90

HONEYCOMB LOUVRE

0 - not present
1 - present
(not compatible with the 67°x11° adjustable optics)

LED COLOUR

F - 2700K
5 - 3000K
9 - 4000K

OPTICS

V - 10°
T - 12°
S - 18°
M - 31°
L - 35°
K - 56°
W - 15°x47°
X - 67°x11° adjustable

POWER CABLES

includes 1.5 m neoprene cable H05RN-F 2x0.75/0.75 Ø6.3 mm
1 - 5 m
2 - 10 m
3 - 15 m
4 - 20 m

LUMEN OUTPUT AT SOURCE

1131 lm (3000K, 14W, CRI 80)
1663 lm (3000K, 19W, CRI 80)

DELIVERED LUMEN OUTPUT

821 lm (3000K, 12°, 14W, CRI 80)
1208 lm (3000K, 12°, 19W, CRI 80)

NO. AND TYPE OF LED

3 high-intensity power LEDs
3-step MacAdam, 50000h L95 B10 (Ta 25°C)

MATERIAL

body in black-anodized anticorrosion aluminium
trim in AISI 316L stainless steel
screen in grey-serigraphed and transparent,
tempered extra-clear glass

POWER SUPPLY UNIT

not included, see p. 904

MOUNTING

recessed (ceiling, wall, ground)

ACCESSORIES

see p. 108

FEATURES

67°x11° optics adjustable through 360° using magnet included

NOTES

not suitable for use in swimming pools or fountains
underwater fixtures p. 728

PHOTOMETRIC DATA

see p. 800



BRIGHT 5.G

Ø 260 mm H 150 mm Ø 125 mm

CE CB ENEC LED TECH III kg 4000 kN 40
 kg 1.65 IP65 IP67 IP69K IK09
 A A+ A++ IPS CASAMBI T max 50°C

24Vdc

CB5G0 ■ ■ ■ 0 0 ■ ■ ■ 0 ■ ■ I - ■

■	0 - 10W 1 - 16W
■	0 - CRI 80 1 - CRI >90
■	0 - not present 1 - present
■	F - 2700K 5 - 3000K 9 - 4000K
■	S - 12° tiltable ±10° M - 31° tiltable ±10° L - 38° tiltable ±10° K - 55° tiltable ±10°
■	includes 1.5 m neoprene cable H05RN-F 2x0.75/0.75 Ø6.3 mm 1 - 5 m 2 - 10 m 3 - 15 m 4 - 20 m

1033 lm (3000K, 10W, CRI 80)
1564 lm (3000K, 16W, CRI 80)

816 lm (3000K, 55°, 10W, CRI 80)
1235 lm (3000K, 55°, 16W, CRI 80)

1 high power density COB LED
3-step MacAdam, 50000h L90 B10 (Ta 25°C)

body in black-anodized anticorrosion aluminium
trim in AISI 316L stainless steel
screen in grey-serigraphed and transparent,
tempered extra-clear glass

not included, see p. 904

recessed (ceiling, wall, ground)

see p. 108

see p. 801

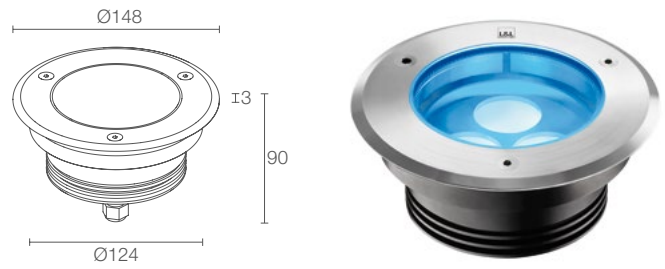

BRIGHT 5.H

Ø 260 mm H 150 mm Ø 125 mm

CE CB ENEC LED TECH III kg 4000 kN 40
 kg 1.35 IP65 IP68 IP69K IK10
 A A+ A++ IPS PID NTC CASAMBI T max 55°C

24Vdc

CB5H0000007 0 ■ ■ I - ■

	20W
	RGBW
■	S - 20° M - 34° L - 61°
■	includes 1.5 m FEP+RUB cable (equivalent to H05RN-F) 6x0.50/0.50 Ø6.3 mm 1 - 5 m

1021 lm, R: 146 lm G: 329 lm B: 117 lm W: 429 lm
(4000K)

656 lm, R: 101 lm G: 204 lm B: 75 lm W: 276 lm
(4000K, 20°)

3 RGBW power LED groups
50000h L85 B10 (Ta 25°C)

body in black-anodized anticorrosion aluminium
trim in AISI 316L stainless steel
screen grey-serigraphed and transparent,
tempered extra-clear glass

not included, see p. 904 and 917

recessed (ceiling, wall, ground)

see p. 108

not suitable for use in swimming pools or fountains
underwater fixtures p. 728

see p. 801





ANTI-GLARE ACCESSORIES



WH0101 (Bright 1.0 / 1.1 / 1.2 / 1.6 / 1.7)

WH0201 (Bright 2.4 / 2.5)

Honeycomb louvre built into the lighting fixture

order together with the lighting fixture

the honeycomb louvre can be fitted on all fixed optics except for sharp, asymmetrical 8°, 8° and diffuse optics

OPTICAL ACCESSORIES



WE0400A (Bright 2.4 / 2.5)

compatible with versions with white LED colour and with all optics except for 8° asymmetrical and diffuse optics

WE0500A (Bright 1.0 / 1.1 / 1.2 / 1.6 / 1.7)

10°, 21°, 43° optics
Semi-diffusing screen, half transparent and half frosted

built into the lighting fixture

order together with the lighting fixture



WE0400S (Bright 2.4 / 2.5 / 2.8 / 2.9)

compatible with versions with white LED colour and with all optics except for 8° asymmetrical and diffuse optics

WE0500S (Bright 1.0 / 1.1 / 1.2 / 1.6 / 1.7)

10°, 21°, 43° optics
Anti-glare screen, half transparent and half serigraphed black

built into the lighting fixture

order together with the lighting fixture

ACCESSORIES FOR INSTALLATION



WC0202

Outer casing
(Bright Mini 1.0 / 1.1
Bright 1.0 / 1.1 / 1.6 / 1.7)



WC0100

Outer casing
(Bright 2.4 / 2.5 / 2.8 / 2.9)



WC0103

Outer casing
(Bright 2.4 / 2.5 / 2.8 / 2.9)



WC0105

Outer casing
(Bright 3.F / 3.G / 3.H)



WC0150

Outer casing
(Bright 2.4 / 2.5 / 2.8 / 2.9)



WC0501

Outer casing
(Bright 5.F / 5.H)



WC0601

Outer casing
(Bright 5.F / 5.G / 5.H)



WC0701

Outer casing
(Bright 5.F / 5.G / 5.H)



WG0302

Fixing springs for installation Ø30 mm
(Bright Mini 1.0 / 1.1)



WG0301

Fixing springs for installation Ø30 mm
(Bright 1.0 / 1.1 / 1.6 / 1.7)



WG0100

Fixing springs for installation Ø70 mm
(Bright 2.4 / 2.5 / 2.8 / 2.9)



WG0400

Fixing springs for installation Ø100 mm
(Bright 3.F / 3.G / 3.H)



WG0200

Fixing springs for installation Ø130 mm
(Bright 5.F / 5.G / 5.H)

for spare parts, see p. 932

ACCESSORIES

POWER CABLES

Neoprene cables
05RN-F 2x0.35 Ø4.3 mm

WF0510

your choice of length
(Bright Mini 1.0 / 1.1)
order together with
the lighting fixture



^
LITUS 2.4
 4000K, 7W, 8°
 customized version with white-serigraphed screen

ROUND COVER
 INSTALLATION IN SOLID WALLS

2700K 3000K 4000K

Ø48 mm

UP TO 2 m

FIXED OPTICS

TILTABLE OPTICS

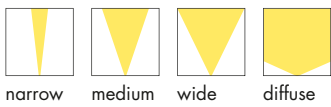

LITUS 1.0 p. 112
 constant current
 max 2W max 700mA

LITUS 1.6 p. 113
 constant voltage
 2.5W/3.5W 24Vdc

Ø72 mm

UP TO 4 m

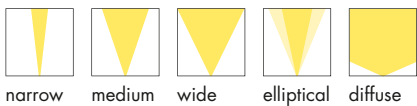

LITUS 2.4 p. 114
 white light: constant voltage
 3.5W/5W/7W 24Vdc
 RGB light: constant current
 max 7W max 700mA



LITUS 2.8 p. 116
 constant voltage
 2.5W/3.5W 24Vdc

Ø96 mm

UP TO 7 m

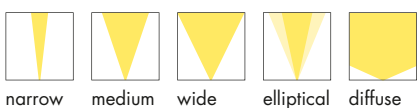

LITUS 5.4 p. 117
 constant voltage
 10W/13W 24Vdc



LITUS 5.6 p. 120
 white light: constant voltage
 3.5W/5W/7W 24Vdc
 RGB light: constant current
 max 7W max 700mA

OUTDOOR RECESSED UPLIGHTS UNOBTRUSIVE, FOR ARCHITECTURAL LIGHTING

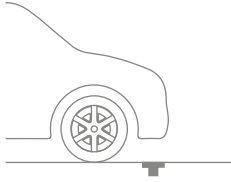

SQUARE COVER

INSTALLATION IN SOLID WALLS AND PLASTERBOARD

2700K 3000K 4000K

47x47 mm

UP TO 2 m

FIXED OPTICS

TILTABLE OPTICS

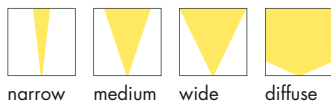

narrow medium wide diffuse



LITUS 1.1 p. 112
constant current
max 2W max 700mA

LITUS 1.7 p. 113
constant voltage
2.5W/3.5W 24Vdc

72x72 mm

UP TO 4 m



LITUS 2.5 p. 115
white light: constant voltage
3.5W/5W/7W 24Vdc
RGB light: constant current
max 7W max 700mA



LITUS 2.9 p. 116
constant voltage
2.5W/3.5W 24Vdc

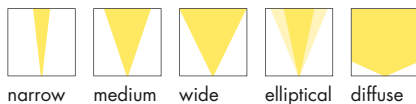

narrow medium wide elliptical diffuse



95x95 mm

UP TO 7 m



LITUS 5.5 p. 117
constant voltage
10W/13W 24Vdc



LITUS 5.7 p. 121
white light: constant voltage
3.5W/5W/7W 24Vdc
RGB light: constant current
max 7W max 700mA

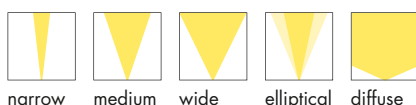

narrow medium wide elliptical diffuse



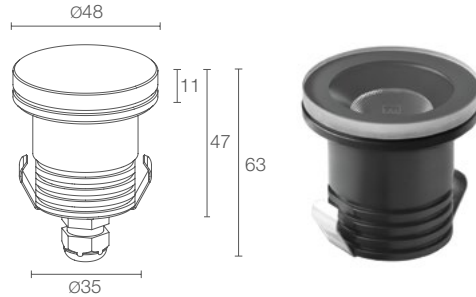
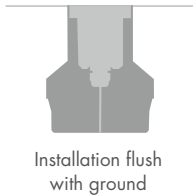

LITUS 1.0

Ø 120 mm
H 110 mm



POWER / POWER SUPPLY CODE

max 2W max 700mA
LT1010 ■ ■ ■ ■ ■ NV - ■

■ CRI	0 - CRI 80 1 - CRI >90
■ LED COLOUR	F - 2700K 5 - 3000K 9 - 4000K
■ OPTICS	S - 13° M - 22° F - 30° P - 35° sharp L - 48° D - diffuse
■ POWER CABLES	includes 1.5 m neoprene cable H05RN-F 2x0.75/0.75 Ø6.3 mm 1 - 5 m 2 - 10 m 3 - 15 m 4 - 20 m

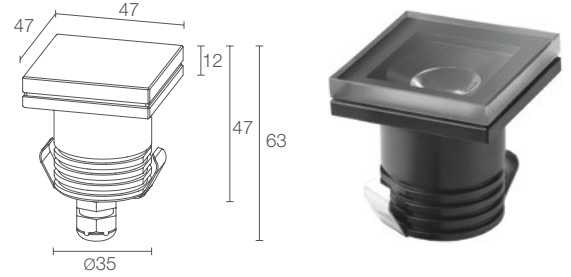

LITUS 1.1

Ø 120 mm
H 110 mm 48x48 mm



max 2W max 700mA
LT1110 ■ ■ ■ ■ ■ NV - ■

■ CRI	0 - CRI 80 1 - CRI >90
■ LED COLOUR	F - 2700K 5 - 3000K 9 - 4000K
■ OPTICS	S - 13° M - 22° F - 30° P - 35° sharp L - 48° D - diffuse
■ POWER CABLES	includes 1.5 m neoprene cable H05RN-F 2x0.75/0.75 Ø6.3 mm 1 - 5 m 2 - 10 m 3 - 15 m 4 - 20 m

LUMEN OUTPUT AT SOURCE	224 lm (3000K, 700mA, CRI 80)
DELIVERED LUMEN OUTPUT	188 lm (3000K, 700mA, 22°, CRI 80)
NO. AND TYPE OF LED	1 power LED 1/4 ANSI BIN, 50000h L90 B10 (Ta 25°C)
MATERIAL	body in black-anodized anticorrosion aluminium screen in grey-serigraphed and transparent, tempered extra-clear glass
POWER SUPPLY UNIT	not included, see p. 904
WIRING	series
MOUNTING	recessed (ceiling, wall, ground)
ACCESSORIES	see p. 122
NOTES	version with screen in white-serigraphed glass available on request
PHOTOMETRIC DATA	see p. 848

LUMEN OUTPUT AT SOURCE	224 lm (3000K, 700mA, CRI 80)
DELIVERED LUMEN OUTPUT	188 lm (3000K, 700mA, 22°, CRI 80)
NO. AND TYPE OF LED	1 power LED 1/4 ANSI BIN, 50000h L90 B10 (Ta 25°C)
MATERIAL	body in black-anodized anticorrosion aluminium screen in grey-serigraphed and transparent, tempered extra-clear glass
POWER SUPPLY UNIT	not included, see p. 904
WIRING	series
MOUNTING	recessed (ceiling, wall, ground)
ACCESSORIES	see p. 122
NOTES	version with screen in white-serigraphed glass available on request
PHOTOMETRIC DATA	see p. 848

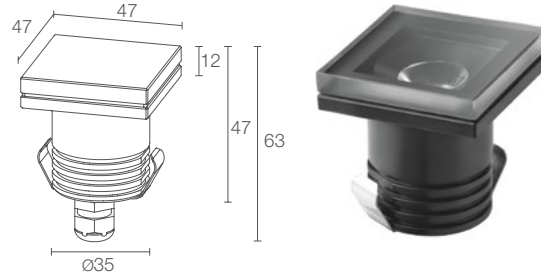
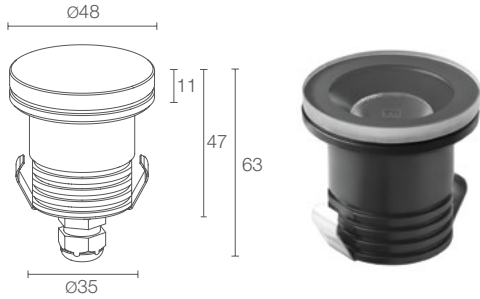

LITUS 1.6

Ø 120 mm
H 110 mm



kg 1000
kN 10

kg 0.20 IP67 IK08

A A+ A++

IPS CASAMBI T max 40°C

2.5W 24Vdc

LT1600 NV - ■

3.5W 24Vdc

LT1601 NV - ■

■ 0 - CRI 80
1 - CRI >90

■ F - 2700K
5 - 3000K
9 - 4000K

■ S - 13°
M - 22°
F - 30°
P - 35° sharp
L - 48°
D - diffuse

■ includes 1.5 m neoprene cable
H05RN-F 2x0.75/0.75 Ø6.3 mm
1 - 5 m
2 - 10 m
3 - 15 m
4 - 20 m

224 lm (3000K, 3.5W, CRI 80)

188 lm (3000K, 22°, 3.5W, CRI 80)

1 power LED
1/4 ANSI BIN, 50000h L90 B10 (Ta 25°C)

body in black-anodized anticorrosional aluminium
screen in grey-serigraphed and transparent,
tempered extra-clear glass

not included, see p. 904

parallel

recessed (ceiling, wall, ground)

see p. 122

version with screen in white-serigraphed
glass available on request

see p. 848

LITUS 1.7

Ø 120 mm
H 110 mm

48x48 mm



kg 1000
kN 10

kg 0.20 IP67 IK08

A A+ A++

IPS CASAMBI T max 40°C

2.5W 24Vdc

LT1700 NV - ■

3.5W 24Vdc

LT1701 NV - ■

■ 0 - CRI 80
1 - CRI >90

■ F - 2700K
5 - 3000K
9 - 4000K

■ S - 13°
M - 22°
F - 30°
P - 35° sharp
L - 48°
D - diffuse

■ includes 1.5 m neoprene cable
H05RN-F 2x0.75/0.75 Ø6.3 mm
1 - 5 m
2 - 10 m
3 - 15 m
4 - 20 m

224 lm (3000K, 3.5W, CRI 80)

188 lm (3000K, 22°, 3.5W, CRI 80)

1 power LED
1/4 ANSI BIN, 50000h L90 B10 (Ta 25°C)

body in black-anodized anticorrosional aluminium
screen in grey-serigraphed and transparent,
tempered extra-clear glass

not included, see p. 904

parallel

recessed (ceiling, wall, ground)

see p. 122

version with screen in white-serigraphed
glass available on request

see p. 848

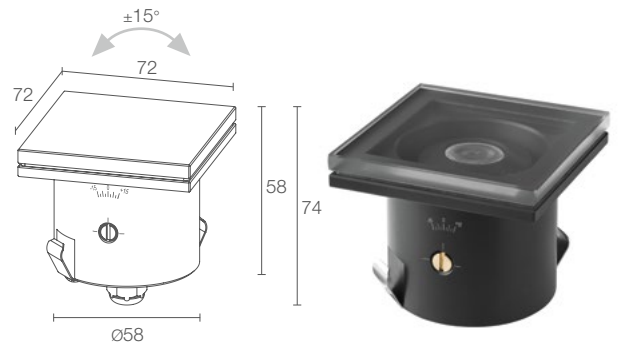
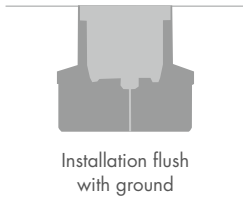

LITUS 2.8

Ø 150 mm
H 160 mm



kg 1000
kN 10

kg 0.30 IP67 IK08

A → A+ → A++

IPS CASAMBI T max 40°C

POWER / POWER SUPPLY CODE

2.5W 24Vdc
LT2800 ■ ■ ■ NV - ■

3.5W 24Vdc
LT2801 ■ ■ ■ NV - ■

■ CRI	0 - CRI 80 1 - CRI >90
■ LED COLOUR	F - 2700K 5 - 3000K 9 - 4000K
■ OPTICS	S - 13° tiltable ±15° M - 22° tiltable ±15° F - 30° tiltable ±15° P - 35° sharp tiltable ±15° L - 48° tiltable ±15°
■ POWER CABLES	includes 1.5 m neoprene cable H05RN-F 2x0.75/0.75 Ø6.3 mm 1 - 5 m 2 - 10 m 3 - 15 m 4 - 20 m

LITUS 2.9

Ø 150 mm
H 160 mm

74x74 mm



kg 1000
kN 10

kg 0.30 IP67 IK08

A → A+ → A++

IPS CASAMBI T max 40°C

2.5W 24Vdc
LT2900 ■ ■ ■ NV - ■

3.5W 24Vdc
LT2901 ■ ■ ■ NV - ■

■ CRI	0 - CRI 80 1 - CRI >90
■ LED COLOUR	F - 2700K 5 - 3000K 9 - 4000K
■ OPTICS	S - 13° tiltable ±15° M - 22° tiltable ±15° F - 30° tiltable ±15° P - 35° sharp tiltable ±15° L - 48° tiltable ±15°
■ POWER CABLES	includes 1.5 m neoprene cable H05RN-F 2x0.75/0.75 Ø6.3 mm 1 - 5 m 2 - 10 m 3 - 15 m 4 - 20 m

LUMEN OUTPUT AT SOURCE	224 lm (3000K, 3.5W, CRI 80)
DELIVERED LUMEN OUTPUT	188 lm (3000K, 22°, 3.5W, CRI 80)
NO. AND TYPE OF LED	1 power LED 1/4 ANSI BIN, 50000h L90 B10 (Ta 25°C)
MATERIAL	body in black-anodized anticorrosion aluminium screen in grey-serigraphed and transparent, tempered extra-clear glass
POWER SUPPLY UNIT	not included, see p. 904
MOUNTING	recessed (ceiling, wall, ground)
ACCESSORIES	see p. 122
NOTES	version with screen in white-serigraphed glass available on request
PHOTOMETRIC DATA	see p. 848

LUMEN OUTPUT AT SOURCE	224 lm (3000K, 3.5W, CRI 80)
DELIVERED LUMEN OUTPUT	188 lm (3000K, 22°, 3.5W, CRI 80)
NO. AND TYPE OF LED	1 power LED 1/4 ANSI BIN, 50000h L90 B10 (Ta 25°C)
MATERIAL	body in black-anodized anticorrosion aluminium screen in grey-serigraphed and transparent, tempered extra-clear glass
POWER SUPPLY UNIT	not included, see p. 904
MOUNTING	recessed (ceiling, wall, ground)
ACCESSORIES	see p. 122
NOTES	version with screen in white-serigraphed glass available on request
PHOTOMETRIC DATA	see p. 848

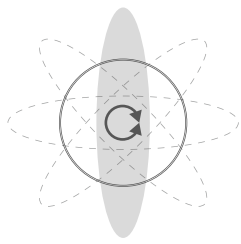

Adjustable 16°x69° optics

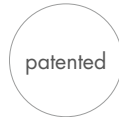
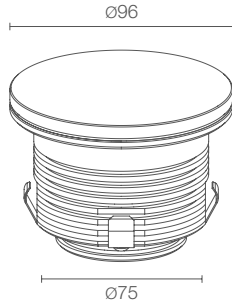

patented
elliptical optics, adjusted manually with magnet (Litus 5.4 / 5.5)

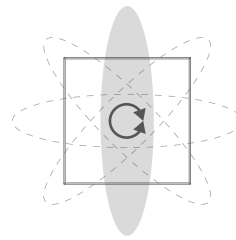

Adjustable 16°x69° optics

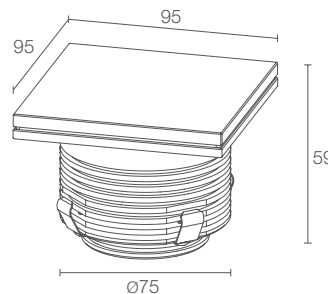

LITUS 5.4

Ø 180 mm
H 180 mm

CE CB EAC LED TECH II
kg 1000 kN 10 kg 0.60 IP67 IK08
A+ A++ IPS CASAMBI T max 40°C

LITUS 5.5

Ø 180 mm
H 180 mm 98x98 mm

CE CB EAC LED TECH III
kg 1000 kN 10 kg 0.70 IP67 IK08
A+ A++ IPS CASAMBI T max 40°C

POWER / POWER SUPPLY CODE

10W 24Vdc
LT5400 NV - ■
13W 24Vdc
LT5401 NV - ■

■ CRI	0 - CRI 80 1 - CRI >90
■ LED COLOUR	F - 2700K 5 - 3000K 9 - 4000K
■ OPTICS	S - 16° M - 21° L - 38° P - 58° sharp K - 55° W - 16°x69° adjustable D - diffuse 8° (only 10W) on request
■ POWER CABLES	includes 1.5 m neoprene cable H05RN-F 2x0.75/0.75 Ø6.3 mm 1 - 5 m 2 - 10 m 3 - 15 m 4 - 20 m

10W 24Vdc
LT5500 NV - ■
13W 24Vdc
LT5501 NV - ■

■	0 - CRI 80 1 - CRI >90
■	F - 2700K 5 - 3000K 9 - 4000K
■	S - 16° M - 21° L - 38° P - 58° sharp K - 55° W - 16°x69° adjustable D - diffuse 8° (only 10W) on request
■	includes 1.5 m neoprene cable H05RN-F 2x0.75/0.75 Ø6.3 mm 1 - 5 m 2 - 10 m 3 - 15 m 4 - 20 m

LUMEN OUTPUT AT SOURCE	1115 lm (3000K, 10W, CRI 80) 1485 lm (3000K, 13W, CRI 80)
DELIVERED LUMEN OUTPUT	800 lm (3000K, 38°, 10W, CRI 80) 1065 lm (3000K, 38°, 13W, CRI 80)
NO. AND TYPE OF LED	1 high power density COB LED 2-step MacAdam, 50000h L95 B10 (Ta 25°C)
MATERIAL	body in black-anodized anticorrosion aluminium screen in grey-serigraphed and transparent, tempered extra-clear glass
POWER SUPPLY UNIT	not included, see p. 904
MOUNTING	recessed (ceiling, wall, ground)
ACCESSORIES	see p. 122
FEATURES	16°x69° optics adjustable through 360° using the magnet provided
NOTES	version with screen in white-serigraphed glass available on request
PHOTOMETRIC DATA	see p. 850

LUMEN OUTPUT AT SOURCE	1115 lm (3000K, 10W, CRI 80) 1485 lm (3000K, 13W, CRI 80)
DELIVERED LUMEN OUTPUT	800 lm (3000K, 38°, 10W, CRI 80) 1065 lm (3000K, 38°, 13W, CRI 80)
NO. AND TYPE OF LED	1 high power density COB LED 2-step MacAdam, 50000h L95 B10 (Ta 25°C)
MATERIAL	body in black-anodized anticorrosion aluminium screen in grey-serigraphed and transparent, tempered extra-clear glass
POWER SUPPLY UNIT	not included, see p. 904
MOUNTING	recessed (ceiling, wall, ground)
ACCESSORIES	see p. 122
FEATURES	16°x69° optics adjustable through 360° using the magnet provided
NOTES	version with screen in white-serigraphed glass available on request
PHOTOMETRIC DATA	see p. 850







^
LITUS 2.4
 3000K, 7W, 61° sharp
 with anti-glare screen

ANTI-GLARE ACCESSORIES



- WH0100** (Litus 1.0 / 1.6)
- WH0203** (Litus 2.4 / 2.5)
- WH0204** (Litus 5.4 / 5.5)
- WH0205** (Litus 5.6 / 5.7)

Honeycomb louvre built into the lighting fixture
 order together with the lighting fixture
 the honeycomb louvre can be fitted:
 - on all optics except for sharp, diffuse and 16°x69° adjustable optics
 - on 5° and 8° optics on request



- WE06005** (Litus 1.0 / 1.6)
- WE06015** (Litus 1.1 / 1.7)
- WE06025** (Litus 2.4 / 2.8)
- WE06035** (Litus 2.5 / 2.9)
- WE06045** (Litus 5.4 / 5.6)
- WE06055** (Litus 5.5 / 5.7)

Anti-glare screen, half transparent and half serigraphed black built into the lighting fixture
 order together with the lighting fixture
 the anti-glare screen can be fitted on the versions with white LED colour and on all optics except for the 48° optics

ACCESSORIES FOR INSTALLATION



WC4010
 Outer casing
 (Litus 1.0 / 1.6)



WC4011
 Outer casing
 (Litus 1.1 / 1.7)



WC4020
 Outer casing
 (Litus 2.4 / 2.8)



WC4021
 Outer casing
 (Litus 2.5 / 2.9)



WC4050
 Outer casing
 (Litus 5.4 / 5.6)



WC4051
 Outer casing
 (Litus 5.5 / 5.7)

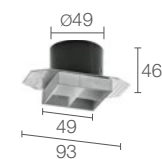

WC4511
 Outer casing for plasterboard
 (Litus 1.1 / 1.7)

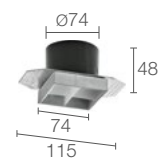

WC4521
 Outer casing for plasterboard
 (Litus 2.5 / 2.9)

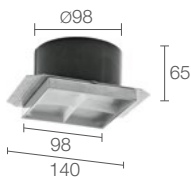

WC4551
 Outer casing for plasterboard
 (Litus 5.5 / 5.7)



WL0100
 Suction cup
 (Litus 1.0 / 1.1 / 1.6 / 1.7 / 2.4 / 2.5 / 2.8 / 2.9)



WL0500
 Suction cup
 (Litus 5.4 / 5.5 / 5.6 / 5.7)

for spare parts, see p. 932

ACCESSORIES

∨
LITUS 5.6
RGB, 7W, 45°





OUTDOOR RECESSED WITH BUILT-IN POWER SUPPLY

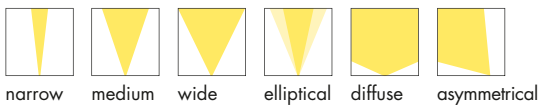
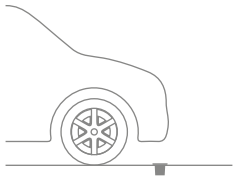

UP TO 3 m

Ø85 mm



CORSO 1.0 p. 128
3.5W 110-230Vac
ON/OFF



UP TO 5 m

Ø112 mm



CORSO 2.0 p. 128
8W 110-230Vac
ON/OFF



UP TO 7 m

Ø148 mm



CORSO 3.0 p. 129
15W 230Vac
ON/OFF



UP TO 10 m

Ø200 mm



CORSO 4.0 p. 129
21W 230Vac
ON/OFF
DALI + PUSH



IP65 / IP67
INGRESS PROTECTION



IP69K
RESISTANT TO CLEANING WITH HIGH-PRESSURE,
HIGH-TEMPERATURE SPRAY-DOWNS
(ISO 20653 COMPLIANT)



BUILT-IN PROTECTION SYSTEMS:
IPS
INTELLIGENT PROTECTION SYSTEM



PID
PROTECTIVE IMPEDANCE DEVICE



MAXIMUM RESISTANCE TO CORROSION
The carbon-fibre-reinforced, semi-crystalline technopolymer used for the fixture's body cannot be damaged by atmospheric agents and is the ideal choice for saline and high-corrosion environments. In addition, as it is a thermally conductive material, it is a highly efficient heat dissipater, so the power supply can be housed inside the body.



IK08
TRANSPARENT EXTRA-CLEAR GLASS, UP TO
12 MM THICK, HIGH TRANSMITTANCE
TO ENSURE CHROMATIC UNIFORMITY
OF LIGHT AND TEMPERED FOR EXCELLENT
RESISTANCE TO KNOCKS AND SCRATCHES

TRIM IN AISI 316L STAINLESS STEEL,
MADE WITH A CNC LATHE

IP68 WATERTIGHT CONNECTOR: THE 230VAC BUILT-IN
POWER SUPPLY UNIT ALLOWS THE FIXTURE TO
BE CONNECTED DIRECTLY TO THE NEOPRENE CABLE
WITHOUT THE NEED FOR REMOTE DRIVERS



DRIVE-OVER UP
TO 2000 KG

UNIQUE SELLING POINTS

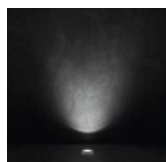

ASYMMETRICAL
OPTICS OPTIMALLY
DIRECT THE LIGHT
OUTPUT TOWARDS
THE SURFACE TO BE LIT



ANTI-GLARE
HONEYCOMB LOUVRE
ACCESSORY

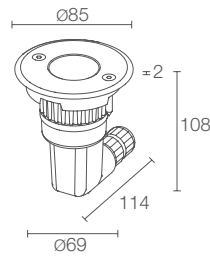

12°x45° optics

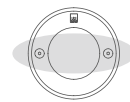
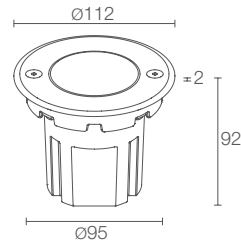

14°x43° optics



CORSO 1.0

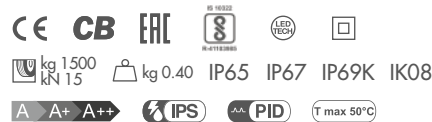

POWER / POWER SUPPLY CODE	3.5W 110-230Vac CR1010000 ■ ■ 0 ■ I
CONTROL SYSTEM	on/off
HONEYCOMB LOUVRE	0 - not present 1 - present (not compatible with the diffuse optics)
LED COLOUR	F - 2700K 5 - 3000K 9 - 4000K
OPTICS	S - 13° M - 28° L - 37° W - 12°x45° D - diffuse

CORSO 2.0



POWER / POWER SUPPLY CODE	8W 110-230Vac CR2010000 ■ ■ 0 ■ I
CONTROL SYSTEM	on/off
HONEYCOMB LOUVRE	0 - not present 1 - present (not compatible with the diffuse optics)
LED COLOUR	F - 2700K 5 - 3000K 9 - 4000K
OPTICS	S - 12° M - 36° L - 70° W - 14°x43° D - diffuse

LUMEN OUTPUT AT SOURCE	224 lm (3000K)
DELIVERED LUMEN OUTPUT	178 lm (3000K, 13°)
NO. AND TYPE OF LED	1 power LED 1/4 ANSI BIN, 50000h L90 B10 (Ta 25°C)
MATERIAL	body in thermally conductive plastic trim in AISI 316L stainless steel screen in transparent, tempered extra-clear glass
POWER SUPPLY UNIT	built in
MOUNTING	recessed (wall, ground)
ACCESSORIES	see p. 131
FEATURES	fast installation: direct connection between fixture and mains power supply
NOTES	Casambi-compatible version, controllable with the Casambi app, available on request
PHOTOMETRIC DATA	see p. 818

LUMEN OUTPUT AT SOURCE	657 lm (3000K)
DELIVERED LUMEN OUTPUT	504 lm (3000K, 36°)
NO. AND TYPE OF LED	1 high-intensity power LED 3-step MacAdam, 50000h L90 B10 (Ta 25°C)
MATERIAL	body in thermally conductive plastic trim in AISI 316L stainless steel screen in serigraphed-grey and transparent, tempered extra-clear glass
POWER SUPPLY UNIT	built in
MOUNTING	recessed (wall, ground)
ACCESSORIES	see p. 131
FEATURES	fast installation: direct connection between fixture and mains power supply
NOTES	Casambi-compatible version, controllable with the Casambi app, available on request
PHOTOMETRIC DATA	see p. 818



CORSO 3.0



15W 230Vac
CR3010000 ■ ■ ■ ■ ■

on/off

- **0** - not present
1 - present
 (not compatible with 12°x67°, asymmetrical and diffuse optics)
- **F** - 2700K
5 - 3000K
9 - 4000K
- **S** - 13°
M - 40°
L - 58°
W - 12°x67°
A - asymmetrical
D - diffuse

1360 lm (3000K)

1112 lm (3000K, 40°)

1 high power density COB LED
 3-step MacAdam, 50000h L95 B10 (Ta 25°C)

body in thermally conductive plastic
 trim in AISI 316L stainless steel
 screen in serigraphed-grey and transparent,
 tempered extra-clear glass

built in

recessed (wall, ground)

see p. 131

fast installation: direct connection between
 fixture and mains power supply

Casambi-compatible version, controllable with
 the Casambi app, available on request

see p. 819

CORSO 4.0



21W 230Vac
CR40100 ■ ■ ■ ■ ■

- **0** - on/off
D - DALI + PUSH

- **0** - not present
1 - present
 (not compatible with 14°x69°, asymmetrical and diffuse optics)

- **F** - 2700K
5 - 3000K
9 - 4000K

- **S** - 13°
M - 38°
L - 71°
W - 14°x69°
A - asymmetrical
D - diffuse

2200 lm (3000K)

1740 lm (3000K, 13°)

1 high power density COB LED
 3-step MacAdam, 50000h L90 B10 (Ta 25°C)

body in thermally conductive plastic
 trim in AISI 316L stainless steel
 screen in serigraphed-grey and transparent,
 tempered extra-clear glass

built in

recessed (wall, ground)

see p. 131

fast installation: direct connection between
 fixture and mains power supply

version with in/out connection available on request
 Casambi-compatible version, controllable with
 the Casambi app, available on request

see p. 819



ACCESSORIES

ACCESSORIES FOR INSTALLATION



WCA04
Outer casing
(Corso 1.0)



WC0105
Outer casing
(Corso 2.0)



WC0601
Outer casing
(Corso 3.0)



WC0701
Outer casing
(Corso 3.0)



WCA03
Outer casing
(Corso 4.0)



OUTDOOR RECESSED UPLIGHTS ARCHITECTURAL LIGHTING FOR LARGE BUILDINGS

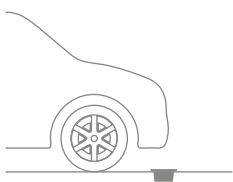

2700K 3000K 4000K

2700K 3000K 4000K



FIXED OPTICS Ø290



narrow medium wide elliptical wall washer



STRA 1.0 p. 136
37W 230Vac
ON/OFF, 0/1-10V



STRA 5.0 p. 138
39W 24Vdc

ADJUSTABLE OPTICS Ø290



narrow medium wide elliptical



STRA 2.0 p. 136
1 set of optics
25W 230Vac
ON/OFF



STRA 3.0 p. 137
2 sets of optics
25W 230Vac
ON/OFF



STRA 4.0 p.137
1 set of optics
25W 230Vac
ON/OFF





IP67 / IP68
WITH PURPOSE-BUILT OUTER CASING



IP69K
RESISTANT TO CLEANING WITH HIGH-PRESSURE,
HIGH-TEMPERATURE SPRAY-DOWNS
(ISO 20653 COMPLIANT)



BUILT-IN PROTECTION SYSTEMS:

IPS

INTELLIGENT PROTECTION SYSTEM



PID

PROTECTIVE IMPEDANCE DEVICE



SPD

SURGE PROTECTION DEVICE



BUILT-IN POWER
SUPPLY UNIT



6-STEP MATERIAL PROTECTION,
AND OXIDATION AND
CORROSION RESISTANCE

EN AB 47100 low-copper-content aluminium alloy

Preparation for painting

Epoxy paint

Polyester paint

Paints compliant with Qualicoat automotive coating standard

Salt spray tested (over 1500 hours)



IK10

TRANSPARENT, TEMPERED EXTRA-CLEAR
GLASS WITH VITRIFIED SERIGRAPHY,
HIGH TRANSMITTANCE TO ENSURE
CHROMATIC UNIFORMITY.
THE GLASS'S THICKNESS OF 15 MM
GUARANTEES MAXIMUM IMPACT RESISTANCE

TRIM IN AISI 316L STAINLESS STEEL,
PRODUCED ENTIRELY ON A CNC LATHE,
MICRO-PEENED, PASSIVATED
AND ELECTROPOLISHED.
THE BEST CORROSION TREATMENT



DRIVE-OVER UP
TO 5000 KG



STRA 1.0

66°x11° OPTICS ADJUSTABLE THROUGH 360°
USING MAGNET INCLUDED (PATENTED)

UNIQUE SELLING POINTS



INFRARED REMOTE CONTROL TO REMOTELY ADJUST THE LIGHT BEAM BY $\pm 10^\circ$ (STRA 4.0)



IP68 STAINLESS STEEL OUTER CASING FOR INSTALLATION WITHOUT DRAINAGE



ANTI-GLARE RECESSED OPTICS



PROJECTOR VERSION: STRA P, P. 290



WALL WASHER OPTICS (STRA 1.0)



TWO INDEPENDENT OPTICAL GROUPS (STRA 3.0)

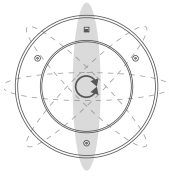

Adjustable 66°x11° optics
(Stra 1.0)

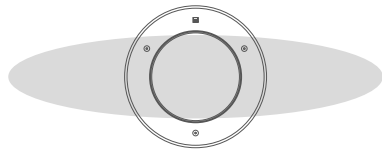

10°x45° optics
(Stra 1.0 / 2.0 / 4.0)

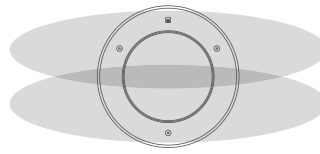

10°x45° optics
(Stra 3.0)



elliptical optics,
adjusted manually
with magnet

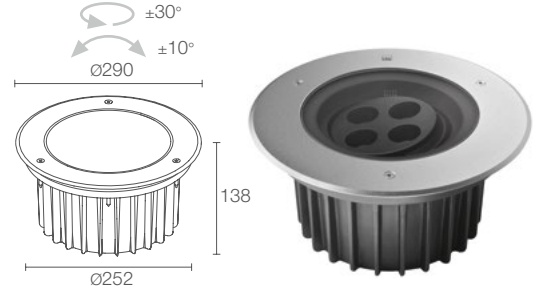
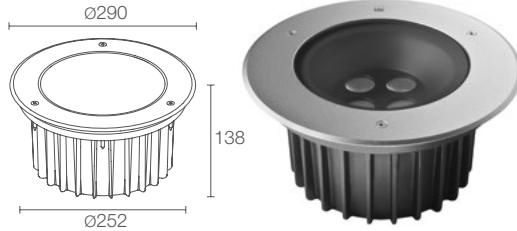

STRA 1.0

Ø 660 mm H 265 mm Ø 210 mm

CE ENEC S LED TECH kg 5000 kN 50 kg 5.00
IP67 IP68 with purpose-built outer casing IP69K IK10 0/1-10V
A A+ A++ IPS PID SPD T max 50°C

POWER / POWER SUPPLY CODE

37W 230Vac
CS1010 ■ ■ ■ I Stainless steel
37W 230Vac 0/1-10V
CS1010 ■ ■ ■ IR Stainless steel

■ CRI	0 - CRI 80 1 - CRI >90
■ LED COLOUR	F - 2700K 5 - 3000K 9 - 4000K
■ OPTICS	V - 11° S - 14° M - 30° L - 37° W - 10°x45° X - 66°x11° adjustable H - wall washer

LUMEN OUTPUT AT SOURCE	3402 lm (3000K, CRI 80)
DELIVERED LUMEN OUTPUT	2024 lm (3000K, 30°, CRI 80) 2205 lm (3000K, 66°x11°, CRI 80)
NO. AND TYPE OF LED	4 high-intensity power LEDs 3-step MacAdam, 50000h L90 B10 (Ta 25°C)
MATERIAL	body in die-cast aluminium trim in AISI 316L stainless steel screen in serigraphed and transparent, tempered extra-clear glass
POWER SUPPLY UNIT	built in
POWER CABLES	includes 1.5 m neoprene cable H07RN-F 3x1.00 Ø9.3 mm
MOUNTING	recessed (ground)
ACCESSORIES	see p. 139
FEATURES	66°x11° optics adjustable through 360° using the magnet provided
NOTES	not suitable for use in swimming pools or fountains projector version: Stra P 1.0, p. 291 DALI version available on request Casambi-compatible version, controllable with the Casambi app, available on request
PHOTOMETRIC DATA	see p. 887

STRA 2.0

Ø 660 mm H 265 mm Ø 210 mm

CE ENEC S LED TECH kg 5000 kN 50 kg 5.00
IP67 IP68 with purpose-built outer casing IP69K IK10
A A+ A++ IPS PID SPD T max 50°C

25W 230Vac
CS2010 ■ ■ ■ I Stainless steel

■ CRI	0 - CRI 80 1 - CRI >90
■ LED COLOUR	F - 2700K 5 - 3000K 9 - 4000K
■ OPTICS	V - 11° adjustable S - 14° adjustable M - 30° adjustable L - 37° adjustable W - 10°x45° adjustable

LUMEN OUTPUT AT SOURCE	2322 lm (3000K, CRI 80)
DELIVERED LUMEN OUTPUT	1350 lm (3000K, 30°, CRI 80)
NO. AND TYPE OF LED	4 high intensity-power LEDs 3-step MacAdam, 50000h L85 B10 (Ta 25°C)
MATERIAL	body in die-cast aluminium trim in AISI 316L stainless steel screen in serigraphed and transparent, tempered extra-clear glass
POWER SUPPLY UNIT	built in
POWER CABLES	includes 1.5 m neoprene cable H07RN-F 3x1.00 Ø9.3 mm
MOUNTING	recessed (ground)
ACCESSORIES	see p. 139
FEATURES	manually adjustable optics: ±10° on z-axis, ±30° on x-axis
NOTES	not suitable for use in swimming pools or fountains Casambi-compatible version, controllable with the Casambi app, available on request
PHOTOMETRIC DATA	see p. 888

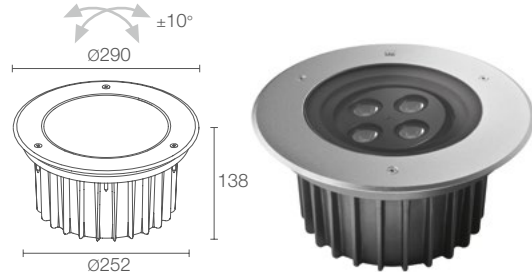
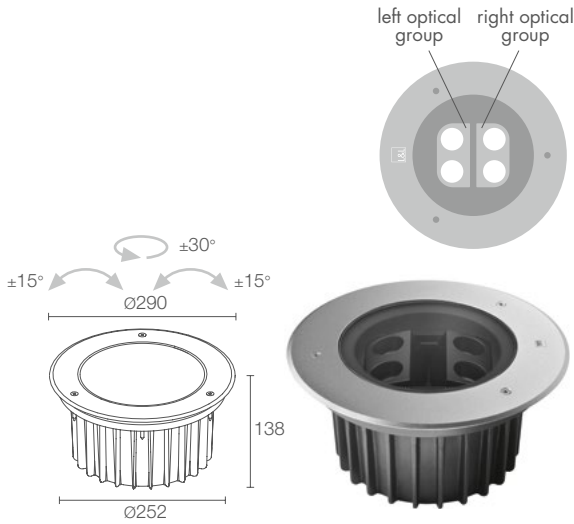

patent pending

STRA 3.0

Ø 660 mm
H 265 mm

Ø 210 mm



CE ENEC LED TECH kg 5000 kN 50 kg 5.00
IP67 IP68 IP69K IK10
with purpose-built outer casing
A A+ A++ IPS PID SPD T max 50°C

25W 230Vac
CS3010 Stainless steel

STRA 4.0

Ø 660 mm
H 265 mm

Ø 210 mm



Required infrared remote control, not included

CE ENEC LED TECH kg 5000 kN 50 kg 5.00
IP67 IP68 IP69K IK10
with purpose-built outer casing
A A+ A++ IPS PID SPD T max 50°C

25W 230Vac
CS4010 Stainless steel

0 - CRI 80 1 - CRI >90	
F - 2700K 5 - 3000K 9 - 4000K	
left optics: V - 11° adjustable S - 14° adjustable M - 30° adjustable L - 37° adjustable W - 10°x45° adjustable	right optics: V - 11° adjustable S - 14° adjustable M - 30° adjustable L - 37° adjustable W - 10°x45° adjustable

0 - CRI 80 1 - CRI >90	
F - 2700K 5 - 3000K 9 - 4000K	
S - 14° adjustable M - 30° adjustable L - 37° adjustable W - 10°x45° adjustable	

2411 lm (3000K, CRI 80)

1395 lm (3000K, 30°, CRI 80)

4 high intensity-power LEDs
3-step MacAdam, 50000h L85 B10 (Ta 25°C)

body in die-cast aluminium
trim in AISI 316L stainless steel
screen in serigraphed and transparent,
tempered extra-clear glass

built in

includes 1.5 m neoprene cable
H07RN-F 3x1.00 Ø9.3 mm

recessed (ground)

see p. 139

2 optical groups, adjustable manually and singly:
±15° on the z axis, ±30° on the x axis

not suitable for use in swimming pools or fountains
Casambi-compatible version, controllable with
the Casambi app, available on request

see p. 888

2411 lm (3000K, CRI 80)

1395 lm (3000K, 30°, CRI 80)

4 high-intensity power LEDs
3-step MacAdam, 50000h L85 B10 (Ta 25°C)

body in die-cast aluminium
trim in AISI 316L stainless steel
screen in serigraphed and transparent,
tempered extra-clear glass

built in

includes 1.5 m neoprene cable
H07RN-F 3x1.00 Ø9.3 mm

recessed (ground)

see p. 139

motorized adjustable optics:
±10° in every direction

not suitable for use in swimming pools or fountains
Casambi-compatible version, controllable with
the Casambi app, available on request

see p. 888

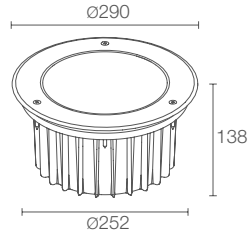

STRA 5.0

Ø 660 mm
H 265 mm

Ø 210 mm

IP67 IP68 IP69K IK10
with purpose-built
outer casing

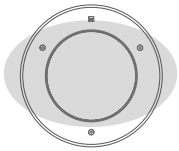

32°x61° optics

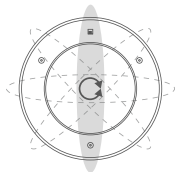

Adjustable
66°x11° optics



elliptical optics,
adjusted manually
with magnet

POWER / POWER SUPPLY CODE	39W 24Vdc CS5000 7 H Stainless steel
OPTICS	S - 24° M - 33° L - 60° W - 32°x61° X - 66°x11° adjustable H - wall washer
LED COLOUR	RGBW
LUMEN OUTPUT AT SOURCE	2048 lm, R: 352 lm G: 640 lm B: 208 lm W: 848 lm (4000K)
DELIVERED LUMEN OUTPUT	1216 lm, R: 209 lm G: 380 lm B: 123 lm W: 504 lm (4000K, 33°)
NO. AND TYPE OF LED	4 RGBW power LED groups 50000h L85 B10 (Ta 25°C)
MATERIAL	body in die-cast aluminium trim in AISI 316L stainless steel screen in serigraphed and transparent, tempered extra-clear glass
POWER SUPPLY UNIT	not included, see p. 904 and 917
POWER CABLES	includes 1.5 m FEP+RUB cable (equivalent to H05RN-F) 6x0.50/0.50 Ø6.3 mm
MOUNTING	recessed (ground)
ACCESSORIES	see p. 139
FEATURES	66°x11° optics adjustable through 360° using the magnet provided
NOTES	not suitable for use in swimming pools or fountains projector version: Stra P 5.0, p. 292
PHOTOMETRIC DATA	see p. 889

ACCESSORIES

ANTI-GLARE ACCESSORIES



WH0610

Honeycomb louvre
built into the lighting fixture

order together with
the lighting fixture

the honeycomb louvre can be fitted on all
optics except for 66°x11° and wall washer optics

ACCESSORIES FOR INSTALLATION



WC5610

Stainless steel outer casing
(Stra IP67)



WC5611

Stainless steel outer casing
(Stra IP68)

WE0202

Tamper-resistant screw kit

WE0203

Screwdriver for tamper-resistant screws

TLC07

Infrared remote control
(Stra 4.0)

for spare parts, see p. 932

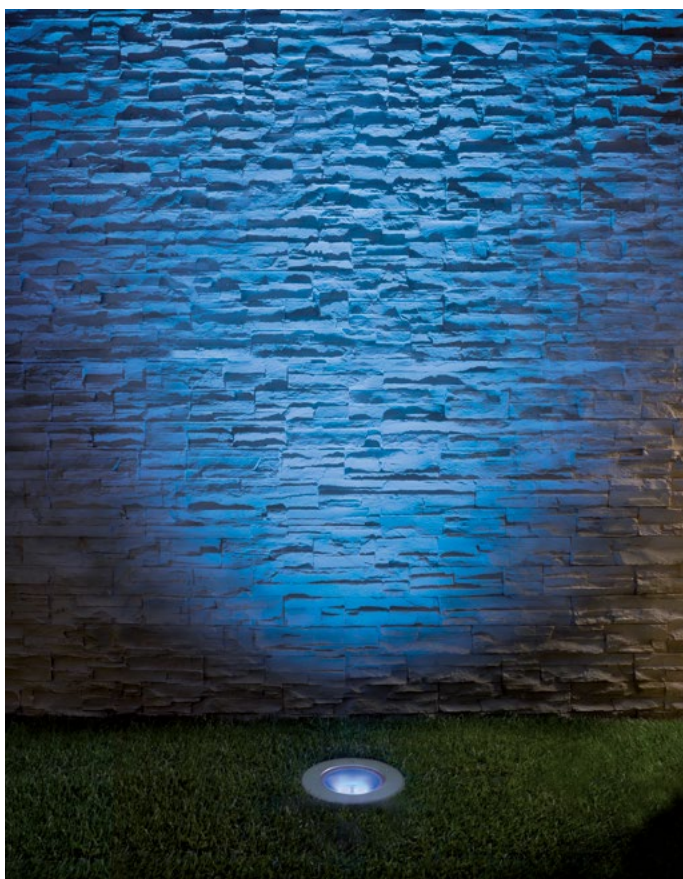



OUTDOOR RECESSED UPLIGHTS LIGHTING FOR WALKWAYS

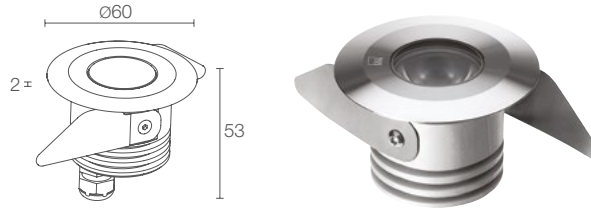

BEAM 1.0

Ø 80 mm H 100 mm Ø 45 mm



POWER / POWER SUPPLY CODE

max 3W max 700mA blue/white light
CD1013 ■ **A I** - ■ Stainless steel
CD1013 ■ **A F** - ■ Grey
 max 3W max 350mA RGB light
CD1011 6 ■ **A I** - ■ Stainless steel
CD1011 6 ■ **A F** - ■ Grey

■ LED COLOUR	F - 2700K 5 - 3000K 9 - 4000K 0 - 5000K 1 - blue
■ OPTICS	S - 8° M - 26° L - 44° D - diffuse RGB: S - 19° M - 30° L - 37° D - diffuse
■ POWER CABLES	includes 1.5 m neoprene cable H05RN-F 2x0.35/0.75 Ø6.3 mm RGB: includes 1.5 m FEP+RUB cable (equivalent to H05RN-F) 6x0.50/0.50 Ø6.3 mm 1 - 5 m 2 - 10 m 3 - 15 m 4 - 20 m

LUMEN OUTPUT AT SOURCE	184 lm (3000K, 700mA) RGB: 217 lm, R: 80 lm G: 104 lm B: 33 lm (350mA)
DELIVERED LUMEN OUTPUT	114 lm (3000K, 700mA, 26°) RGB: 154 lm, R: 57 lm G: 74 lm B: 23 lm (350mA, 19°)
NO. AND TYPE OF LED	1 power LED, 1/4 ANSI BIN (white LED colour) RGB: 3 full-colour LEDs 50000h L80 B10 (Ta 25°C)
MATERIAL	body in anodized aluminium trim in AISI 316L stainless steel or aluminium screen in transparent extra-clear glass (optics version) screen in sandblasted extra-clear glass (diffuse version)
POWER SUPPLY UNIT	not included, see p. 904 and 917
WIRING	series
MOUNTING	recessed (ceiling, wall, ground)
ACCESSORIES	see p. 143
NOTES	version with 24Vdc power supply and version certified ETL available on request
PHOTOMETRIC DATA	see p. 781



< **BEAM 1.0**
RGB, 3W, 30°, stainless steel

Project and light planning by / DVDV Studio Architetti
 Photo by / Alessio Tamborini
 Private residence, Milan, Italy



ACCESSORIES

ACCESSORIES FOR INSTALLATION



WC1501
Outer casing

3D Model / W_Lemay, 3D Warehouse

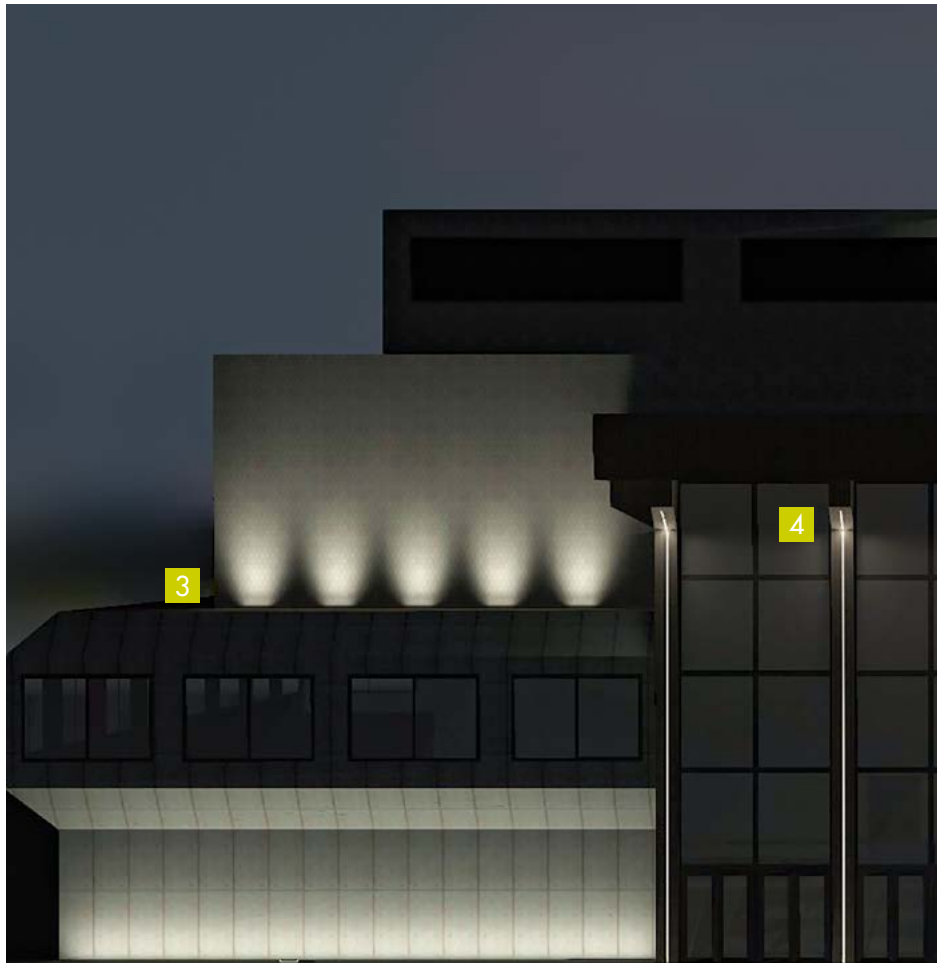

LINEAR PROFILES FOR OUTDOOR APPLICATIONS

ARCHITECTURAL

COLORADO p. 148 **1**

TAGO p. 166 **2**

NEVA p. 184 **3**

URBAN SPACES

RIO p. 206 **4**

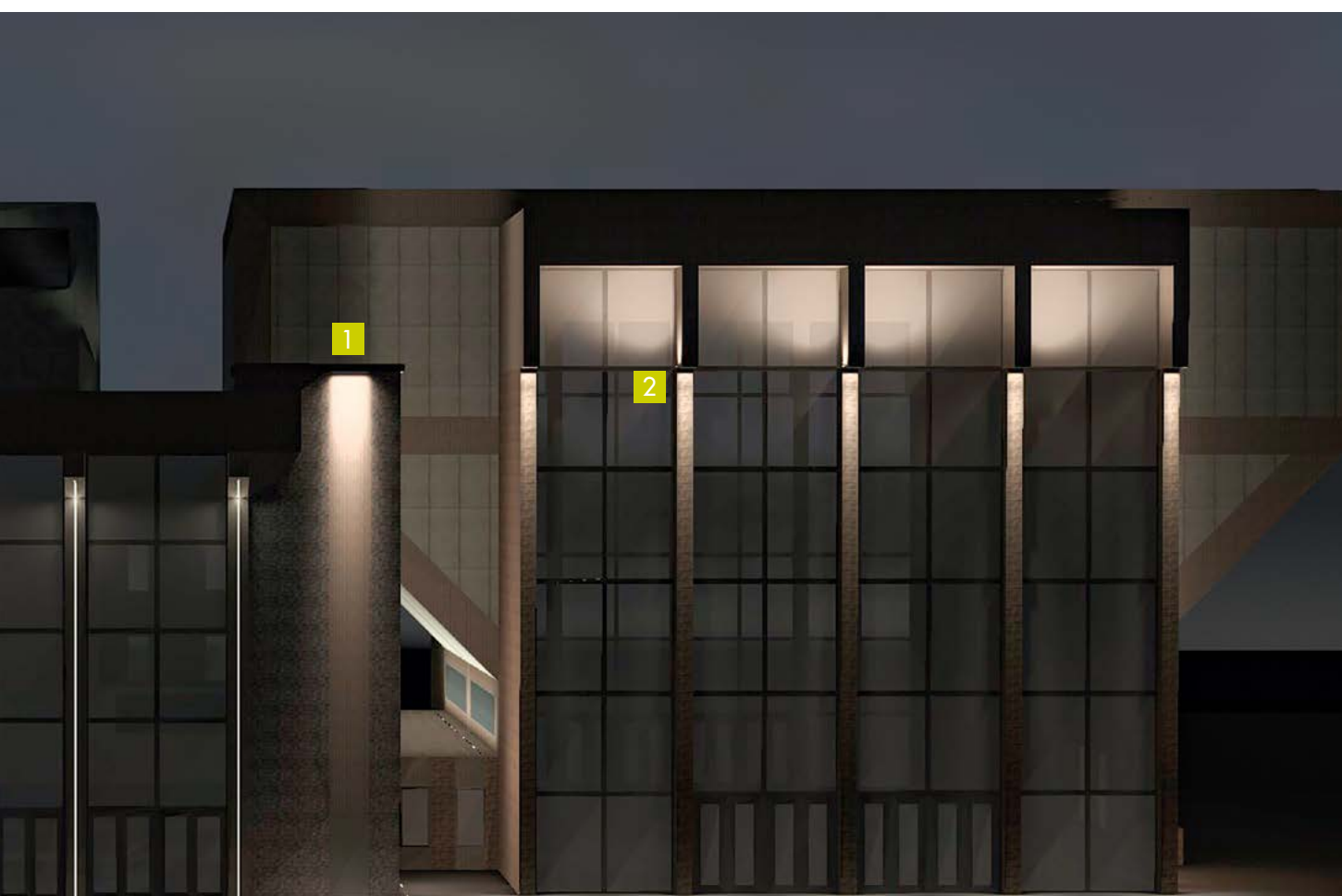





ARCHITECTURAL

MOUNTING

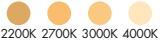
BEAM

LIGHT COLOUR

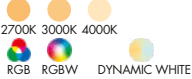
<p>COLORADO see p. 148</p> 	<p>GROUND recessed</p> <p>CEILING WALL GROUND with brackets</p>	<p>DIFFUSE VERSION</p> <p>OPTICS VERSION</p>	 <p>2200K 2700K 3000K 4000K</p>
<p>TAGO see p. 166</p> 	<p>GROUND recessed</p> <p>CEILING WALL GROUND with brackets</p>	<p>DIFFUSE VERSION</p> <p>OPTICS VERSION</p>	 <p>2200K 2700K 3000K 4000K</p> <p>RGBW</p>
<p>NEVA see p. 184</p> 	<p>CEILING WALL GROUND with brackets or recessed</p>	<p>OPTICS VERSION</p>	 <p>2700K 3000K 4000K</p> <p>RGB RGBW DYNAMIC WHITE</p>

URBAN SPACES

<p>RIO see p. 206</p> 	<p>CEILING WALL GROUND recessed</p>	<p>DIFFUSE VERSION</p>	 <p>2600K 2800K 3700K RGB</p>
--	-------------------------------------	------------------------	--

LINEAR PROFILES FOR OUTDOOR APPLICATIONS

POWER SUPPLY	CONTROL SYSTEM	PITCH	IP	APPLIANCE CLASS
MAINS VOLTAGE (built-in power supply unit) 230Vac	0/1-10V / DALI	20	IP65 IP67	⊕ □
CONSTANT VOLTAGE (power supply unit not included) 48Vdc (RGBW light) MAINS VOLTAGE (built-in power supply unit) 230Vac (white/RGBW light)	0/1-10V / DALI DMX512 / RDM	20 / 41.7	IP65 IP67	⊕ ⬠
CONSTANT VOLTAGE (power supply unit not included) 24Vdc MAINS VOLTAGE (built-in power supply unit) 230Vac	DMX / RDM / 0/1-10V	60 / 120	IP65 IP67	□ ⬠
CONSTANT VOLTAGE (power supply unit not included) 24Vdc			IP67	⬠

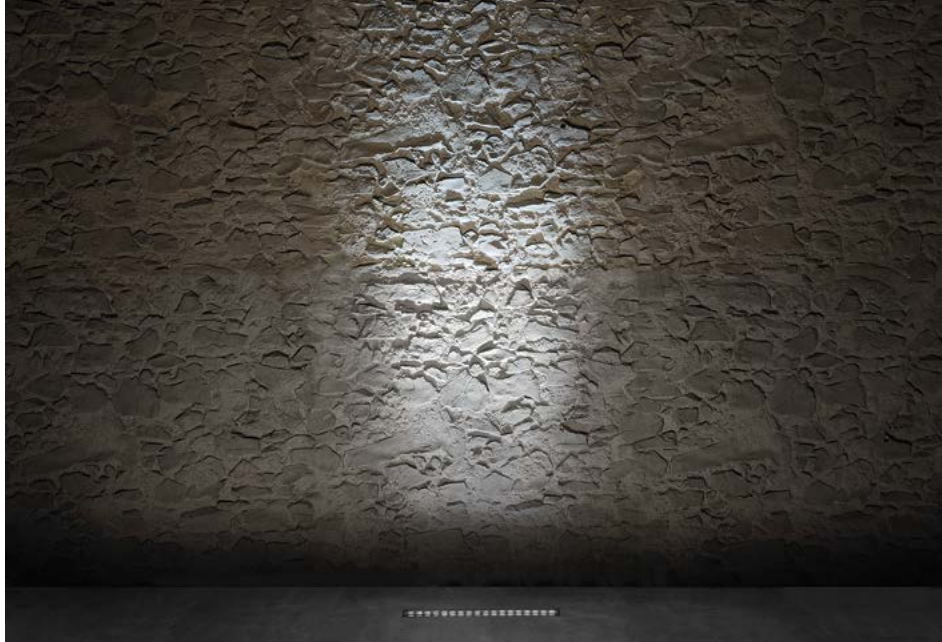

< **COLORADO 2.0**
3000K, 41W, 12°

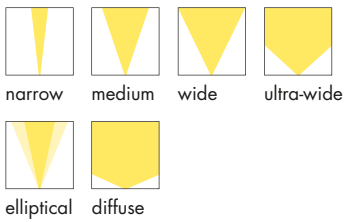

**RECESSED,
WITH REBATED FRAME**

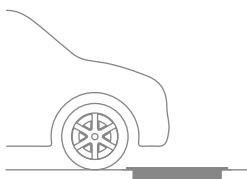

COLORADO 1.0 p. 152
41W 230Vac
ON/OFF, DALI-2, 0/1-10V
679 mm



COLORADO 1.1 p. 153
62W 230Vac
ON/OFF, DALI, 0/1-10V
979 mm



COLORADO 1.2 p. 153
83W 230Vac
ON/OFF, DALI-2, 0/1-10V
1279 mm

**RECESSED FLUSH,
WITHOUT FRAME**

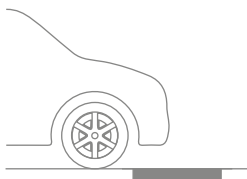

COLORADO 2.0 p. 154
41W 230Vac
ON/OFF, DALI-2, 0/1-10V
632 mm



COLORADO 2.1 p. 155
62W 230Vac
ON/OFF, DALI, 0/1-10V
932 mm



COLORADO 2.2 p. 155
83W 230Vac
ON/OFF, DALI-2, 0/1-10V
1232 mm

**SURFACE MOUNTED,
WITH BRACKETS**



COLORADO 3.0 p. 156
41W 230Vac
ON/OFF, DALI-2, 0/1-10V
625 mm



COLORADO 3.1 p. 157
62W 230Vac
ON/OFF, DALI, 0/1-10V
925 mm



COLORADO 3.2 p. 157
83W 230Vac
ON/OFF, DALI-2, 0/1-10V
1225 mm

OUTDOOR LINEAR PROFILES ARCHITECTURAL LIGHTING FOR FACADES UP TO 20 METRES TALL

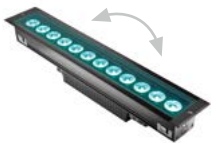

COLORADO 4.0 p. 158
43W 230Vac
DMX, RDM
679 mm

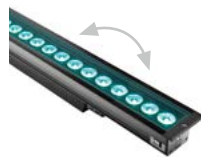

COLORADO 4.1 p. 159
64W 230Vac
DMX, RDM
979 mm

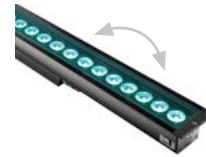

COLORADO 4.2 p. 159
85W 230Vac
DMX, RDM
1279 mm



COLORADO 5.0 p. 160
43W 230Vac
DMX, RDM
632 mm

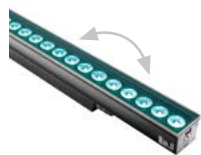

COLORADO 5.1 p. 161
64W 230Vac
DMX, RDM
932 mm

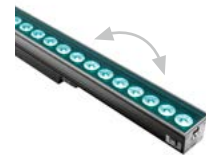

COLORADO 5.2 p. 161
85W 230Vac
DMX, RDM
1232 mm



COLORADO 6.0 p. 162
43W 230Vac
DMX, RDM
625 mm



COLORADO 6.1 p. 163
64W 230Vac
DMX, RDM
925 mm



COLORADO 6.2 p. 163
85W 230Vac
DMX, RDM
1225 mm

12°



IP65 / IP67

SUITABLE FOR OUTDOOR APPLICATIONS



BUILT-IN PROTECTION SYSTEMS:

PID

PROTECTIVE IMPEDANCE DEVICE



BUILT-IN
POWER SUPPLY UNIT



COLORADO 1 / 2 / 3
AVAILABLE IN DALI AND
0/1-10V DIMMABLE VERSIONS



COLORADO 4 / 5 / 6
LIGHTING CONTROL USING
THE DMX RDM PROTOCOL

30°

45°

MAXIMUM RESISTANCE TO CORROSION
COLORADO IS SUITABLE FOR INSTALLATION IN HARSH
ENVIRONMENTS SUCH AS THE SALINE CONDITIONS
FOUND IN MARITIME AREAS: THE COMBINATION OF A BODY
IN ANTICORODAL® LOW-COPPER-CONTENT ALUMINIUM
AND CAPS IN TECHNO-POLYMER ENSURES EXCELLENT HEAT
DISSIPATION AND OUTSTANDING CORROSION RESISTANCE



IK09 / IK10

SCREEN IN TRANSPARENT EXTRA-CLEAR GLASS,
UP TO 10 MM THICK, HIGH TRANSMITTANCE



TO ENSURE CHROMATIC UNIFORMITY OF LIGHT,
SERIGRAPHED GREY (RAL 7015), AND TEMPERED
FOR EXCELLENT IMPACT AND SCRATCH RESISTANCE

76°



COLORADO 1 / 4 DRIVE-OVER UP TO 2000 KG
COLORADO 2 DRIVE-OVER UP TO 1500 KG
COLORADO 5 DRIVE-OVER UP TO 1700 KG

ANTI-GLARE RECESSED OPTICS
TO ENSURE VISUAL COMFORT

LIGHTING PERFORMANCE
A LUMINOUS FLUX OF OVER
5700 LM PER SQUARE METRE
MEANS FACADES AS TALL
AS 20 METRES CAN BE LIT

15°x50°

diffuse

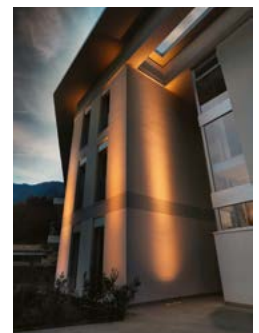

UNIQUE SELLING POINTS



AVAILABLE IN COLOUR TEMPERATURES 2700K, 3000K AND 4000K, AND IN A WARM 2200K COLOUR

to better respect the circadian cycles of people and animals in urban, green and public spaces



RGBW VERSION



IN/OUT CONNECTION

Easy wiring with quick connectors designed to connect the profiles in a line



COLORADO 3 / 6
THE BRACKET WITH TWO PIVOT POINTS ALLOWS THE LIGHT OUTPUT TO BE PRECISELY DIRECTED



ACCESSORY BRACKETS CAN BE ADJUSTED TO DIRECT THE LIGHT OUTPUT AS DESIRED

The fixture can be spaced up to 270 mm from the installation surface to reach past protruding architectural elements, such as cornices, corbels or cordons, and direct the light output where it is needed



COLORADO 1 / 2 / 3 ANTI-GLARE ACCESSORIES. THE HONEYCOMB LOUVRE OR ANTI-GLARE SHIELD, WHICH CAN BE ORDERED AT THE SAME TIME AS THE FIXTURE, IS MOUNTED ON THE OPTICAL UNIT, SO THAT THE CHOSEN OPTION TILTS TOGETHER WITH THE OPTICS IN THE RECESSED VERSION



COLORADO 1 / 2 TILTING SYSTEM INSIDE THE OPTICAL UNIT

The light direction can be altered by +/- 20° externally with a simple adjustment on the end caps, without compromising the fixture's IP65/IP67 protection level.

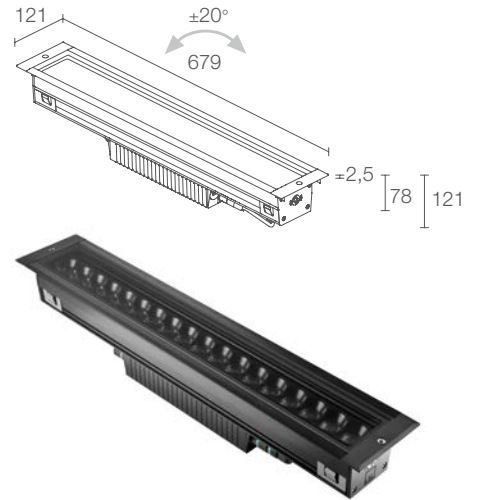

COLORADO 1.0

CE ENEC LED RoHS kWh 2000 kWh 20 kg 5.6 IP65 IP67 IK10
 A A+ A++ PID T max 40°C DALI-2 0/1-10V

POWER / POWER SUPPLY CODE	41W 230Vac 679 mm pitch 20 CA10100 ■ O ■ O ■ N Anodized black
CONTROL SYSTEM	0 - on/off 2 - 0/1-10V D - DALI-2
OPTICAL ACCESSORIES	0 - none 1 - honeycomb louvre (not compatible with diffuse optics) 2 - anti-glare shield (not compatible with diffuse optics)
LED COLOUR	N - 2200K F - 2700K 5 - 3000K 9 - 4000K
OPTICS	S - 12° tiltable ±20° M - 30° tiltable ±20° L - 45° tiltable ±20° K - 76° tiltable ±20° W - 15°x50° tiltable ±20° D - diffuse tiltable ±20°

LUMEN OUTPUT AT SOURCE	4950 lm (3000K)
DELIVERED LUMEN OUTPUT	3643 lm (3000K, 12°)
NO. AND TYPE OF LED	18 high-power LEDs pitch 20 mm, 2-step MacAdam, 60000h L80 B10 (Ta 25°C) 2200K: 3-step MacAdam, 60000h L80 B10 (Ta 25°C)
MATERIAL	body in black-anodized anticorodal aluminium screen in grey-serigraphed and transparent, tempered extra-clear glass; screen in grey-serigraphed, acid-etched, tempered extra-clear glass (diffuse version) caps in technopolymer
POWER SUPPLY UNIT	built in
MOUNTING	recessed (ground)
ACCESSORIES	see p. 164 and 165
FEATURES	optical accessories of honeycomb louvre and anti-glare shield built into the lighting fixture and tiltable together with the optics in/out connection and easy wiring with quick connectors designed to connect the profiles in a line
NOTES	Casambi-compatible version, controllable with the Casambi app, available on request
PHOTOMETRIC DATA	see p. 809

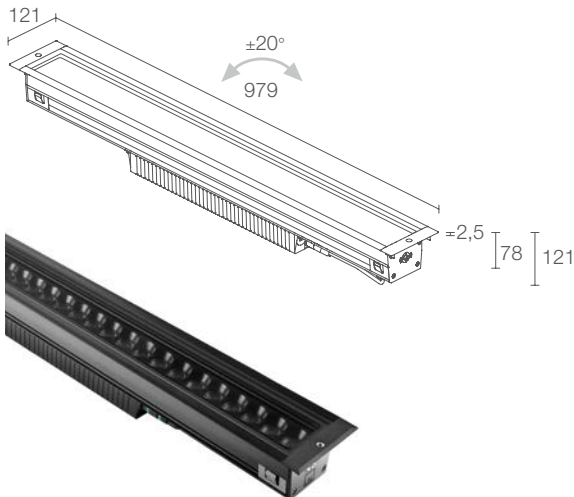

COLORADO 1.1

CE ENEC LED kg 2000 kg 8.5 IP65 IP67 IK10
A **A+** **A++** **PID** T_{max} 40°C DALI 0/1-10V

62W 230Vac 979 mm pitch 20

CA11100 ■ **O** ■ **O** ■ **N** Anodized black

■	O - on/off 2 - 0/1-10V D - DALI
■	O - none 1 - honeycomb louvre (not compatible with diffuse optics) 2 - anti-glare shield (not compatible with diffuse optics)
■	N - 2200K F - 2700K 5 - 3000K 9 - 4000K
■	S - 12° tiltable ±20° M - 30° tiltable ±20° L - 45° tiltable ±20° K - 76° tiltable ±20° W - 15°x50° tiltable ±20° D - diffuse tiltable ±20°

7425 lm (3000K)

5645 lm (3000K, 12°)

27 high-power LEDs pitch 20 mm, 2-step MacAdam, 60000h L80 B10 (T_a 25°C)
 2200K: 3-step MacAdam, 60000h L80 B10 (T_a 25°C)

body in black-anodized anticorrosion aluminium
 screen in grey-serigraphed and transparent, tempered extra-clear glass; screen in grey-serigraphed, acid-etched, tempered extra-clear glass (diffuse version)
 caps in technopolymer

built in

recessed (ground)

see p. 164 and 165

optical accessories of honeycomb louvre and anti-glare shield built into the lighting fixture and tiltable together with the optics
 in/out connection and easy wiring with quick connectors designed to connect the profiles in a line

Casambi-compatible version, controllable with the Casambi app, available on request

see p. 809

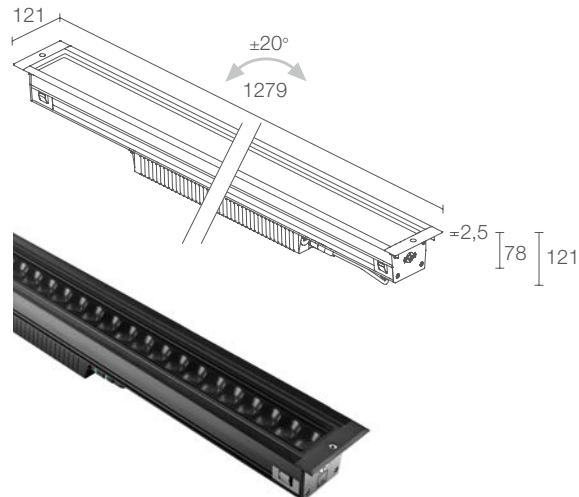

COLORADO 1.2

CE ENEC LED kg 2000 kg 10.5 IP65 IP67 IK10
A **A+** **A++** **PID** T_{max} 40°C DALI-2 0/1-10V

83W 230Vac 1279 mm pitch 20

CA12100 ■ **O** ■ **O** ■ **N** Anodized black

■	O - on/off 2 - 0/1-10V D - DALI-2
■	O - none 1 - honeycomb louvre (not compatible with diffuse optics) 2 - anti-glare shield (not compatible with diffuse optics)
■	N - 2200K F - 2700K 5 - 3000K 9 - 4000K
■	S - 12° tiltable ±20° M - 30° tiltable ±20° L - 45° tiltable ±20° K - 76° tiltable ±20° W - 15°x50° tiltable ±20° D - diffuse tiltable ±20°

9900 lm (3000K)

7286 lm (3000K, 12°)

36 high-power LEDs pitch 20 mm, 2-step MacAdam, 60000h L80 B10 (T_a 25°C)
 2200K: 3-step MacAdam, 60000h L80 B10 (T_a 25°C)

body in black-anodized anticorrosion aluminium
 screen in grey-serigraphed and transparent, tempered extra-clear glass; screen in grey-serigraphed, acid-etched, tempered extra-clear glass (diffuse version)
 caps in technopolymer

built in

recessed (ground)

see p. 164 and 165

optical accessories of honeycomb louvre and anti-glare shield built into the lighting fixture and tiltable together with the optics
 in/out connection and easy wiring with quick connectors designed to connect the profiles in a line

Casambi-compatible version, controllable with the Casambi app, available on request

see p. 809

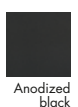

Anodized black

✓
COLORADO 2.0
 2200K, 41W, 12°

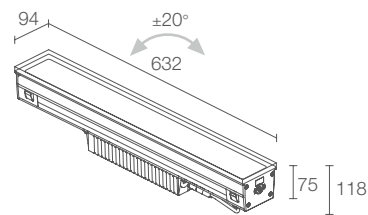

Installation flush
 with ground



COLORADO 2.0

CE ENEC LED IEC kg 1500 KN 15 kg 6.0 IP65 IP67 IK10
 A A+ A++ PID T max 40°C DALI-2 0/1-10V

POWER / POWER SUPPLY CODE	41W 230Vac 632 mm pitch 20 CA20100 ■ 0 ■ 0 ■ 0 ■ V
CONTROL SYSTEM	0 - on/off 2 - 0/1-10V D - DALI-2
OPTICAL ACCESSORIES	0 - none 1 - honeycomb louvre (not compatible with diffuse optics) 2 - anti-glare shield (not compatible with diffuse optics)
LED COLOUR	N - 2200K F - 2700K 5 - 3000K 9 - 4000K
OPTICS	S - 12° tiltable ±20° M - 30° tiltable ±20° L - 45° tiltable ±20° K - 76° tiltable ±20° W - 15°x50° tiltable ±20° D - diffuse tiltable ±20°
LUMEN OUTPUT AT SOURCE	4950 lm (3000K)
DELIVERED LUMEN OUTPUT	3643 lm (3000K, 12°)
NO. AND TYPE OF LED	18 high-power LEDs pitch 20 mm, 2-step MacAdam, 60000h L80 B10 (Ta 25°C) 2200K: 3-step MacAdam, 60000h L80 B10 (Ta 25°C)
MATERIAL	body in black-anodized anticorodal aluminium screen in grey-serigraphed and transparent, tempered extra-clear glass; screen in grey-serigraphed, acid-etched, tempered extra-clear glass (diffuse version) caps in technopolymer
POWER SUPPLY UNIT	built in
MOUNTING	recessed (ground)
ACCESSORIES	see p. 164 and 165
FEATURES	optical accessories of honeycomb louvre and anti-glare shield built into the lighting fixture and tiltable together with the optics in/out connection and easy wiring with quick connectors designed to connect the profiles in a line
NOTES	Casambi-compatible version, controllable with the Casambi app, available on request
PHOTOMETRIC DATA	see p. 809

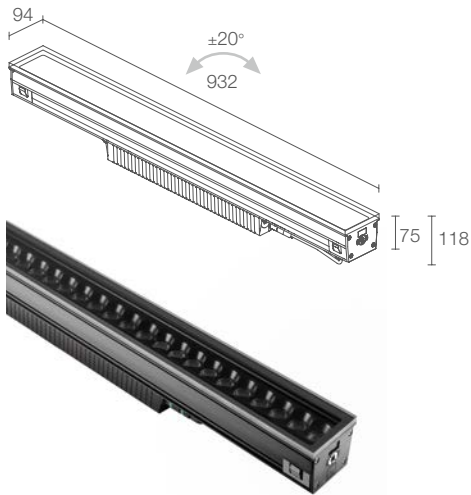

COLORADO 2.1

CE ENEC LED kg 1500 kg 8.6 IP65 IP67 IK10
A **A+** **A++** **PID** $T_{max} 40^{\circ}C$ DALI 0/1-10V

62W 230Vac 932 mm pitch 20
CA21100 ■ **0** ■ **0** ■ **0** ■ **V**

■	0 - on/off 2 - 0/1-10V D - DALI
■	0 - none 1 - honeycomb louvre (not compatible with diffuse optics) 2 - anti-glare shield (not compatible with diffuse optics)
■	N - 2200K F - 2700K 5 - 3000K 9 - 4000K
■	S - 12° tiltable ±20° M - 30° tiltable ±20° L - 45° tiltable ±20° K - 76° tiltable ±20° W - 15°x50° tiltable ±20° D - diffuse tiltable ±20°

7425 lm (3000K)

5645 lm (3000K, 12°)

27 high-power LEDs pitch 20 mm, 2-step MacAdam, 60000h L80 B10 (Ta 25°C)
 2200K: 3-step MacAdam, 60000h L80 B10 (Ta 25°C)

body in black-anodized anticorrosion aluminium
 screen in grey-serigraphed and transparent, tempered extra-clear glass; screen in grey-serigraphed, acid-etched, tempered extra-clear glass (diffuse version)
 caps in technopolymer

built in

recessed (ground)

see p. 164 and 165

optical accessories of honeycomb louvre and anti-glare shield built into the lighting fixture and tiltable together with the optics
 in/out connection and easy wiring with quick connectors designed to connect the profiles in a line

Casambi-compatible version, controllable with the Casambi app, available on request

see p. 809

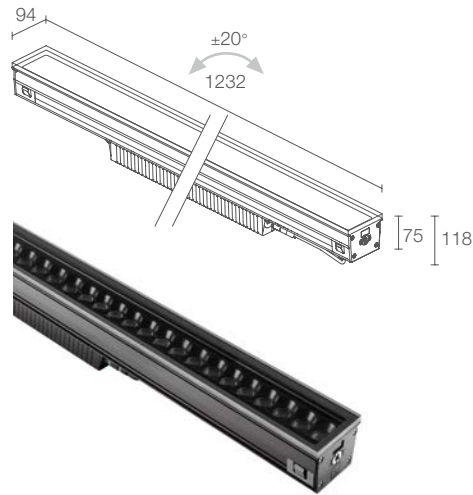

COLORADO 2.2

CE ENEC LED kg 1500 kg 10.6 IP65 IP67 IK10
A **A+** **A++** **PID** $T_{max} 40^{\circ}C$ DALI-2 0/1-10V

83W 230Vac 1232 mm pitch 20
CA22100 ■ **0** ■ **0** ■ **0** ■ **V**

■	0 - on/off 2 - 0/1-10V D - DALI-2
■	0 - none 1 - honeycomb louvre (not compatible with diffuse optics) 2 - anti-glare shield (not compatible with diffuse optics)
■	N - 2200K F - 2700K 5 - 3000K 9 - 4000K
■	S - 12° tiltable ±20° M - 30° tiltable ±20° L - 45° tiltable ±20° K - 76° tiltable ±20° W - 15°x50° tiltable ±20° D - diffuse tiltable ±20°

9900 lm (3000K)

7286 lm (3000K, 12°)

36 high-power LEDs pitch 20 mm, 2-step MacAdam, 60000h L80 B10 (Ta 25°C)
 2200K: 3-step MacAdam, 60000h L80 B10 (Ta 25°C)

body in black-anodized anticorrosion aluminium
 screen in grey-serigraphed and transparent, tempered extra-clear glass; screen in grey-serigraphed, acid-etched, tempered extra-clear glass (diffuse version)
 caps in technopolymer

built in

recessed (ground)

see p. 164 and 165

optical accessories of honeycomb louvre and anti-glare shield built into the lighting fixture and tiltable together with the optics
 in/out connection and easy wiring with quick connectors designed to connect the profiles in a line

Casambi-compatible version, controllable with the Casambi app, available on request

see p. 809

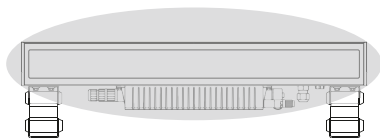

15°x50° optics

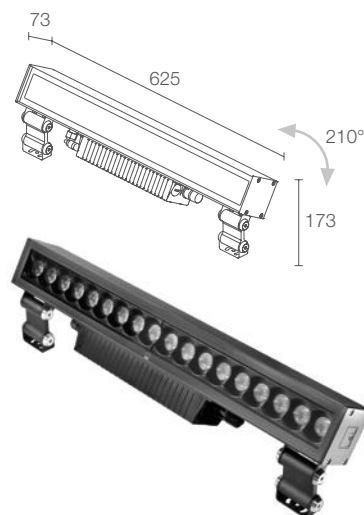

COLORADO 3.0

kg 5.8 IP65 IP67 IK09

 DALI-2 0/1-10V

POWER / POWER SUPPLY CODE	41W 230Vac 625 mm pitch 20 CA30100 ■ O ■ O ■ N Black
CONTROL SYSTEM	0 - on/off 2 - 0/1-10V D - DALI-2
OPTICAL ACCESSORIES	0 - none 1 - honeycomb louvre (not compatible with diffuse optics) 2 - anti-glare shield (not compatible with diffuse optics)
LED COLOUR	N - 2200K F - 2700K 5 - 3000K 9 - 4000K
OPTICS	S - 12° M - 30° L - 45° K - 76° W - 15°x50° D - diffuse

LUMEN OUTPUT AT SOURCE	4950 lm (3000K)
DELIVERED LUMEN OUTPUT	3643 lm (3000K, 12°)
NO. AND TYPE OF LED	18 high-power LEDs pitch 20 mm, 2-step MacAdam, 60000h L80 B10 (Ta 25°C) 2200K: 3-step MacAdam, 60000h L80 B10 (Ta 25°C)
MATERIAL	body in anticorodal aluminium, bracket in stainless steel screen in grey-serigraphed and transparent, tempered extra-clear glass; screen in grey-serigraphed, acid-etched, tempered extra-clear glass (diffuse version) caps in technopolymer
POWER SUPPLY UNIT	built in
MOUNTING	surface mounted (ceiling, wall, ground)
ACCESSORIES	see p. 164 and 165
FEATURES	optical accessories of honeycomb louvre and anti-glare shield built into the lighting fixture two brackets with two pivot points for accurate adjustment
NOTES	Casambi-compatible version, controllable with the Casambi app, available on request
PHOTOMETRIC DATA	see p. 809

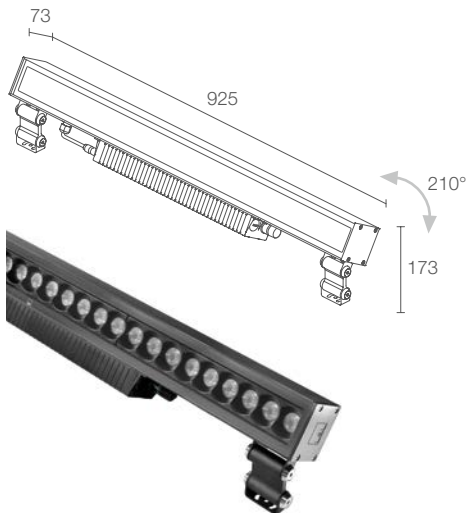

COLORADO 3.1

CE ENEC LED TECH IP65 IP67 IK09
 A A+ A++ PID DALI 0/1-10V

62W 230Vac 925 mm pitch 20
CA31100 ■ O ■ F ■ S ■ N Black

■	0 - on/off 2 - 0/1-10V D - DALI
■	0 - none 1 - honeycomb louvre (not compatible with diffuse optics) 2 - anti-glare shield (not compatible with diffuse optics)
■	N - 2200K F - 2700K S - 3000K 9 - 4000K
■	S - 12° M - 30° L - 45° K - 76° W - 15°x50° D - diffuse

7425 lm (3000K)

5645 lm (3000K, 12°)

27 high-power LEDs pitch 20 mm, 2-step MacAdam, 60000h L80 B10 (Ta 25°C)
 2200K: 3-step MacAdam, 60000h L80 B10 (Ta 25°C)

body in anticorrosion aluminium, bracket in stainless steel
 screen in grey-serigraphed and transparent, tempered
 extra-clear glass; screen in grey-serigraphed, acid-etched,
 tempered extra-clear glass (diffuse version)
 caps in technopolymer

built in

surface mounted (ceiling, wall, ground)

see p. 164 and 165

optical accessories of honeycomb louvre and
 anti-glare shield built into the lighting fixture
 two brackets with two pivot points for accurate
 adjustment

Casambi-compatible version, controllable
 with the Casambi app, available on request

see p. 809

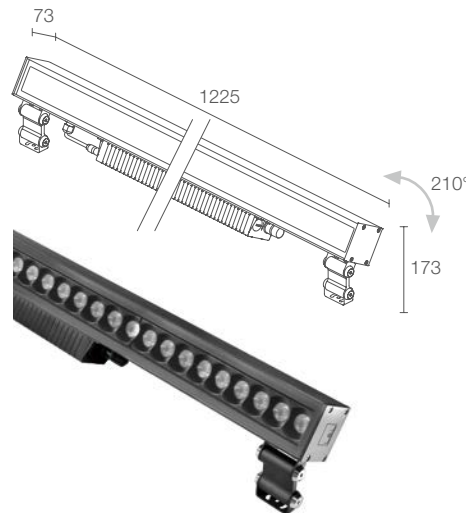

COLORADO 3.2

CE ENEC LED TECH IP65 IP67 IK09
 A A+ A++ PID DALI-2 0/1-10V

83W 230Vac 1225 mm pitch 20
CA32100 ■ O ■ F ■ S ■ N Black

■	0 - on/off 2 - 0/1-10V D - DALI-2
■	0 - none 1 - honeycomb louvre (not compatible with diffuse optics) 2 - anti-glare shield (not compatible with diffuse optics)
■	N - 2200K F - 2700K S - 3000K 9 - 4000K
■	S - 12° M - 30° L - 45° K - 76° W - 15°x50° D - diffuse

9900 lm (3000K)

7286 lm (3000K, 12°)

36 high-power LEDs pitch 20 mm, 2-step MacAdam, 60000h L80 B10 (Ta 25°C)
 2200K: 3-step MacAdam, 60000h L80 B10 (Ta 25°C)

body in anticorrosion aluminium, bracket in stainless steel
 screen in grey-serigraphed and transparent, tempered
 extra-clear glass; screen in grey-serigraphed, acid-etched,
 tempered extra-clear glass (diffuse version)
 caps in technopolymer

built in

surface mounted (ceiling, wall, ground)

see p. 164 and 165

optical accessories of honeycomb louvre and
 anti-glare shield built into the lighting fixture
 two brackets with two pivot points for accurate
 adjustment

Casambi-compatible version, controllable
 with the Casambi app, available on request

see p. 809



Black

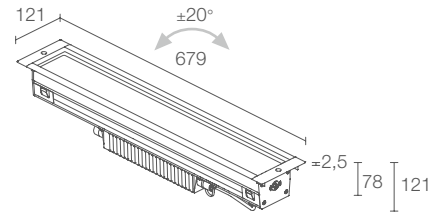

Rebated
installation



COLORADO 4.0



IP65 IP67 IK10 DMX RDM

A A+ A++ PID T max 40°C

POWER / POWER SUPPLY CODE 43W 230Vac 679 mm pitch 20
CA4010040070 ■ N Anodized black

OPTICS
S - 15° tiltable ±20°
M - 25° tiltable ±20°
L - 37° tiltable ±20°
W - 13°x65° tiltable ±20°

LED COLOUR RGBW

LUMEN OUTPUT AT SOURCE	R: 1337 lm G: 2880 lm B: 350 lm W: 2469 lm (3000K)
DELIVERED LUMEN OUTPUT	2547 lm R: 852 lm G: 1526 lm B: 360 lm W: 1836 lm (3000K, 15°)
NO. AND TYPE OF LED	12 multicolour high-intensity power LEDs pitch 20 mm 60000h L80 B10 (Ta 25° C)
MATERIAL	body in black-anodized anticorodal aluminium screen in grey-serigraphed and transparent, tempered extra-clear glass caps in technopolymer
POWER SUPPLY UNIT	built in
MOUNTING	recessed (ground)
ACCESSORIES	see p. 164 and 165
FEATURES	in/out connection and easy wiring with quick connectors designed to connect the profiles in a line
NOTES	Casambi-compatible version, controllable with the Casambi app, available on request
PHOTOMETRIC DATA	see p. 810

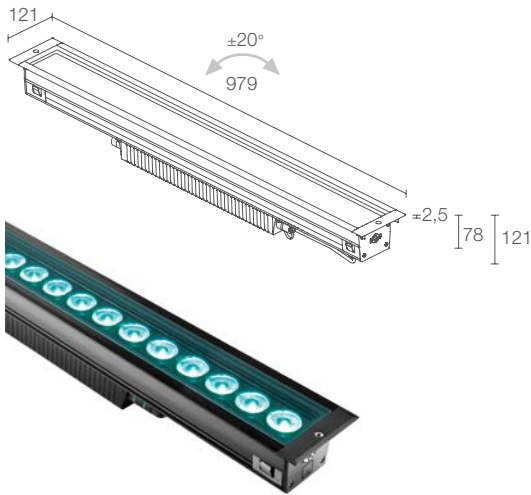

COLORADO 4.1

IP65 IP67 IK10 DMX RDM
 A A+ A++ PID T max 40°C

64W 230Vac 979 mm pitch 20
CA4110040070 ■ N Anodized black

■ S - 15° tiltable ±20°
 M - 25° tiltable ±20°
 L - 37° tiltable ±20°
 W - 13°x65° tiltable ±20°

RGBW

R: 2003 lm G: 4320 lm B: 525 lm W: 3703 lm (3000K)

3820 lm
 R: 2003 lm G: 4320 lm B: 525 lm W: 3703 lm (3000K, 15°)

18 multicolour high-intensity power LEDs pitch 20 mm 60000h L80 B10 (Ta 25° C)

body in black-anodized anticorrosional aluminium
 screen in grey-serigraphed and transparent,
 tempered extra-clear glass
 caps in technopolymer

built in

recessed (ground)

see p. 164 and 165

in/out connection and easy wiring with quick connectors designed to connect the profiles in a line

Casambi-compatible version, controllable with the Casambi app, available on request

see p. 810

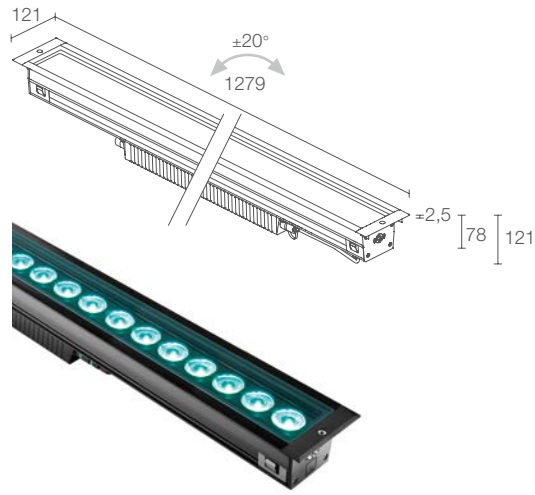

COLORADO 4.2

IP65 IP67 IK10 DMX RDM
 A A+ A++ PID T max 40°C

85W 230Vac 1279 mm pitch 20
CA4210040070 ■ N Anodized black

■ S - 15° tiltable ±20°
 M - 25° tiltable ±20°
 L - 37° tiltable ±20°
 W - 13°x65° tiltable ±20°

RGBW

R: 2674 lm G: 5760 lm B: 700 lm W: 4967 lm (3000K)

5104 lm
 R: 2674 lm G: 5760 lm B: 700 lm W: 4967 lm (3000K, 15°)

24 multicolour high-intensity power LEDs pitch 20 mm 60000h L80 B10 (Ta 25° C)

body in black-anodized anticorrosional aluminium
 screen in grey-serigraphed and transparent,
 tempered extra-clear glass
 caps in technopolymer

built in

recessed (ground)

see p. 164 and 165

in/out connection and easy wiring with quick connectors designed to connect the profiles in a line

Casambi-compatible version, controllable with the Casambi app, available on request

see p. 810

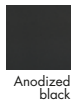

Anodized black

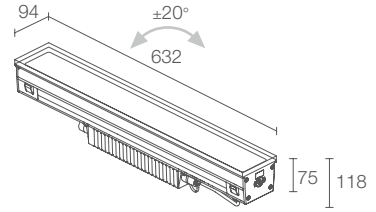

Installation flush
with ground

COLORADO 5.0

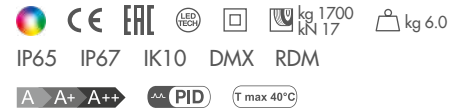

POWER / POWER SUPPLY CODE	43W 230Vac 632 mm pitch 20 CA5010040070 ■ V
OPTICS	S - 15° tiltable ±20° M - 25° tiltable ±20° L - 37° tiltable ±20° W - 13°x65° tiltable ±20°
LED COLOUR	RGBW
LUMEN OUTPUT AT SOURCE	R: 1337 lm G: 2880 lm B: 350 lm W: 2469 lm (3000K)
DELIVERED LUMEN OUTPUT	2547 lm R: 852 lm G: 1526 lm B: 360 lm W: 1836 lm (3000K, 15°)
NO. AND TYPE OF LED	12 multicolour high-intensity power LEDs pitch 20 mm 60000h L80 B10 (Ta 25° C)
MATERIAL	body in black-anodized anticorrosional aluminium screen in grey-serigraphed and transparent, tempered extra-clear glass caps in technopolymer
POWER SUPPLY UNIT	built in
MOUNTING	recessed (ground)
ACCESSORIES	see p. 164 and 165
FEATURES	in/out connection and easy wiring with quick connectors designed to connect the profiles in a line
NOTES	Casambi-compatible version, controllable with the Casambi app, available on request
PHOTOMETRIC DATA	see p. 810

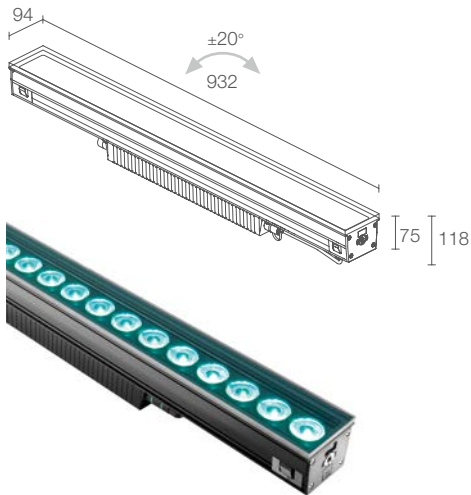

COLORADO 5.1



IP65 IP67 IK10 DMX RDM

A A+ A++ PID T max 40°C

64W 230Vac 932 mm pitch 20
CA5110040070 ■ V

- **S** - 15° tiltable ±20°
- M** - 25° tiltable ±20°
- L** - 37° tiltable ±20°
- W** - 13°x65° tiltable ±20°

RGBW

R: 2003 lm G: 4320 lm B: 525 lm W: 3703 lm
 (3000K)

3820 lm
 R: 2003 lm G: 4320 lm B: 525 lm W: 3703 lm
 (3000K, 15°)

18 multicolour high-intensity power LEDs pitch 20 mm
 60000h L80 B10 (Ta 25° C)

body in black-anodized anticorrosional aluminium
 screen in grey-serigraphed and transparent,
 tempered extra-clear glass
 caps in technopolymer

built in

recessed (ground)

see p. 164 and 165

in/out connection and easy wiring with quick
 connectors designed to connect the profiles in a line

Casambi-compatible version, controllable
 with the Casambi app, available on request

see p. 810

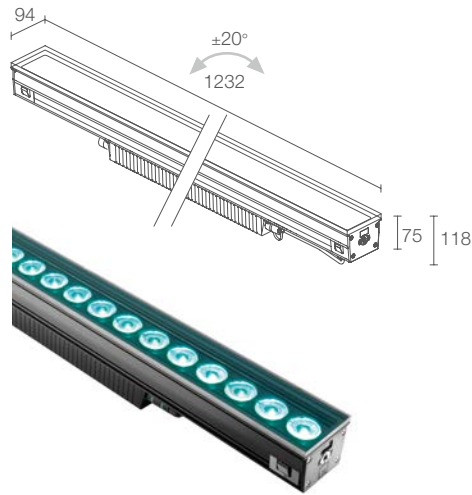

COLORADO 5.2



IP65 IP67 IK10 DMX RDM

A A+ A++ PID T max 40°C

85W 230Vac 1232 mm pitch 20
CA5210040070 ■ V

- **S** - 15° tiltable ±20°
- M** - 25° tiltable ±20°
- L** - 37° tiltable ±20°
- W** - 13°x65° tiltable ±20°

RGBW

R: 2674 lm G: 5760 lm B: 700 lm W: 4967 lm
 (3000K)

5104 lm
 R: 2674 lm G: 5760 lm B: 700 lm W: 4967 lm
 (3000K, 15°)

24 multicolour high-intensity power LEDs pitch 20 mm
 60000h L80 B10 (Ta 25° C)

body in black-anodized anticorrosional aluminium
 screen in grey-serigraphed and transparent,
 tempered extra-clear glass
 caps in technopolymer

built in

recessed (ground)

see p. 164 and 165

in/out connection and easy wiring with quick
 connectors designed to connect the profiles in a line

Casambi-compatible version, controllable
 with the Casambi app, available on request

see p. 810

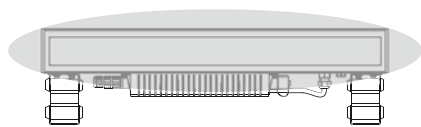

13°x65° optics

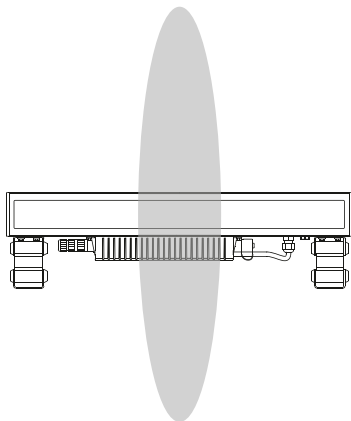

65°x13° optics

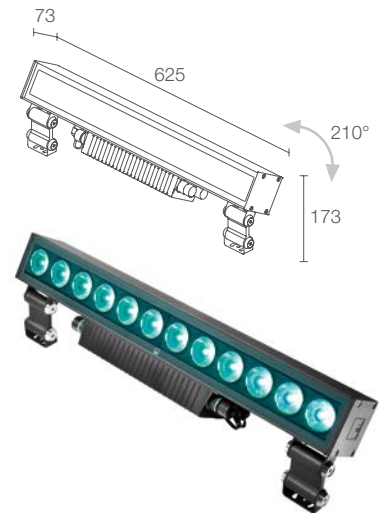

COLORADO 6.0



POWER / POWER SUPPLY CODE

43W 230Vac 625 mm pitch 20
CA6010040070 ■ N Black

OPTICS

S - 15°
M - 25°
L - 37°
W - 13°x65°
X - 65°x13°

LED COLOUR

RGBW

LUMEN OUTPUT AT SOURCE R: 1337 lm G: 2880 lm B: 350 lm W: 2469 lm (3000K)

DELIVERED LUMEN OUTPUT 2547 lm
 R: 852 lm G: 1526 lm B: 360 lm W: 1836 lm (3000K, 15°)

NO. AND TYPE OF LED 12 multicolour high-intensity power LEDs pitch 20 mm 60000h L80 B10 (Ta 25° C)

MATERIAL body in anticorodal aluminium, bracket in stainless steel screen in grey-serigraphed and transparent, tempered extra-clear glass caps in technopolymer

POWER SUPPLY UNIT built in

MOUNTING surface mounted (ceiling, wall, ground)

ACCESSORIES see p. 164 and 165

FEATURES two brackets with two pivot points for accurate adjustment

NOTES Casambi-compatible version, controllable with the Casambi app, available on request

PHOTOMETRIC DATA see p. 810



COLORADO 6.1



IP65 IP67 IK09 DMX RDM



64W 230Vac 925 mm pitch 20
CA6110040070 ■ N Black

■ **S** - 15°
M - 25°
L - 37°
W - 13°x65°
X - 65°x13°

RGBW

R: 2003 lm G: 4320 lm B: 525 lm W: 3703 lm
 (3000K)

3820 lm
 R: 2003 lm G: 4320 lm B: 525 lm W: 3703 lm
 (3000K, 15°)

18 multicolour high-intensity power LEDs pitch 20 mm
 60000h L80 B10 (Ta 25° C)

body in anticorodal aluminium, bracket in stainless
 steel screen in grey-serigraphed and transparent,
 tempered extra-clear glass
 caps in technopolymer

built in

surface mounted (ceiling, wall, ground)

see p. 164 and 165

two brackets with two pivot points for accurate adjustment

Casambi-compatible version, controllable with the
 Casambi app, available on request

see p. 810

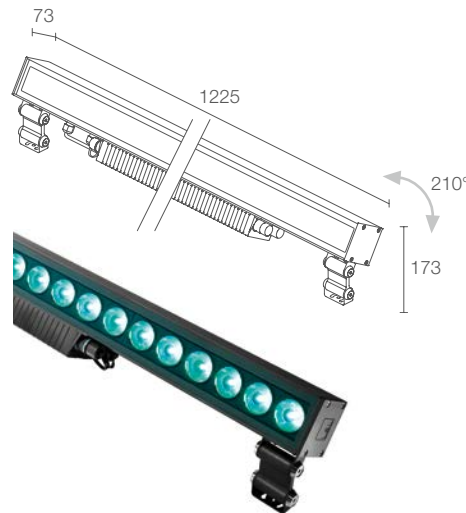

COLORADO 6.2



IP65 IP67 IK09 DMX RDM



85W 230Vac 1225 mm pitch 20
CA6210040070 ■ N Black

■ **S** - 15°
M - 25°
L - 37°
W - 13°x65°
X - 65°x13°

RGBW

R: 2674 lm G: 5760 lm B: 700 lm W: 4967 lm
 (3000K)

5104 lm
 R: 2674 lm G: 5760 lm B: 700 lm W: 4967 lm
 (3000K, 15°)

24 multicolour high-intensity power LEDs pitch 20 mm
 60000h L80 B10 (Ta 25° C)

body in anticorodal aluminium, bracket in stainless
 steel screen in grey-serigraphed and transparent,
 tempered extra-clear glass
 caps in technopolymer

built in

surface mounted (ceiling, wall, ground)

see p. 164 and 165

two brackets with two pivot points for accurate adjustment

Casambi-compatible version, controllable with the
 Casambi app, available on request

see p. 810



Black

**ACCESSORIES
FOR INSTALLATION**



Outer casing

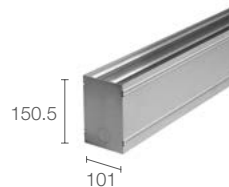

Outer casing

COLORADO 1.0	WCCA10AOT - 668.5 mm
COLORADO 1.1	WCCA11AOT - 968.5 mm
COLORADO 1.2	WCCA12AOT - 1268.5 mm
COLORADO 2.0	WCCA20AOF - 636.5 mm
COLORADO 2.1	WCCA21AOF - 936.5 mm
COLORADO 2.2	WCCA22AOF - 1236.5 mm
COLORADO 4.0	WCCA10AOT - 668.5 mm
COLORADO 4.1	WCCA11AOT - 968.5 mm
COLORADO 4.2	WCCA12AOT - 1268.5 mm
COLORADO 5.0	WCCA20AOF - 636.5 mm
COLORADO 5.1	WCCA21AOF - 936.5 mm
COLORADO 5.2	WCCA22AOF - 1236.5 mm

√
COLORADO 5.0
RGBW, 43W, 37°

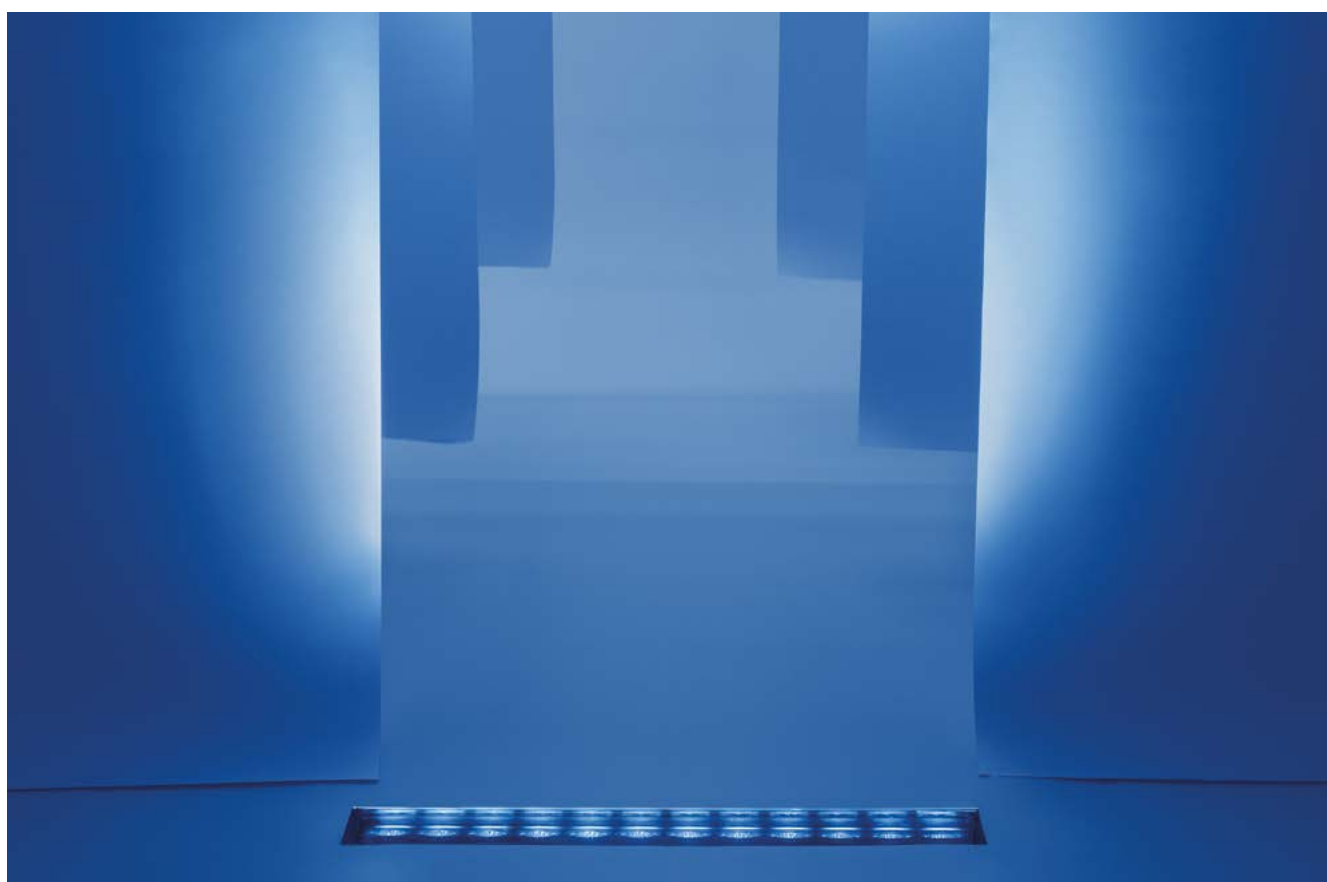

ACCESSORIES

ACCESSORIES FOR INSTALLATION



WMA04N
Brackets adjustable from 0 to 150 mm
(Colorado 3 / 6)



WFA01
4-pin male connector
for IP68 in/out connection
(0/1-10V or DALI version)



WFA05
5-pin male connector
for IP68 in/out connection



WFA0005
5-m, 4-pin interconnect cable
for DALI or 0/1-10V version
(Colorado 1 / 2 / 3)



WFA0001
1.5-m, 3-pin interconnect cable
for DMX version
(Colorado 4 / 5 / 6)



WFA0101
1.5-m, 4-pin interconnect cable
for DALI or 0/1-10V version
(Colorado 1 / 2 / 3)



WFA0105
5-m, 3-pin interconnect cable
for DMX signal
(Colorado 4 / 5 / 6)



WFA0201
1.5-m, 5-pin interconnect cable
(Colorado 1 / 2 / 3)



WFA0205
5-m, 5-pin interconnect cable
(Colorado 1 / 2 / 3)

for spare parts, see p. 934



< TAGO 2.3
2200K, 51W, 29°

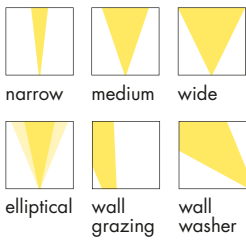

RECESSED,
WITH REBATED FRAME

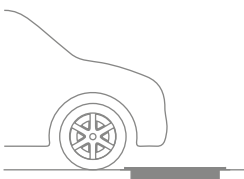

TAGO 1.0 p. 170
14W 230Vac
ON/OFF, DALI, 0/1-10V
322 mm



TAGO 1.1 p. 171
24W 230Vac
ON/OFF, DALI, 0/1-10V
572 mm



TAGO 1.3 p. 171
51W 230Vac
ON/OFF, DALI, 0/1-10V
1072 mm

RECESSED FLUSH,
WITHOUT FRAME

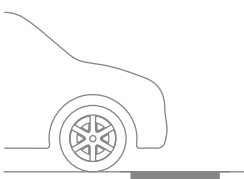

TAGO 2.0 p. 172
14W 230Vac
ON/OFF, DALI, 0/1-10V
279 mm



TAGO 2.1 p. 173
24W 230Vac
ON/OFF, DALI, 0/1-10V
529 mm



TAGO 2.3 p. 173
51W 230Vac
ON/OFF, DALI, 0/1-10V
1029 mm

SURFACE MOUNTED,
WITH BRACKETS



TAGO 3.0 p. 174
14W 230Vac
ON/OFF, DALI, 0/1-10V
286 mm



TAGO 3.1 p. 175
24W 230Vac
ON/OFF, DALI, 0/1-10V
536 mm



TAGO 3.3 p. 175
51W 230Vac
ON/OFF, DALI, 0/1-10V
1036 mm

OUTDOOR LINEAR PROFILES ARCHITECTURAL LIGHTING FOR FACADES



RGBW



TAGO 4.0 p. 176
14W 48Vdc
DMX512, RDM
322 mm



RGBW



TAGO 4.1 p. 177
24W 48Vdc / 29W 230Vac
DMX512, RDM
572 mm



RGBW



TAGO 4.3 p. 177
49W 48Vdc / 55W 230Vac
DMX512, RDM
1072 mm



TAGO 5.0 p. 178
14W 48Vdc
DMX512, RDM
279 mm



TAGO 5.1 p. 179
24W 48Vdc / 29W 230Vac
DMX512, RDM
529 mm



TAGO 5.3 p. 179
49W 48Vdc / 55W 230Vac
DMX512, RDM
1029 mm



TAGO 6.0 p. 180
14W 48Vdc
DMX512, RDM
286 mm



TAGO 6.1 p. 181
24W 48Vdc / 29W 230Vac
DMX512, RDM
536 mm



TAGO 6.3 p. 181
49W 48Vdc / 55W 230Vac
DMX512, RDM
1036 mm

11°

17°

29°

69°

20°x49°

wall washer

wall grazing

**IP65 / IP67**

SUITABLE FOR OUTDOOR APPLICATIONS



BUILT-IN PROTECTION SYSTEMS:

IPS

INTELLIGENT PROTECTION SYSTEM

**PID**

PROTECTIVE IMPEDANCE DEVICE



BUILT-IN

230

Vac

POWER SUPPLY UNIT



TAGO 1 / 2 / 3

AVAILABLE IN DALI AND

0/1-10V DIMMABLE VERSIONS



TAGO 4 / 5 / 6

LIGHTING CONTROLLED USING
THE DMX512+RDM PROTOCOL

TAGO 1 / 2 / 3

ANTI-GLARE RECESSED OPTICS
TO ENSURE VISUAL COMFORT**IK09**UP-TO-10-MM-THICK, TEMPERED EXTRA-CLEAR
GLASS WITH GREY-VITRIFIED SERIGRAPHY,
HIGH-TRANSMITTANCE TO ENSURE CHROMATIC
HOMOGENEITY, AND EXCELLENT RESISTANCE
TO KNOCKS AND SCRATCHESBODY MADE OF ANTICORODAL LOW-COPPER-CONTENT
ALUMINIUM EN AW 6060 T5 FOR EXCELLENT
HEAT DISSIPATION, MANUFACTURED
FROM AN EXTRUDED PROFILE AND
SUBSEQUENTLY ELECTRO-COLOURED
DEEP BLACK OR PAINTED BLACK FOR
EXCELLENT RESISTANCE TO CORROSION

TAGO 1 / 2 / 4 / 5

DRIVE-OVER UP TO 2000 KG

<

TAGO 1

PROFILE CENTRE DISTANCE FROM WALL

WALL WASHER OPTICS: 50 CM

OTHER OPTICS: 20 CM

UNIQUE SELLING POINTS



RGBW
VERSION

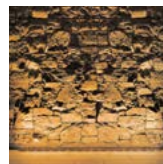

AVAILABLE WITH 2200K
LED COLOUR



TAGO 1 / 2 TILTING SYSTEM INSIDE THE OPTICAL UNIT

The light direction can be altered by $\pm 20^\circ$ externally with a simple adjustment on the end caps, without compromising the fixture's IP65/IP67 protection level.



TAGO 3 / 6 THE BRACKET WITH TWO PIVOT POINTS ALLOWS THE LIGHT OUTPUT TO BE PRECISELY DIRECTED



IN/OUT CONNECTION

Easy wiring with quick connectors designed to connect the profiles in a line in the dimmable versions.



TAGO 1 / 2 / 3
ANTI-GLARE ACCESSORIES.
THE HONEYCOMB LOUVRE OR
ANTI-GLARE SHIELD, WHICH
CAN BE ORDERED AT THE
SAME TIME AS THE FIXTURE,
IS MOUNTED ON THE OPTICAL
UNIT, SO THAT THE CHOSEN
OPTION TILTS TOGETHER
WITH THE OPTICS IN
THE RECESSED VERSION



Rebated
installation

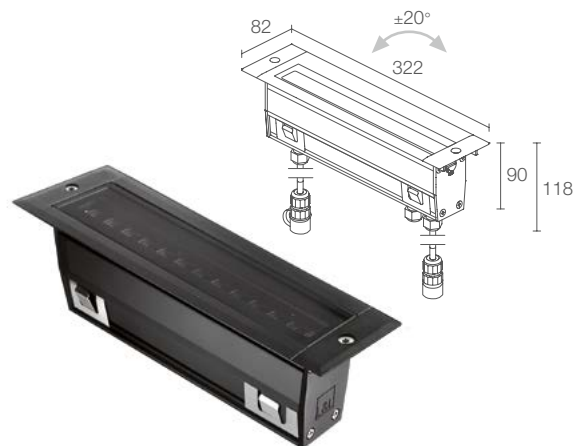

TAGO 1.0

On/off version: 1 cable gland
DALI, 0/1-10V version: 3 cable glands, 2 connectors

CE ENEC kg 2000 kg 1.324 IP65 IP67 IK09
A A+ A++ T max 40°C DALI 0/1-10V

POWER / POWER SUPPLY CODE	14W 230Vac 322 mm pitch 20 TG10100 ■ 0 ■ 0 ■ N Anodized black
CONTROL SYSTEM	0 - on/off 2 - 0/1-10V D - DALI
OPTICAL ACCESSORIES	0 - none 1 - honeycomb louvre (not compatible with 11°, 17°, wall grazing and wall washer optics) 2 - anti-glare shield (not compatible with 11°, wall grazing and wall washer optics)
LED COLOUR	N - 2200K F - 2700K 5 - 3000K 9 - 4000K
OPTICS	S - 11° tiltable ±20° M - 17° tiltable ±20° L - 29° tiltable ±20° K - 69° tiltable ±20° W - 20°x49° tiltable ±20° G - wall grazing tiltable ±20° A - wall washer tiltable ±20°

LUMEN OUTPUT AT SOURCE	1492 lm (3000K)
DELIVERED LUMEN OUTPUT	932 lm (3000K, 29°)
NO. AND TYPE OF LED	12 SMD LEDs, pitch 20 mm, 2-step MacAdam, 60000h L80 B10 (Ta 25°C) 2200K: 3-step MacAdam, 60000h L80 B10 (Ta 25°C)
MATERIAL	body in black-anodized anticorrosional aluminium screen in grey-serigraphed and transparent, tempered extra-clear glass; screen in grey-serigraphed, acid-etched, tempered extra-clear glass (wall-washer optics) caps in technopolymer
POWER SUPPLY UNIT	built in
POWER CABLES	on/off: includes 1.5 m neoprene cable H07RN-F 3x1.0 Ø9.3 mm; DALI, 0/1-10V: includes 1x1.5 m neoprene cable H07RN-F 3x1.0 Ø9.3 mm and 2x0.75 m neoprene cables H05RN-F 2x1.0 Ø6.7 mm
MOUNTING	recessed (ground)
ACCESSORIES	see p. 182 and 183
FEATURES	in/out connection and easy wiring with quick connectors designed to connect the profiles in a line in the dimmable versions; anti-glare accessories, honeycomb louvre and anti-glare shield, built into the lighting fixture and tiltable together with the optics
NOTES	Casambi-compatible version, controllable with the Casambi app, available on request
PHOTOMETRIC DATA	see p. 891

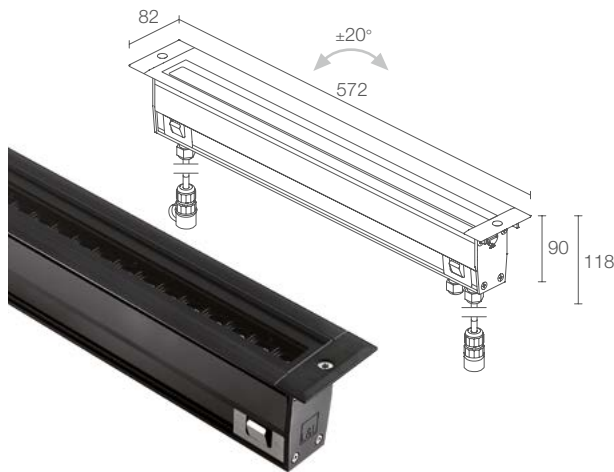

TAGO 1.1

On/off version: 1 cable gland
DALI, 0/1-10V version: 3 cable glands, 2 connectors

CE ENEC IEC kg 2000 kN 20 kg 2.104 IP65 IP67 IK09
A A+ A++ IPS PID T max 40°C DALI 0/1-10V

24W 230Vac 572 mm pitch 20

TG11100 ■ 0 ■ 0 ■ N Anodized black

■	0 - on/off 2 - 0/1-10V D - DALI
■	0 - none 1 - honeycomb louvre (not compatible with 11°, 17°, wall grazing and wall washer optics) 2 - anti-glare shield (not compatible with 11°, wall grazing and wall washer optics)
■	N - 2200K F - 2700K 5 - 3000K 9 - 4000K
■	S - 11° tiltable ±20° M - 17° tiltable ±20° L - 29° tiltable ±20° K - 69° tiltable ±20° W - 20°x49° tiltable ±20° G - wall grazing tiltable ±20° A - wall washer tiltable ±20°

2984 lm (3000K)

1864 lm (3000K, 29°)

24 SMD LEDs, pitch 20 mm, 2-step MacAdam,
60000h L80 B10 (Ta 25°C)
2200K: 3-step MacAdam, 60000h L80 B10 (Ta 25°C)

body in black-anodized anticorrosional aluminium
screen in grey-serigraphed and transparent, tempered
extra-clear glass; screen in grey-serigraphed, acid-etched,
tempered extra-clear glass (wall-washer optics)
caps in technopolymer

built in

on/off: includes 1.5 m neoprene cable H07RN-F
3x1.0 Ø9.3 mm; DALI, 0/1-10V: includes 1x1.5 m
neoprene cable H07RN-F 3x1.0 Ø9.3 mm and
2x0.75 m neoprene cables H05RN-F 2x1.0 Ø6.7 mm

recessed (ground)

see p. 182 and 183

in/out connection and easy wiring with quick connectors
designed to connect the profiles in a line in the dimmable
versions; anti-glare accessories, honeycomb louvre and
anti-glare shield, built into the lighting fixture and tiltable
together with the optics

Casambi-compatible version, controllable with
the Casambi app, available on request

see p. 891

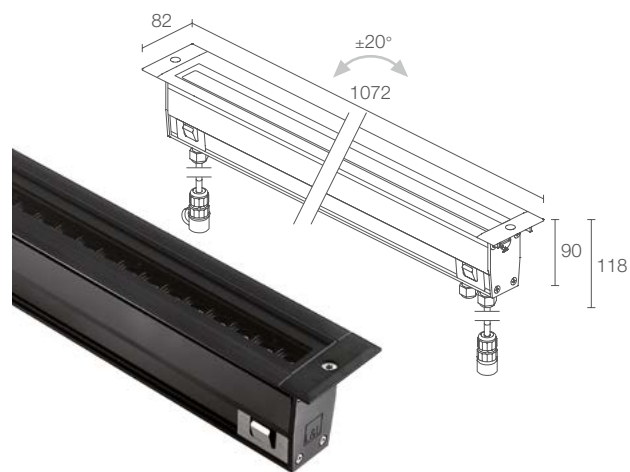

TAGO 1.3

On/off version: 1 cable gland
DALI, 0/1-10V version: 3 cable glands, 2 connectors

CE ENEC IEC kg 2000 kN 20 kg 4.082 IP65 IP67 IK09
A A+ A++ IPS PID T max 40°C DALI 0/1-10V

51W 230Vac 1072 mm pitch 20

TG13100 ■ 0 ■ 0 ■ N Anodized black

■	0 - on/off 2 - 0/1-10V D - DALI
■	0 - none 1 - honeycomb louvre (not compatible with 11°, 17°, wall grazing and wall washer optics) 2 - anti-glare shield (not compatible with 11°, wall grazing and wall washer optics)
■	N - 2200K F - 2700K 5 - 3000K 9 - 4000K
■	S - 11° tiltable ±20° M - 17° tiltable ±20° L - 29° tiltable ±20° K - 69° tiltable ±20° W - 20°x49° tiltable ±20° G - wall grazing tiltable ±20° A - wall washer tiltable ±20°

5968 lm (3000K)

3728 lm (3000K, 29°)

48 SMD LEDs, pitch 20 mm, 2-step MacAdam,
60000h L80 B10 (Ta 25°C)
2200K: 3-step MacAdam, 60000h L80 B10 (Ta 25°C)

body in black-anodized anticorrosional aluminium
screen in grey-serigraphed and transparent, tempered
extra-clear glass; screen in grey-serigraphed, acid-etched,
tempered extra-clear glass (wall-washer optics)
caps in technopolymer

built in

on/off: includes 1.5 m neoprene cable H07RN-F
3x1.0 Ø9.3 mm; DALI, 0/1-10V: includes 1x1.5 m
neoprene cable H07RN-F 3x1.0 Ø9.3 mm and
2x0.75 m neoprene cables H05RN-F 2x1.0 Ø6.7 mm

recessed (ground)

see p. 182 and 183

in/out connection and easy wiring with quick connectors
designed to connect the profiles in a line in the dimmable
versions; anti-glare accessories, honeycomb louvre and
anti-glare shield, built into the lighting fixture and tiltable
together with the optics

Casambi-compatible version, controllable with
the Casambi app, available on request

see p. 891





Installation flush
with ground

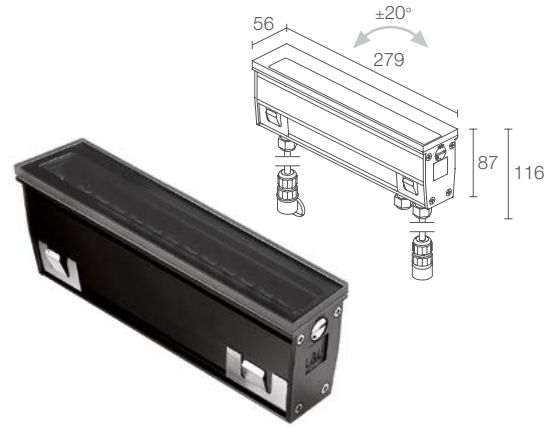

TAGO 2.0

On/off version: 1 cable gland
DALI, 0/1-10V version: 3 cable glands, 2 connectors

✓
TAGO 2.0
3000K, 14W, 29°, with honeycomb louvre

CE ENEC kg 2000 kg 1.16 IP65 IP67 IK09
A A+ A++ DALI 0/1-10V



POWER / POWER SUPPLY CODE	14W 230Vac 279 mm pitch 20 TG20100 ■ 0 ■ 0 ■ 0 ■ V
CONTROL SYSTEM	0 - on/off 2 - 0/1-10V D - DALI
OPTICAL ACCESSORIES	0 - none 1 - honeycomb louvre (not compatible with 11°, 17°, wall grazing and wall washer optics) 2 - anti-glare shield (not compatible with 11°, wall grazing and wall washer optics)
LED COLOUR	N - 2200K F - 2700K 5 - 3000K 9 - 4000K
OPTICS	S - 11° tiltable ±20° M - 17° tiltable ±20° L - 29° tiltable ±20° K - 69° tiltable ±20° W - 20°x49° tiltable ±20° G - wall grazing tiltable ±20° A - wall washer tiltable ±20°
LUMEN OUTPUT AT SOURCE	1492 lm (3000K)
DELIVERED LUMEN OUTPUT	932 lm (3000K, 29°)
NO. AND TYPE OF LED	12 SMD LEDs, pitch 20 mm, 2-step MacAdam, 60000h L80 B10 (Ta 25°C) 2200K: 3-step MacAdam, 60000h L80 B10 (Ta 25°C)
MATERIAL	body in black-anodized anticorrosion aluminium screen in grey-serigraphed and transparent, tempered extra-clear glass; screen in grey-serigraphed, acid-etched, tempered extra-clear glass (wall-washer optics) caps in technopolymer
POWER SUPPLY UNIT	built in
POWER CABLES	on/off: includes 1.5 m neoprene cable H07RN-F 3x1.0 Ø9.3 mm; DALI, 0/1-10V: includes 1x1.5 m neoprene cable H07RN-F 3x1.0 Ø9.3 mm and 2x0.75 m neoprene cables H05RN-F 2x1.0 Ø6.7 mm
MOUNTING	recessed (ground)
ACCESSORIES	see p. 182 and 183
FEATURES	in/out connection and easy wiring with quick connectors designed to connect the profiles in a line in the dimmable versions; anti-glare accessories, honeycomb louvre and anti-glare shield, built into the lighting fixture and tiltable together with the optics
NOTES	Casambi-compatible version, controllable with the Casambi app, available on request
PHOTOMETRIC DATA	see p. 891



TAGO 2.1

On/off version: 1 cable gland
DALI, 0/1-10V version: 3 cable glands, 2 connectors

CE ENEC kg 2000 kN 20 kg 1.848 IP65 IP67 IK09
A A+ A++ DALI 0/1-10V

24W 230Vac 529 mm pitch 20
TG21100 ■ 0 ■ ■ 0 ■ V

■	0 - on/off 2 - 0/1-10V D - DALI
■	0 - none 1 - honeycomb louvre (not compatible with 11°, 17°, wall grazing and wall washer optics) 2 - anti-glare shield (not compatible with 11°, wall grazing and wall washer optics)
■	N - 2200K F - 2700K 5 - 3000K 9 - 4000K
■	S - 11° tiltable ±20° M - 17° tiltable ±20° L - 29° tiltable ±20° K - 69° tiltable ±20° W - 20°x49° tiltable ±20° G - wall grazing tiltable ±20° A - wall washer tiltable ±20°

2984 lm (3000K)

1864 lm (3000K, 29°)

24 SMD LEDs, pitch 20 mm, 2-step MacAdam, 60000h L80 B10 (Ta 25°C)
2200K: 3-step MacAdam, 60000h L80 B10 (Ta 25°C)

body in black-anodized anticorrosion aluminium
screen in grey-serigraphed and transparent, tempered extra-clear glass; screen in grey-serigraphed, acid-etched, tempered extra-clear glass (wall-washer optics)
caps in technopolymer

built in

on/off: includes 1.5 m neoprene cable HO7RN-F 3x1.0 Ø9.3 mm; DALI, 0/1-10V: includes 1x1.5 m neoprene cable HO7RN-F 3x1.0 Ø9.3 mm and 2x0.75 m neoprene cables HO5RN-F 2x1.0 Ø6.7 mm

recessed (ground)

see p. 182 and 183

in/out connection and easy wiring with quick connectors designed to connect the profiles in a line in the dimmable versions; anti-glare accessories, honeycomb louvre and anti-glare shield, built into the lighting fixture and tiltable together with the optics

Casambi-compatible version, controllable with the Casambi app, available on request

see p. 891



TAGO 2.3

On/off version: 1 cable gland
DALI, 0/1-10V version: 3 cable glands, 2 connectors

CE ENEC kg 2000 kN 20 kg 3.658 IP65 IP67 IK09
A A+ A++ DALI 0/1-10V

51W 230Vac 1029 mm pitch 20
TG23100 ■ 0 ■ ■ 0 ■ V

■	0 - on/off 2 - 0/1-10V D - DALI
■	0 - none 1 - honeycomb louvre (not compatible with 11°, 17°, wall grazing and wall washer optics) 2 - anti-glare shield (not compatible with 11°, wall grazing and wall washer optics)
■	N - 2200K F - 2700K 5 - 3000K 9 - 4000K
■	S - 11° tiltable ±20° M - 17° tiltable ±20° L - 29° tiltable ±20° K - 69° tiltable ±20° W - 20°x49° tiltable ±20° G - wall grazing tiltable ±20° A - wall washer tiltable ±20°

5968 lm (3000K)

3728 lm (3000K, 29°)

48 SMD LEDs, pitch 20 mm, 2-step MacAdam, 60000h L80 B10 (Ta 25°C)
2200K: 3-step MacAdam, 60000h L80 B10 (Ta 25°C)

body in black-anodized anticorrosion aluminium
screen in grey-serigraphed and transparent, tempered extra-clear glass; screen in grey-serigraphed, acid-etched, tempered extra-clear glass (wall-washer optics)
caps in technopolymer

built in

on/off: includes 1.5 m neoprene cable HO7RN-F 3x1.0 Ø9.3 mm; DALI, 0/1-10V: includes 1x1.5 m neoprene cable HO7RN-F 3x1.0 Ø9.3 mm and 2x0.75 m neoprene cables HO5RN-F 2x1.0 Ø6.7 mm

recessed (ground)

see p. 182 and 183

in/out connection and easy wiring with quick connectors designed to connect the profiles in a line in the dimmable versions; anti-glare accessories, honeycomb louvre and anti-glare shield, built into the lighting fixture and tiltable together with the optics

Casambi-compatible version, controllable with the Casambi app, available on request

see p. 891

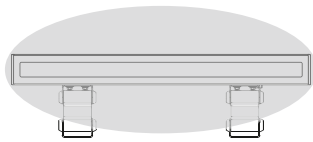

20°x49° optics



TAGO 3.0

On/off version: 1 cable gland
DALI, 0/1-10V version: 3 cable glands, 2 connectors

CE ENEC LED TECH kg 1.083 IP65 IP67 IK09
A A+ A++ IPS PID DALI 0/1-10V

POWER / POWER SUPPLY CODE	14W 230Vac 286 mm pitch 20 TG30100 ■ 0 ■ 0 ■ N Black
CONTROL SYSTEM	0 - on/off 2 - 0/1-10V D - DALI
OPTICAL ACCESSORIES	0 - none 1 - honeycomb louvre (not compatible with 11°, 17°, wall grazing and wall washer optics) 2 - anti-glare shield (not compatible with 11°, wall grazing and wall washer optics)
LED COLOUR	N - 2200K F - 2700K 5 - 3000K 9 - 4000K
OPTICS	S - 11° M - 17° L - 29° K - 69° W - 20°x49° G - wall grazing A - wall washer

LUMEN OUTPUT AT SOURCE	1492 lm (3000K)
DELIVERED LUMEN OUTPUT	932 lm (3000K, 29°)
NO. AND TYPE OF LED	12 SMD LEDs, pitch 20 mm, 2-step MacAdam, 60000h L80 B10 (Ta 25°C) 2200K: 3-step MacAdam, 60000h L80 B10 (Ta 25°C)
MATERIAL	body in anticorrosional aluminium; bracket in stainless steel screen in grey-serigraphed and transparent, tempered extra-clear glass; screen in grey-serigraphed, acid-etched, tempered extra-clear glass (wall-washer optics) caps in die-cast aluminium
POWER SUPPLY UNIT	built in
POWER CABLES	on/off: includes 1.5 m neoprene cable H07RN-F 3x1.0 Ø9.3 mm; DALI, 0/1-10V: includes 1x1.5 m neoprene cable H07RN-F 3x1.0 Ø9.3 mm and 2x0.75 m neoprene cables H05RN-F 2x1.0 Ø6.7 mm
MOUNTING	surface mounted (ceiling, wall, ground)
ACCESSORIES	see p. 182 and 183
FEATURES	central bracket with two pivot points for accurate adjustment; anti-glare accessories, honeycomb louvre and anti-glare shield, built into the lighting fixture
NOTES	Casambi-compatible version, controllable with the Casambi app, available on request
PHOTOMETRIC DATA	see p. 891

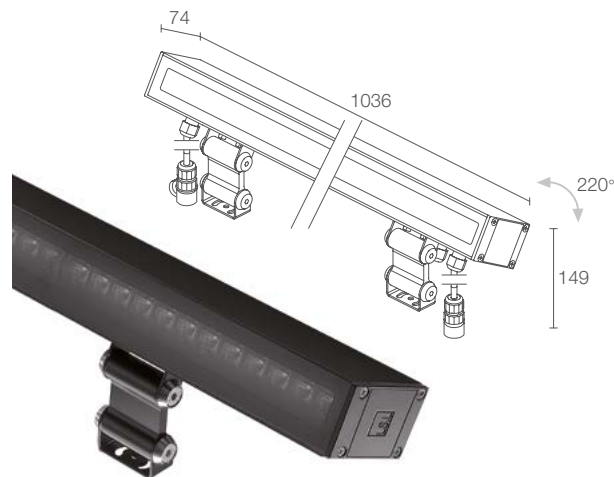
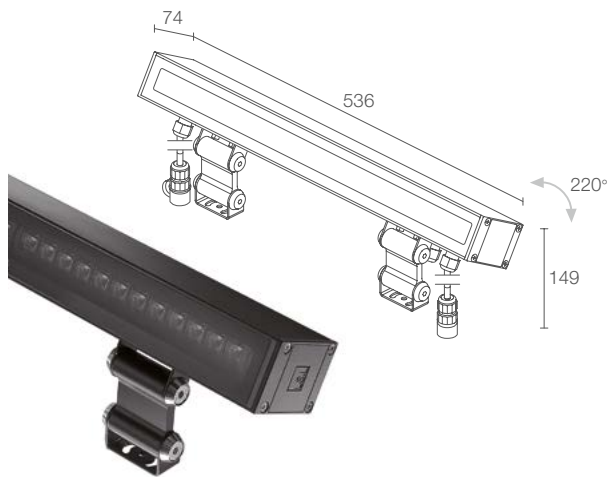

TAGO 3.1 On/off version: 1 cable gland
DALI, 0/1-10V version: 3 cable glands, 2 connectors

TAGO 3.3 On/off version: 1 cable gland
DALI, 0/1-10V version: 3 cable glands, 2 connectors

CE ENEC LED TECH kg 1.884 IP65 IP67 IK09
A A+ A++ IPS PID DALI 0/1-10V

CE ENEC LED TECH kg 3.60 IP65 IP67 IK09
A A+ A++ IPS PID DALI 0/1-10V

24W 230Vac 536 mm pitch 20
TG31100 ■ 0 ■ 1 ■ 2 ■ N Black

51W 230Vac 1036 mm pitch 20
TG33100 ■ 0 ■ 1 ■ 2 ■ N Black

■	0 - on/off 2 - 0/1-10V D - DALI
■	0 - none 1 - honeycomb louvre (not compatible with 11°, 17°, wall grazing and wall washer optics) 2 - anti-glare shield (not compatible with 11°, wall grazing and wall washer optics)
■	N - 2200K F - 2700K 5 - 3000K 9 - 4000K
■	S - 11° M - 17° L - 29° K - 69° W - 20°x49° G - wall grazing A - wall washer

■	0 - on/off 2 - 0/1-10V D - DALI
■	0 - none 1 - honeycomb louvre (not compatible with 11°, 17°, wall grazing and wall washer optics) 2 - anti-glare shield (not compatible with 11°, wall grazing and wall washer optics)
■	N - 2200K F - 2700K 5 - 3000K 9 - 4000K
■	S - 11° M - 17° L - 29° K - 69° W - 20°x49° G - wall grazing A - wall washer

2984 lm (3000K)

5968 lm (3000K)

1864 lm (3000K, 29°)

3728 lm (3000K, 29°)

24 SMD LEDs, pitch 20 mm, 2-step MacAdam, 60000h L80 B10 (Ta 25°C)
2200K: 3-step MacAdam, 60000h L80 B10 (Ta 25°C)

48 SMD LEDs, pitch 20 mm, 2-step MacAdam, 60000h L80 B10 (Ta 25°C)
2200K: 3-step MacAdam, 60000h L80 B10 (Ta 25°C)

body in anticorrosional aluminium; bracket in stainless steel
screen in grey-serigraphed and transparent, tempered extra-clear glass; screen in grey-serigraphed, acid-etched, tempered extra-clear glass (wall-washer optics)
caps in die-cast aluminium

body in anticorrosional aluminium; bracket in stainless steel
screen in grey-serigraphed and transparent, tempered extra-clear glass; screen in grey-serigraphed, acid-etched, tempered extra-clear glass (wall-washer optics)
caps in die-cast aluminium

built in

built in

on/off: includes 1.5 m neoprene cable HO7RN-F 3x1.0 Ø9.3 mm; DALI, 0/1-10V: includes 1x1.5 m neoprene cable HO7RN-F 3x1.0 Ø9.3 mm and 2x0.75 m neoprene cables HO5RN-F 2x1.0 Ø6.7 mm

on/off: includes 1.5 m neoprene cable HO7RN-F 3x1.0 Ø9.3 mm; DALI, 0/1-10V: includes 1x1.5 m neoprene cable HO7RN-F 3x1.0 Ø9.3 mm and 2x0.75 m neoprene cables HO5RN-F 2x1.0 Ø6.7 mm

surface mounted (ceiling, wall, ground)

surface mounted (ceiling, wall, ground)

see p. 182 and 183

see p. 182 and 183

central bracket with two pivot points for accurate adjustment; anti-glare accessories, honeycomb louvre and anti-glare shield, built into the lighting fixture

central bracket with two pivot points for accurate adjustment; anti-glare accessories, honeycomb louvre and anti-glare shield, built into the lighting fixture

Casambi-compatible version, controllable with the Casambi app, available on request

Casambi-compatible version, controllable with the Casambi app, available on request

see p. 891

see p. 891



Black



Rebated installation

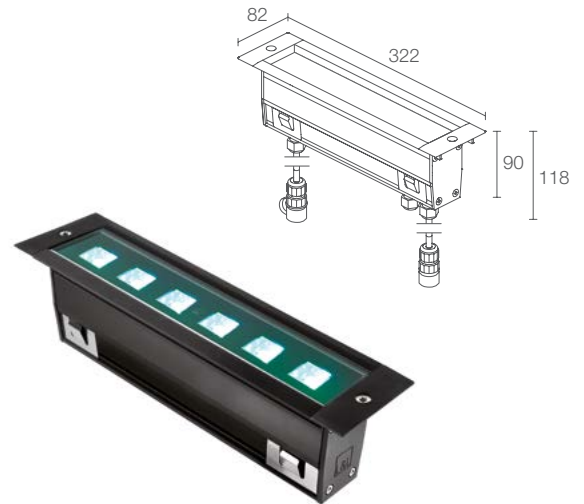

TAGO 4.0

3 cable glands, 2 connectors



POWER / POWER SUPPLY CODE

14W 48Vdc 322 mm pitch 41.7
TG4030040070 ■ N Anodized black

OPTICS

S - 24°
M - 30°
L - 52°

LED COLOUR

RGBW

LUMEN OUTPUT AT SOURCE

R: 144 lm G: 948 lm B: 228 lm W: 750 lm (4000K)

DELIVERED LUMEN OUTPUT

1374 lm
 R: 90 lm G: 660 lm B: 132 lm W: 492 lm (4000K, 24°)

NO. AND TYPE OF LED

24 high-powerLEDs, 60000h L80 B10 (Ta 25°C)

MATERIAL

body in black-anodized anticorrosion aluminium
 screen in grey-serigraphed and transparent, tempered extra-clear glass
 caps in technopolymer

POWER SUPPLY UNIT

not included, see p. 904 and 917

POWER CABLES

includes 1.5 m neoprene cable H07RN-F 2x1.0 Ø8.7 mm and 2 cables for DMX signal with shielded cable of 0.75 m Ø5.5 mm

MOUNTING

recessed (ground)

ACCESSORIES

see p. 182 and 183

FEATURES

easy wiring with quick connectors designed to connect the profiles one after the other

PHOTOMETRIC DATA

see p. 892

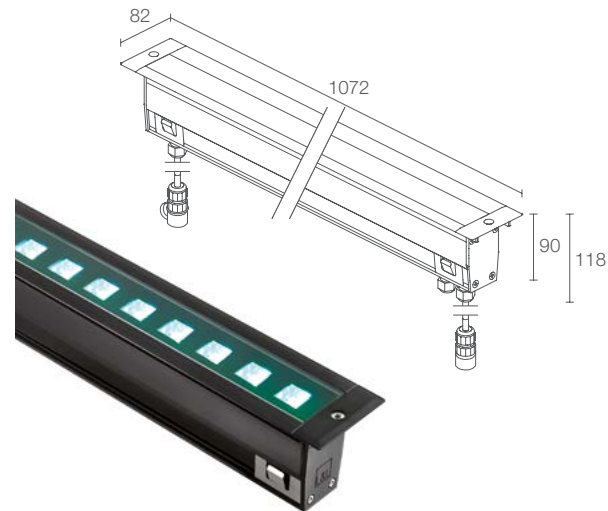
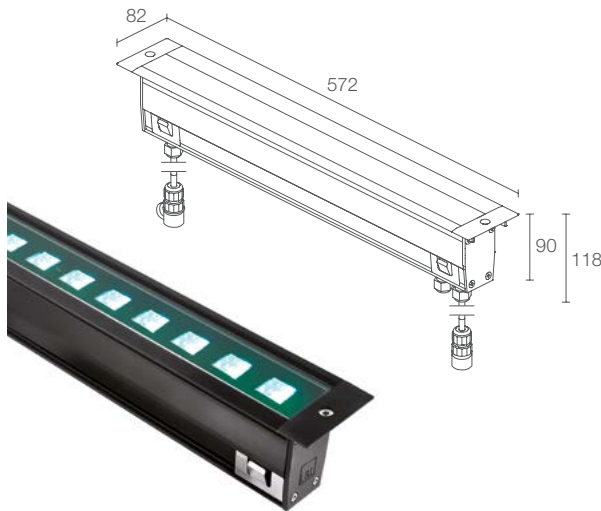

TAGO 4.1

3 cable glands, 2 connectors

IP65 IP67 IK09 DMX512 RDM

A A+ A++ T max 40°C

24W 48Vdc 572 mm pitch 41.7

TG4130040070 ■ N Anodized black

29W 230Vac 572 mm pitch 41.7

TG4110040070 ■ N Anodized black

S - 24°
 M - 30°
 L - 52°

RGBW

R: 288 lm G: 1896 lm B: 456 lm W: 1500 lm (4000K)

2748 lm
 R: 180 lm G: 1320 lm B: 264 lm W: 984 lm (4000K, 24°)

48 high-power LEDs, 60000h L80 B10 (Ta 25°C)

body in black-anodized anticorrosional aluminium
 screen in grey-serigraphed and transparent, tempered extra-clear glass
 caps in technopolymer

230Vac: built in
 48Vdc: not included, see p. 904 and 917

230Vac: includes 1.5 m neoprene cable H07RN-F 3x1.0 Ø9.3 mm and 2 cables for DMX signal with shielded cable of 0.75 m Ø5.5 mm
 48Vdc: includes 1.5 m neoprene cable H07RN-F 2x1.0 Ø8.7 mm and 2 cables for DMX signal with shielded cable of 0.75 m Ø5.5 mm

recessed (ground)

see p. 182 and 183

easy wiring with quick connectors designed to connect the profiles one after the other

see p. 892

TAGO 4.3

3 cable glands, 2 connectors

IP65 IP67 IK09 DMX512 RDM

A A+ A++ T max 40°C

49W 48Vdc 1072 mm pitch 41.7

TG4330040070 ■ N Anodized black

55W 230Vac 1072 mm pitch 41.7

TG4310040070 ■ N Anodized black

S - 24°
 M - 30°
 L - 52°

RGBW

R: 576 lm G: 3792 lm B: 912 lm W: 3000 lm (4000K)

5496 lm
 R: 360 lm G: 2640 lm B: 528 lm W: 1968 lm (4000K, 24°)

96 high-power LEDs, 60000h L80 B10 (Ta 25°C)

body in black-anodized anticorrosional aluminium
 screen in grey-serigraphed and transparent, tempered extra-clear glass
 caps in technopolymer

230Vac: built in
 48Vdc: not included, see p. 904 and 917

230Vac: includes 1.5 m neoprene cable H07RN-F 3x1.0 Ø9.3 mm and 2 cables for DMX signal with shielded cable of 0.75 m Ø5.5 mm
 48Vdc: includes 1.5 m neoprene cable H07RN-F 2x1.0 Ø8.7 mm and 2 cables for DMX signal with shielded cable of 0.75 m Ø5.5 mm

recessed (ground)

see p. 182 and 183

easy wiring with quick connectors designed to connect the profiles one after the other

see p. 892

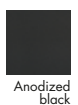

Anodized black



Installation flush
with ground

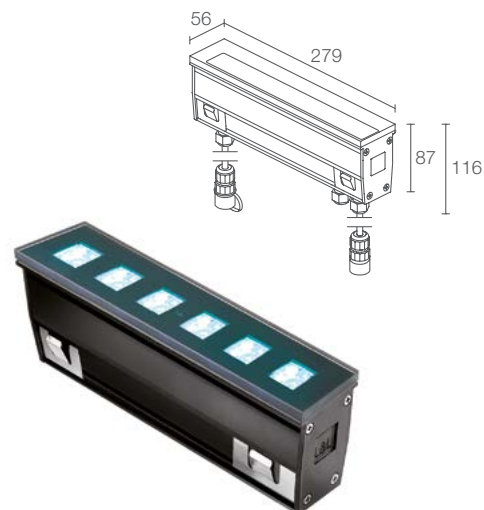

TAGO 5.0

3 cable glands, 2 connectors



POWER / POWER SUPPLY CODE

14W 48Vdc 279 mm pitch 41.7
TG5030040070 ■ V

OPTICS

S - 24°
M - 30°
L - 52°

LED COLOUR

RGBW

LUMEN OUTPUT AT SOURCE R: 144 lm G: 948 lm B: 228 lm W: 750 lm (4000K)

DELIVERED LUMEN OUTPUT R: 90 lm G: 660 lm B: 132 lm W: 492 lm (4000K, 24°)

NO. AND TYPE OF LED 24 high-power LEDs, 60000h L80 B10 (Ta 25°C)

MATERIAL body in black-anodized anticorrosion aluminium screen in grey-serigraphed and transparent, tempered extra-clear glass caps in technopolymer

POWER SUPPLY UNIT not included, see p. 904 and 917

POWER CABLES includes 1.5 m neoprene cable H07RN-F 2x1.0 Ø8.7 mm and 2 cables for DMX signal with shielded cable of 0.75 m Ø5.5 mm

MOUNTING recessed (ground)

ACCESSORIES see p. 182 and 183

FEATURES easy wiring with quick connectors designed to connect the profiles one after the other

PHOTOMETRIC DATA see p. 892

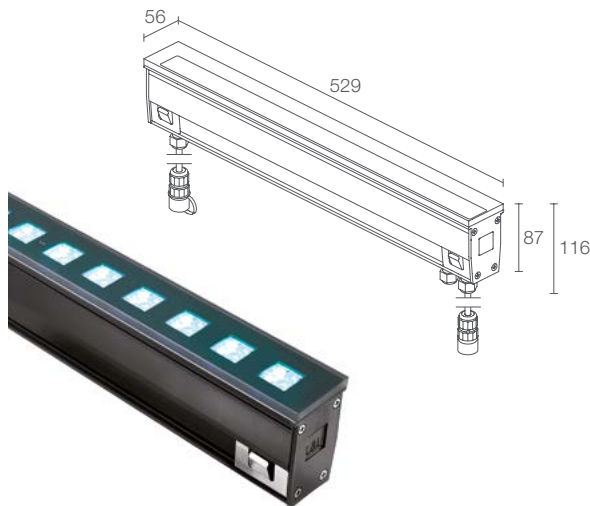

TAGO 5.1

3 cable glands, 2 connectors



24W 48Vdc 529 mm pitch 41.7

TG5130040070 ■ V

29W 230Vac 529 mm pitch 41.7

TG5110040070 ■ V

S - 24°
M - 30°
L - 52°

RGBW

R: 288 lm G: 1896 lm B: 456 lm W: 1500 lm (4000K)

2748 lm
R: 180 lm G: 1320 lm B: 264 lm W: 984 lm (4000K, 24°)

48 high-power LEDs,
60000h L80 B10 (Ta 25°C)

body in black-anodized anticorrosional aluminium
screen in grey-serigraphed and transparent, tempered
extra-clear glass
caps in technopolymer

230Vac: built in
48Vdc: not included, see p. 904 and 917

230Vac: includes 1.5 m neoprene cable
H07RN-F 3x1.0 Ø9.3 mm and 2 cables for DMX signal
with shielded cable of 0.75 m Ø5.5 mm
48Vdc: includes 1.5 m neoprene cable
H07RN-F 2x1.0 Ø8.7 mm and 2 cables for DMX signal
with shielded cable of 0.75 m Ø5.5 mm

recessed (ground)

see p. 182 and 183

easy wiring with quick connectors designed to connect
the profiles one after the other

see p. 892

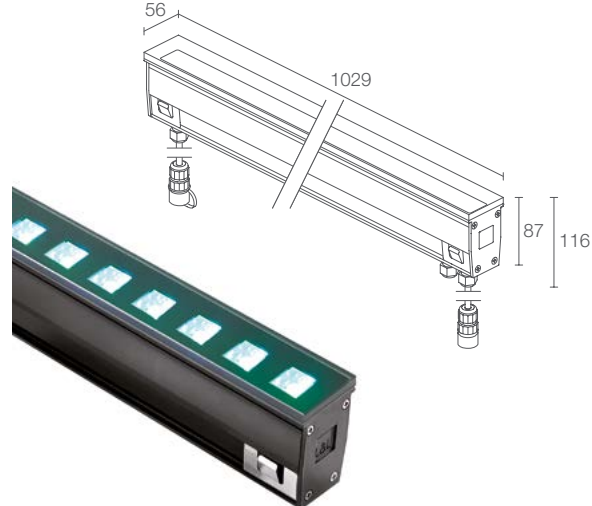

TAGO 5.3

3 cable glands, 2 connectors



49W 48Vdc 1029 mm pitch 41.7

TG5330040070 ■ V

55W 230Vac 1029 mm pitch 41.7

TG5310040070 ■ V

S - 24°
M - 30°
L - 52°

RGBW

R: 576 lm G: 3792 lm B: 912 lm W: 3000 lm (4000K)

5496 lm
R: 360 lm G: 2640 lm B: 528 lm W: 1968 lm (4000K, 24°)

96 high-power LEDs,
60000h L80 B10 (Ta 25°C)

body in black-anodized anticorrosional aluminium
screen in grey-serigraphed and transparent, tempered
extra-clear glass
caps in technopolymer

230Vac: built in
48Vdc: not included, see p. 904 and 917

230Vac: includes 1.5 m neoprene cable
H07RN-F 3x1.0 Ø9.3 mm and 2 cables for DMX signal
with shielded cable of 0.75 m Ø5.5 mm
48Vdc: includes 1.5 m neoprene cable
H07RN-F 2x1.0 Ø8.7 mm and 2 cables for DMX signal
with shielded cable of 0.75 m Ø5.5 mm

recessed (ground)

see p. 182 and 183

easy wiring with quick connectors designed to connect
the profiles one after the other

see p. 892

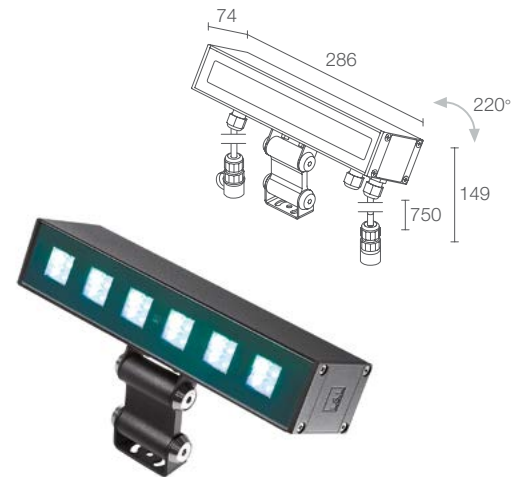

TAGO 6.0

3 cable glands, 2 connectors



POWER / POWER SUPPLY CODE 14W 48Vdc 286 mm pitch 41.7
TG6030040070 ■ N Black

OPTICS S - 24°
M - 30°
L - 52°

LED COLOUR RGBW

LUMEN OUTPUT AT SOURCE R: 144 lm G: 948 lm B: 228 lm W: 750 lm (4000K)

DELIVERED LUMEN OUTPUT 1374 lm
R: 90 lm G: 660 lm B: 132 lm W: 492 lm (4000K, 24°)

NO. AND TYPE OF LED 24 high-power LEDs, 60000h L80 B10 (Ta 25°C)

MATERIAL body in anticorrosional aluminium
bracket in stainless steel
screen in grey-serigraphed and transparent, tempered extra-clear glass
caps made of die-cast aluminium

POWER SUPPLY UNIT not included, see p. 904 and 917

POWER CABLES includes 1.5 m neoprene cable H07RN-F 2x1.0 Ø8.7 mm and 2 cables for DMX signal with shielded cable of 0.75 m Ø5.5 mm

MOUNTING surface mounted (ceiling, wall, ground)

ACCESSORIES see p. 182 and 183

FEATURES easy wiring with quick connectors designed to connect the profiles one after the other
two brackets with two pivot points for accurate adjustment

PHOTOMETRIC DATA see p. 892

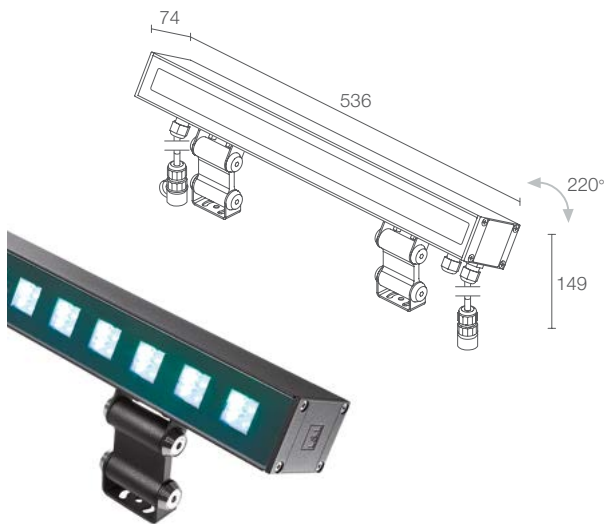

TAGO 6.1

3 cable glands, 2 connectors

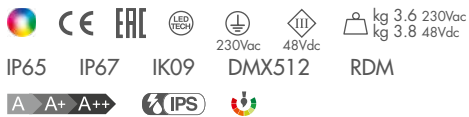

24W 48Vdc 536 mm pitch 41.7
TG6130040070 ■ N Black

29W 230Vac 536 mm pitch 41.7
TG6110040070 ■ N Black

■ S - 24°
 M - 30°
 L - 52°

RGBW

R: 288 lm G: 1896 lm B: 456 lm W: 1500 lm (4000K)

2748 lm
 R: 180 lm G: 1320 lm B: 264 lm W: 984 lm (4000K, 24°)

48 high-power LEDs,
 60000h L80 B10 (Ta 25°C)

body in anticorrosion aluminium
 bracket in stainless steel
 screen in grey-serigraphed and transparent, tempered
 extra-clear glass
 caps made of die-cast aluminium

230Vac: built in
 48Vdc: not included, see p. 904 and 917

230Vac: includes 1.5 m neoprene cable
 H07RN-F 3x1.0 Ø9.3 mm and 2 cables for DMX signal
 with shielded cable of 0.75 m Ø5.5 mm
 48Vdc: includes 1.5 m neoprene cable
 H07RN-F 2x1.0 Ø8.7 mm and 2 cables for DMX signal
 with shielded cable of 0.75 m Ø5.5 mm

surface mounted (ceiling, wall, ground)

see p. 182 and 183

easy wiring with quick connectors designed to connect
 the profiles one after the other
 two brackets with two pivot points for accurate adjustment

see p. 892

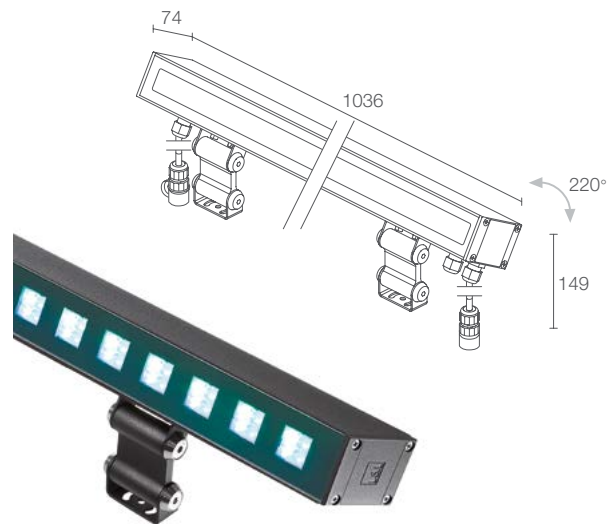

TAGO 6.3

3 cable glands, 2 connectors



49W 48Vdc 1036 mm pitch 41.7
TG6330040070 ■ N Black

55W 230Vac 1036 mm pitch 41.7
TG6310040070 ■ N Black

■ S - 24°
 M - 30°
 L - 52°

RGBW

R: 576 lm G: 3792 lm B: 912 lm W: 3000 lm (4000K)

5496 lm
 R: 360 lm G: 2640 lm B: 528 lm W: 1968 lm (4000K, 24°)

96 high-power LEDs,
 60000h L80 B10 (Ta 25°C)

body in anticorrosion aluminium
 bracket in stainless steel
 screen in grey-serigraphed and transparent, tempered
 extra-clear glass
 caps made of die-cast aluminium

230Vac: built in
 48Vdc: not included, see p. 904 and 917

230Vac: includes 1.5 m neoprene cable
 H07RN-F 3x1.0 Ø9.3 mm and 2 cables for DMX signal
 with shielded cable of 0.75 m Ø5.5 mm
 48Vdc: includes 1.5 m neoprene cable
 H07RN-F 2x1.0 Ø8.7 mm and 2 cables for DMX signal
 with shielded cable of 0.75 m Ø5.5 mm

surface mounted (ceiling, wall, ground)

see p. 182 and 183

easy wiring with quick connectors designed to connect
 the profiles one after the other
 two brackets with two pivot points for accurate adjustment

see p. 892



Black

**ACCESSORIES
FOR INSTALLATION**



Outer casing



Outer casing

TAGO 1.0	WCTG10A0T - 313 mm
TAGO 1.1	WCTG11A0T - 563 mm
TAGO 1.3	WCTG13A0T - 1063 mm
TAGO 2.0	WCTG20A0F - 283 mm
TAGO 2.1	WCTG21A0F - 533 mm
TAGO 2.3	WCTG23A0F - 1033 mm
TAGO 4.0	WCTG10A0T - 313 mm
TAGO 4.1	WCTG11A0T - 563 mm
TAGO 4.3	WCTG13A0T - 1063 mm
TAGO 5.0	WCTG20A0F - 283 mm
TAGO 5.1	WCTG21A0F - 533 mm
TAGO 5.3	WCTG23A0F - 1033 mm

∨
TAGO 3.3
 3000K, 51W, 69°, black

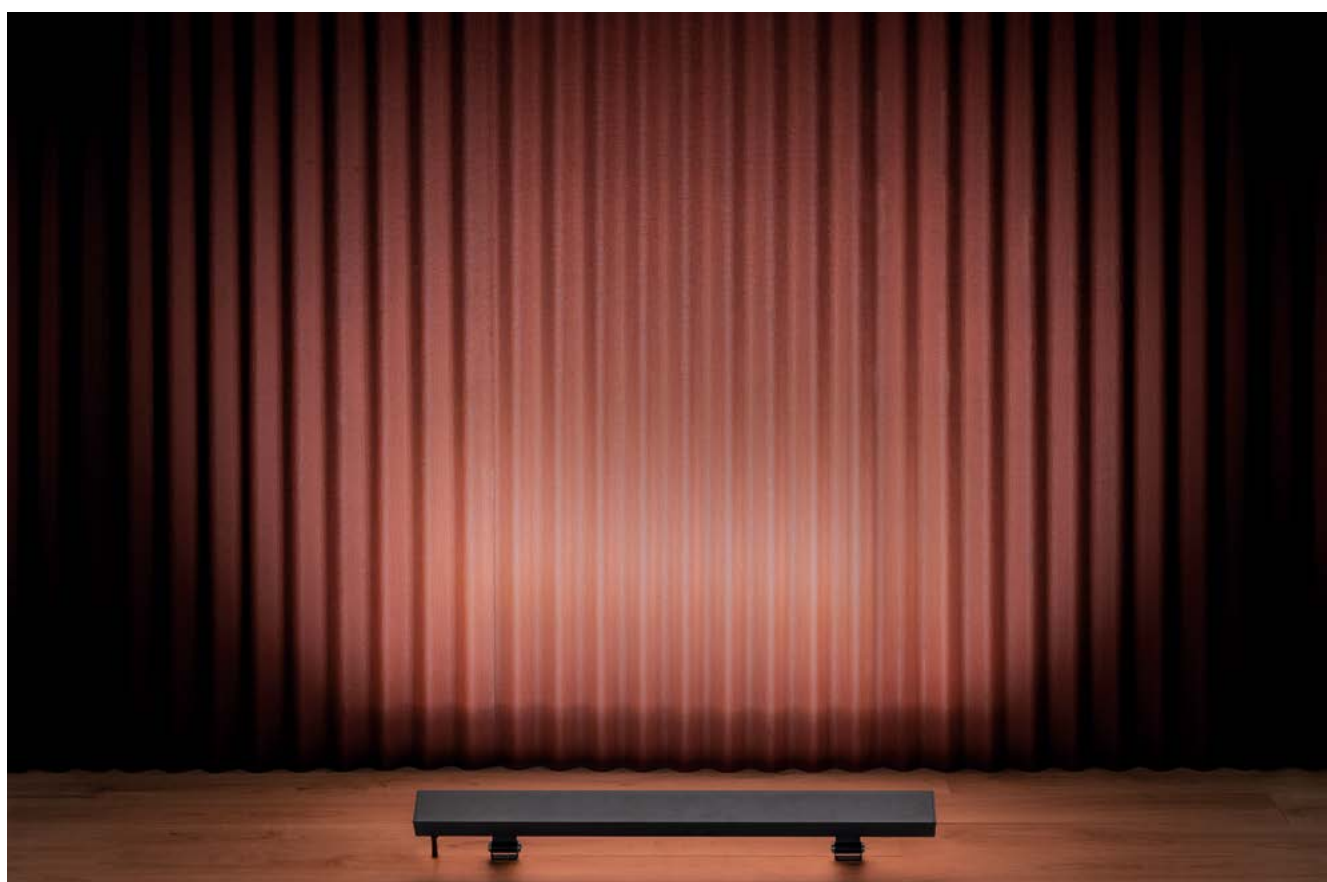

ACCESSORIES

ACCESSORIES FOR INSTALLATION

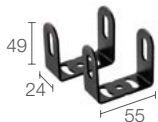

WMA03N

Pair of adjustable brackets
(Tago 3 / 6)



WN6005

Alignment kit for outer casings
(Tago 2 / 5)



WFA0005

5-m 4-pin interconnect cable
(DALI or 0/1-10V version)
(Tago 1 / 2 / 3)



WFA03

3-pin female connector
for in/out connection - IP66-IP68



WFA04

3-pin male connector
for in/out connection - IP66-IP68



WFA0105

5-m 3-pin interconnect cable
for DMX signal
(Tago 4 / 5 / 6)

for spare parts, see p. 932 and 934



^
NEVA 1.0
 3000K, 18W, 10°x40°
NEVA MINI 1
 3000K, 9W, 11°

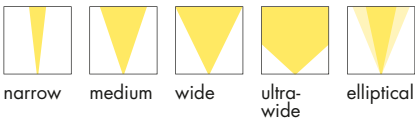

PITCH 60 mm



PITCH 120 mm



PITCH 60 mm
 BUILT-IN POWER SUPPLY UNIT

316 mm



NEVA MINI 1 p. 188
 9W/13W 24Vdc



NEVA MINI 2 p. 190
 5.5W/7.5W 24Vdc

616 mm
 677 mm



NEVA 1.0 p. 188
 18W/25W 24Vdc



NEVA 2.0 p. 190
 11W/15W 24Vdc



NEVA 3.0 p. 194
 23W 230Vac
 ON/OFF, 0/1-10V

916 mm
 1037 mm



NEVA 1.1 p. 189
 27W/38W 24Vdc



NEVA 2.1 p. 191
 16W/22W 24Vdc



NEVA 3.1 p. 195
 39W 230Vac
 ON/OFF, 0/1-10V

1517 mm
 1758 mm



NEVA 1.2 p. 189
 45W/63W 24Vdc



NEVA 2.2 p. 191
 27W/38W 24Vdc



NEVA 3.2 p. 195
 64W 230Vac
 ON/OFF

OUTDOOR LINEAR PROFILES ARCHITECTURAL LIGHTING FOR WALLS AND FACADES



PITCH 120 mm
BUILT-IN POWER SUPPLY UNIT



PITCH 120 mm



DYNAMIC WHITE

PITCH 120 mm



RGBW

PITCH 120 mm



NEVA MINI 5 p. 198
10W 24Vdc



NEVA MINI 6 p. 200
10W 24Vdc

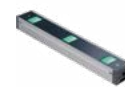

NEVA MINI 7 p. 202
15W 24Vdc



NEVA 4.0 p. 196
16W 230Vac
ON/OFF, 0/1-10V



NEVA 5.0 p. 198
20W 24Vdc
with or without DMX



NEVA 6.0 p. 200
20W 24Vdc



NEVA 7.0 p. 202
30W 24Vdc



NEVA 4.1 p. 197
24W 230Vac
ON/OFF, 0/1-10V



NEVA 5.1 p. 199
30W 24Vdc



NEVA 6.1 p. 201
30W 24Vdc

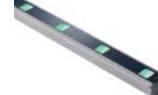

NEVA 7.1 p. 203
45W 24Vdc



NEVA 4.2 p. 197
40W 230Vac
ON/OFF, 0/1-10V



NEVA 5.2 p. 199
50W 24Vdc



NEVA 6.2 p. 201
50W 24Vdc

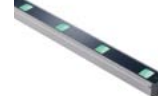

NEVA 7.2 p. 203
75W 24Vdc

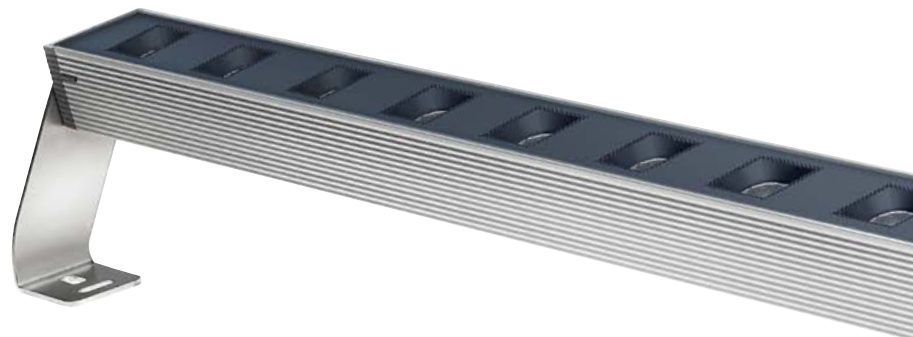
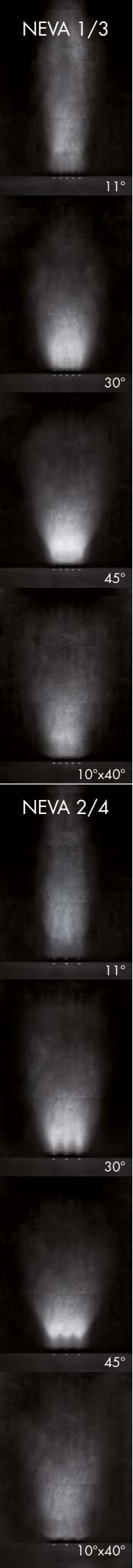

IP65 / IP67
SUITABLE FOR OUTDOOR APPLICATIONS



BUILT-IN PROTECTION SYSTEMS:
IPS
INTELLIGENT PROTECTION SYSTEM



PID
PROTECTIVE IMPEDANCE DEVICE



NTC
BUILT-IN TEMPERATURE SENSOR



IK06 (NEVA 1 / 2 / 5 / 6 / 7)



IK08 (NEVA 3 / 4)

HIGH-TRANSMITTANCE, TRANSPARENT, TEMPERED
EXTRA-CLEAR GLASS SCREEN WITH VITRIFIED SERIGRAPHY
TO ENSURE CHROMATIC UNIFORMITY OF LIGHT. THE GLASS'S
THICKNESS OF 4 MM GUARANTEES HIGH IMPACT RESISTANCE

BODY IN LOW-COPPER-CONTENT
ANTICORODAL ALUMINIUM ALLOY 6060
FOR EXCELLENT CORROSION RESISTANCE
AND IMPROVED HEAT DISSIPATION.
THE ANODIZATION PROCESS PROTECTS
THE FIXTURE'S FUNCTIONING AND
APPEARANCE FROM ATMOSPHERIC
AND ENVIRONMENTAL CONDITIONS

UNIQUE SELLING POINTS



ANTI-GLARE
RECESSED OPTICS



NEVA 1 / 3
PITCH CONSISTENCY
BETWEEN DEVICES
PLACED SIDE BY SIDE



NEVA 3 / 4
IP68 CONNECTOR WITH
BUILT-IN IPS PROTECTION
Speedy installation: electrical wiring simplified by the ability to connect the electrical cables directly to the connector. An in/out connection system is available to install the fixtures in a line.



RECESSED
INSTALLATION
USING DEDICATED
OUTER CASING



SCALED ADJUSTABLE
BRACKET AND TWO
DIFFERENT HEIGHTS:
75 MM, 140 MM



ANTI-GLARE
HONEYCOMB
LOUVRE ACCESSORY



< **NEVA 1.1**
2700K, 27W, 10°x40°, with honeycomb louvre
customized version with CRI >90

BRIGHT 1.6
2700K, 2W, 10°

Light planning by / Susanna Antico
Lighting Design Studio
Cascina Ranverso
Buttiglieria Alta, Turin, Italy

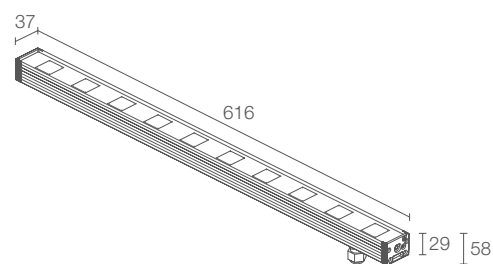
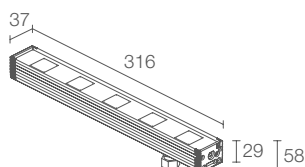

NEVA MINI 1



POWER / POWER SUPPLY CODE	9W 24Vdc 316 mm pitch 60 NV0100 ■ ■ ■ A - ■ ■ 13W 24Vdc 316 mm pitch 60 NV0101 ■ ■ ■ A - ■ ■
LED COLOUR	F - 2700K 5 - 3000K 9 - 4000K
OPTICS	S - 11° M - 30° L - 45° W - 10°x40°
POWER CABLES	includes 1.5 m neoprene cable H05RN-F 2x0.75 Ø6.3 mm 1 - 5 m 2 - 10 m 3 - 15 m 4 - 20 m

LUMEN OUTPUT AT SOURCE	696 lm (3000K, 9W) 1033 lm (3000K, 13W)
DELIVERED LUMEN OUTPUT	575 lm (3000K, 30°, 9W) 805 lm (3000K, 30°, 13W)
NO. AND TYPE OF LED	5 power LEDs, pitch 60 mm 3-step MacAdam, 50000h L90 B10 (Ta 25°C)
MATERIAL	body in anodized anticorrosion aluminium screen in serigraphed and transparent, tempered extra-clear glass
POWER SUPPLY UNIT	not included, see p. 904
MOUNTING	surface mounted (ceiling, wall, ground) with brackets recessed (ceiling, wall, ground) with outer casing
ACCESSORIES	see p. 204 and 205
PHOTOMETRIC DATA	see p. 853

NEVA 1.0



POWER / POWER SUPPLY CODE	18W 24Vdc 616 mm pitch 60 NV1000 ■ ■ ■ A - ■ ■ 25W 24Vdc 616 mm pitch 60 NV1001 ■ ■ ■ A - ■ ■
LED COLOUR	F - 2700K 5 - 3000K 9 - 4000K
OPTICS	S - 11° M - 30° L - 45° W - 10°x40°
POWER CABLES	includes 1.5 m neoprene cable H05RN-F 2x0.75 Ø6.3 mm 1 - 5 m 2 - 10 m 3 - 15 m 4 - 20 m

LUMEN OUTPUT AT SOURCE	1392 lm (3000K, 18W) 2065 lm (3000K, 25W)
DELIVERED LUMEN OUTPUT	1150 lm (3000K, 30°, 18W) 1610 lm (3000K, 30°, 25W)
NO. AND TYPE OF LED	10 power LEDs, pitch 60 mm 3-step MacAdam, 50000h L90 B10 (Ta 25°C)
MATERIAL	body in anodized anticorrosion aluminium screen in serigraphed and transparent, tempered extra-clear glass
POWER SUPPLY UNIT	not included, see p. 904
MOUNTING	surface mounted (ceiling, wall, ground) with brackets recessed (ceiling, wall, ground) with outer casing
ACCESSORIES	see p. 204 and 205
PHOTOMETRIC DATA	see p. 855

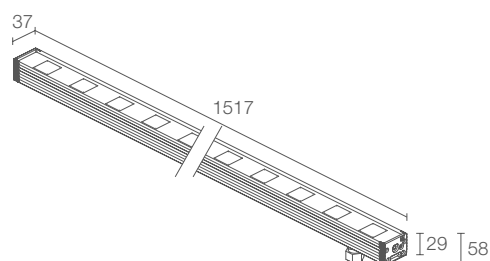
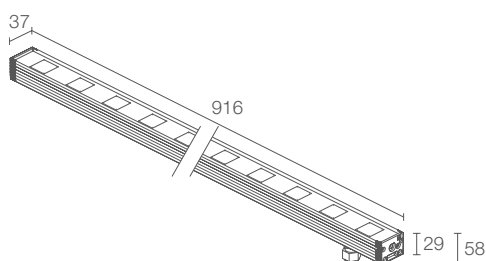

NEVA 1.1



kg 1.64 IP65 IP67 IK06

A A+ A++ **IP** **PID** NTC CASAMBI (T max 45°C)

27W 24Vdc 916 mm pitch 60

NV1100 ■ ■ ■ A - ■

38W 24Vdc 916 mm pitch 60

NV1101 ■ ■ ■ A - ■

■	F - 2700K 5 - 3000K 9 - 4000K
■	S - 11° M - 30° L - 45° W - 10°x40°
■	includes 1.5 m neoprene cable H05RN-F 2x0.75 Ø6.3 mm 1 - 5 m 2 - 10 m 3 - 15 m 4 - 20 m

2087 lm (3000K, 27W)
3098 lm (3000K, 38W)

1715 lm (3000K, 30°, 27W)
2401 lm (3000K, 30°, 38W)

15 power LEDs, pitch 60 mm
3-step MacAdam, 50000h L90 B10 (Ta 25°C)

body in anodized anticorrosion aluminium
screen in serigraphed and transparent, tempered
extra-clear glass

not included, see p. 904

surface mounted (ceiling, wall, ground) with brackets
recessed (ceiling, wall, ground) with outer casing

see p. 204 and 205

see p. 855

NEVA 1.2



kg 2.75 IP65 IP67 IK06

A A+ A++ **IP** **PID** NTC CASAMBI (T max 45°C)

45W 24Vdc 1517 mm pitch 60

NV1200 ■ ■ ■ A - ■

63W 24Vdc 1517 mm pitch 60

NV1201 ■ ■ ■ A - ■

■	F - 2700K 5 - 3000K 9 - 4000K
■	S - 11° M - 30° L - 45° W - 10°x40°
■	includes 1.5 m neoprene cable H05RN-F 2x0.75 Ø6.3 mm 1 - 5 m 2 - 10 m 3 - 15 m 4 - 20 m

3479 lm (3000K, 45W)
5163 lm (3000K, 63W)

2875 lm (3000K, 30°, 45W)
4025 lm (3000K, 30°, 63W)

25 power LEDs, pitch 60 mm
3-step MacAdam, 50000h L90 B10 (Ta 25°C)

body in anodized anticorrosion aluminium
screen in serigraphed and transparent, tempered
extra-clear glass

not included, see p. 904

surface mounted (ceiling, wall, ground) with brackets
recessed (ceiling, wall, ground) with outer casing

see p. 204 and 205

see p. 855



< **NEVA 2.0**
3000K, 11W, 45°, with brackets
BRIGHT 2.4
3000K, 7W, 11° - 45°, stainless steel

Project by / arch. Fernanda Cantone
Light planning by / Light Style
Castello Tafuri Charming Suites
Portopalo di Capo Passero, Syracuse, Italy

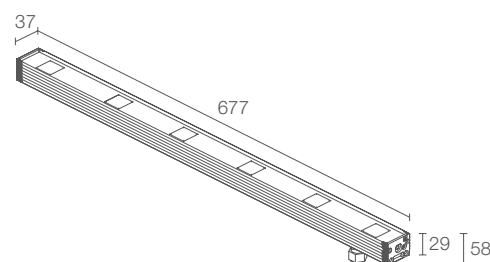
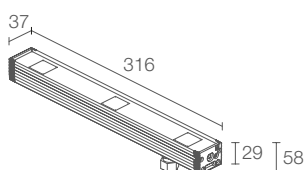

NEVA MINI 2

CE CB ENEC 8 LED TECH III
kg 0.58 IP65 IP67 IK06
A+ A++ IPS PID NTC CASAMBI T max 45°C

POWER / POWER SUPPLY CODE
5.5W 24Vdc 316 mm pitch 120
NV0200 ■ ■ ■ A - ■ ■
7.5W 24Vdc 316 mm pitch 120
NV0201 ■ ■ ■ A - ■ ■

LED COLOUR	F - 2700K 5 - 3000K 9 - 4000K
OPTICS	S - 11° M - 30° L - 45° W - 10°x40°
POWER CABLES	includes 1.5 m neoprene cable H05RN-F 2x0.75 Ø6.3 mm 1 - 5 m 2 - 10 m 3 - 15 m 4 - 20 m

LUMEN OUTPUT AT SOURCE	418 lm (3000K, 5.5W) 620 lm (3000K, 7.5W)
DELIVERED LUMEN OUTPUT	345 lm (3000K, 30°, 5.5W) 483 lm (3000K, 30°, 7.5W)
NO. AND TYPE OF LED	3 power LEDs, pitch 120 mm 3-step MacAdam 50000h L90 B10 (Ta 25°C)
MATERIAL	body in anodized anticorrosional aluminium screen in serigraphed and transparent, tempered extra-clear glass
POWER SUPPLY UNIT	not included, see p. 904
MOUNTING	surface mounted (ceiling, wall, ground) with brackets recessed (ceiling, wall, ground) with outer casing
ACCESSORIES	see p. 204 and 205
PHOTOMETRIC DATA	see p. 853

NEVA 2.0

CE CB ENEC 8 LED TECH III
kg 1.25 IP65 IP67 IK06
A+ A++ IPS PID NTC CASAMBI T max 45°C

11W 24Vdc 677 mm pitch 120
NV2000 ■ ■ ■ A - ■ ■
15W 24Vdc 677 mm pitch 120
NV2001 ■ ■ ■ A - ■ ■

LED COLOUR	F - 2700K 5 - 3000K 9 - 4000K
OPTICS	S - 11° M - 30° L - 45° W - 10°x40°
POWER CABLES	includes 1.5 m neoprene cable H05RN-F 2x0.75 Ø6.3 mm 1 - 5 m 2 - 10 m 3 - 15 m 4 - 20 m

LUMEN OUTPUT AT SOURCE	835 lm (3000K, 11W) 1239 lm (3000K, 15W)
DELIVERED LUMEN OUTPUT	690 lm (3000K, 30°, 11W) 966 lm (3000K, 30°, 15W)
NO. AND TYPE OF LED	6 power LEDs, pitch 120 mm 3-step MacAdam 50000h L90 B10 (Ta 25°C)
MATERIAL	body in anodized anticorrosional aluminium screen in serigraphed and transparent, tempered extra-clear glass
POWER SUPPLY UNIT	not included, see p. 904
MOUNTING	surface mounted (ceiling, wall, ground) with brackets recessed (ceiling, wall, ground) with outer casing
ACCESSORIES	see p. 204 and 205
PHOTOMETRIC DATA	see p. 855

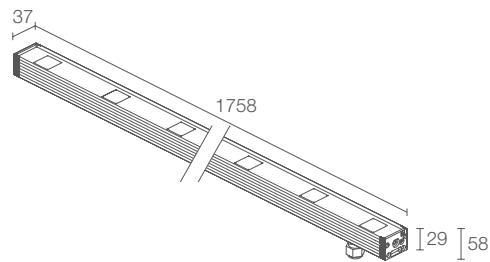
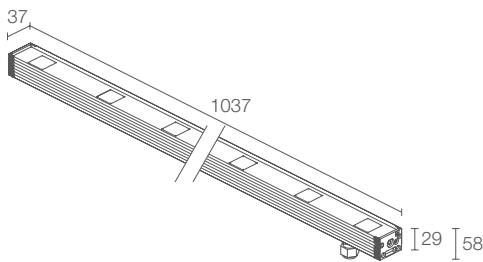

NEVA 2.1



kg 1.87 IP65 IP67 IK06

A A+ A++ **IP** **PID** NTC CASAMBI T max 45°C

16W 24Vdc 1037 mm pitch 120

NV2100 ■ ■ ■ A - ■

22W 24Vdc 1037 mm pitch 120

NV2101 ■ ■ ■ A - ■

■	F - 2700K 5 - 3000K 9 - 4000K
■	S - 11° M - 30° L - 45° W - 10°x40°
■	includes 1.5 m neoprene cable H05RN-F 2x0.75 Ø6.3 mm 1 - 5 m 2 - 10 m 3 - 15 m 4 - 20 m

1252 lm (3000K, 16W)
1859 lm (3000K, 22W)

1035 lm (3000K, 30°, 16W)
1450 lm (3000K, 30°, 22W)

9 power LEDs, pitch 120 mm
3-step MacAdam
50000h L90 B10 (Ta 25°C)

body in anodized anticorrosion aluminium
screen in serigraphed and transparent, tempered
extra-clear glass

not included, see p. 904

surface mounted (ceiling, wall, ground) with brackets
recessed (ceiling, wall, ground) with outer casing

see p. 204 and 205

see p. 855

NEVA 2.2



kg 3.15 IP65 IP67 IK06

A A+ A++ **IP** **PID** NTC CASAMBI T max 45°C

27W 24Vdc 1758 mm pitch 120

NV2200 ■ ■ ■ A - ■

38W 24Vdc 1758 mm pitch 120

NV2201 ■ ■ ■ A - ■

■	F - 2700K 5 - 3000K 9 - 4000K
■	S - 11° M - 30° L - 45° W - 10°x40°
■	includes 1.5 m neoprene cable H05RN-F 2x0.75 Ø6.3 mm 1 - 5 m 2 - 10 m 3 - 15 m 4 - 20 m

2087 lm (3000K, 27W)
3098 lm (3000K, 38W)

1725 lm (3000K, 30°, 27W)
2415 lm (3000K, 30°, 38W)

15 power LEDs, pitch 120 mm
3-step MacAdam
50000h L90 B10 (Ta 25°C)

body in anodized anticorrosion aluminium
screen in serigraphed and transparent, tempered
extra-clear glass

not included, see p. 904

surface mounted (ceiling, wall, ground) with brackets
recessed (ceiling, wall, ground) with outer casing

see p. 204 and 205

see p. 855





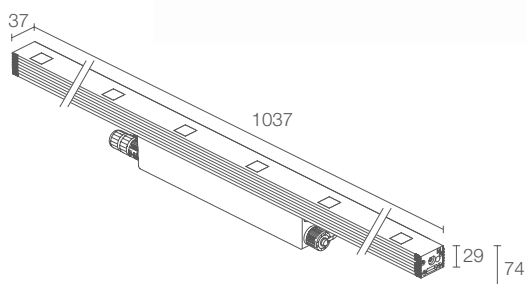

NEVA 4.1



kg 2.34 IP65 IP67 IK08

A A+ A++ 0/1-10V

24W 230Vac 1037 mm pitch 120 ON/OFF
NV4110000 ■ ■ ■ ■ ■ Anodized black

24W 230Vac 1037 mm pitch 120 0/1-10V
NV41100V0 ■ ■ ■ ■ ■ Anodized black

■	0 - not present 1 - present
■	F - 2700K 5 - 3000K 9 - 4000K
■	S - 11° M - 30° L - 45° W - 10°x40°

2313 lm (3000K)

1450 lm (3000K, 30°)

9 power LEDs, pitch 120 mm
 3-step MacAdam, 50000h L85 B10 (Ta 25°C)

body in black-anodized anticorrosional aluminium
 screen in serigraphed and transparent,
 tempered extra-clear glass

built in

surface mounted (ceiling, wall, ground) with brackets
 recessed (ceiling, wall, ground) with outer casing

see p. 204 and 205

fast installation: direct connection between
 fixture and mains power supply

see p. 856

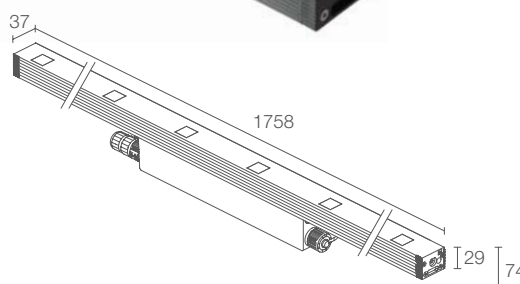

NEVA 4.2



kg 3.62 IP65 IP67 IK08

A A+ A++ 0/1-10V

40W 230Vac 1758 mm pitch 120 ON/OFF
NV4210000 ■ ■ ■ ■ ■ Anodized black

40W 230Vac 1758 mm pitch 120 0/1-10V
NV42100V0 ■ ■ ■ ■ ■ Anodized black

■	0 - not present 1 - present
■	F - 2700K 5 - 3000K 9 - 4000K
■	S - 11° M - 30° L - 45° W - 10°x40°

3855 lm (3000K)

2415 lm (3000K, 30°)

15 power LEDs, pitch 120 mm
 3-step MacAdam, 50000h L85 B10 (Ta 25°C)

body in black-anodized anticorrosional aluminium
 screen in serigraphed and transparent,
 tempered extra-clear glass

built in

surface mounted (ceiling, wall, ground) with brackets
 recessed (ceiling, wall, ground) with outer casing

see p. 204 and 205

fast installation: direct connection between
 fixture and mains power supply

see p. 856

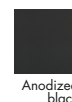

Anodized black



< **NEVA 5.2**
RGB, 50W, 24°x46°, with brackets

NEVA 2.2
3000K, 27W, 11°, with brackets

Project by / architects
Gotha Cosmetics Headquarters
Bergamo, Italy

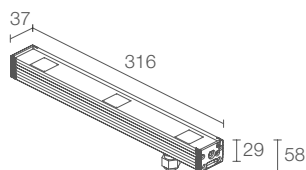

NEVA MINI 5



NEVA 5.0



POWER / POWER SUPPLY CODE

10W 24Vdc 316 mm pitch 120
NV0500 6 ■ A - ■

20W 24Vdc 677 mm pitch 120
NV5000 6 ■ A - ■

20W 24Vdc + DMX512 677 mm pitch 120
NV5001 6 ■ A

OPTICS

S - 15°
M - 26°
L - 30°
W - 24°x46°

S - 15°
M - 26°
L - 30°
W - 24°x46°

POWER CABLES

includes 1.5 m neoprene cable
05RN-F 4x0.50 Ø5.8 mm
1 - 5 m
2 - 10 m
3 - 15 m
4 - 20 m

includes 1.5 m neoprene cable 05RN-F 4x0.50 Ø5.8 mm
DMX version: includes 2x1.5 m neoprene cables
H05RN-F 2x0.75 Ø6.3 mm and 05RN-F 4x0.50 Ø5.8 mm
1 - 5 m
2 - 10 m
3 - 15 m
4 - 20 m

LED COLOUR

RGB

RGB

LUMEN OUTPUT AT SOURCE	454 lm, R: 151 lm G: 227 lm B: 76 lm
DELIVERED LUMEN OUTPUT	324 lm, R: 108 lm G: 162 lm B: 54 lm (26°)
NO. AND TYPE OF LED	3 RGB LED groups, pitch 120 mm 50000h L90 B10 (Ta 25°C)
MATERIAL	body in anodized anticorrosion aluminium screen in serigraphed and transparent, tempered extra-clear glass
POWER SUPPLY UNIT	not included, see p. 904 and 917
MOUNTING	surface mounted (ceiling, wall, ground) with brackets recessed (ceiling, wall, ground) with outer casing
ACCESSORIES	see p. 204 and 205
PHOTOMETRIC DATA	see p. 853

LUMEN OUTPUT AT SOURCE	908 lm, R: 303 lm G: 454 lm B: 151 lm
DELIVERED LUMEN OUTPUT	648 lm, R: 216 lm G: 324 lm B: 108 lm (26°)
NO. AND TYPE OF LED	6 RGB LED groups, pitch 120 mm 50000h L90 B10 (Ta 25°C)
MATERIAL	body in anodized anticorrosion aluminium screen in serigraphed and transparent, tempered extra-clear glass
POWER SUPPLY UNIT	not included, see p. 904 and 917
MOUNTING	surface mounted (ceiling, wall, ground) with brackets recessed (ceiling, wall, ground) with outer casing
ACCESSORIES	see p. 204 and 205
PHOTOMETRIC DATA	see p. 856

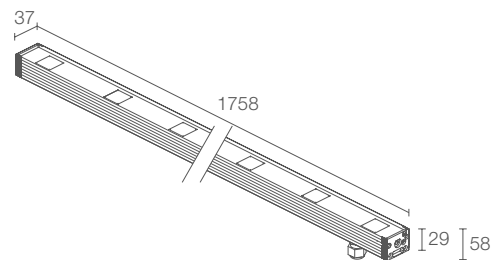
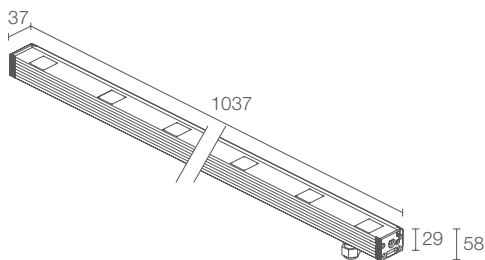

NEVA 5.1



kg 1.87 IP65 IP67 IK06

A A+ A++ NTC CASAMBI T max 45°C

30W 24Vdc 1037 mm pitch 120

NV5100 6 ■ A - ■

■ **S** - 15°
M - 26°
L - 30°
W - 24°x46°

- includes 1.5 m neoprene cable 05RN-F 4x0.50 Ø5.8 mm
- 1** - 5 m
- 2** - 10 m
- 3** - 15 m
- 4** - 20 m

RGB

1363 lm, R: 455 lm G: 681 lm B: 227 lm

972 lm, R: 324 lm G: 486 lm B: 162 lm (26°)

9 RGB LED groups, pitch 120 mm
50000h L90 B10 (Ta 25°C)

body in anodized anticorrosion aluminium
screen in serigraphed and transparent,
tempered extra-clear glass

not included, see p. 904 and 917

surface mounted (ceiling, wall, ground) with brackets
recessed (ceiling, wall, ground) with outer casing

see p. 204 and 205

see p. 856

NEVA 5.2



kg 3.15 IP65 IP67 IK06

A A+ A++ NTC CASAMBI T max 45°C

50W 24Vdc 1758 mm pitch 120

NV5200 6 ■ A - ■

■ **S** - 15°
M - 26°
L - 30°
W - 24°x46°

- includes 1.5 m neoprene cable 05RN-F 4x0.50 Ø5.8 mm
- 1** - 5 m
- 2** - 10 m
- 3** - 15 m
- 4** - 20 m

RGB

2271 lm, R: 758 lm G: 1135 lm B: 378 lm

1620 lm, R: 540 lm G: 810 lm B: 270 lm (26°)

15 RGB LED groups, pitch 120 mm
50000h L90 B10 (Ta 25°C)

body in anodized anticorrosion aluminium
screen in serigraphed and transparent,
tempered extra-clear glass

not included, see p. 904 and 917

surface mounted (ceiling, wall, ground) with brackets
recessed (ceiling, wall, ground) with outer casing

see p. 204 and 205

see p. 856

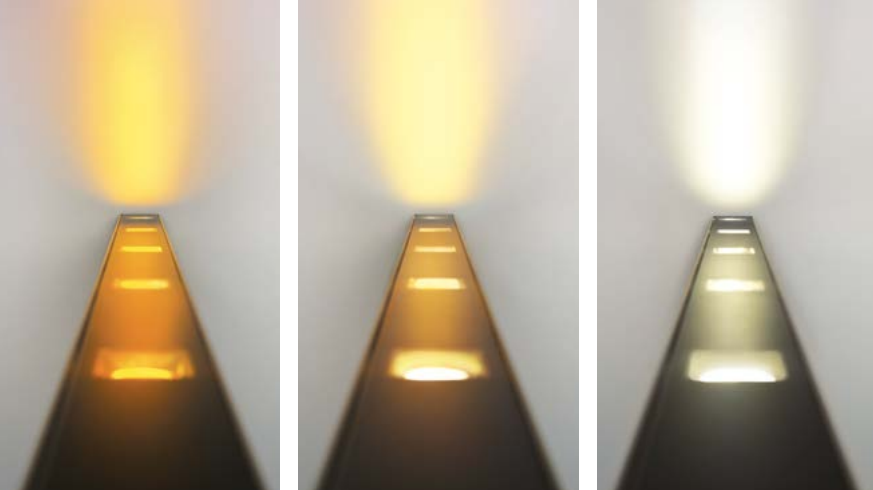

< **NEVA 6.0**
dynamic white, 20W, 24°x46°

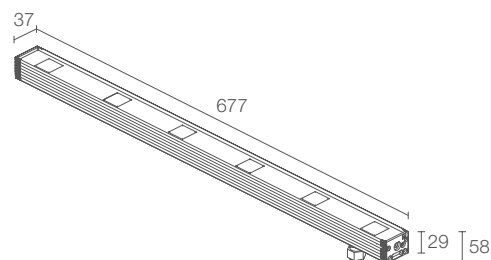
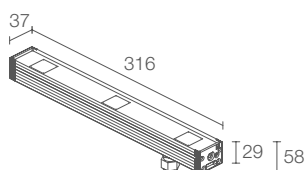

NEVA MINI 6



POWER / POWER SUPPLY CODE	10W 24Vdc 316 mm pitch 120 NV0600 H ■ A - ■
OPTICS	S - 15° M - 26° L - 30° W - 24°x46°
POWER CABLES	includes 1.5 m neoprene cable 05RN-F 4x0.50 Ø5.8 mm 1 - 5 m 2 - 10 m 3 - 15 m 4 - 20 m
LED COLOUR	dynamic white: amber, 4000K, 5000K

LUMEN OUTPUT AT SOURCE	1035 lm, amber: 258 lm 4000K: 379 lm 5000K: 398 lm (4000K)
DELIVERED LUMEN OUTPUT	737 lm, amber: 184 lm 4000K: 270 lm 5000K: 283 lm (4000K, 26°)
NO. AND TYPE OF LED	3 LED groups, pitch 120 mm 50000h L90 B10 (Ta 25°C)
MATERIAL	body in anodized anticorodal aluminium screen in serigraphed and transparent, tempered extra-clear glass
POWER SUPPLY UNIT	not included, see p. 904 and 917
MOUNTING	surface mounted (ceiling, wall, ground) with brackets recessed (ceiling, wall, ground) with outer casing
ACCESSORIES	see p. 204 and 205
PHOTOMETRIC DATA	see p. 854

NEVA 6.0



POWER / POWER SUPPLY CODE	20W 24Vdc 677 mm pitch 120 NV6000 H ■ A - ■
OPTICS	S - 15° M - 26° L - 30° W - 24°x46°
POWER CABLES	includes 1.5 m neoprene cable 05RN-F 4x0.50 Ø5.8 mm 1 - 5 m 2 - 10 m 3 - 15 m 4 - 20 m
LED COLOUR	dynamic white: amber, 4000K, 5000K

LUMEN OUTPUT AT SOURCE	2070 lm, amber: 517 lm 4000K: 758 lm 5000K: 795 lm (4000K)
DELIVERED LUMEN OUTPUT	1475 lm, amber: 368 lm 4000K: 540 lm 5000K: 567 lm (4000K, 26°)
NO. AND TYPE OF LED	6 LED groups, pitch 120 mm 50000h L90 B10 (Ta 25°C)
MATERIAL	body in anodized anticorodal aluminium screen in serigraphed and transparent, tempered extra-clear glass
POWER SUPPLY UNIT	not included, see p. 904 and 917
MOUNTING	surface mounted (ceiling, wall, ground) with brackets recessed (ceiling, wall, ground) with outer casing
ACCESSORIES	see p. 204 and 205
PHOTOMETRIC DATA	see p. 857

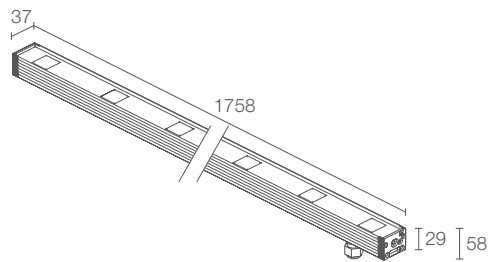
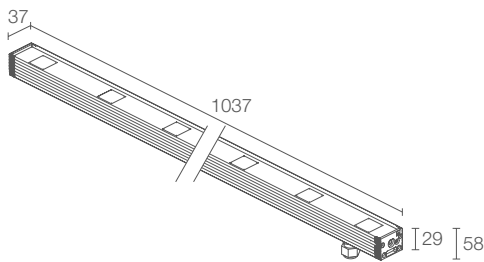
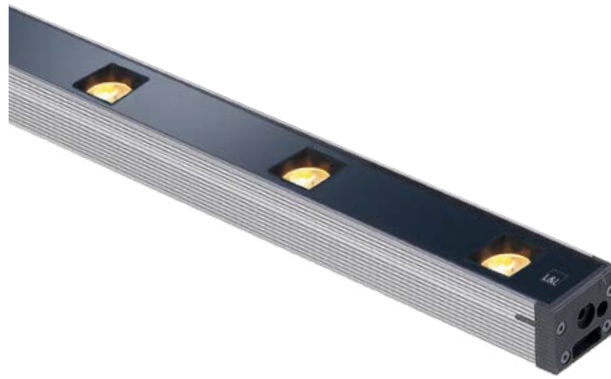

NEVA 6.1



kg 1.87 IP65 IP67 IK06

A A+ A++ NTC CASAMBI

30W 24Vdc 1037 mm pitch 120

NV6100 H ■ A - ■

- S - 15°
- M - 26°
- L - 30°
- W - 24°x46°

■ includes 1.5 m neoprene cable
05RN-F 4x0.50 Ø5.8 mm

- 1 - 5 m
- 2 - 10 m
- 3 - 15 m
- 4 - 20 m

dynamic white: amber, 4000K, 5000K

3100 lm,
amber: 774 lm 4000K: 1135 lm 5000K: 1191 lm
(4000K)

2212 lm,
amber: 552 lm 4000K: 810 lm 5000K: 850 lm
(4000K, 26°)

9 LED groups, pitch 120 mm
50000h L90 B10 (Ta 25°C)

body in anodized anticorrosional aluminium
screen in serigraphed and transparent,
tempered extra-clear glass

not included, see p. 904 and 917

surface mounted (ceiling, wall, ground) with brackets
recessed (ceiling, wall, ground) with outer casing

see p. 204 and 205

see p. 857

NEVA 6.2



kg 3.15 IP65 IP67 IK06

A A+ A++ NTC CASAMBI

50W 24Vdc 1758 mm pitch 120

NV6200 H ■ A - ■

- S - 15°
- M - 26°
- L - 30°
- W - 24°x46°

■ includes 1.5 m neoprene cable
05RN-F 4x0.50 Ø5.8 mm

- 1 - 5 m
- 2 - 10 m
- 3 - 15 m
- 4 - 20 m

dynamic white: amber, 4000K, 5000K

5162 lm,
amber: 1288 lm 4000K: 1890 lm 5000K: 1984 lm
(4000K)

3687 lm,
amber: 920 lm 4000K: 1350 lm 5000K: 1417 lm
(4000K, 26°)

15 LED groups, pitch 120 mm
50000h L90 B10 (Ta 25°C)

body in anodized anticorrosional aluminium
screen in serigraphed and transparent,
tempered extra-clear glass

not included, see p. 904 and 917

surface mounted (ceiling, wall, ground) with brackets
recessed (ceiling, wall, ground) with outer casing

see p. 204 and 205

see p. 857



< **NEVA 7.2**
RGBW, 75W, 26°x58°

Project by / SC Servizi Integrati
Torre Bassano
Torre del Greco, Naples, Italy

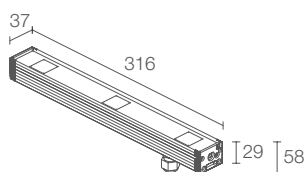

NEVA MINI 7



NEVA 7.0



POWER / POWER SUPPLY CODE	15W 24Vdc 316 mm pitch 120 NV0700 7 ■ A
OPTICS	S - 18° M - 32° L - 44° K - 78° W - 26°x58°
LED COLOUR	RGBW

POWER / POWER SUPPLY CODE	30W 24Vdc 677 mm pitch 120 NV7000 7 ■ A
OPTICS	S - 18° M - 32° L - 44° K - 78° W - 26°x58°
LED COLOUR	RGBW

LUMEN OUTPUT AT SOURCE	850 lm, R: 137 lm G: 300 lm B: 92 lm W: 321 lm (4000K)
DELIVERED LUMEN OUTPUT	525 lm, R: 84 lm G: 186 lm B: 57 lm W: 198 lm (4000K, 32°)
NO. AND TYPE OF LED	3 RGBW LED groups, pitch 120 mm 50000h L90 B10 (Ta 25°C)
MATERIAL	body in anodized anticorrosion aluminium screen in serigraphed and transparent, tempered extra-clear glass
POWER SUPPLY UNIT	not included, see p. 904 and 917
POWER CABLES	includes 1.5 m FEP+RUB cable (equivalent to H05RN-F) 6x0.50/0.50 Ø6.3 mm
MOUNTING	surface mounted (ceiling, wall, ground) with brackets recessed (ceiling, wall, ground) with outer casing
ACCESSORIES	see p. 204 and 205
PHOTOMETRIC DATA	see p. 854

LUMEN OUTPUT AT SOURCE	1699 lm, R: 273 lm G: 600 lm B: 184 lm W: 642 lm (4000K)
DELIVERED LUMEN OUTPUT	1051 lm, R: 169 lm G: 371 lm B: 114 lm W: 397 lm (4000K, 32°)
NO. AND TYPE OF LED	6 RGBW LED groups, pitch 120 mm 50000h L90 B10 (Ta 25°C)
MATERIAL	body in anodized anticorrosion aluminium screen in serigraphed and transparent, tempered extra-clear glass
POWER SUPPLY UNIT	not included, see p. 904 and 917
POWER CABLES	includes 1.5 m FEP+RUB cable (equivalent to H05RN-F) 6x0.50/0.50 Ø6.3 mm
MOUNTING	surface mounted (ceiling, wall, ground) with brackets recessed (ceiling, wall, ground) with outer casing
ACCESSORIES	see p. 204 and 205
PHOTOMETRIC DATA	see p. 857

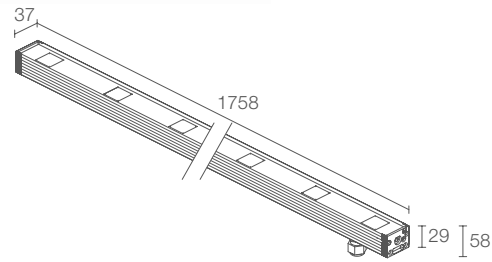
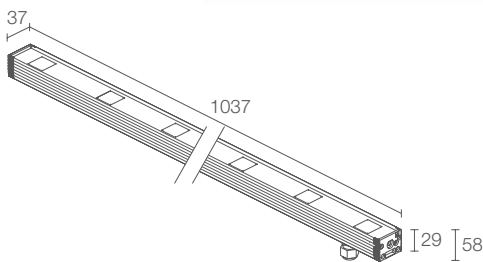
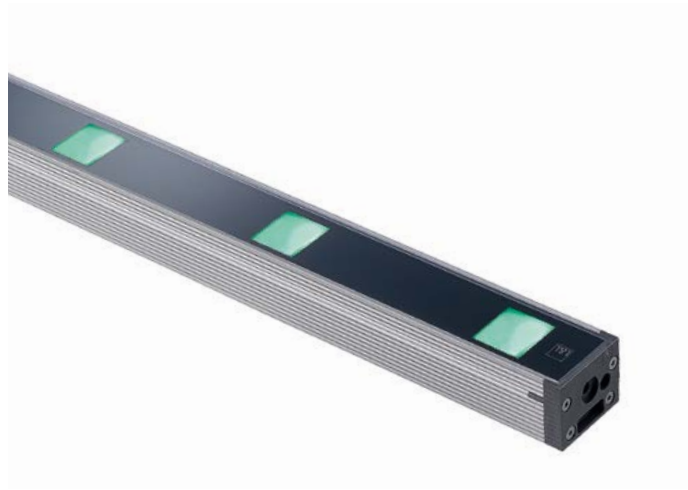

NEVA 7.1



kg 1.90 IP65 IP67 IK06

A A+ A++ **IPS** **PID** NTC CASAMBI $T_{max} 60^{\circ}C$

45W 24Vdc 1037 mm pitch 120
NV7100 7 ■ A

S - 18°
M - 32°
L - 44°
K - 78°
W - 26°x58°

RGBW

2548 lm, R: 410 lm G: 900 lm B: 275 lm
W: 963 lm (4000K)

1575 lm, R: 253 lm G: 556 lm B: 171 lm
W: 595 lm (4000K, 32°)

9 RGBW LED groups, pitch 120 mm
50000h L90 B10 (Ta 25°C)

body in anodized anticorrosion aluminium
screen in serigraphed and transparent,
tempered extra-clear glass

not included, see p. 904 and 917

includes 1.5 m FEP+RUB cable
(equivalent to H05RN-F) 6x0.50/0.50 Ø6.3 mm

surface mounted (ceiling, wall, ground) with brackets
recessed (ceiling, wall, ground) with outer casing

see p. 204 and 205

see p. 857

NEVA 7.2



kg 3.20 IP65 IP67 IK06

A A+ A++ **IPS** **PID** NTC CASAMBI $T_{max} 60^{\circ}C$

75W 24Vdc 1758 mm pitch 120
NV7200 7 ■ A

S - 18°
M - 32°
L - 44°
K - 78°
W - 26°x58°

RGBW

4247 lm, R: 683 lm G: 1500 lm B: 459 lm
W: 1605 lm (4000K)

2625 lm, R: 422 lm G: 927 lm B: 284 lm
W: 992 lm (4000K, 32°)

15 RGBW LED groups, pitch 120 mm
50000h L90 B10 (Ta 25°C)

body in anodized anticorrosion aluminium
screen in serigraphed and transparent,
tempered extra-clear glass

not included, see p. 904 and 917

includes 1.5 m FEP+RUB cable
(equivalent to H05RN-F) 6x0.50/0.50 Ø6.3 mm

surface mounted (ceiling, wall, ground) with brackets
recessed (ceiling, wall, ground) with outer casing

see p. 204 and 205

see p. 857

ANTI-GLARE ACCESSORIES



Honeycomb louvre built into the lighting fixture order together with the lighting fixture



Anti-glare shield in black-painted stainless steel

ACCESSORIES FOR INSTALLATION



Aluminium outer casing

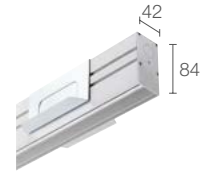

Aluminium outer casing for plasterboard

NEVA MINI 1	WH6001	WB6500 - 328 mm	WC6500 - 322 mm	WC6700 - 322 mm
NEVA 1.0	WH6010	WB6510 - 612 mm	WC6510 - 622 mm	WC6710 - 622 mm
NEVA 1.1	WH6011	WB6511 - 912 mm	WC6511 - 922 mm	WC6711 - 922 mm
NEVA 1.2	WH6012	WB6512 - 1513 mm	WC6512 - 1522 mm	WC6712 - 1522 mm
NEVA MINI 2	WH6002	WB6500 - 328 mm	WC6500 - 322 mm	WC6700 - 322 mm
NEVA 2.0	WH6020	WB6520 - 673 mm	WC6520 - 682 mm	WC6720 - 682 mm
NEVA 2.1	WH6021	WB6521 - 1033 mm	WC6521 - 1042 mm	WC6721 - 1042 mm
NEVA 2.2	WH6022	WB6522 - 1754 mm	WC6522 - 1763 mm	WC6722 - 1763 mm
NEVA 3.0		WB6510 - 612 mm	WC6510 - 622 mm	WC6710 - 622 mm
NEVA 3.1		WB6511 - 912 mm	WC6511 - 922 mm	WC6711 - 922 mm
NEVA 3.2		WB6512 - 1513 mm	WC6512 - 1522 mm	WC6712 - 1522 mm
NEVA 4.0		WB6520 - 673 mm	WC6520 - 682 mm	WC6720 - 682 mm
NEVA 4.1		WB6521 - 1033 mm	WC6521 - 1042 mm	WC6721 - 1042 mm
NEVA 4.2		WB6522 - 1754 mm	WC6522 - 1763 mm	WC6722 - 1763 mm
NEVA MINI 5	WH6002	WB6500 - 328 mm	WC6500 - 322 mm	WC6700 - 322 mm
NEVA 5.0	WH6020	WB6520 - 673 mm	WC6520 - 682 mm	WC6720 - 682 mm
NEVA 5.1	WH6021	WB6521 - 1033 mm	WC6521 - 1042 mm	WC6721 - 1042 mm
NEVA 5.2	WH6022	WB6522 - 1754 mm	WC6522 - 1763 mm	WC6722 - 1763 mm
NEVA MINI 6	WH6002	WB6500 - 328 mm	WC6500 - 322 mm	WC6700 - 322 mm
NEVA 6.0	WH6020	WB6520 - 673 mm	WC6520 - 682 mm	WC6720 - 682 mm
NEVA 6.1	WH6021	WB6521 - 1033 mm	WC6521 - 1042 mm	WC6721 - 1042 mm
NEVA 6.2	WH6022	WB6522 - 1754 mm	WC6522 - 1763 mm	WC6722 - 1763 mm
NEVA MINI 7		WB6500 - 328 mm	WC6500 - 322 mm	WC6700 - 322 mm
NEVA 7.0		WB6520 - 673 mm	WC6520 - 682 mm	WC6720 - 682 mm
NEVA 7.1		WB6521 - 1033 mm	WC6521 - 1042 mm	WC6721 - 1042 mm
NEVA 7.2		WB6522 - 1754 mm	WC6522 - 1763 mm	WC6722 - 1763 mm

for spare parts, see p. 933

ACCESSORIES

ACCESSORIES FOR INSTALLATION



WMO601
Pair of brackets h 75 mm
(Neva 1 / 2 / 5 / 6 / 7)



WMO602
Pair of brackets h 140 mm
(Neva 1 / 2 / 5 / 6 / 7)



WMA01N
Pair of brackets h 75 mm
(Neva 3 / 4)



WMA02N
Pair of brackets h 140 mm
(Neva 3 / 4)



WN6001
Anti-fall kit



WN6005
Alignment kit
for outer casings



WFA00
2-pin male connector
for in/out connection
(on/off version) - IP68
(Neva 3 / 4)



WFA01
4-pin male connector
for in/out connection
(0/1-10V version) - IP68
(Neva 3.0 / 3.1 /
4.0 / 4.1 / 4.2)



Spor 1-4

Holmestrand stasjon

OUTDOOR LINEAR PROFILES FOR RECESSED LINES OF CONTINUOUS LIGHT

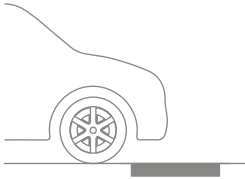

OUTDOOR



diffuse



260 mm



WIDTH 20 mm

RIO 1.0 p. 211
white light: 3W 24Vdc
RGB light: 4.5W 24Vdc



WIDTH 37 mm

RIO 2.0 p. 215
white light: 5W 24Vdc
RGB light: 4.5W 24Vdc

510 mm



RIO 1.1 p. 211
white light: 6W 24Vdc
RGB light: 8.5W 24Vdc

RIO 2.1 p. 215
white light: 10W 24Vdc
RGB light: 8.5W 24Vdc

1010 mm

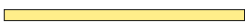

RIO 1.2 p. 212
white light: 12W 24Vdc
RGB light: 17W 24Vdc

RIO 2.2 p. 216
white light: 19W 24Vdc
RGB light: 17W 24Vdc

1510 mm

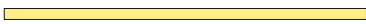

RIO 1.3 p. 213
white light: 18W 24Vdc
RGB light: 26W 24Vdc

RIO 2.3 p. 217
white light: 29W 24Vdc
RGB light: 26W 24Vdc

2010 mm

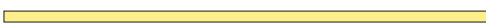

RIO 1.4 p. 213
white light: 24W 24Vdc
RGB light: 34W 24Vdc

RIO 2.4 p. 217
white light: 38W 24Vdc
RGB light: 34W 24Vdc

UNDERWATER

RIO SUB p. 770

< RIO 2
2800K, 19W/m

Light planning by / Rambøll Norge AS
Delivered by / SML Lighting AS
Executed by / Anleggsselektro AS
Architecture / Gottlieb Paludan Architects
Holmestrand Station
Holmestrand, Norway



BUILT-IN PROTECTION SYSTEMS:
IPS
INTELLIGENT PROTECTION SYSTEM



BUILT-IN TEMPERATURE
SENSOR, AND THERMAL
MANAGEMENT IN CEM3



IK10
BODY AND SCREEN IN
PMMA TO GUARANTEE
HIGH RESISTANCE



RGB VERSION



DRIVE-OVER UP TO 5000 KG
(WITH ALUMINIUM OUTER CASING)



IP67
SUITABLE FOR OUTDOOR APPLICATIONS



OUTDOOR VERSION
(Positano, Salerno, Italy)

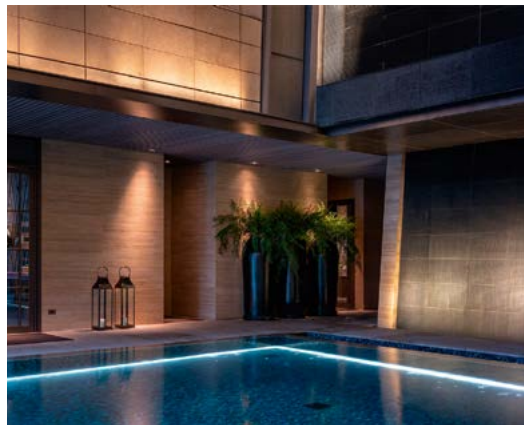

UNDERWATER VERSION:
RIO SUB, P. 770
(Rosewood Hotel, Bangkok, Thailand)

UNIQUE SELLING POINTS



ALUMINIUM
OUTER CASING



STAINLESS STEEL
OUTER CASING



ALUMINIUM
OUTER CASING FOR
PLASTERBOARD



NON-STANDARD
LENGTHS AVAILABLE
ON REQUEST



RECESSED MOUNTING IN
CEILING, WALL OR GROUND
USING SPECIAL OUTER CASING
AND INSTALLATION KIT

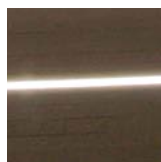

NO DARK ZONE
BETWEEN FIXTURES



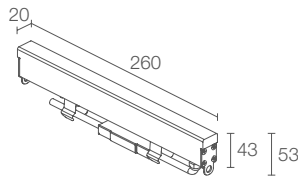

RIO 1.0



POWER / POWER SUPPLY	3W 24Vdc white light 260 mm 4.5W 24Vdc RGB light 260 mm
CODE	RE1000 ■ D B - ■
LED COLOUR	F - 2600K 5 - 2800K 9 - 3700K 6 - RGB
POWER CABLES	includes 1.5 m neoprene cable H05RN-F 2x0.35/0.75 Ø6.3 mm RGB: includes 1.5 m FEP+PCP cable (equivalent to H05RN-F) 4x0.50/0.50 Ø6.3 mm 1 - 5 m 2 - 10 m (only white light) 3 - 15 m (only white light) 4 - 20 m (only white light)
OPTICS	diffuse
LUMEN OUTPUT AT SOURCE	336 lm (2800K) RGB: 70 lm, R: 15 lm G: 45 lm B: 10 lm
DELIVERED LUMEN OUTPUT	70 lm (2800K) RGB: 50 lm, R: 11 lm G: 32 lm B: 7 lm
NO. AND TYPE OF LED	24 low-power SMD LEDs 3-step MacAdam RGB: full-colour SMD LEDs 50000h L95 B10 (Ta 25°C)
MATERIAL	body in PMMA screen in opal PMMA end caps in AISI 316L stainless steel
POWER SUPPLY UNIT	not included, see p. 904 and 917
MOUNTING	recessed (ceiling, wall, ground)
ACCESSORIES	see p. 219
NOTES	underwater version: Rio Sub 1, p. 772 non-standard lengths available on request
PHOTOMETRIC DATA	see p. 870

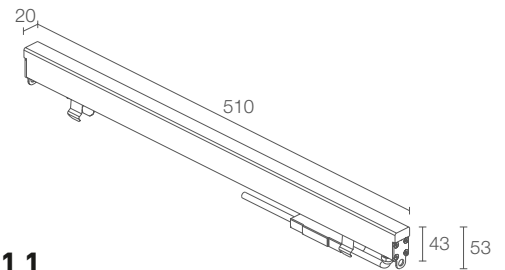
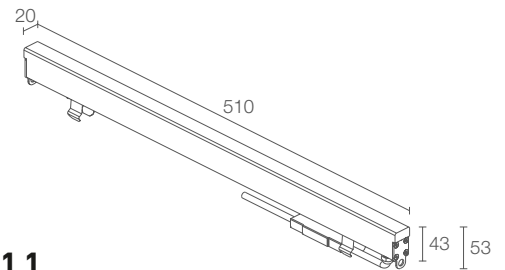

RIO 1.1



POWER / POWER SUPPLY	6W 24Vdc white light 510 mm 8.5W 24Vdc RGB light 510 mm
CODE	RE1100 ■ D B - ■
LED COLOUR	F - 2600K 5 - 2800K 9 - 3700K 6 - RGB
POWER CABLES	includes 1.5 m neoprene cable H05RN-F 2x0.35/0.75 Ø6.3 mm RGB: includes 1.5 m FEP+PCP cable (equivalent to H05RN-F) 4x0.50/0.50 Ø6.3 mm 1 - 5 m 2 - 10 m (only white light) 3 - 15 m (only white light) 4 - 20 m (only white light)
OPTICS	diffuse
LUMEN OUTPUT AT SOURCE	672 lm (2800K) RGB: 140 lm, R: 30 lm G: 90 lm B: 20 lm
DELIVERED LUMEN OUTPUT	140 lm (2800K) RGB: 100 lm, R: 22 lm G: 64 lm B: 14 lm
NO. AND TYPE OF LED	48 low-power SMD LEDs 3-step MacAdam RGB: full-colour SMD LEDs 50000h L95 B10 (Ta 25°C)
MATERIAL	body in PMMA screen in opal PMMA end caps in AISI 316L stainless steel
POWER SUPPLY UNIT	not included, see p. 904 and 917
MOUNTING	recessed (ceiling, wall, ground)
ACCESSORIES	see p. 219
NOTES	underwater version: Rio Sub 1, p. 772 non-standard lengths available on request
PHOTOMETRIC DATA	see p. 870

< **RIO 1.2**
2800K, 12W

Light planning by / Alve Iluminación
Plaza del Parrote, A Coruña, Spain

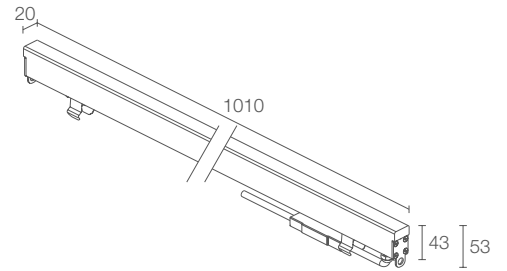

RIO 1.2



POWER / POWER SUPPLY	12W 24Vdc white light 1010 mm 17W 24Vdc RGB light 1010 mm
CODE	RE1200 ■ D B - ■
LED COLOUR	F - 2600K 5 - 2800K 9 - 3700K 6 - RGB
POWER CABLES	includes 1.5 m neoprene cable H05RN-F 2x0.35/0.75 Ø6.3 mm RGB: includes 1.5 m FEP+PCP cable (equivalent to H05RN-F) 4x0.50/0.50 Ø6.3 mm 1 - 5 m 2 - 10 m (only white light) 3 - 15 m (only white light) 4 - 20 m (only white light)
OPTICS	diffuse
LUMEN OUTPUT AT SOURCE	1344 lm (2800K) RGB: 280 lm R: 60 lm G: 180 lm B: 40 lm
DELIVERED LUMEN OUTPUT	280 lm (2800K) RGB: 200 lm R: 44 lm G: 128 lm B: 28 lm
NO. AND TYPE OF LED	96 low-power SMD LEDs 3-step MacAdam RGB: full-colour SMD LEDs 50000h L95 B10 (Ta 25°C)
MATERIAL	body in PMMA screen in opal PMMA end caps in AISI 316L stainless steel
POWER SUPPLY UNIT	not included, see p. 904 and 917
MOUNTING	recessed (ceiling, wall, ground)
ACCESSORIES	see p. 219
NOTES	underwater version: Rio Sub 1, p. 772 non-standard lengths available on request
PHOTOMETRIC DATA	see p. 870

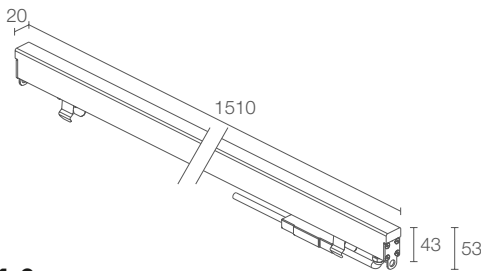

RIO 1.3



18W 24Vdc white light 1510 mm
26W 24Vdc RGB light 1510 mm
RE1300 ■ D B - ■

- F - 2600K
- 5 - 2800K
- 9 - 3700K
- 6 - RGB

■ includes 1.5 m neoprene cable
H05RN-F 2x0.35/0.75 Ø6.3 mm
RGB: includes 1.5 m FEP+PCP cable
(equivalent to H05RN-F) 4x0.50/0.50 Ø6.3 mm
1 - 5 m
2 - 10 m (only white light)
3 - 15 m (only white light)
4 - 20 m (only white light)

diffuse

2016 lm (2800K)
RGB: 420 lm, R: 90 lm G: 270 lm B: 60 lm

420 lm (2800K)
RGB: 300 lm, R: 66 lm G: 192 lm B: 42 lm

144 low-power SMD LEDs
3-step MacAdam
RGB: full-colour SMD LEDs
50000h L95 B10 (Ta 25°C)

body in PMMA
screen in opal PMMA
end caps in AISI 316L stainless steel

not included, see p. 904 and 917

recessed (ceiling, wall, ground)

see p. 219

underwater version: Rio Sub 1, p. 772
non-standard lengths available on request

see p. 870

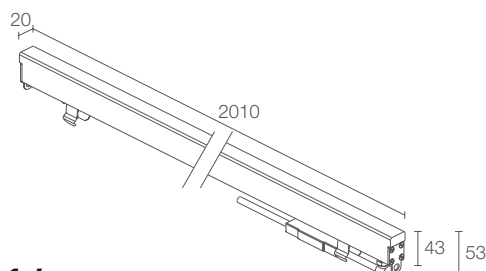

RIO 1.4



24W 24Vdc white light 2010 mm
34W 24Vdc RGB light 2010 mm
RE1400 ■ D B - ■

- F - 2600K
- 5 - 2800K
- 9 - 3700K
- 6 - RGB

■ includes 1.5 m neoprene cable
H05RN-F 2x0.35/0.75 Ø6.3 mm
RGB: includes 1.5 m FEP+PCP cable
(equivalent to H05RN-F) 4x0.50/0.50 Ø6.3 mm
1 - 5 m
2 - 10 m (only white light)
3 - 15 m (only white light)
4 - 20 m (only white light)

diffuse

2688 lm (2800K)
RGB: 560 lm, R: 120 lm G: 360 lm B: 80 lm

560 lm (2800K)
RGB: 400 lm, R: 88 lm G: 256 lm B: 56 lm

192 low-power SMD LEDs
3-step MacAdam
RGB: full-colour SMD LEDs
50000h L95 B10 (Ta 25°C)

body in PMMA
screen in opal PMMA
end caps in AISI 316L stainless steel

not included, see p. 904 and 917

recessed (ceiling, wall, ground)

see p. 219

underwater version: Rio Sub 1, p. 772
non-standard lengths available on request

see p. 870



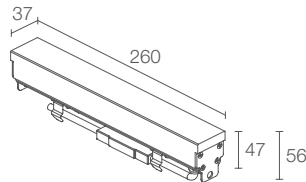

RIO 2.0



POWER / POWER SUPPLY	5W 24Vdc white light 260 mm 4.5W 24Vdc RGB light 260 mm
CODE	RE2000 ■ D B - ■
LED COLOUR	F - 2600K 5 - 2800K 9 - 3700K 6 - RGB
POWER CABLES	includes 1.5 m neoprene cable H05RN-F 2x0.35/0.75 Ø6.3 mm RGB: includes 1.5 m FEP+PCP cable (equivalent to H05RN-F) 4x0.50/0.50 Ø6.3 mm 1 - 5 m 2 - 10 m (only white light) 3 - 15 m (only white light) 4 - 20 m (only white light)
OPTICS	diffuse

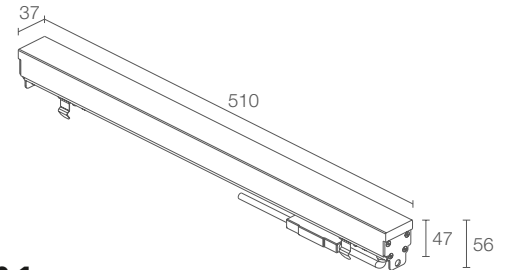
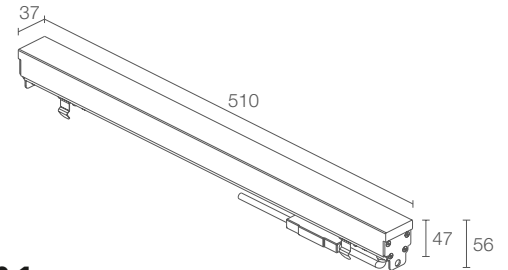

RIO 2.1



POWER / POWER SUPPLY	10W 24Vdc white light 510 mm 8.5W 24Vdc RGB light 510 mm
CODE	RE2100 ■ D B - ■
LED COLOUR	F - 2600K 5 - 2800K 9 - 3700K 6 - RGB
POWER CABLES	includes 1.5 m neoprene cable H05RN-F 2x0.35/0.75 Ø6.3 mm RGB: includes 1.5 m FEP+PCP cable (equivalent to H05RN-F) 4x0.50/0.50 Ø6.3 mm 1 - 5 m 2 - 10 m (only white light) 3 - 15 m (only white light) 4 - 20 m (only white light)
OPTICS	diffuse

LUMEN OUTPUT AT SOURCE	528 lm (2800K) RGB: 70 lm, R: 15 lm G: 45 lm B: 10 lm
DELIVERED LUMEN OUTPUT	145 lm (2800K) RGB: 50 lm, R: 11 lm G: 32 lm B: 7 lm
NO. AND TYPE OF LED	48 low-power SMD LEDs 3-step MacAdam RGB: full-colour SMD LEDs 50000h L95 B10 (Ta 25°C)
MATERIAL	body in PMMA screen in opal PMMA end caps in AISI 316L stainless steel
POWER SUPPLY UNIT	not included, see p. 904 and 917
MOUNTING	recessed (ceiling, wall, ground)
ACCESSORIES	see p. 219
NOTES	underwater version: Rio Sub 2, p. 773 non-standard lengths available on request
PHOTOMETRIC DATA	see p. 870

LUMEN OUTPUT AT SOURCE	1056 lm (2800K) RGB: 140 lm, R: 30 lm G: 90 lm B: 20 lm
DELIVERED LUMEN OUTPUT	290 lm (2800K) RGB: 100 lm, R: 22 lm G: 64 lm B: 14 lm
NO. AND TYPE OF LED	96 low-power SMD LEDs 3-step MacAdam RGB: full-colour SMD LEDs 50000h L95 B10 (Ta 25°C)
MATERIAL	body in PMMA screen in opal PMMA end caps in AISI 316L stainless steel
POWER SUPPLY UNIT	not included, see p. 904 and 917
MOUNTING	recessed (ceiling, wall, ground)
ACCESSORIES	see p. 219
NOTES	underwater version: Rio Sub 2, p. 773 non-standard lengths available on request
PHOTOMETRIC DATA	see p. 870

< **RIO 2**
2800K, 19W/m, version with customized lengths

Project by / AWP
Light planning by / 8'18''
Jardins de l'Arche, Paris, France

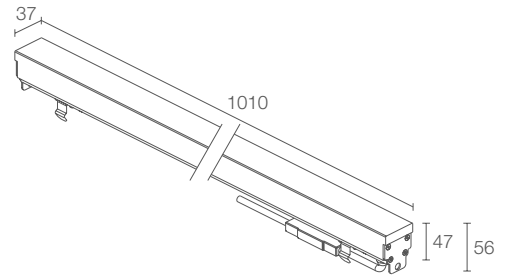

RIO 2.2

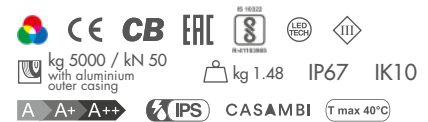

POWER / POWER SUPPLY	19W 24Vdc white light 1010 mm 17W 24Vdc RGB light 1010 mm
CODE	RE2200 ■ D B - ■
LED COLOUR	F - 2600K 5 - 2800K 9 - 3700K 6 - RGB
POWER CABLES	includes 1.5 m neoprene cable H05RN-F 2x0.35/0.75 Ø6.3 mm RGB: includes 1.5 m FEP+PCP cable (equivalent to H05RN-F) 4x0.50/0.50 Ø6.3 mm 1 - 5 m 2 - 10 m (only white light) 3 - 15 m (only white light) 4 - 20 m (only white light)
OPTICS	diffuse
LUMEN OUTPUT AT SOURCE	2112 lm (2800K) RGB: 280 lm, R: 60 lm G: 180 lm B: 40 lm
DELIVERED LUMEN OUTPUT	580 lm (2800K) RGB: 200 lm, R: 44 lm G: 128 lm B: 28 lm
NO. AND TYPE OF LED	192 low-power SMD LEDs 3-step MacAdam RGB: full-colour SMD LEDs 50000h L95 B10 (Ta 25°C)
MATERIAL	body in PMMA screen in opal PMMA end caps in AISI 316L stainless steel
POWER SUPPLY UNIT	not included, see p. 904 and 917
MOUNTING	recessed (ceiling, wall, ground)
ACCESSORIES	see p. 219
NOTES	underwater version: Rio Sub 2, p. 773 non-standard lengths available on request
PHOTOMETRIC DATA	see p. 870

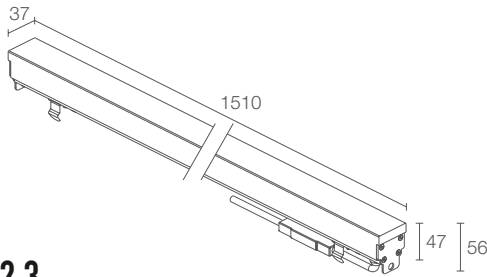

RIO 2.3



29W 24Vdc white light 1510 mm
26W 24Vdc RGB light 1510 mm
RE2300 ■ D B - ■

■ **F** - 2600K
5 - 2800K
9 - 3700K
6 - RGB

■ includes 1.5 m neoprene cable H05RN-F 2x0.35/0.75 Ø6.3 mm
RGB: includes 1.5 m FEP+PCP cable (equivalent to H05RN-F) 4x0.50/0.50 Ø6.3 mm
1 - 5 m
2 - 10 m (only white light)
3 - 15 m (only white light)
4 - 20 m (only white light)

diffuse

3168 lm (2800K)
RGB: 420 lm, R: 90 lm G: 270 lm B: 60 lm

870 lm (2800K)
RGB: 300 lm, R: 66 lm G: 192 lm B: 42 lm

288 low-power SMD LEDs
3-step MacAdam
RGB: full-colour SMD LEDs
50000h L95 B10 (Ta 25°C)

body in PMMA
screen in opal PMMA
end caps in AISI 316L stainless steel

not included, see p. 904 and 917

recessed (ceiling, wall, ground)

see p. 219

underwater version: Rio Sub 2, p. 773
non-standard lengths available on request

see p. 870

RIO 2.4

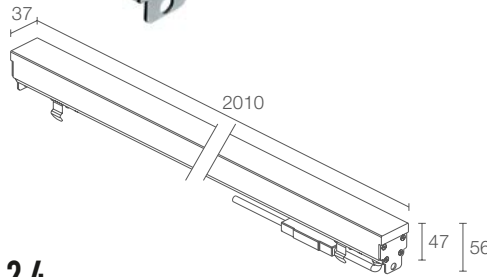

38W 24Vdc white light 2010 mm
34W 24Vdc RGB light 2010 mm
RE2400 ■ D B - ■

■ **F** - 2600K
5 - 2800K
9 - 3700K
6 - RGB

■ includes 1.5 m neoprene cable H05RN-F 2x0.35/0.75 Ø6.3 mm
RGB: includes 1.5 m FEP+PCP cable (equivalent to H05RN-F) 4x0.50/0.50 Ø6.3 mm
1 - 5 m
2 - 10 m (only white light)
3 - 15 m (only white light)
4 - 20 m (only white light)

diffuse

4224 lm (2800K)
RGB: 560 lm, R: 120 lm G: 360 lm B: 80 lm

1160 lm (2800K)
RGB: 400 lm, R: 88 lm G: 256 lm B: 56 lm

384 low-power SMD LEDs
3-step MacAdam
RGB: full-colour SMD LEDs
50000h L95 B10 (Ta 25°C)

body in PMMA
screen in opal PMMA
end caps in AISI 316L stainless steel

not included, see p. 904 and 917

recessed (ceiling, wall, ground)

see p. 219

underwater version: Rio Sub 2, p. 773
non-standard lengths available on request

see p. 870



Salvatore Ferragamo Salvatore Ferragamo

ACCESSORIES

ACCESSORIES FOR INSTALLATION



Aluminium outer casing

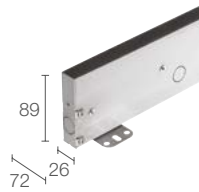

Stainless steel outer casing

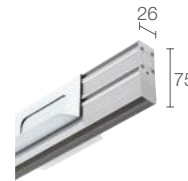

Aluminium outer casing for plasterboard

RIO 1.0	WC8110 - 264 mm	WC8150 - 263 mm	WC8310 - 264 mm
RIO 1.1	WC8111 - 514 mm	WC8151 - 513 mm	WC8311 - 514 mm
RIO 1.2	WC8112 - 1014 mm	WC8152 - 1013 mm	WC8312 - 1014 mm
RIO 1.3	WC8113 - 1515 mm	WC8153 - 1514 mm	WC8313 - 1515 mm
RIO 1.4	WC8114 - 2015 mm	WC8154 - 2014 mm	WC8314 - 2015 mm



Aluminium outer casing

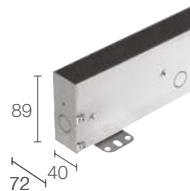

Stainless steel outer casing

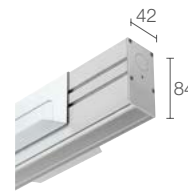

Aluminium outer casing for plasterboard

RIO 2.0	WC8220 - 264 mm	WC8250 - 263 mm	WC8420 - 264 mm
RIO 2.1	WC8221 - 514 mm	WC8251 - 513 mm	WC8421 - 514 mm
RIO 2.2	WC8222 - 1014 mm	WC8252 - 1013 mm	WC8422 - 1014 mm
RIO 2.3	WC8223 - 1515 mm	WC8253 - 1514 mm	WC8423 - 1515 mm
RIO 2.4	WC8224 - 2015 mm	WC8254 - 2014 mm	WC8424 - 2015 mm

for spare parts, see p. 933

ACCESSORIES FOR INSTALLATION



WN8101
Anti-fall kit
(Rio 1)



WN8102
Anti-fall kit
(Rio 2)



WN6005
Alignment kit for
aluminium outer casings



WN8011
Alignment kit for
stainless steel outer casings

< **RIO 2**
3700K, 19W/m, version with customized lengths
Project by / Salvatore Ferragamo HQ Store planning
Light planning by / Salvatore Ferragamo HQ Store planning
in association with Flux cs Studio
Salvatore Ferragamo Tokyo Ginza Flagship Store, Tokyo, Japan





PROJECTORS FOR OUTDOOR APPLICATIONS

ARCHITECTURAL AND GREEN SPACES

GINKO p. 224 **1**

PIVOT p. 240 **2**

DUOMO p. 252 **3**

SIRI p. 260 **4**

SPOT p. 272 **5**

FLORI p. 282 **6**

















STRA P p. 290 **7**

LYSS p. 294 **8**

AKRO p. 304 **9**



ARCHITECTURAL AND GREEN SPACES

		BEAM	LIGHT COLOUR	ADJUSTABILITY
GINKO see p. 224 GREEN SPACES AND FACADES		FIXED FOCUS ZOOM LENS	2700K 3000K 4000K RGB	
PIVOT see p. 240 ARCHITECTURAL DETAILS		FIXED FOCUS	2700K 3000K 4000K RGB	
DUOMO see p. 252 ARCADES, NAVES, CLOISTERS		FIXED FOCUS	2700K 3000K 4000K	
SIRI see p. 260 FACADES		FIXED FOCUS	2700K 3000K 4000K RGBW	
SPOT see p. 272 DETAILS AND FACADES		FIXED FOCUS	2700K 3000K 4000K 5000K blue	
FLORI see p. 282 GREEN SPACES		FIXED FOCUS	2700K 3000K 4000K RGBW	
STRA P see p. 290 LARGE BUILDINGS		FIXED FOCUS	2700K 3000K 4000K RGBW	
LYSS see p. 294 ARCHITECTURAL DETAILS		BLADE OF LIGHT	2700K 3000K 4000K blue RGBW	
AKRO see p. 304 LIGHTING EFFECTS		ZOOM LENS	2700K 3000K 4000K	



PROJECTORS FOR OUTDOOR APPLICATIONS

POWER SUPPLY	CONTROL SYSTEM	IP	APPLIANCE CLASS	UNIQUE SELLING POINTS
CONSTANT CURRENT (power supply unit not included) max 500mA (RGB light) CONSTANT VOLTAGE (power supply unit not included) 24Vdc (white light)		IP66		shadow-effect filter IP69K
CONSTANT CURRENT (power supply unit not included) max 500mA (RGB light) CONSTANT VOLTAGE (power supply unit not included) 24Vdc (white light)		IP66		
MAINS VOLTAGE (built-in power supply unit) 230Vac	DALI+PUSH	IP54		
CONSTANT VOLTAGE (power supply unit not included) 24Vdc (RGBW light) MAINS VOLTAGE (built-in power supply unit) 230Vac (white light)	0/1-10V	IP66		
CONSTANT CURRENT (power supply unit not included) max 500mA CONSTANT VOLTAGE (power supply unit not included) 24Vdc MAINS VOLTAGE (built-in power supply unit) 230Vac		IP66 IP68		
CONSTANT VOLTAGE (power supply unit not included) 24Vdc (RGBW light) MAINS VOLTAGE (built-in power supply unit) 230Vac (white light)		IP66		
CONSTANT VOLTAGE (power supply unit not included) 24Vdc (RGBW light) MAINS VOLTAGE (built-in power supply unit) 230Vac (white light)	0/1-10V	IP66		
CONSTANT VOLTAGE (power supply unit not included) 24Vdc (white/blue/RGBW light) MAINS VOLTAGE (built-in power supply unit) 230Vac (white/blue light)		IP65		
CONSTANT CURRENT (power supply unit not included) max 1050mA MAINS VOLTAGE (built-in power supply unit) 230Vac	DALI+PUSH 0/1-10V	IP66		interchangeable optical filters





OUTDOOR PROJECTORS VERSATILE LIGHT FOR ENHANCING GREEN AREAS

2700K 3000K 4000K

Ø34 mm

Ø54 mm

Ø84 mm

Ø109 mm

FIXED FOCUS

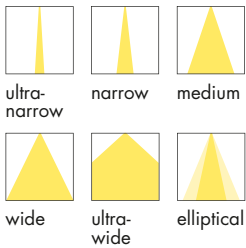

GINKO 1.0 p. 229
2.5W/3.5W
24Vdc



GINKO 2.0 p. 230
3.5W/5W/7W
24Vdc



GINKO 3.0 p. 234
10W/15W
24Vdc



GINKO 4.0 p. 237
25W
24Vdc



GINKO 2.2 p. 231
max 5W
max 500mA

ZOOM LENS

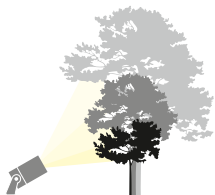

GINKO 1.4 p. 229
3.5W
24Vdc



GINKO 2.4 p. 231
7W
24Vdc



GINKO 3.4 p. 235
15W
24Vdc

5°

8°

11°

17°

21° sharp

34°

45°

47°

61° sharp

68°

13°x52°

54°x15°



IP66
SUITABLE FOR OUTDOOR APPLICATIONS



IP69K
RESISTANT TO CLEANING WITH HIGH-PRESSURE,
HIGH-TEMPERATURE SPRAY-DOWNS (ISO 20653 COMPLIANT)



BUILT-IN PROTECTION SYSTEMS:
IPS
INTELLIGENT PROTECTION SYSTEM



PID
PROTECTIVE IMPEDANCE DEVICE



CRI 80 AND CRI >90 VERSIONS
FOR IMPROVED COLOUR RENDERING



6-STEP MATERIAL PROTECTION, OXIDATION
AND CORROSION RESISTANCE

Low-copper-content anticorrosional aluminium alloy 6082
Preparation for painting
Epoxy paint
Polyester paint
Paints compliant with Qualicoat automotive coating standard
Salt spray tested (over 1500 hours)



IK07 (GINKO 1/2)



IK08 (GINKO 4)



IK09 (GINKO 3)

TRANSPARENT EXTRA-CLEAR GLASS,
UP TO 5 MM THICK AND TEMPERED FOR EXCELLENT
RESISTANCE TO KNOCKS AND SCRATCHES.
HIGH-TRANSMITTANCE VITRIFIED SERIGRAPHY
ENSURES CHROMATIC UNIFORMITY

BODY AND TRIM IN AISI 316L STAINLESS STEEL
OR IN LOW-COPPER-CONTENT ANTICORROSIONAL
ALUMINIUM ALLOY 6082 FOR EXCELLENT RESISTANCE
TO CORROSION, MADE ENTIRELY ON A CNC LATHE.
BRACKET IN AISI 316L STAINLESS STEEL



GINKO 3.0 / 3.4: ELLIPTICAL OPTICS, ADJUSTABLE
MANUALLY THROUGH 360° USING MAGNET

<

GINKO 2 HAS A WIDE RANGE OF OPTICS, INCLUDING
A VERY NARROW 5°, AND ELLIPTICAL OPTICS.
SHARP OPTICS ARE ALSO AVAILABLE, WHICH
CREATE LIGHT BEAMS WITH PIN-SHARP EDGES



UNIQUE SELLING POINTS



RAL FINISH
ON REQUEST



JASPER GREEN FINISH DEVELOPED SPECIFICALLY FOR USE IN LANDSCAPE DESIGN



STAINLESS STEEL



WHITE



ANODIZED BLACK



GREY



ANTHRACITE



COR-TEN



CABLE GLAND INTEGRATED IN LIGHTING FIXTURE



FLEXIBLE CABLE-PROTECTION TUBE ACCESSORY (GINKO 1 / 2)



ANTI-GLARE RECESSED OPTICS

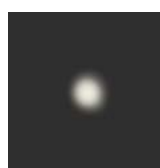

5° OPTICS TO DIRECT THE BEAM ONTO SMALL SURFACES EVEN AT GREAT DISTANCES



THE SHADOW-EFFECT FILTER ACCESSORY RECREATES THE NATURAL DAPPLED EFFECT OF LIGHT SHINING THROUGH FOLIAGE



MANUAL ZOOM LENS TO ALLOW THE BEAM TO BE CONTROLLED MANUALLY AFTER INSTALLATION



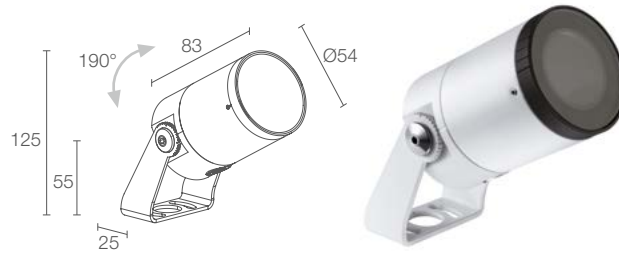
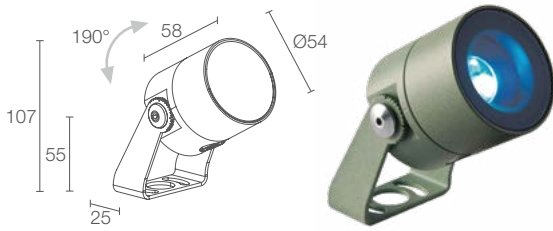

GINKO 2.2



kg 0.45 IP66 IP69K IK07

A A+ A++ IPS CASAMBI

max 500mA

- GN2232 6** ■ I - Stainless steel
- GN2232 6** ■ E - White
- GN2232 6** ■ N - Anodized black
- GN2232 6** ■ F - Grey
- GN2232 6** ■ H - Anthracite
- GN2232 6** ■ T - Cor-ten
- GN2232 6** ■ 5 - Jasper green

max 5W

RGB

- **S** - 20°
- **M** - 34°
- **L** - 45°
- **W** - 21°x42°
- **X** - 42°x21°

- includes 1.5 m FEP+RUB cable (equivalent to H05RN-F) 6x0.50/0.50 Ø6.3 mm
- **1** - 5 m
- **2** - 10 m
- **3** - 15 m
- **4** - 20 m

253 lm, R: 82 lm G: 114 lm B: 57 lm (500mA)

191 lm, R: 70 lm G: 90 lm B: 31 lm (500mA, 34°)

3 power LEDs
50000h L90 B10 (Ta 25°C)

body in AISI 316L stainless steel
or anticorrosion aluminium
bracket in AISI 316L stainless steel
screen in serigraphed and transparent,
tempered extra-clear glass

not included, see p. 904 and 917

series

surface mounted (ceiling, wall, ground, spike, strap)

see p. 238 and 239

see p. 834

GINKO 2.4



kg 0.45 IP66 IK07

A A+ A++ IPS PID CASAMBI

24Vdc

- GN2401** ■ R1 E - White
- GN2401** ■ R1 N - Anodized black
- GN2401** ■ R1 F - Grey
- GN2401** ■ R1 H - Anthracite
- GN2401** ■ R1 T - Cor-ten
- GN2401** ■ R1 5 - Jasper green

7W

- **0** - CRI 80
- **1** - CRI >90

- **F** - 2700K
- **5** - 3000K
- **9** - 4000K

optical range 9°-36°

- includes 1.5 m neoprene cable H05RN-F 2x0.75/0.75 Ø6.3 mm
- **1** - 5 m
- **2** - 10 m
- **3** - 15 m
- **4** - 20 m

657 lm (3000K, CRI 80)

122 lm (3000K, 36°, CRI 80)

1 high-intensity power LED
3-step MacAdam, 50000h L90 B10 (Ta 25°C)

body in anticorrosion aluminium
bracket in AISI 316L stainless steel
screen in serigraphed and transparent,
tempered extra-clear glass

not included, see p. 904

parallel

surface mounted (ceiling, wall, ground, spike, strap)

see p. 238 and 239

see p. 834







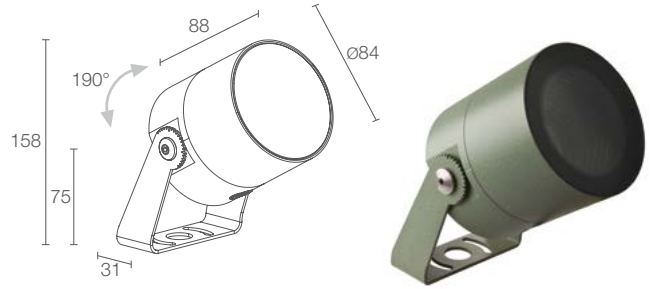

GINKO 3.0

✓
GINKO 3.0
3000K, 15W, sharp 48°, anodized black
with shadow-effect filter



POWER SUPPLY CODE

24Vdc
GN300 ■ ■ ■ ■ ■ I - Stainless steel
GN300 ■ ■ ■ ■ ■ E - White
GN300 ■ ■ ■ ■ ■ N - Anodized black
GN300 ■ ■ ■ ■ ■ F - Grey
GN300 ■ ■ ■ ■ ■ H - Anthracite
GN300 ■ ■ ■ ■ ■ T - Cor-ten
GN300 ■ ■ ■ ■ ■ 5 - Jasper green

POWER	0 - 10W 1 - 15W
CRI	0 - CRI 80 1 - CRI >90
LED COLOUR	F - 2700K 5 - 3000K 9 - 4000K RGBW (10W 24Vdc) on request
OPTICS	S - 13° M - 30° L - 42° P - 48° sharp J - 58° W - 12°x64° adjustable X - 28°x72° adjustable
POWER CABLES	includes 1.5 m neoprene cable H05RN-F 2x0.75/0.75 Ø6.3 mm 1 - 5 m 2 - 10 m 3 - 15 m 4 - 20 m

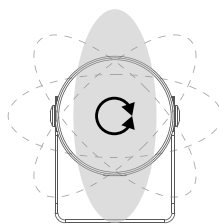

Adjustable elliptical optics and elliptical zoom lens



elliptical optics, adjusted manually with magnet

LUMEN OUTPUT AT SOURCE	1096 lm (3000K, 10W, CRI 80) 1662 lm (3000K, 15W, CRI 80)
DELIVERED LUMEN OUTPUT	750 lm (3000K, 42°, 10W, CRI 80) 1162 lm (3000K, 42°, 15W, CRI 80)
NO. AND TYPE OF LED	1 high power density COB LED 2-step MacAdam, 50000h L95 B10 (Ta 25°C)
MATERIAL	body in AISI 316L stainless steel or anticorrosional aluminium bracket in AISI 316L stainless steel screen in serigraphed and transparent, tempered extra-clear glass
POWER SUPPLY UNIT	not included, see p. 904
MOUNTING	surface mounted (ceiling, wall, ground, spike, strap)
ACCESSORIES	see p. 238 and 239
FEATURES	12°x64° and 28°x72° optics, and shadow-effect filter, adjustable through 360° using magnet included
NOTES	version with bracket in customized length available on request
PHOTOMETRIC DATA	see p. 835

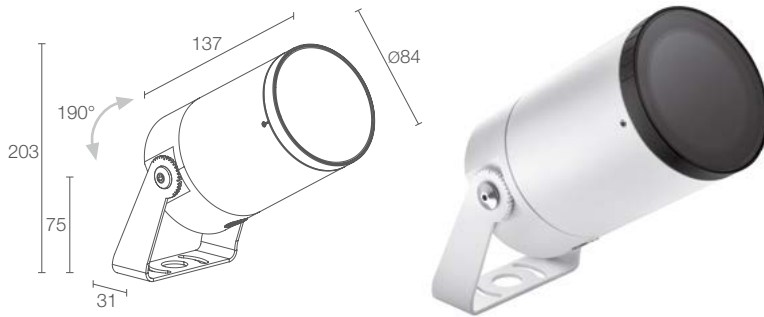

GINKO 3.4



kg 1.53 IP66 IK09



24Vdc

- GN3401** ■ ■ ■ **E** - ■ White
- GN3401** ■ ■ ■ **N** - ■ Anodized black
- GN3401** ■ ■ ■ **F** - ■ Grey
- GN3401** ■ ■ ■ **H** - ■ Anthracite
- GN3401** ■ ■ ■ **T** - ■ Cor-ten
- GN3401** ■ ■ ■ **S** - ■ Jasper green

15W

	0 - CRI 80 1 - CRI >90
	F - 2700K 5 - 3000K 9 - 4000K
	R1 - optical range 8°-38° R2 - optical range 8°x66° - 36°x70° adjustable
	includes 1.5 m neoprene cable H05RN-F 2x0.75/0.75 Ø6.3 mm 1 - 5 m 2 - 10 m 3 - 15 m 4 - 20 m

1662 lm (3000K, CRI 80)

350 lm (3000K, 38°, CRI 80)

1 high power density COB LED
2-step MacAdam, 50000h L95 B10 (Ta 25°C)

body in anticorrosive aluminium
bracket in AISI 316L stainless steel
screen in serigraphed and transparent,
tempered extra-clear glass

not included, see p. 904

surface mounted (ceiling, wall, ground, spike, strap)

see p. 238 and 239

optical range 8°x66° - 36°x70°
adjustable through 360° using magnet included

see p. 835



patented

elliptical optics
adjusted manually
with magnet



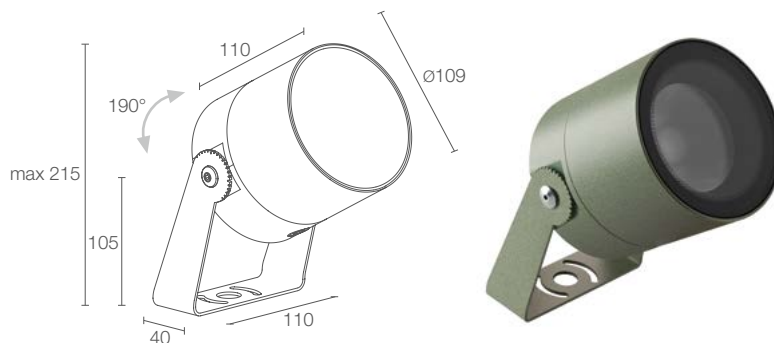

GINKO 4.0

CE ENEC LED TECH III kg 2.10 IP66 IP69K IK08

A A+ A++ IPS CASAMBI

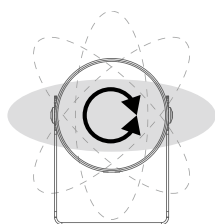

Adjustable elliptical optics



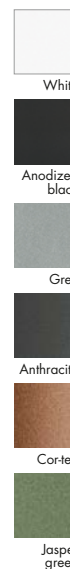

POWER / POWER SUPPLY CODE	25W 24Vdc GN4000 00 0 0 E - White GN4000 00 0 0 N - Anodized black GN4000 00 0 0 F - Grey GN4000 00 0 0 H - Anthracite GN4000 00 0 0 T - Cor-ten GN4000 00 0 0 5 - Jasper green
CRI	0 - CRI 80 1 - CRI >90
HONEYCOMB LOUVRE	0 - not present 1 - present (not compatible with 38° sharp, 13°x65° and 24°x69° optics)
LED COLOUR	F - 2700K 5 - 3000K 9 - 4000K
OPTICS	S - 12° M - 26° L - 34° P - 38° sharp J - 55° W - 13°x65° adjustable X - 24°x69° adjustable
POWER CABLES	includes 1.5 m neoprene cable H05RN-F 2x0.75/0.75 Ø6.3 mm 1 - 5 m 2 - 10 m 3 - 15 m 4 - 20 m

LUMEN OUTPUT AT SOURCE	2302 lm (3000K, CRI 80)
DELIVERED LUMEN OUTPUT	2133 lm (3000K, 12°, CRI 80)
NO. AND TYPE OF LED	1 high power density COB LED, 2-step MacAdam 50000h L95 B10 (Ta 25°C)
MATERIAL	body in anticorrosion aluminium bracket in AISI 316L stainless steel screen in grey-serigraphed and transparent, tempered extra-clear glass
POWER SUPPLY UNIT	not included, see p. 904
MOUNTING	surface mounted (ceiling, wall, ground, spike)
ACCESSORIES	see p. 238 and 239
FEATURES	13°x65° and 24°x69° optics adjustable through 360° using magnet provided
NOTES	version with bracket in customized height available on request
PHOTOMETRIC DATA	see p. 836



elliptical optics adjusted manually with magnet

< **GINKO 3.0**
 4000K, 15W, 13°, with honeycomb louvre
 Project by / CRA-Carlo Ratti Associati and Italo Rota Building Office, with Matteo Gatto and F&M Ingegneria
 Light planning by / Luminæ Lighting Design (Lorenzo Buscaglioni, Paolo Volorio)
 Photo by / Catalin Marin Photography
 Italian Pavilion - EXPO 2020, Dubai, UAE

	GINKO 1.0	GINKO 2.0	GINKO 2.2	GINKO 3.0	GINKO 4.0
<p>ANTI-GLARE ACCESSORIES</p>  <p>Honeycomb louvre built into the lighting fixture order together with the lighting fixture the honeycomb louvre can be fitted on all optics except for sharp optics and adjustable elliptical optics</p>  <p>Standard snoot</p>  <p>Asymmetrical snoot</p>	<p>WH8001</p> <p>WB8011E White</p> <p>WB8011N Anodized black</p> <p>WB8011F Grey</p> <p>WB8011H Anthracite</p> <p>WB8011T Cor-ten</p> <p>WB8011S Jasper green Ø39.5x40 mm</p> <p>WB8021E White</p> <p>WB8021N Anodized black</p> <p>WB8021F Grey</p> <p>WB8021H Anthracite</p> <p>WB8021T Cor-ten</p> <p>WB8021S Jasper green Ø39.5x51 mm</p>	<p>WH0201</p> <p>WB8012E White</p> <p>WB8012N Anodized black</p> <p>WB8012F Grey</p> <p>WB8012H Anthracite</p> <p>WB8012T Cor-ten</p> <p>WB8012S Jasper green Ø59.5x63 mm</p> <p>WB8022E White</p> <p>WB8022N Anodized black</p> <p>WB8022F Grey</p> <p>WB8022H Anthracite</p> <p>WB8022T Cor-ten</p> <p>WB8022S Jasper green Ø59.5x82 mm</p>	<p>WH0201</p> <p>WB8012E White</p> <p>WB8012N Anodized black</p> <p>WB8012F Grey</p> <p>WB8012H Anthracite</p> <p>WB8012T Cor-ten</p> <p>WB8012S Jasper green Ø59.5x63 mm</p> <p>WB8022E White</p> <p>WB8022N Anodized black</p> <p>WB8022F Grey</p> <p>WB8022H Anthracite</p> <p>WB8022T Cor-ten</p> <p>WB8022S Jasper green Ø59.5x82 mm</p>	<p>WH8000</p> <p>WB8010E White</p> <p>WB8010N Anodized black</p> <p>WB8010F Grey</p> <p>WB8010H Anthracite</p> <p>WB8010T Cor-ten</p> <p>WB8010S Jasper green Ø90x85 mm</p> <p>WB8020E White</p> <p>WB8020F Grey</p> <p>WB8020H Anthracite</p> <p>WB8020T Cor-ten</p> <p>WB8020S Jasper green Ø85x92 mm</p>	<p>WB1101E White</p> <p>WB1101N Black</p> <p>WB1101F Grey</p> <p>WB1101H Anthracite</p> <p>WB1101T Cor-ten</p> <p>WB1101S Jasper green Ø115x85 mm</p> <p>WB1102E White</p> <p>WB1102N Black</p> <p>WB1102F Grey</p> <p>WB1102H Anthracite</p> <p>WB1102T Cor-ten</p> <p>WB1102S Jasper green Ø110x120 mm</p>
<p>OPTICAL ACCESSORIES</p>  <p>Shadow-effect filter built into the lighting fixture order together with the lighting fixture the shadow-effect filter can be fitted only on the sharp 48° optics</p>				<p>WR8000</p>	



ACCESSORIES

ACCESSORIES FOR INSTALLATION



WP0100

Spike for in-ground installation
(Ginko 1 / 2 / 3)

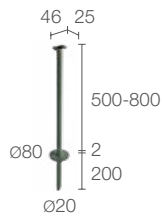

h 500 mm

- WP1006I** - Stainless steel
- WP1006E** - White
- WP1006F** - Grey
- WP1006H** - Anthracite
- WP1006T** - Cor-ten
- WP1006S** - Jasper green

h 800 mm

- WP1007I** - Stainless steel
- WP1007E** - White
- WP1007F** - Grey
- WP1007H** - Anthracite
- WP1007T** - Cor-ten
- WP1007S** - Jasper green

Spike for in-ground installation
(Ginko 2 / 3)



WP0300

Spike for in-ground installation
(Ginko 4.0)



WP1004

Fastener strap – 5 m
(Ginko 1 / 2 / 3)



WF3302

Flexible cable-protection tube – 18 cm
(Ginko 1)
order together with the lighting fixture

WF3301

Flexible cable-protection tube – 15 cm
(Ginko 2)
order together with the lighting fixture

for spare parts, see p. 932



240

L&L Luce&Light



OUTDOOR PROJECTORS FOR HIGHLIGHTING ARCHITECTURAL DETAILS

Ø25 mm

Ø40 mm

Ø60 mm

2700K 3000K 4000K



PIVOT MINI 1 p. 245
2.5W/3.5W 24Vdc
fixed focus

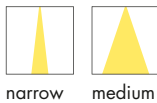

narrow medium



PIVOT 1.7 p. 246
3.5W/5W/7W 24Vdc
fixed focus

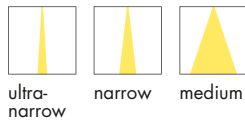

ultra-narrow narrow medium



wide ultra-wide elliptical



PIVOT 2.0 p. 249
10W/14W 24Vdc
fixed focus + zoom lens

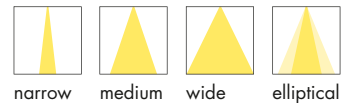

narrow medium wide elliptical



zoom lens



RGB



PIVOT 1.8 p. 247
max 4.5W max 500mA
fixed focus



medium wide ultra-wide elliptical

< **PIVOT 1.7**
3000K, 5W, 11°, anodized grey
Light planning by / Cristian Turra
Photo by / Alessio Tamborini
Private residence, Brescia, Italy

5°

8°

11°

17°

21° sharp

34°

43°

45°

51° sharp

54°

15°x47°

46°x16°



IP66
SUITABLE FOR OUTDOOR APPLICATIONS



BUILT-IN PROTECTION SYSTEMS:
IPS
INTELLIGENT PROTECTION SYSTEM
(PIVOT MINI 1 / PIVOT 1.7 / PIVOT 2.0)



PID
PROTECTIVE IMPEDANCE DEVICE
(PIVOT MINI 1 / PIVOT 1.7)



CRI 80 AND CRI >90 VERSIONS
FOR IMPROVED COLOUR RENDERING



6-STEP MATERIAL PROTECTION, OXIDATION AND CORROSION RESISTANCE
Low-copper-content anticorrosive aluminium alloy 6082
Preparation for painting
Epoxy paint
Polyester paint
Paints compliant with Qualicoat automotive coating standard
Salt spray tested (over 1000 hours)



IK06 (PIVOT MINI)



IK07 (PIVOT 1)



IK08 (PIVOT 2)

SCREEN IN TRANSPARENT EXTRA-CLEAR GLASS,
UP TO 5 MM THICK AND TEMPERED FOR EXCELLENT
RESISTANCE TO KNOCKS AND SCRATCHES.
HIGH-TRANSMITTANCE VITRIFIED SERIGRAPHY
ENSURES CHROMATIC UNIFORMITY

BODY IN ANTICORRODAL 6082
LOW-COPPER-CONTENT ALUMINIUM
ALLOY FOR EXCELLENT RESISTANCE
TO CORROSION, MADE ENTIRELY
ON A CNC LATHE

<

WIDE RANGE OF OPTICS, INCLUDING
5° AND 8° OPTICS, ELLIPTICAL OPTICS,
AND SHARP OPTICS, WHICH CREATE
LIGHT BEAMS WITH PIN-SHARP EDGES



UNIQUE SELLING POINTS



JASPER GREEN FINISH DEVELOPED SPECIFICALLY FOR USE IN LANDSCAPE DESIGN (PIVOT 1.7 / PIVOT 1.8)



WHITE



ANODIZED BLACK



ANODIZED GREY



ANTHRACITE



COR-TEN



COPPER



ANTI-GLARE RECESSED OPTICS



RAL FINISH ON REQUEST



PIVOT 2.0 HAS 13°X68° ELLIPTICAL OPTICS AND MANUAL ZOOM LENS, BOTH ADJUSTABLE USING A MAGNET





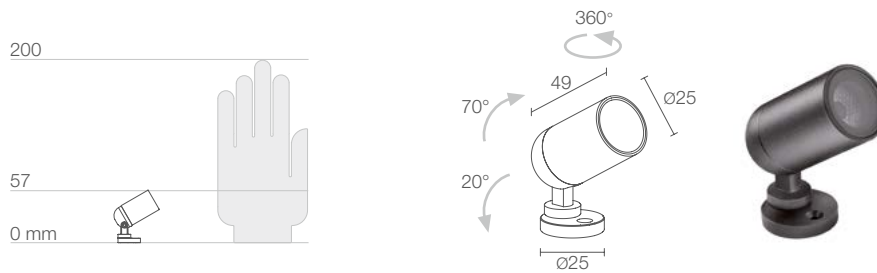

PIVOT MINI 1



POWER SUPPLY CODE

24Vdc
CP010 ■ ■ ■ ■ **E** - ■ White
CP010 ■ ■ ■ ■ **H** - ■ Anthracite
CP010 ■ ■ ■ ■ **T** - ■ Cor-ten
CP010 ■ ■ ■ ■ **U** - ■ Copper

POWER	0 - 2.5W 1 - 3.5W
CRI	0 - CRI 80 1 - CRI >90
HONEYCOMB LOUVRE	0 - not present 1 - present (not compatible with the sharp 30° optics)
LED COLOUR	F - 2700K 5 - 3000K 9 - 4000K
OPTICS	S - 15° M - 21° P - 30° sharp L - 35°
POWER CABLES	includes 1.5 m neoprene cable H05RNF 2x0.35/0.75 Ø6.3 mm 1 - 5 m 2 - 10 m 3 - 15 m 4 - 20 m

LUMEN OUTPUT AT SOURCE	195 lm (3000K, 2.5W, CRI 80) 260 lm (3000K, 3.5W, CRI 80)
DELIVERED LUMEN OUTPUT	118 lm (3000K, 15°, 2.5W, CRI 80) 158 lm (3000K, 15°, 3.5W, CRI 80)
NO. AND TYPE OF LED	1 power LED, 2-step MacAdam 60000h L90 B10 (Ta 25°C)
MATERIAL	body in anticorrosive aluminium screen in serigraphed and transparent, tempered extra-clear glass
POWER SUPPLY UNIT	not included, see p. 904
MOUNTING	surface mounted (ceiling, wall, ground)
ACCESSORIES	see p. 251
PHOTOMETRIC DATA	see p. 860



- < **PIVOT 1.7**
3000K, 7W, 34°, anodized grey
- BRIGHT 1.0**
3000K, 2W, 21°, with honeycomb louvre
- BRIGHT 3.F**
3000K, 10W, 21°

Project by / arch. Angela Sabatelli
 Light planning by / FOR.EL.
 Photo by / Cosimo Rubino
 Church of Maria Santissima del Rosario
 Fasano, Brindisi, Italy

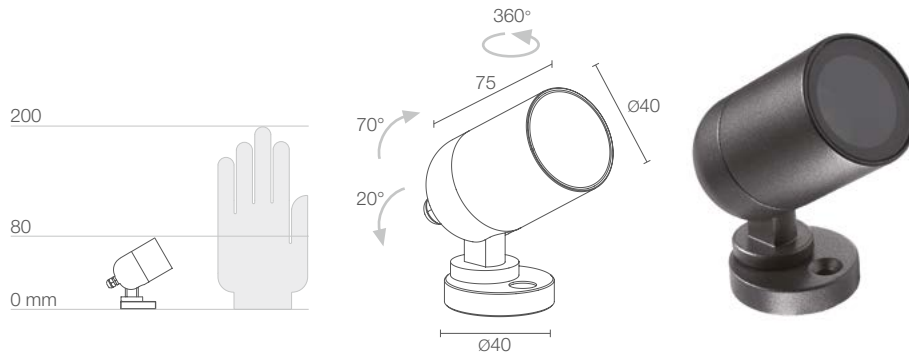

PIVOT 1.7

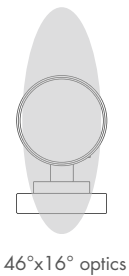
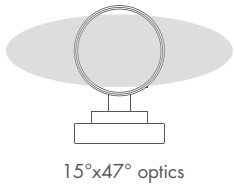

POWER SUPPLY CODE

24Vdc	
CP170	■ ■ ■ ■ ■ ■ E - ■ White
CP170	■ ■ ■ ■ ■ ■ N - ■ Anodized black
CP170	■ ■ ■ ■ ■ ■ A - ■ Anodized grey
CP170	■ ■ ■ ■ ■ ■ H - ■ Anthracite
CP170	■ ■ ■ ■ ■ ■ T - ■ Cor-ten
CP170	■ ■ ■ ■ ■ ■ S - ■ Jasper green
CP170	■ ■ ■ ■ ■ ■ U - ■ Copper

POWER	0 - 3.5W only 5° optics (4000K only CRI 80) 1 - 5W 2 - 7W
CRI	0 - CRI 80 1 - CRI >90
LED COLOUR	F - 2700K 5 - 3000K 9 - 4000K
OPTICS	U - 5° only 3.5W (4000K only CRI 80) V - 8° T - 11° S - 17° P - 21° sharp M - 34° L - 43° J - 45° Q - 51° sharp K - 54° W - 15°x47° X - 46°x16°
POWER CABLES	includes 1.5 m neoprene cable H05RN-F 2x0.35/0.75 Ø6.3 mm 1 - 5 m 2 - 10 m 3 - 15 m 4 - 20 m

LUMEN OUTPUT AT SOURCE	488 lm (3000K, 5W, CRI 80) 657 lm (3000K, 7W, CRI 80)
DELIVERED LUMEN OUTPUT	352 lm (3000K, 34°, 5W, CRI 80) 463 lm (3000K, 34°, 7W, CRI 80)
NO. AND TYPE OF LED	1 high-intensity power LED 3-step MacAdam, 1/4 ANSI BIN (version with 5° optics) 50000h L90 B10 (Ta 25°C)
MATERIAL	body in anticorrosional aluminium screen in serigraphed and transparent, tempered extra-clear glass
POWER SUPPLY UNIT	not included, see p. 904
MOUNTING	surface mounted (ceiling, wall, ground, spike, strap)
ACCESSORIES	see p. 251
PHOTOMETRIC DATA	see p. 860 and 861



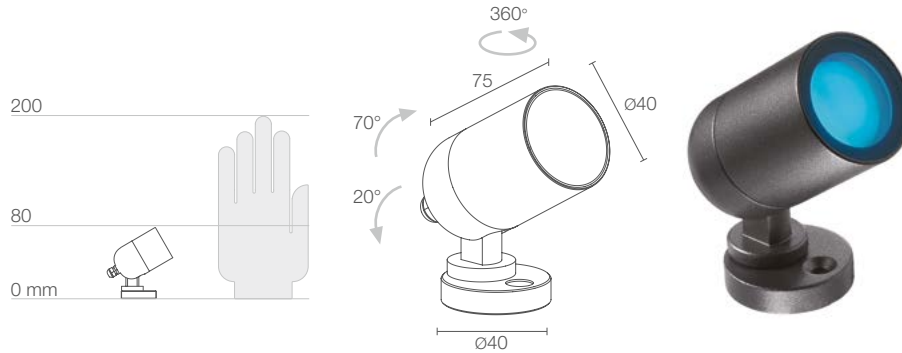

PIVOT 1.8

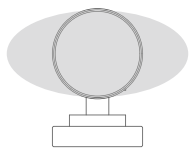

22°x46° optics



46°x22° optics

POWER / POWER SUPPLY CODE

max 4.5W max 500mA
CP1820N00 6 0 E - White
CP1820N00 6 0 N - Anodized black
CP1820N00 6 0 A - Anodized grey
CP1820N00 6 0 H - Anthracite
CP1820N00 6 0 T - Cor-ten
CP1820N00 6 0 S - Jasper green
CP1820N00 6 0 U - Copper

HONEYCOMB LOUVRE	0 - not present 1 - present
OPTICS	S - 20° M - 33° L - 45° K - 58° W - 22°x46° X - 46°x22°
POWER CABLES	includes 1.5 m PVC cable FROR 6x0.25 Ø5.0 mm 1 - 5 m 2 - 10 m 3 - 15 m 4 - 20 m

LED COLOUR RGB

LUMEN OUTPUT AT SOURCE	201 lm, R: 50 lm G: 111 lm B: 40 lm (500mA)
DELIVERED LUMEN OUTPUT	154 lm, R: 43 lm G: 84 lm B: 27 lm (500mA, 33°)
NO. AND TYPE OF LED	3 power LEDs 50000h L90 B10 (Ta 25°C)
MATERIAL	body in anticorodal aluminium screen in serigraphed and transparent, tempered extra-clear glass
POWER SUPPLY UNIT	not included, see p. 904 and 917
WIRING	series
MOUNTING	surface mounted (ceiling, wall, ground, spike, strap)
ACCESSORIES	see p. 251
PHOTOMETRIC DATA	see p. 861





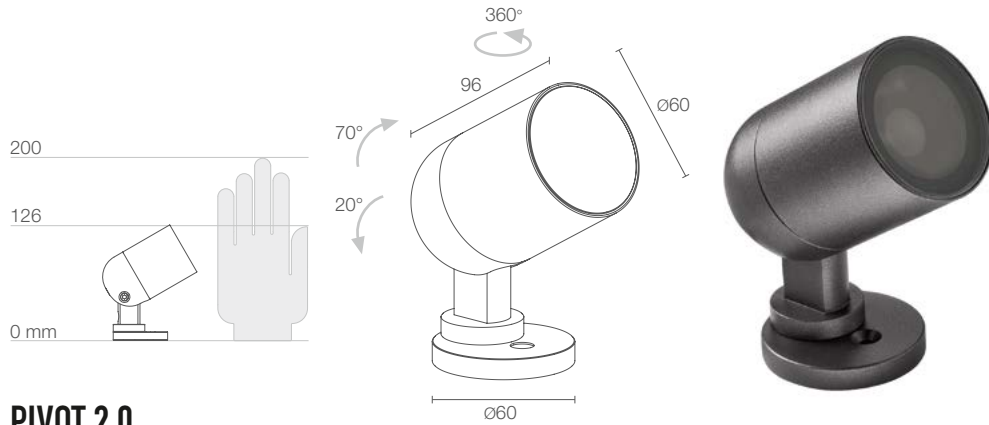

PIVOT 2.0

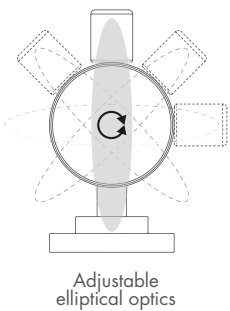

POWER SUPPLY CODE	24Vdc CP200 ■ ■ ■ ■ 00 ■ ■ E - White CP200 ■ ■ ■ ■ 00 ■ ■ H - Anthracite CP200 ■ ■ ■ ■ 00 ■ ■ T - Cor-ten CP200 ■ ■ ■ ■ 00 ■ ■ U - Copper
POWER	0 - 10W 1 - 14W
CRI	0 - CRI 80 1 - CRI >90
HONEYCOMB LOUVRE	0 - not present 1 - present (not compatible with the with sharp 50° and 13°x68° optics, or the 15°-43° zoom lens)
LED COLOUR	F - 2700K 5 - 3000K 9 - 4000K
OPTICS	0S - 13° 0M - 25° 0L - 37° 0Q - 50° sharp 0W - 13°x68° adjustable R3 - zoom lens 15°-43°
POWER CABLES	includes 1.5 m neoprene cable H05RN-F 2x0.35/0.75 Ø6.3 mm 1 - 5 m 2 - 10 m 3 - 15 m 4 - 20 m

LUMEN OUTPUT AT SOURCE	978 lm (3000K, 10W, CRI 80) 1397 lm (3000K, 14W, CRI 80)
DELIVERED LUMEN OUTPUT	835 lm (3000K, 25°, 10W, CRI 80) 1064 lm (3000K, 25°, 14W, CRI 80)
NO. AND TYPE OF LED	1 COB LED, 3-step MacAdam 50000h L95 B10 (Ta 25°C)
MATERIAL	body in anticorodal aluminium screen in serigraphed and transparent, tempered extra-clear glass
POWER SUPPLY UNIT	not included, see p. 904
MOUNTING	surface mounted (ceiling, wall, ground, spike)
ACCESSORIES	see p. 251
FEATURES	manual zoom lens adjustable using magnet included 13°x68° optics adjustable through 360° using magnet included
PHOTOMETRIC DATA	see p. 862







< **PIVOT 1.7**
4000K, 7W, 8°, cor-ten
BRIGHT 2.4
4000K, 5W, 13°x52°, stainless steel

Photo by / Andrea Rinaldi
The sea room of the Museo di Storia Naturale del Mediterraneo, Livorno, Italy





ACCESSORIES

	PIVOT MINI 1	PIVOT 1.7	PIVOT 1.8	PIVOT 2.0
<p>ANTI-GLARE ACCESSORIES</p>  <p>Honeycomb louvre built into the lighting fixture order together with the lighting fixture the honeycomb louvre can be fitted on all optics except for sharp optics</p>  <p>Standard snoot</p>  <p>Asymmetrical snoot</p>	<p>WBA02E White</p> <p>WBA02H Anthracite</p> <p>WBA02T Cor-ten</p> <p>WBA02U Copper</p> <p>Ø29.5x27.5 mm</p> <p>WBA03E White</p> <p>WBA03H Anthracite</p> <p>WBA03T Cor-ten</p> <p>WBA03U Copper</p> <p>Ø29.5x34.67 mm</p>	<p>WH0310</p> <p>WB0310E White</p> <p>WB0310N Anodized black</p> <p>WB0310A Anodized grey</p> <p>WB0310H Anthracite</p> <p>WB0310T Cor-ten</p> <p>WB0310S Jasper green</p> <p>WB0310U Copper</p> <p>Ø44x30 mm</p> <p>WB0311E White</p> <p>WB0311N Anodized black</p> <p>WB0311A Anodized grey</p> <p>WB0311H Anthracite</p> <p>WB0311T Cor-ten</p> <p>WB0311S Jasper green</p> <p>WB0311U Copper</p> <p>Ø44x36 mm</p>	<p>WB0310E White</p> <p>WB0310N Anodized black</p> <p>WB0310A Anodized grey</p> <p>WB0310H Anthracite</p> <p>WB0310T Cor-ten</p> <p>WB0310S Jasper green</p> <p>WB0310U Copper</p> <p>Ø44x30 mm</p> <p>WB0311E White</p> <p>WB0311N Anodized black</p> <p>WB0311A Anodized grey</p> <p>WB0311H Anthracite</p> <p>WB0311T Cor-ten</p> <p>WB0311S Jasper green</p> <p>WB0311U Copper</p> <p>Ø44x36 mm</p>	<p>WB1001E White</p> <p>WB1001H Anthracite</p> <p>WB1001T Cor-ten</p> <p>WB1001U Copper</p> <p>Ø64.5x70 mm</p> <p>WB1002E White</p> <p>WB1002H Anthracite</p> <p>WB1002T Cor-ten</p> <p>WB1002U Copper</p> <p>Ø64.5x90 mm</p>
<p>ACCESSORIES FOR INSTALLATION</p>  <p>Spike for in-ground installation</p>  <p>Fastener strap - 5 m</p>	<p>WP0100</p> <p>WP1004</p>	<p>WP0100</p> <p>WP1004</p>	<p>WP0100</p> <p>WP1004</p>	

for spare parts, see p. 932





OUTDOOR PROJECTORS ARCHITECTURAL LIGHTING FOR ARCADES, NAVES AND CLOISTERS

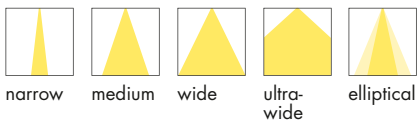

narrow medium wide ultra-wide elliptical



2700K 3000K 4000K



DUOMO 1.0 p. 256
10W 230Vac
ON/OFF



DUOMO 2.0 p. 256
19W 230Vac
ON/OFF



DUOMO 3.0 p. 257
28W 230Vac
ON/OFF, DALI + PUSH



DUOMO 4.0 p. 257
56W 230Vac
ON/OFF, DALI + PUSH



IP54
SUITABLE FOR INSTALLATION
IN CLOISTERS AND COLONNADES



BUILT-IN PROTECTION SYSTEMS:
PID
PROTECTIVE IMPEDANCE DEVICE



BUILT-IN POWER
SUPPLY UNIT



DIMMING WITH DALI.
AVAILABLE ON REQUEST IN 0/1-10V OR PUSH VERSION,
OR WITH BLUETOOTH CONTROL



IK06
SCREEN IN 4-MM-THICK, SERIGRAPHED
AND TRANSPARENT EXTRA-CLEAR GLASS,
TEMPERED FOR EXCELLENT IMPACT
AND SCRATCH RESISTANCE.

BODY AND BRACKET MADE OF
LOW-COPPER-CONTENT ANTICORODAL
ALUMINIUM ALLOY EN AW 6060 T5 FOR
EXCELLENT RESISTANCE TO CORROSION



DUOMO'S ADJUSTABLE BRACKET
MEANS THE FIXTURE CAN BE
CANTILEVERED FROM CORNICES OR
OTHER ARCHITECTURAL ELEMENTS

UNIQUE SELLING POINTS

ANTIQUÉ WHITE FINISH TO VISUALLY INTEGRATE THE LIGHTING FIXTURE INTO HISTORIC BUILDINGS



THE BRACKET CAN SLIDE ALONG THE ENTIRE LENGTH OF THE HEAD, ALLOWING THE PROJECTOR TO BE INSTALLED AND ANGLED IN TIGHT SPACES



ANTI-GLARE
RECESSED OPTICS



FAST INSTALLATION:
DIRECT CONNECTION
BETWEEN FIXTURE AND
MAINS POWER SUPPLY

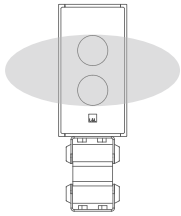

18°x44° optics



44°x18° optics

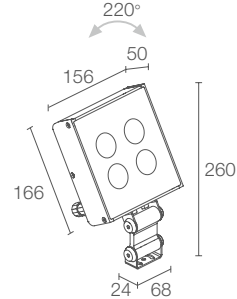
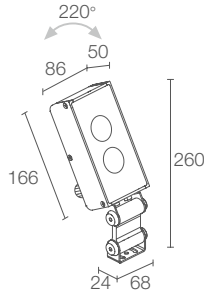

DUOMO 1.0



POWER / POWER SUPPLY CODE

10W 230Vac ON/OFF
DU1010 ■ ■ ■ ■ ■ **0 6** Antique white
DU1010 ■ ■ ■ ■ ■ **0 E** White
DU1010 ■ ■ ■ ■ ■ **0 H** Anthracite

DUOMO 2.0



19W 230Vac ON/OFF
DU2010 ■ ■ ■ ■ ■ **0 6** Antique white
DU2010 ■ ■ ■ ■ ■ **0 E** White
DU2010 ■ ■ ■ ■ ■ **0 H** Anthracite

■ CRI	0 - CRI 80 1 - CRI >90								
■ HONEYCOMB LOUVRE	0 - not present 1 - present (not compatible with the 10° optics)								
■ LED COLOUR	F - 2700K 5 - 3000K 9 - 4000K								
■ OPTICS	<table border="0"> <tr> <td>T - 10°</td> <td>J - 43°</td> </tr> <tr> <td>S - 14°</td> <td>K - 63°</td> </tr> <tr> <td>M - 30°</td> <td>W - 18°x44°</td> </tr> <tr> <td>L - 35°</td> <td>X - 44°x18°</td> </tr> </table>	T - 10°	J - 43°	S - 14°	K - 63°	M - 30°	W - 18°x44°	L - 35°	X - 44°x18°
T - 10°	J - 43°								
S - 14°	K - 63°								
M - 30°	W - 18°x44°								
L - 35°	X - 44°x18°								

■	0 - CRI 80 1 - CRI >90								
■	0 - not present 1 - present (not compatible with the 10° optics)								
■	F - 2700K 5 - 3000K 9 - 4000K								
■	<table border="0"> <tr> <td>T - 10°</td> <td>J - 43°</td> </tr> <tr> <td>S - 14°</td> <td>K - 63°</td> </tr> <tr> <td>M - 30°</td> <td>W - 18°x44°</td> </tr> <tr> <td>L - 35°</td> <td>X - 44°x18°</td> </tr> </table>	T - 10°	J - 43°	S - 14°	K - 63°	M - 30°	W - 18°x44°	L - 35°	X - 44°x18°
T - 10°	J - 43°								
S - 14°	K - 63°								
M - 30°	W - 18°x44°								
L - 35°	X - 44°x18°								

LUMEN OUTPUT AT SOURCE	880 lm (3000K, CRI 80)
DELIVERED LUMEN OUTPUT	714 lm (3000K, 30°, CRI 80)
NO. AND TYPE OF LED	2 high-intensity power LEDs 3-step MacAdam, 50000h L90 B10 (Ta 25°C)
MATERIAL	body and bracket in Anticorodal aluminium screen in serigraphed, tempered, extra-clear glass
POWER SUPPLY UNIT	built in
MOUNTING	surface mounted (ceiling, wall, floor)
ACCESSORIES	see p. 259
FEATURES	fast installation: direct connection between fixture and mains power supply
NOTES	available on request with adapter for Eurostandard track and in DALI, 0/1-10V or PUSH version, or with Bluetooth control Casambi-compatible version, controllable with the Casambi app, available on request
PHOTOMETRIC DATA	see p. 821

LUMEN OUTPUT AT SOURCE	1760 lm (3000K, CRI 80)
DELIVERED LUMEN OUTPUT	1428 lm (3000K, 30°, CRI 80)
NO. AND TYPE OF LED	4 high-intensity power LEDs 3-step MacAdam, 50000h L90 B10 (Ta 25°C)
MATERIAL	body and bracket in Anticorodal aluminium screen in serigraphed, tempered, extra-clear glass
POWER SUPPLY UNIT	built in
MOUNTING	surface mounted (ceiling, wall, floor)
ACCESSORIES	see p. 259
FEATURES	fast installation: direct connection between fixture and mains power supply
NOTES	available on request with adapter for Eurostandard track and in DALI, 0/1-10V or PUSH version, or with Bluetooth control Casambi-compatible version, controllable with the Casambi app, available on request
PHOTOMETRIC DATA	see p. 821 and 822

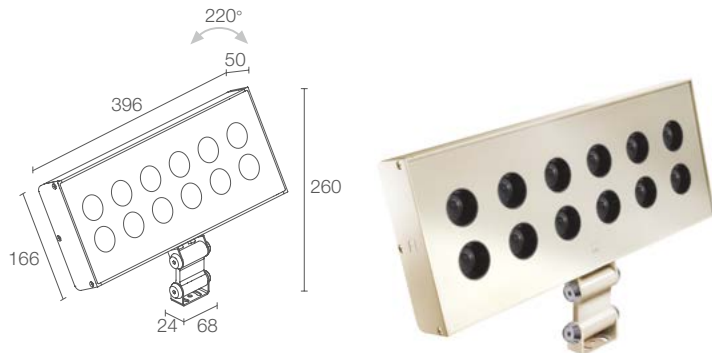
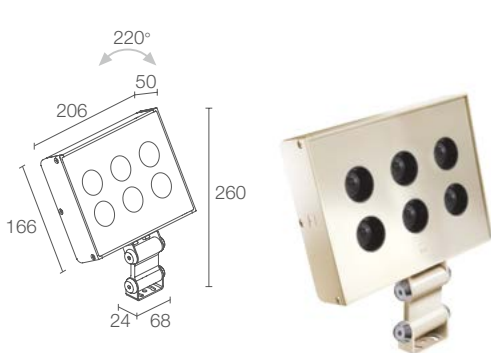

DUOMO 3.0

CE ENEC LED TECH IP54 IK06
 A A+ A++ PID DALI PUSH

28W 230Vac ON/OFF
DU3010 00 0 6 Antique white
DU3010 00 0 E White
DU3010 00 0 H Anthracite

28W 230Vac DALI + PUSH
DU3010 D0 0 6 Antique white
DU3010 D0 0 E White
DU3010 D0 0 H Anthracite

0 - CRI 80 1 - CRI >90	
0 - not present 1 - present (not compatible with the 10° optics)	
F - 2700K 5 - 3000K 9 - 4000K	
T - 10° S - 14° M - 30° L - 35°	J - 43° K - 63° W - 18°x44° X - 44°x18°

2640 lm (3000K, CRI 80)
2142 lm (3000K, 30°, CRI 80)
6 high-intensity power LEDs 3-step MacAdam, 50000h L90 B10 (Ta 25°C)
body and bracket in Anticorodal aluminium screen in serigraphed, tempered, extra-clear glass
built in
surface mounted (ceiling, wall, floor)
see p. 259
fast installation: direct connection between fixture and mains power supply
available on request with adapter for Eurostandard track and in 0/1-10V or PUSH version, or with Bluetooth control Casambi-compatible version, controllable with the Casambi app, available on request
see p. 822

DUOMO 4.0

CE ENEC LED TECH IP54 IK06
 A A+ A++ PID DALI PUSH

56W 230Vac ON/OFF
DU4010 00 0 6 Antique white
DU4010 00 0 E White
DU4010 00 0 H Anthracite

56W 230Vac DALI + PUSH
DU4010 D0 0 6 Antique white
DU4010 D0 0 E White
DU4010 D0 0 H Anthracite

0 - CRI 80 1 - CRI >90	
0 - not present 1 - present (not compatible with the 10° optics)	
F - 2700K 5 - 3000K 9 - 4000K	
T - 10° S - 14° M - 30° L - 35°	J - 43° K - 63° W - 18°x44° X - 44°x18°

5280 lm (3000K, CRI 80)
4284 lm (3000K, 30°, CRI 80)
12 high-intensity power LED 3-step MacAdam, 50000h L90 B10 (Ta 25°C)
body and bracket in Anticorodal aluminium screen in serigraphed, tempered, extra-clear glass
built in
surface mounted (ceiling, wall, floor)
see p. 259
fast installation: direct connection between fixture and mains power supply
available on request with adapter for Eurostandard track and in 0/1-10V or PUSH version, or with Bluetooth control Casambi-compatible version, controllable with the Casambi app, available on request
see p. 823







ACCESSORIES

ACCESSORIES



WFA00

2-pin male connector
for in/out connection - IP68
(on/off version)
(Duomo 2.0 / 3.0 / 4.0)

WFA01

4-pin male connector
for in/out connection
(DALI version)
(Duomo 3.0 / 4.0)



WMA006 - Antique white

WMA00E - White

WMA00H - Anthracite

Adjustable bracket





OUTDOOR PROJECTORS ARCHITECTURAL LIGHTING FOR FACADES

2700K 3000K 4000K

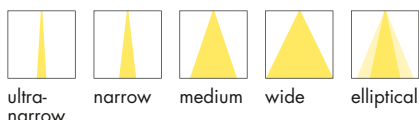

SIRI 1.0 p. 264
9W 230Vac
ON/OFF



SIRI 2.0 p. 266
16W 230Vac
ON/OFF



SIRI 3.0 p. 268
23W 230Vac
ON/OFF, 0/1-10V



SIRI 1.1 p. 264
9W 230Vac
ON/OFF



SIRI 2.1 p. 266
16W 230Vac
ON/OFF



SIRI 3.1 p. 268
23W 230Vac
ON/OFF, 0/1-10V

RGBW

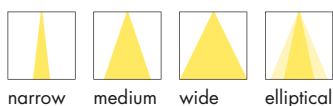

SIRI 1.2 p. 265
11W 24Vdc



SIRI 2.2 p. 267
20W 24Vdc



SIRI 3.2 p. 269
33W 24Vdc



SIRI 1.3 p. 265
11W 24Vdc



SIRI 2.3 p. 267
20W 24Vdc



SIRI 3.3 p. 269
33W 24Vdc

< **SIRI 2.0**
16W, 4000K, 30°, cor-ten
16W, 4000K, 40°, cor-ten
Carballeira de Moraña
Moraña, Pontevedra, Spain

RGBW
VERSION



IP66
SUITABLE FOR OUTDOOR
APPLICATIONS



BUILT-IN PROTECTION SYSTEMS:
IPS
INTELLIGENT PROTECTION SYSTEM



PID
PROTECTIVE IMPEDANCE DEVICE
(WHITE LED COLOUR)



NTC
BUILT-IN TEMPERATURE SENSOR
(SIRI 3.0 / 3.1)



6-STEP MATERIAL PROTECTION,
AND OXIDATION AND
CORROSION RESISTANCE

Low-copper-content aluminium alloy EN AB 47100

Preparation for painting

Epoxy paint

Polyester paint

Paints compliant with

Qualicoat automotive coating standard

Salt spray tested (over 1000 hours)



IK06 (SIRI 2/3)

IK07 (SIRI 1)

SCREEN IN 4-MM-THICK, TRANSPARENT
EXTRA-CLEAR GLASS, TEMPERED

FOR EXCELLENT RESISTANCE

TO KNOCKS AND SCRATCHES.

HIGH-TRANSMITTANCE VITRIFIED SERIGRAPHY

ENSURES CHROMATIC UNIFORMITY

BODY IN DIE-CAST LOW-COPPER-CONTENT

ALUMINIUM EN AB 47100

FOR EXCELLENT RESISTANCE

TO CORROSION



UNIQUE SELLING POINTS



RAL FINISH
ON REQUEST



WHITE



GREY



ANTHRACITE



THE 6° OPTICS MEAN THE BEAM CAN BE CONCENTRATED ON A SMALL AREA EVEN AT LARGE DISTANCES

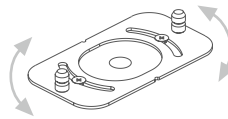

INTEGRATED BASE FOR CONNECTIONS, AND PLATE ADJUSTABLE THROUGH 35°



ANTI-GLARE RECESSED OPTICS



SCALED, ADJUSTABLE BRACKET

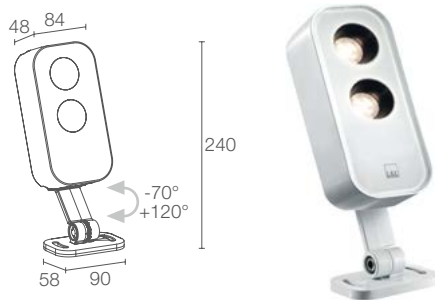
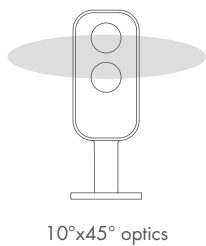

SIRI 1.0



IP66 IK07



POWER / POWER SUPPLY CODE

9W 230Vac
SR1010 ■ ■ **E** - ■ White
SR1010 ■ ■ **F** - ■ Grey
SR1010 ■ ■ **H** - ■ Anthracite
SR1010 ■ ■ **T** - ■ Cor-ten

■	LED COLOUR	F - 2700K 5 - 3000K 9 - 4000K
■	OPTICS	V - 6° S - 12° M - 30° L - 40° W - 10°x45°
■	POWER CABLES	includes 1.5 m neoprene cable H05RN-F 3x1.00 Ø7.0 mm 1 - 5 m 2 - 10 m 3 - 15 m 4 - 20 m

LUMEN OUTPUT AT SOURCE	603 lm (3000K)
DELIVERED LUMEN OUTPUT	422 lm (3000K, 30°)
NO. AND TYPE OF LED	2 power LEDs 1/4 ANSI BIN, 50000h L95 B10 (Ta 25°C)
MATERIAL	body in die-cast aluminium screen in serigraphed and transparent, tempered extra-clear glass
POWER SUPPLY UNIT	built in
MOUNTING	surface mounted (ceiling, wall, ground, spike)
ACCESSORIES	see p. 271
NOTES	Casambi-compatible version, controllable with the Casambi app, available on request
PHOTOMETRIC DATA	see p. 874

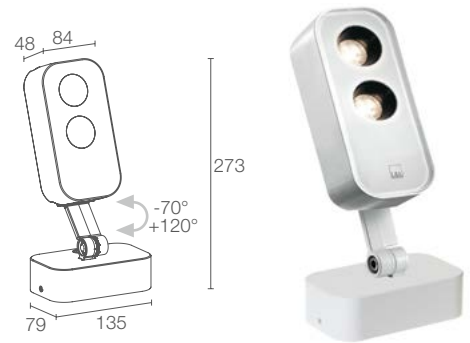

SIRI 1.1



IP66 IK07



9W 230Vac
SR1110 ■ ■ **E** White
SR1110 ■ ■ **F** Grey
SR1110 ■ ■ **H** Anthracite
SR1110 ■ ■ **T** Cor-ten

■	LED COLOUR	F - 2700K 5 - 3000K 9 - 4000K
■	OPTICS	V - 6° S - 12° M - 30° L - 40° W - 10°x45°
		includes 1.5 m neoprene cable H05RN-F 3x1.00 Ø7.0 mm

LUMEN OUTPUT AT SOURCE	603 lm (3000K)
DELIVERED LUMEN OUTPUT	422 lm (3000K, 30°)
NO. AND TYPE OF LED	2 power LEDs 1/4 ANSI BIN, 50000h L95 B10 (Ta 25°C)
MATERIAL	body in die-cast aluminium screen in serigraphed and transparent, tempered extra-clear glass
POWER SUPPLY UNIT	built in
MOUNTING	surface mounted (ceiling, wall, ground)
ACCESSORIES	see p. 271
NOTES	Casambi-compatible version, controllable with the Casambi app, available on request
PHOTOMETRIC DATA	see p. 874

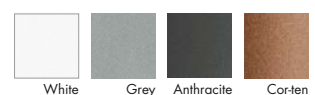

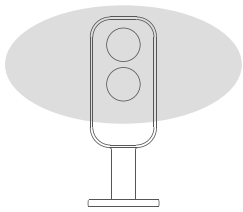

30°x60° optics

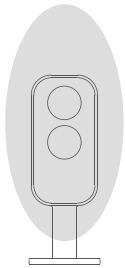

60°x30° optics

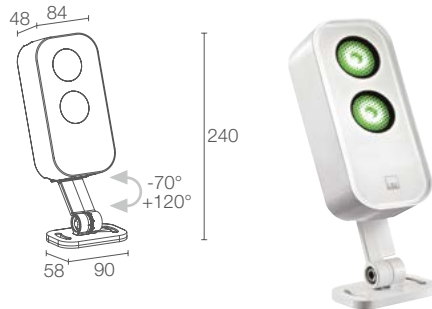

SIRI 1.2



IP66 IK07



POWER / POWER SUPPLY CODE

11W 24Vdc
SR1200 7 E White
SR1200 7 F Grey
SR1200 7 H Anthracite
SR1200 7 T Cor-ten

OPTICS

S - 21°
M - 32°
L - 58°
W - 30°x60°
X - 60°x30°

LED COLOUR

RGBW

LUMEN OUTPUT AT SOURCE 536 lm, R: 83 lm G: 150 lm B: 60 lm
 W: 243 lm (4000K)

DELIVERED LUMEN OUTPUT 379 lm, R: 59 lm G: 105 lm B: 42 lm
 W: 173 lm (4000K, 32°)

NO. AND TYPE OF LED 2 RGBW LED groups
 50000h L90 B10 (Ta 25°C)

MATERIAL body in die-cast aluminium
 screen in serigraphed and transparent, tempered extra-clear glass

POWER SUPPLY UNIT not included, see p. 904 and 917

POWER CABLES includes 1.5 m FEP+RUB cable
 (equivalent to H05RN-F) 6x0.50/0.50 Ø6.3 mm

MOUNTING surface mounted (ceiling, wall, ground, spike)

ACCESSORIES see p. 271

PHOTOMETRIC DATA see p. 874

SIRI 1.3



IP66 IK07



11W 24Vdc
SR1300 7 E White
SR1300 7 F Grey
SR1300 7 H Anthracite
SR1300 7 T Cor-ten

S - 21°
M - 32°
L - 58°
W - 30°x60°
X - 60°x30°

LED COLOUR

RGBW

LUMEN OUTPUT AT SOURCE 536 lm, R: 83 lm G: 150 lm B: 60 lm
 W: 243 lm (4000K)

DELIVERED LUMEN OUTPUT 379 lm, R: 59 lm G: 105 lm B: 42 lm
 W: 173 lm (4000K, 32°)

NO. AND TYPE OF LED 2 RGBW LED groups
 50000h L90 B10 (Ta 25°C)

MATERIAL body in die-cast aluminium
 screen in serigraphed and transparent, tempered extra-clear glass

POWER SUPPLY UNIT not included, see p. 904 and 917

POWER CABLES includes 1.5 m FEP+RUB cable
 (equivalent to H05RN-F) 6x0.50/0.50 Ø6.3 mm

MOUNTING surface mounted (ceiling, wall, ground)

ACCESSORIES see p. 271

PHOTOMETRIC DATA see p. 874

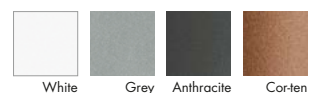

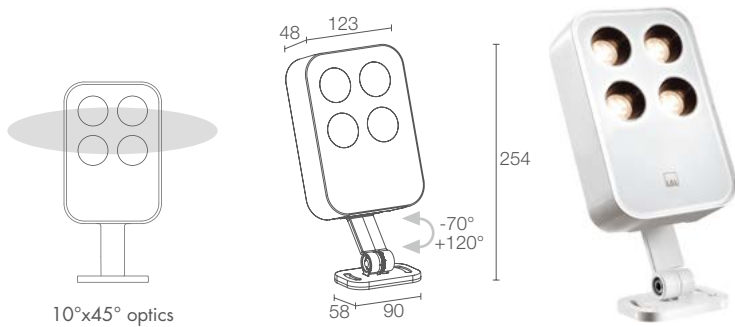

SIRI 2.0

CE EAC LED TECH kg 1.41

IP66 IK06

A A+ A++ IPS PID

POWER / POWER SUPPLY CODE

16W 230Vac
SR2010 E - White
SR2010 F - Grey
SR2010 H - Anthracite
SR2010 T - Cor-ten

LED COLOUR	F - 2700K 5 - 3000K 9 - 4000K
OPTICS	V - 6° S - 12° M - 30° L - 40° W - 10°x45°
POWER CABLES	includes 1.5 m neoprene cable H05RN-F 3x1.00 Ø7.0 mm 1 - 5 m 2 - 10 m 3 - 15 m 4 - 20 m

LUMEN OUTPUT AT SOURCE	1311 lm (3000K)
DELIVERED LUMEN OUTPUT	925 lm (3000K, 30°)
NO. AND TYPE OF LED	4 power LEDs 1/4 ANSI BIN, 50000h L95 B10 (Ta 25°C)
MATERIAL	body in die-cast aluminium screen in serigraphed and transparent, tempered extra-clear glass
POWER SUPPLY UNIT	built in
MOUNTING	surface mounted (ceiling, wall, ground, spike)
ACCESSORIES	see p. 271
NOTES	Casambi-compatible version, controllable with the Casambi app, available on request
PHOTOMETRIC DATA	see p. 875



SIRI 2.1

CE EAC LED TECH kg 1.95

IP66 IK06

A A+ A++ IPS PID

16W 230Vac
SR2110 E - White
SR2110 F - Grey
SR2110 H - Anthracite
SR2110 T - Cor-ten

LED COLOUR	F - 2700K 5 - 3000K 9 - 4000K
OPTICS	V - 6° S - 12° M - 30° L - 40° W - 10°x45°
POWER CABLES	includes 1.5 m neoprene cable H05RN-F 3x1.00 Ø7.0 mm

LUMEN OUTPUT AT SOURCE	1311 lm (3000K)
DELIVERED LUMEN OUTPUT	925 lm (3000K, 30°)
NO. AND TYPE OF LED	4 power LEDs 1/4 ANSI BIN, 50000h L95 B10 (Ta 25°C)
MATERIAL	body in die-cast aluminium screen in serigraphed and transparent, tempered extra-clear glass
POWER SUPPLY UNIT	built in
MOUNTING	surface mounted (ceiling, wall, ground)
ACCESSORIES	see p. 271
NOTES	Casambi-compatible version, controllable with the Casambi app, available on request
PHOTOMETRIC DATA	see p. 875

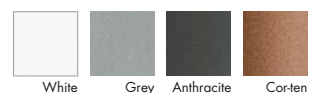

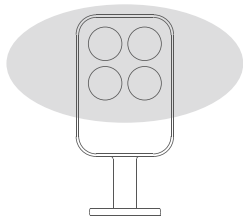

30°x60° optics

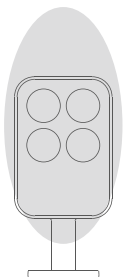

60°x30° optics

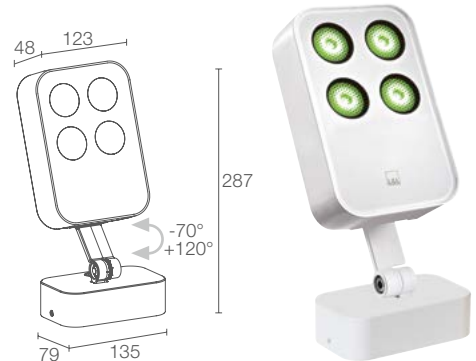
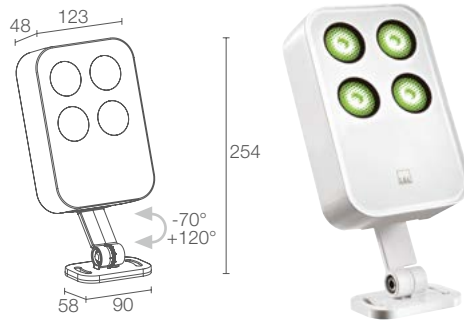

SIRI 2.2



IP66 IK06



POWER / POWER SUPPLY CODE

20W 24Vdc
SR2200 7 E White
SR2200 7 F Grey
SR2200 7 H Anthracite
SR2200 7 T Cor-ten

OPTICS

S - 21°
M - 32°
L - 58°
W - 30°x60°
X - 60°x30°

LED COLOUR

RGBW

LUMEN OUTPUT AT SOURCE	1059 lm, R: 165 lm G: 293 lm B: 118 lm W: 483 lm (4000K)
DELIVERED LUMEN OUTPUT	756 lm, R: 118 lm G: 209 lm B: 84 lm W: 345 lm (4000K, 32°)
NO. AND TYPE OF LED	4 RGBW LED groups 50000h L90 B10 (Ta 25°C)
MATERIAL	body in die-cast aluminium screen in serigraphed and transparent, tempered extra-clear glass
POWER SUPPLY UNIT	not included, see p. 904 and 917
POWER CABLES	includes 1.5 m FEP+RUB cable (equivalent to H05RN-F) 6x0.50/0.50 Ø6.3 mm
MOUNTING	surface mounted (ceiling, wall, ground, spike)
ACCESSORIES	see p. 271
PHOTOMETRIC DATA	see p. 875

SIRI 2.3



IP66 IK06



20W 24Vdc
SR2300 7 E White
SR2300 7 F Grey
SR2300 7 H Anthracite
SR2300 7 T Cor-ten

S - 21°
M - 32°
L - 58°
W - 30°x60°
X - 60°x30°

LED COLOUR

RGBW

LUMEN OUTPUT AT SOURCE	1059 lm, R: 165 lm G: 293 lm B: 118 lm W: 483 lm (4000K)
DELIVERED LUMEN OUTPUT	756 lm, R: 118 lm G: 209 lm B: 84 lm W: 345 lm (4000K, 32°)
NO. AND TYPE OF LED	4 RGBW LED groups 50000h L90 B10 (Ta 25°C)
MATERIAL	body in die-cast aluminium screen in serigraphed and transparent, tempered extra-clear glass
POWER SUPPLY UNIT	not included, see p. 904 and 917
POWER CABLES	includes 1.5 m FEP+RUB cable (equivalent to H05RN-F) 6x0.50/0.50 Ø6.3 mm
MOUNTING	surface mounted (ceiling, wall, ground)
ACCESSORIES	see p. 271
PHOTOMETRIC DATA	see p. 875

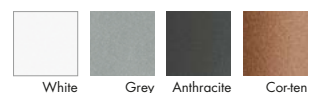

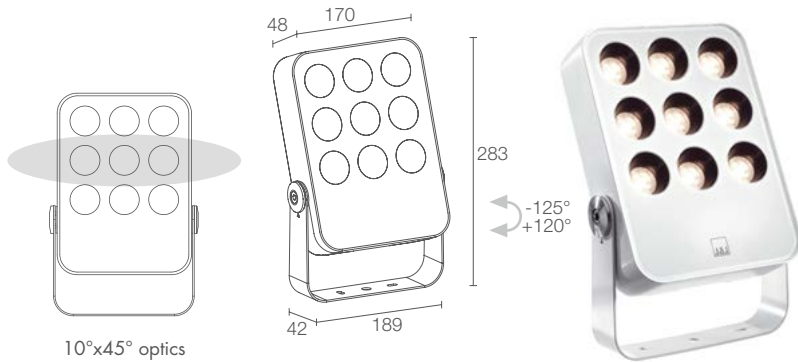

SIRI 3.0

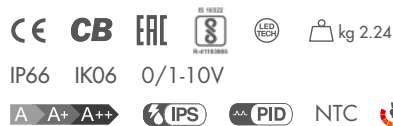

POWER / POWER SUPPLY CODE

23W 230Vac ON/OFF
SR3010 ■ ■ ■ E - ■ ■ White
SR3010 ■ ■ ■ F - ■ ■ Grey
SR3010 ■ ■ ■ H - ■ ■ Anthracite
SR3010 ■ ■ ■ T - ■ ■ Cor-ten

23W 230Vac 0/1-10V
SR3010 ■ ■ ■ ER - ■ ■ White
SR3010 ■ ■ ■ FR - ■ ■ Grey
SR3010 ■ ■ ■ HR - ■ ■ Anthracite
SR3010 ■ ■ ■ TR - ■ ■ Cor-ten

■ LED COLOUR	F - 2700K 5 - 3000K 9 - 4000K
■ OPTICS	V - 6° S - 12° M - 30° L - 40° W - 10°x45°
■ POWER CABLES	includes 1.5 m neoprene cable H05RN-F 3x1.00 Ø7.0 mm 1 - 5 m 2 - 10 m 3 - 15 m 4 - 20 m

LUMEN OUTPUT AT SOURCE	2214 lm (3000K)
DELIVERED LUMEN OUTPUT	1491 lm (3000K, 30°)
NO. AND TYPE OF LED	9 power LEDs 1/4 ANSI BIN, 50000h L95 B10 (Ta 25°C)
MATERIAL	body in die-cast aluminium screen in serigraphed and transparent, tempered extra-clear glass
POWER SUPPLY UNIT	built in
MOUNTING	surface mounted (ceiling, wall, ground, spike)
ACCESSORIES	see p. 271
NOTES	Casambi-compatible version, controllable with the Casambi app, available on request
PHOTOMETRIC DATA	see p. 875



SIRI 3.1

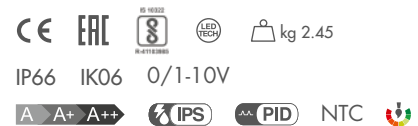

23W 230Vac ON/OFF
SR3110 ■ ■ ■ E White
SR3110 ■ ■ ■ F Grey
SR3110 ■ ■ ■ H Anthracite
SR3110 ■ ■ ■ T Cor-ten

23W 230Vac 0/1-10V
SR3110 ■ ■ ■ ER White
SR3110 ■ ■ ■ FR Grey
SR3110 ■ ■ ■ HR Anthracite
SR3110 ■ ■ ■ TR Cor-ten

■ LED COLOUR	F - 2700K 5 - 3000K 9 - 4000K
■ OPTICS	V - 6° S - 12° M - 30° L - 40° W - 10°x45°
	includes 1.5 m neoprene cable H05RN-F 3x1.00 Ø7.0 mm

LUMEN OUTPUT AT SOURCE	2214 lm (3000K)
DELIVERED LUMEN OUTPUT	1491 lm (3000K, 30°)
NO. AND TYPE OF LED	9 power LEDs 1/4 ANSI BIN, 50000h L95 B10 (Ta 25°C)
MATERIAL	body in die-cast aluminium screen in serigraphed and transparent, tempered extra-clear glass
POWER SUPPLY UNIT	built in
MOUNTING	surface mounted (ceiling, wall, ground)
ACCESSORIES	see p. 271
NOTES	Casambi-compatible version, controllable with the Casambi app, available on request
PHOTOMETRIC DATA	see p. 875

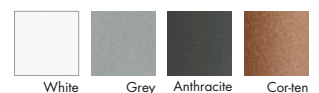

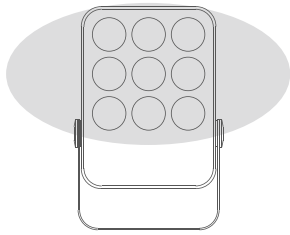

30°x60° optics

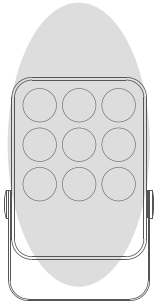

60°x30° optics

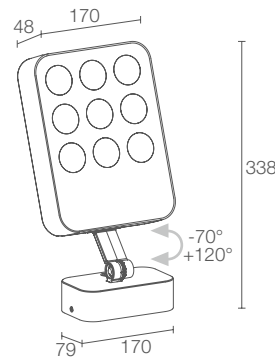

SIRI 3.2

SIRI 3.3



IP66 IK06



IP66 IK06



POWER / POWER SUPPLY CODE

33W 24Vdc
SR3200 7 ■ E White
SR3200 7 ■ F Grey
SR3200 7 ■ H Anthracite
SR3200 7 ■ T Cor-ten

OPTICS

S - 21°
M - 32°
L - 58°
W - 30°x60°
X - 60°x30°

LED COLOUR

RGBW

33W 24Vdc

SR3300 7 ■ E White
SR3300 7 ■ F Grey
SR3300 7 ■ H Anthracite
SR3300 7 ■ T Cor-ten



S - 21°
M - 32°
L - 58°
W - 30°x60°
X - 60°x30°

RGBW

LUMEN OUTPUT AT SOURCE	2148 lm, R: 336 lm G: 594 lm B: 238 lm W: 980 lm (4000K)
DELIVERED LUMEN OUTPUT	1532 lm, R: 240 lm G: 423 lm B: 170 lm W: 699 lm (4000K, 32°)
NO. AND TYPE OF LED	9 RGBW LED groups 50000h L90 B10 (Ta 25°C)
MATERIAL	body in die-cast aluminium screen in serigraphed and transparent, tempered extra-clear glass
POWER SUPPLY UNIT	not included, see p. 904 and 917
POWER CABLES	includes 1.5 m FEP+RUB cable (equivalent to H05RN-F) 6x0.50/0.50 Ø6.3 mm
MOUNTING	surface mounted (ceiling, wall, ground, spike)
ACCESSORIES	see p. 271
PHOTOMETRIC DATA	see p. 875

LUMEN OUTPUT AT SOURCE	2148 lm, R: 336 lm G: 594 lm B: 238 lm W: 980 lm (4000K)
DELIVERED LUMEN OUTPUT	1532 lm, R: 240 lm G: 423 lm B: 170 lm W: 699 lm (4000K, 32°)
NO. AND TYPE OF LED	9 RGBW LED groups 50000h L90 B10 (Ta 25°C)
MATERIAL	body in die-cast aluminium screen in serigraphed and transparent, tempered extra-clear glass
POWER SUPPLY UNIT	not included, see p. 904 and 917
POWER CABLES	includes 1.5 m FEP+RUB cable (equivalent to H05RN-F) 6x0.50/0.50 Ø6.3 mm
MOUNTING	surface mounted (ceiling, wall, ground)
ACCESSORIES	none
PHOTOMETRIC DATA	see p. 875

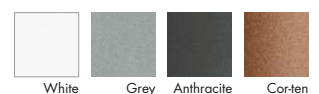





ACCESSORIES

ANTI-GLARE ACCESSORIES



Honeycomb louvre built into the lighting fixture

order together with the lighting fixture

the honeycomb louvre can be fitted on all optics except for the 6° optics



Anti-glare hood

the anti-glare hood is available on request in the same finish as the lighting fixture

ACCESSORIES FOR INSTALLATION



Spike for in-ground installation

SIRI 1.0	WH5010	WB5010H - Anthracite 89x90 mm h 173 mm	WP0300
SIRI 1.1	WH5010	WB5010H - Anthracite 89x90 mm h 173 mm	
SIRI 1.2		WB5010H - Anthracite 89x90 mm h 173 mm	WP0300
SIRI 1.3		WB5010H - Anthracite 89x90 mm h 173 mm	
SIRI 2.0	WH5020	WB5020H - Anthracite 127x90 mm h 187 mm	WP0300
SIRI 2.1	WH5020	WB5020H - Anthracite 127x90 mm h 187 mm	
SIRI 2.2		WB5020H - Anthracite 127x90 mm h 187 mm	WP0300
SIRI 2.3		WB5020H - Anthracite 127x90 mm h 187 mm	
SIRI 3.0	WH5030	WB5030H - Anthracite 174x101 mm h 190 mm	WP0300
SIRI 3.1	WH5030		
SIRI 3.2		WB5030H - Anthracite 174x101 mm h 190 mm	WP0300

< SIRI 3.0
3000K, 23W, 30°, white

Project by / Corinne Vezzoni & Associés
Light planning by / 8'18"
thecamp, Aix-en-Provence, France





PROJECTORS FOR OUTDOOR APPLICATIONS DETAIL AND FACADE LIGHTING

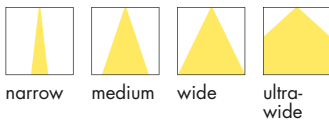

narrow

medium

wide

ultra-wide

Ø30 mm

Ø60 mm

Ø84 mm

Ø109 mm

CONSTANT CURRENT



SPOT 1.0 p. 275
max 2W max 500mA



CONSTANT VOLTAGE



SPOT 1.6 p. 275
2W 24Vdc



MAINS VOLTAGE



SPOT 2.4 p. 276
8W 230Vac
2700K 3000K 4000K



SPOT 3.4 p. 277
15W 230Vac
2700K 3000K 4000K



SPOT 4.4 p. 279
22W/32W 230Vac
2700K 3000K 4000K

UNDERWATER

SPOT 316L p. 752

< SPOT 2.4
3000K, 8W, 58°, white, with asymmetrical snoot
Project by / arch. **Ciro Alfredo Matarante**
Photo by / **Alessio Tamborini**
Private residence, Foggia, Italy



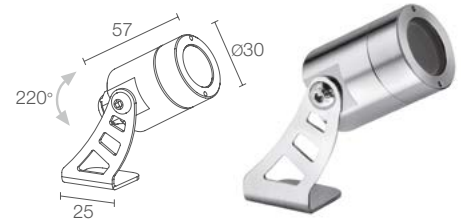
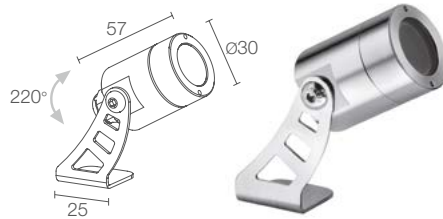
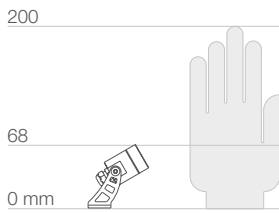

SPOT 1.0



POWER / POWER SUPPLY CODE

max 2W max 500mA
CF1012

2W 24Vdc

CF1600

LED COLOUR

F - 2700K
5 - 3000K
9 - 4000K
0 - 5000K
1 - blue

F - 2700K
5 - 3000K
9 - 4000K
0 - 5000K
1 - blue

OPTICS

S - 10°
V - 19° sharp
M - 20°
L - 40°
T - 54° sharp

S - 10°
V - 19° sharp
M - 20°
L - 40°
T - 54° sharp

POWER CABLES

includes 1.5 m neoprene cable
H05RN-F 2x0.35/0.75 Ø6.3 mm
1 - 5 m
2 - 10 m
3 - 15 m
4 - 20 m

includes 1.5 m neoprene cable
H05RN-F 2x0.35/0.75 Ø6.3 mm
1 - 5 m
2 - 10 m
3 - 15 m
4 - 20 m

LUMEN OUTPUT AT SOURCE 145 lm (3000K, 500mA)

145 lm (3000K)

DELIVERED LUMEN OUTPUT 88 lm (3000K, 500mA, 20°)

88 lm (3000K, 20°)

NO. AND TYPE OF LED 1 power LED
1/4 ANSI BIN (white LED colour)
50000h L90 B10 (Ta 25°C)

1 power LED
1/4 ANSI BIN (white LED colour)
50000h L90 B10 (Ta 25°C)

MATERIAL body and trim in AISI 316L stainless steel
screen in transparent, tempered glass

body and trim in AISI 316L stainless steel
screen in transparent, tempered glass

POWER SUPPLY UNIT not included, see p. 904

not included, see p. 904

WIRING series

parallel

MOUNTING surface mounted (ceiling, wall, ground,
spike, strap)

surface mounted (ceiling, wall, ground,
spike, strap)

ACCESSORIES see p. 280

see p. 280

NOTES not suitable for use in swimming pools or fountains
version with elliptical optics and version certified ETL
available on request
underwater version: Spot 1.0 316L, p. 754

not suitable for use in swimming pools or fountains
version with elliptical optics and version certified ETL
available on request
underwater version: Spot 1.6 316L, p. 754

PHOTOMETRIC DATA see p. 881

see p. 881

< SPOT 1.6
2700K, 2W, 40°

Light planning by / MI10studio
Photo by / Germano Borrelli
Il Vittoriale degli Italiani, Gardone Riviera, Brescia, Italy

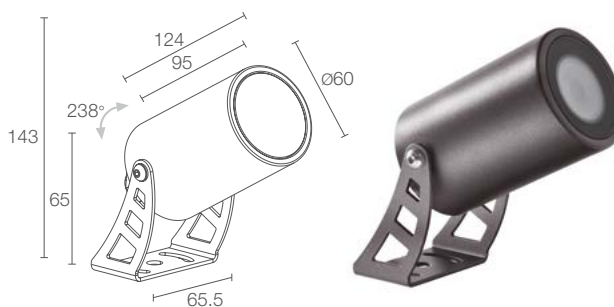
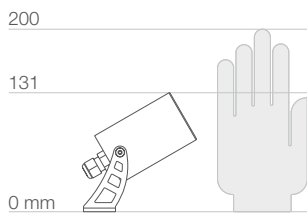

SPOT 2.4



POWER / POWER SUPPLY CODE	8W 230Vac CF24100000 O E White CF24100000 O H Anthracite
LED COLOUR	F - 2700K 5 - 3000K 9 - 4000K
OPTICS	S - 21° M - 29° L - 58°

LUMEN OUTPUT AT SOURCE	586 lm (3000K)
DELIVERED LUMEN OUTPUT	515 lm (3000K, 29°)
NO. AND TYPE OF LED	1 high-intensity power LED 3-step MacAdam 50000h L85 B10 (T _a 25°C)
MATERIAL	body in anticorodal aluminium bracket in aluminium screen in serigraphed and transparent, tempered extra-clear glass
POWER SUPPLY UNIT	built in
POWER CABLE	includes 1.5 m neoprene cable H05RN-F 3x1.00 Ø7.0 mm
MOUNTING	surface mounted (ceiling, wall, ground, spike, strap)
ACCESSORIES	see p. 280
NOTES	Casambi-compatible version, controllable with the Casambi app, available on request
PHOTOMETRIC DATA	see p. 881



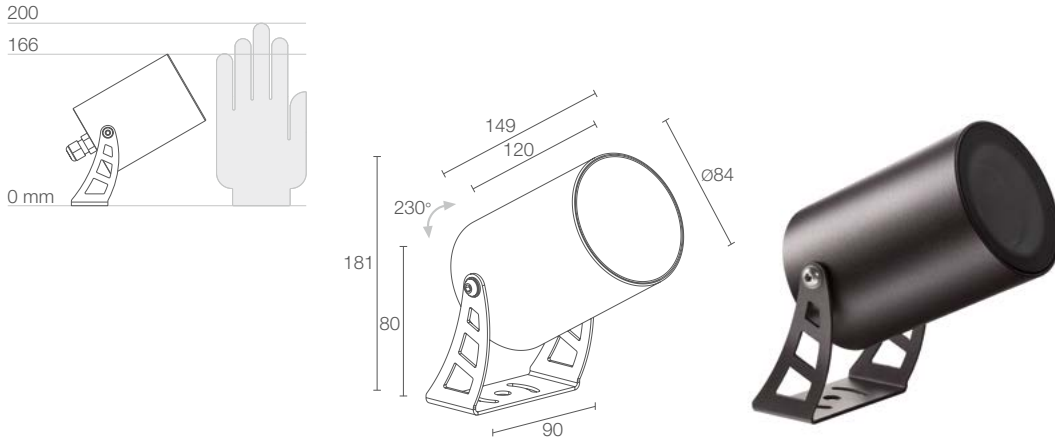

SPOT 3.4









 kg 1.20
 







POWER / POWER SUPPLY CODE	15W 230Vac CF34100000  O  E White CF34100000  O  H Anthracite
LED COLOUR	F - 2700K 5 - 3000K 9 - 4000K
OPTICS	S - 15° M - 39° L - 55°

LUMEN OUTPUT AT SOURCE	1476 lm (3000K)
DELIVERED LUMEN OUTPUT	1042 lm (3000K, 39°)
NO. AND TYPE OF LED	1 COB LED 3-step MacAdam 50000h L90 B10 (T _a 25°C)
MATERIAL	body in anticorodal aluminium bracket in aluminium screen in serigraphed and transparent, tempered extra-clear glass
POWER SUPPLY UNIT	built in
POWER CABLE	includes 1.5 m neoprene cable H05RN-F 3x1.00 Ø7.0 mm
MOUNTING	surface mounted (ceiling, wall, ground, spike, strap)
ACCESSORIES	see p. 280
NOTES	Casambi-compatible version, controllable with the Casambi app, available on request
PHOTOMETRIC DATA	see p. 882



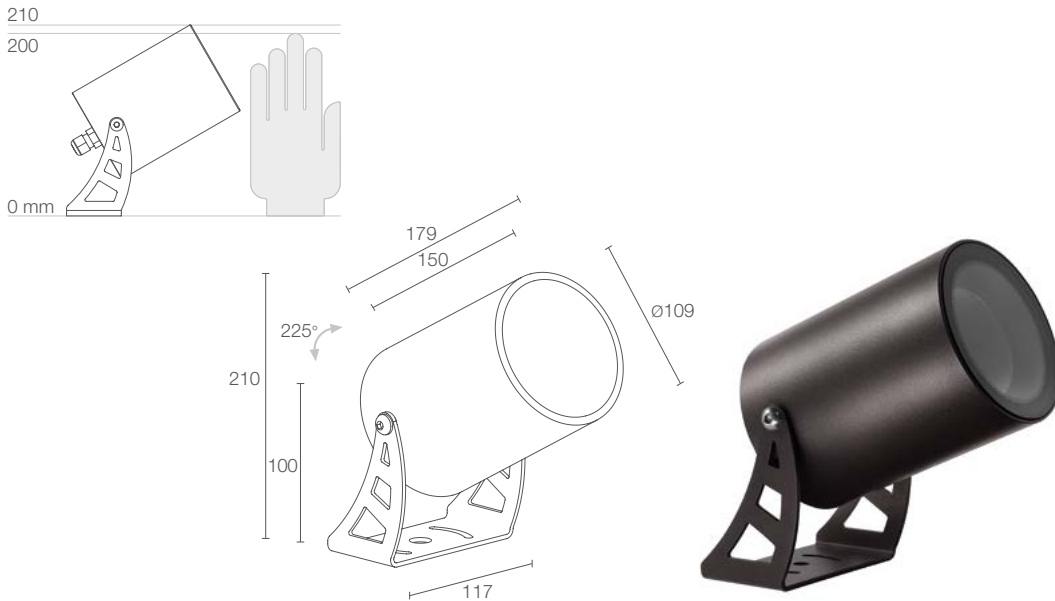



SPOT 4.4

CE CB ENEC LED TECH kg 2.50 IP66 IK08

A A+ A++ IPS







POWER SUPPLY CODE	230Vac CF441 ■ 0000 ■ 0 ■ E White CF441 ■ 0000 ■ 0 ■ H Anthracite
POWER	0 - 22W 1 - 32W
LED COLOUR	F - 2700K 5 - 3000K 9 - 4000K
OPTICS	S - 15° M - 24° L - 32° J - 54°

LUMEN OUTPUT AT SOURCE	2365 lm (3000K, 22W) 3010 lm (3000K, 32W)
DELIVERED LUMEN OUTPUT	1923 lm (3000K, 15°, 22W) 2450 lm (3000K, 15°, 32W)
NO. AND TYPE OF LED	1 COB LED, 2-step MacAdam 50000h L90 B10 (Ta 25°C)
MATERIAL	body in anticorodal aluminium bracket in aluminium screen in sgreyserigraphed and transparent, tempered extra-clear glass
POWER SUPPLY UNIT	built in
POWER CABLE	includes 1.5 m neoprene cable H05RN-F 3x1.00 Ø7.0 mm
MOUNTING	surface mounted (ceiling, wall, ground, spike)
ACCESSORIES	see p. 280
NOTES	version with honeycomb louvre available on request Casambi-compatible version, controllable with the Casambi app, available on request
PHOTOMETRIC DATA	see p. 882

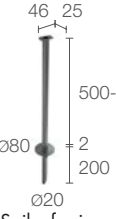

< SPOT 1.6
3000K, 2W, 40°

Project by / arch. **Ciro Alfredo Matarante**
Photo by / **Alessio Tamborini**
Private residence, Foggia, Italy

	SPOT 1.0	SPOT 1.6	SPOT 2.4	SPOT 3.4	SPOT 4.4
<p>ANTI-GLARE ACCESSORIES</p>  <p>Honeycomb louvre built into the lighting fixture order together with the lighting fixture the honeycomb louvre can be fitted on all optics except for 19° sharp and 54° sharp optics</p>  <p>Standard snoot</p>  <p>Asymmetrical snoot</p>	<p>WHO101</p> <p>WB0320I Stainless steel Ø33x25 mm</p> <p>WB0321I Stainless steel Ø33x31.5 mm</p>	<p>WH0101</p> <p>WB0320I Stainless steel Ø33x25 mm</p> <p>WB0321I Stainless steel Ø33x31.5 mm</p>	<p>WB1001E White WB1001H Anthracite Ø64.5x70 mm</p> <p>WB1002E White WB1002H Anthracite Ø64.5x90 mm</p>	<p>WB8010E White WB8010H Anthracite Ø90x85 mm</p> <p>WB8020E White WB8020H Anthracite Ø85x92 mm</p>	<p>WB1101E White WB1101H Anthracite Ø115x85 mm</p> <p>WB1102E White WB1102H Anthracite Ø110x120 mm</p>
<p>ACCESSORIES FOR INSTALLATION</p>  <p>Spike for in-ground installation</p>  <p>Spike for in-ground installation</p>  <p>Spike for in-ground installation</p>  <p>Fastener strap – 5 m</p>	<p>WP0100</p> <p>WP1004</p>	<p>WP0100</p> <p>WP1004</p>	<p>WP0100</p> <p>h 500 mm WP1006E White WP1006H Anthracite</p> <p>h 800 mm WP1007E White WP1007H Anthracite</p> <p>WP1004</p>	<p>WP0100</p> <p>h 500 mm WP1006E White WP1006H Anthracite</p> <p>h 800 mm WP1007E White WP1007H Anthracite</p> <p>WP1004</p>	<p>WP0300</p>



ACCESSORIES

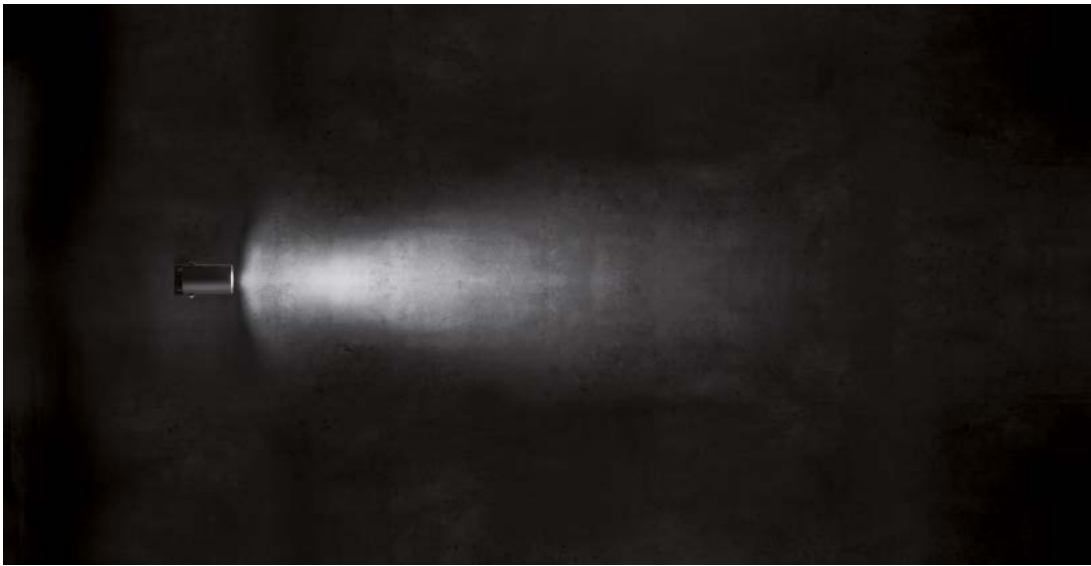

< SPOT 2.4
21°



< SPOT 2.4
29°

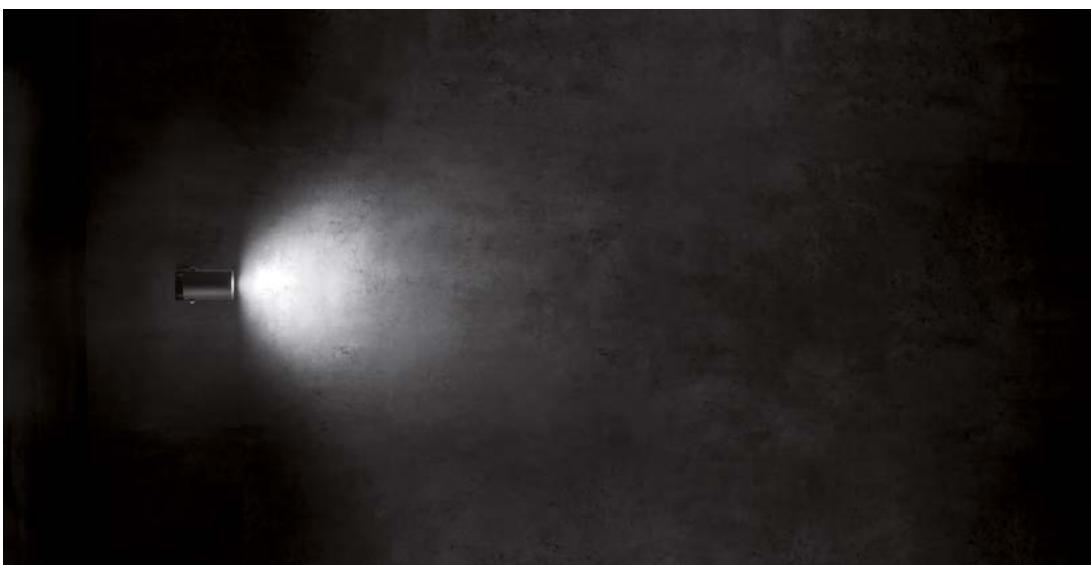

< SPOT 2.4
58°





OUTDOOR PROJECTORS ACCENT LIGHTING FOR GARDENS

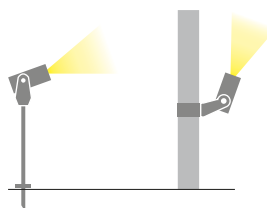

**WITHOUT BASE
FOR CONNECTIONS**



**WITH BASE
FOR CONNECTIONS**

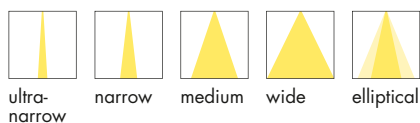

FLORI 1.0 p. 284
7W 230Vac



FLORI 1.1 p. 284
7W 230Vac

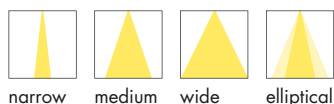

FLORI 1.2 p. 285
13W 24Vdc



FLORI 1.3 p. 285
13W 24Vdc

< **FLORI 1.0**
3000K, 7W, 15°, cor-ten
with spike for in-ground installation

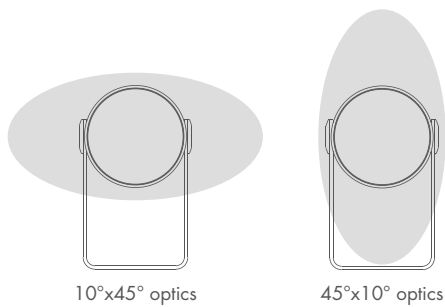

10°x45° optics

45°x10° optics

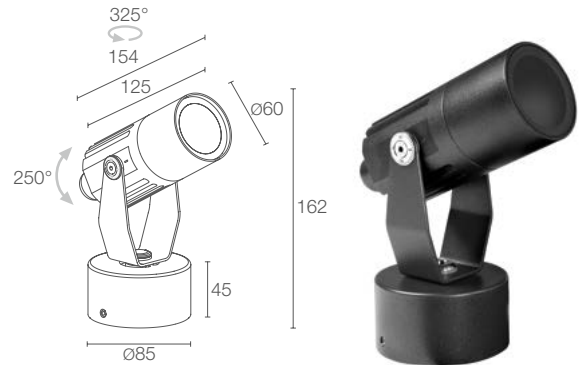
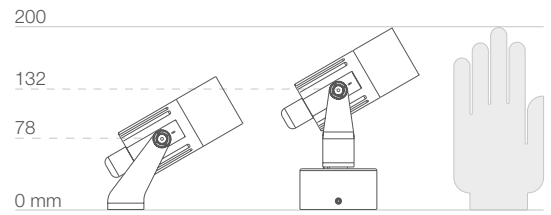
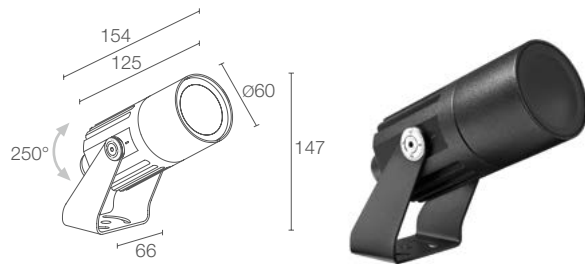

FLORI 1.0



POWER / POWER SUPPLY CODE

7W 230Vac
FS1010 E - White
FS1010 F - Grey
FS1010 H - Anthracite
FS1010 T - Cor-ten

CRI	0 - CRI 80 1 - CRI >90
LED COLOUR	F - 2700K 5 - 3000K 9 - 4000K
OPTICS	V - 9° S - 15° M - 31° L - 36° W - 10°x45° X - 45°x10°
POWER CABLES	includes 1.5 m neoprene cable H05RN-F 3x1.00 Ø7.0 mm 1 - 5 m

LUMEN OUTPUT AT SOURCE	657 lm (3000K, CRI 80)
DELIVERED LUMEN OUTPUT	366 lm (3000K, 31°, CRI 80)
NO. AND TYPE OF LED	1 high-intensity power LED 3-step MacAdam, 50000h L90 B10 (Ta 25°C)
MATERIAL	body in aluminium screen in serigraphed and transparent, tempered extra-clear glass
POWER SUPPLY UNIT	built in
MOUNTING	surface mounted (ceiling, wall, ground, spike, strap)
ACCESSORIES	see p. 289
NOTES	version with 24Vdc power supply available on request Casambi-compatible version, controllable with the Casambi app, available on request
PHOTOMETRIC DATA	see p. 829

FLORI 1.1



7W 230Vac
FS1110 E - White
FS1110 F - Grey
FS1110 H - Anthracite
FS1110 T - Cor-ten

CRI	0 - CRI 80 1 - CRI >90
LED COLOUR	F - 2700K 5 - 3000K 9 - 4000K
OPTICS	V - 9° S - 15° M - 31° L - 36° W - 10°x45° X - 45°x10°
POWER CABLES	includes 1.5 m neoprene cable H05RN-F 3x1.00 Ø7.0 mm 1 - 5 m

LUMEN OUTPUT AT SOURCE	657 lm (3000K, CRI 80)
DELIVERED LUMEN OUTPUT	366 lm (3000K, 31°, CRI 80)
NO. AND TYPE OF LED	1 high-intensity power LED 3-step MacAdam, 50000h L90 B10 (Ta 25°C)
MATERIAL	body in aluminium screen in serigraphed and transparent, tempered extra-clear glass
POWER SUPPLY UNIT	built in
MOUNTING	surface mounted (ceiling, wall, ground)
ACCESSORIES	see p. 289
NOTES	version with 24Vdc power supply available on request Casambi-compatible version, controllable with the Casambi app, available on request
PHOTOMETRIC DATA	see p. 829

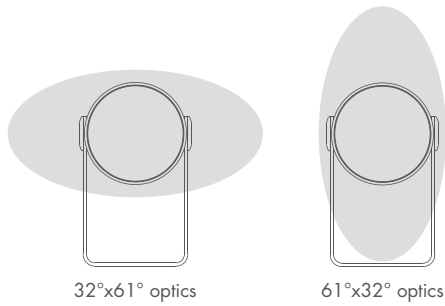

32°x61° optics

61°x32° optics

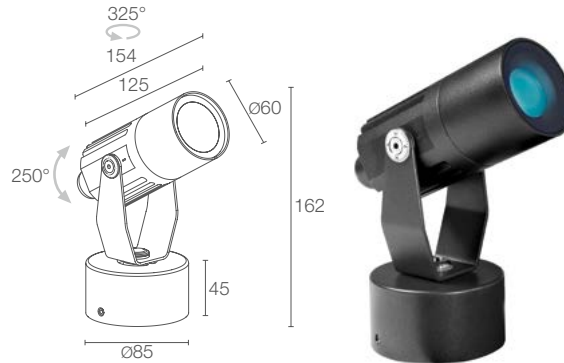
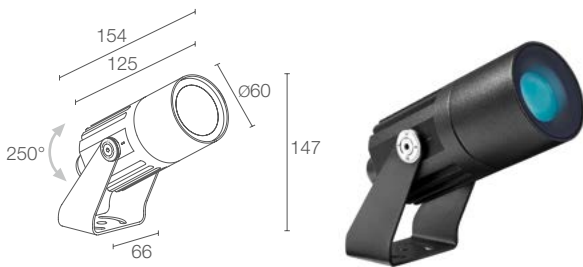

FLORI 1.2

FLORI 1.3



13W 24Vdc
FS1200 7 E White
FS1200 7 F Grey
FS1200 7 H Anthracite
FS1200 7 T Cor-ten

13W 24Vdc
FS1300 7 E White
FS1300 7 F Grey
FS1300 7 H Anthracite
FS1300 7 T Cor-ten

RGBW

RGBW

S - 24°
M - 33°
L - 60°
W - 32°x61°
X - 61°x32°

S - 24°
M - 33°
L - 60°
W - 32°x61°
X - 61°x32°

includes 1.5 m FEP+RUB cable
 (equivalent to H05RN-F) 6x0.50/0.50 Ø6.3 mm

includes 1.5 m FEP+RUB cable
 (equivalent to H05RN-F) 6x0.50/0.50 Ø6.3 mm

512 lm, R: 88 lm G: 160 lm B: 52 lm
 W: 212 lm (4000K)

512 lm, R: 88 lm G: 160 lm B: 52 lm
 W: 212 lm (4000K)

304 lm, R: 52 lm G: 95 lm B: 31 lm
 W: 126 lm (4000K, 33°)

304 lm, R: 52 lm G: 95 lm B: 31 lm
 W: 126 lm (4000K, 33°)

1 RGBW LED group
 50000h L85 B10 (Ta 25°C)

1 RGBW LED group
 50000h L85 B10 (Ta 25°C)

body in aluminium
 screen in serigraphed and transparent, tempered
 extra-clear glass

body in aluminium
 screen in serigraphed and transparent, tempered
 extra-clear glass

not included, see p. 904 and 917

not included, see p. 904 and 917

surface mounted (ceiling, wall, ground, spike, strap)

surface mounted (ceiling, wall, ground)

see p. 289

see p. 289

Casambi-compatible version, controllable with
 the Casambi app, available on request

Casambi-compatible version, controllable with
 the Casambi app, available on request

see p. 829

see p. 829









PIZ LAILA

2100



ACCESSORIES

ANTI-GLARE ACCESSORIES



WHA0005

Flori 1.0 / 1.1
(15°, 31°, 36°, 10°x45° e 45°x10° optics)

WH0203

Flori 1.0 / 1.1 (9° optics)
Flori 1.2 / 1.3

Honeycomb louvre
built into the lighting fixture

order together with
the lighting fixture

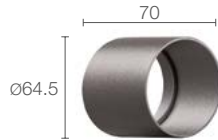

WB1001E - White
WB1001F - Grey
WB1001H - Anthracite
WB1001T - Cor-ten
Standard snoot

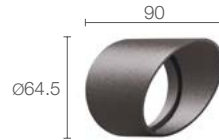

WB1002E - White
WB1002F - Grey
WB1002H - Anthracite
WB1002T - Cor-ten
Asymmetrical snoot



WB1003N - Black
Barn doors

ACCESSORIES FOR INSTALLATION Flori 1.0 / 1.2



WP0100

Spike for
in-ground installation

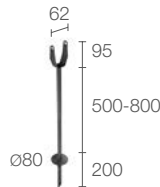

h 500 mm
WP1001E - White
WP1001F - Grey
WP1001H - Anthracite
WP1001T - Cor-ten
h 800 mm
WP1002E - White
WP1002F - Grey
WP1002H - Anthracite
WP1002T - Cor-ten
Spike with bracket for
in-ground installation



h 420 mm
WP1003E - White
WP1003F - Grey
WP1003H - Anthracite
WP1003T - Cor-ten
Arm with bracket for
wall-mounted installation



WP1004
Fastener
strap - 5 m

Flori mounted on spike with bracket
for in-ground installation



page 286
FLORI 1.0
3000K, 7W, 31°, anthracite
with spike for in-ground installation

< **FLORI 1.2**
RGBW, 13W, 32°x61°, anthracite

Photo by / ©Federico Covre
Club Moritzino, Piz La Ila, Badia, Bolzano, Italy



290

L&L Luce&Light



OUTDOOR PROJECTORS ARCHITECTURAL LIGHTING FOR LARGE BUILDINGS

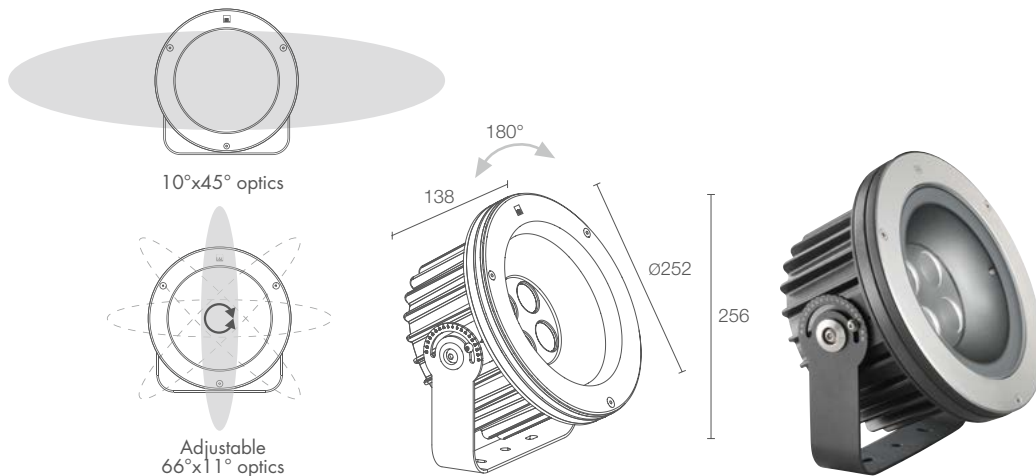

STRA P 1.0

CE ENEC LED TECH kg 6.00 IP66 IK10 0/1-10V
A A+ A++ IPS PID SPD



elliptical optics,
adjusted manually
with magnet

POWER / POWER SUPPLY CODE	37W 230Vac ON/OFF PS1010 ■ ■ ■ H Anthracite 37W 230Vac 0/1-10V PS1010 ■ ■ ■ H R Anthracite
CRI	0 - CRI 80 1 - CRI >90
LED COLOUR	F - 2700K 5 - 3000K 9 - 4000K
OPTICS	V - 11° S - 14° M - 30° L - 37° W - 10°x45° X - 66°x11° adjustable
LUMEN OUTPUT AT SOURCE	3402 lm (3000K, CRI 80)
DELIVERED LUMEN OUTPUT	2024 lm (3000K, 30°, CRI 80) 2205 lm (3000K, 66°x11°, CRI 80)
NO. AND TYPE OF LED	4 high-intensity power LEDs 3-step MacAdam, 50000h L90 B10 (Ta 25°C)
MATERIAL	body in die-cast aluminium trim in AISI 316L stainless steel screen in serigraphed and transparent, tempered extra-clear glass
POWER SUPPLY UNIT	built in
POWER CABLES	includes 1,5 m neoprene cable H05RN-F 3x1.00 Ø7.0 mm
MOUNTING	surface mounted (ceiling, wall, ground)
ACCESSORIES	see p. 293
FEATURES	66°x11° optics adjustable through 360° using magnet included
NOTES	Stra 1.0 recessed version p. 136 DALI version available on request Casambi-compatible version, controllable with the Casambi app, available on request
PHOTOMETRIC DATA	see p. 890



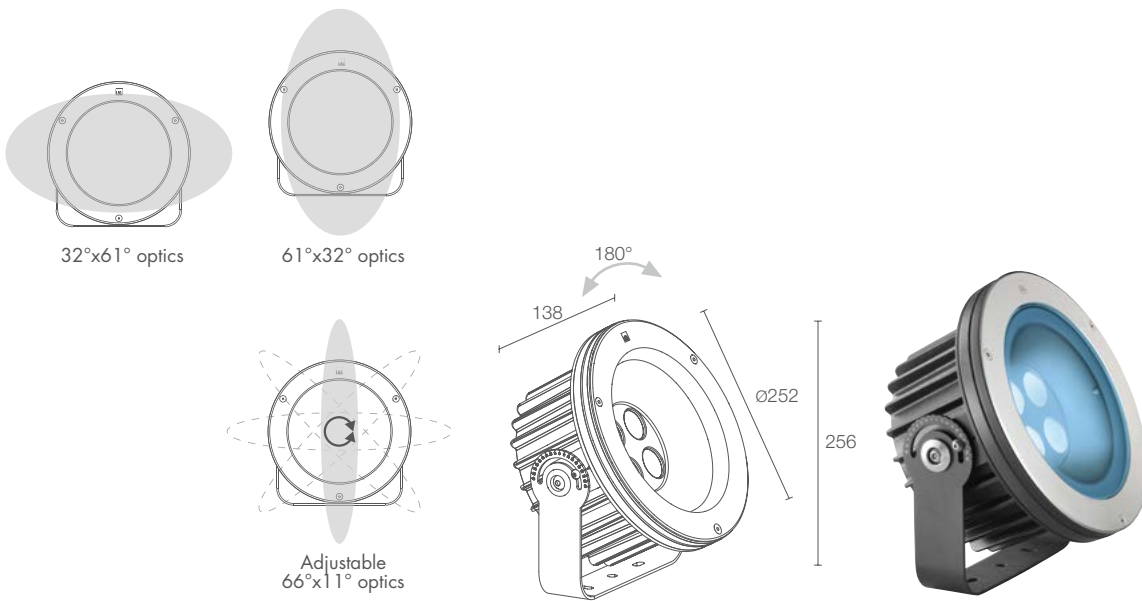

STRA P 5.0



elliptical optics,
adjusted manually
with magnet

POWER / POWER SUPPLY CODE	39W 24Vdc PS5000 7 ■ H Anthracite
OPTICS	S - 24° M - 33° L - 60° W - 32°x61° Z - 61°x32° X - 66°x11° adjustable
LED COLOUR	RGBW
LUMEN OUTPUT AT SOURCE	2048 lm, R: 352 lm G: 640 lm B: 208 lm W: 848 lm (4000K)
DELIVERED LUMEN OUTPUT	1216 lm, R: 209 lm G: 380 lm B: 123 lm W: 504 lm (4000K, 33°)
NO. AND TYPE OF LED	4 RGBW LED groups 50000h L85 B10 (Ta 25°C)
MATERIAL	body in die-cast aluminium trim in AISI 316L stainless steel screen in serigraphed and transparent, tempered extra-clear glass
POWER SUPPLY UNIT	not included, see p. 904 and 917
POWER CABLES	includes 1.5 m FEP+RUB cable (equivalent to H05RN-F) 6x0.50/0.50 Ø6.3 mm
MOUNTING	surface mounted (ceiling, wall, ground)
FEATURES	66°x11° optics adjustable through 360° using magnet included
NOTES	recessed version: Stra 5.0, p. 138
PHOTOMETRIC DATA	see p. 890



Anthracite



ACCESSORIES

ANTI-GLARE ACCESSORIES



WH0610

Honeycomb louvre
built into the lighting fixture

order together with
the lighting fixture

the honeycomb louvre can be fitted on all
optics except for the 66°x11° optics

ACCESSORIES FOR INSTALLATION



WN7100

Anti-fall kit

for spare parts, see p. 932

▼
STRA P 1.0
2700K, 37W, 30°

Light planning and product distribution by / Mise en Scène Éclairage
Project and installation by / VinJay-Studio
Photo by / Lisa Ricciotti
La Villa Madie, Cassis, France

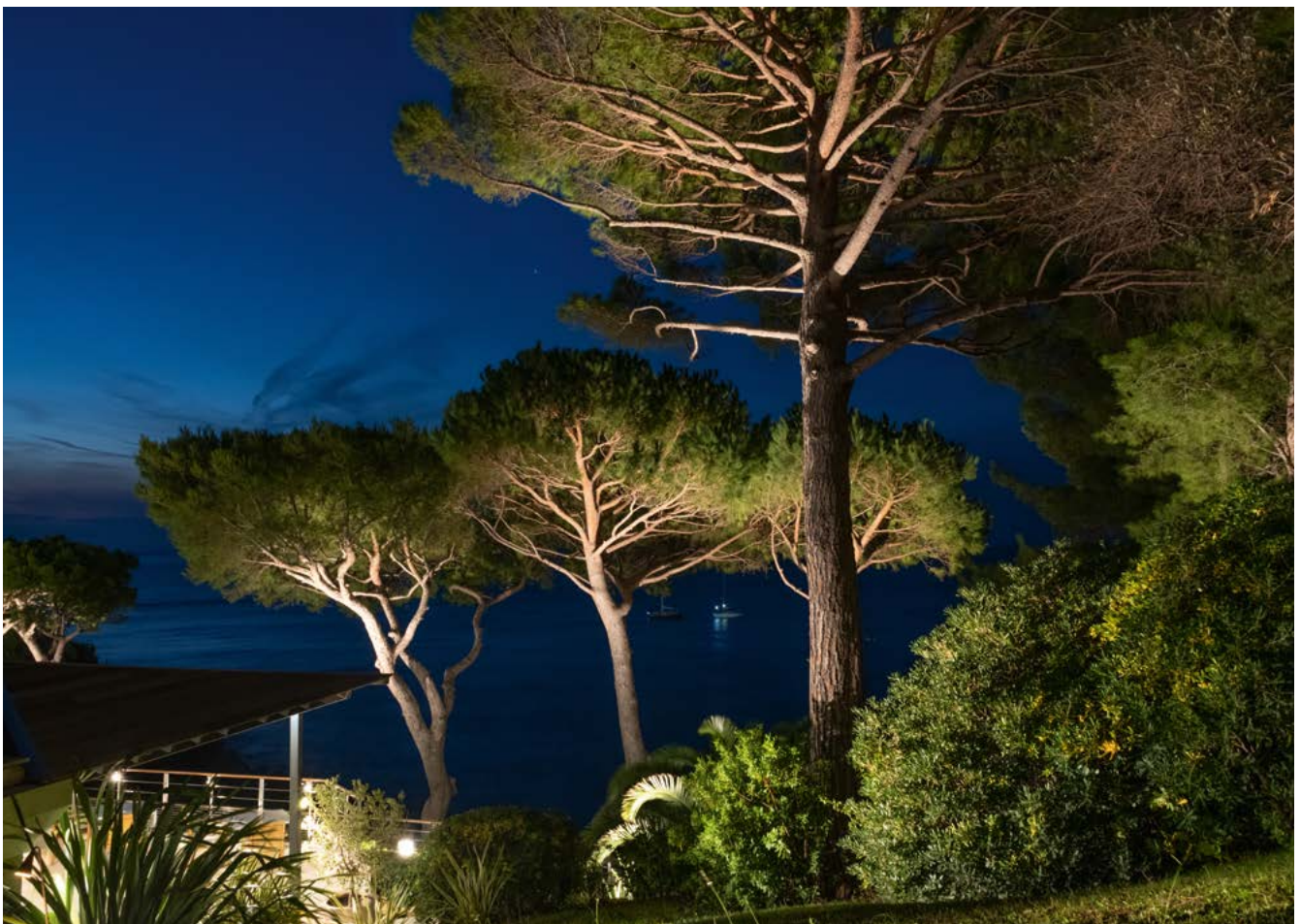

HOTEL BRISTOL





OUTDOOR PROJECTORS FOR HIGHLIGHTING ARCHITECTURAL ELEMENTS IN FACADES

2700K 3000K 4000K blue

RGBW

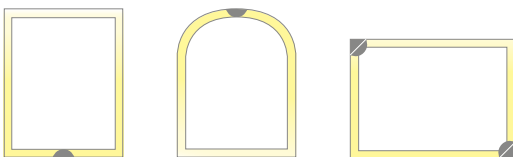

LYSS MINI 1.0 p. 298
3W 24Vdc

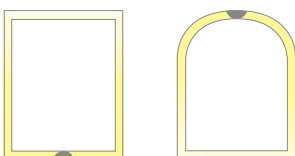

LYSS 1.0 p. 299
5W 230Vac
7W 230Vac

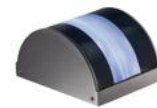

LYSS 2.0 p. 299
19W 24Vdc

< LYSS MINI 1.0
3000K, 3W, satin 9°x160°, anthracite
Light planning by / Ida Hågensen (SML Lighting)
Photo by / Tomasz Majewski
Hotel Bristol, Oslo, Norway



IP65
SUITABLE FOR OUTDOOR INSTALLATIONS

BUILT-IN PROTECTION SYSTEMS:



IPS
INTELLIGENT PROTECTION SYSTEM
(LYSS MINI 1.0)



PID
PROTECTIVE IMPEDANCE DEVICE
(LYSS 1.0 / 2.0)



COLORSENSE TECHNOLOGY CHROMATICALLY
BLENDS AND SHAPES RGBW LIGHT,
PRODUCING A 12°x160° BEAM



6-STEP MATERIAL PROTECTION, AND OXIDATION
AND CORROSION RESISTANCE

Low-copper-content aluminium alloy EN AB 47100
Preparation for painting
Epoxy paint
Polyester paint
Paints compliant with Qualicoat automotive coating standard
Salt spray tested (over 1000 hours) (Lyss 1.0 / 2.0)
Salt spray tested (over 2000 hours) (Lyss Mini 1.0)



IK07 (LYSS MINI 1.0)
BODY MADE OF THERMALLY CONDUCTIVE TECHNOPOLYMER
TO GUARANTEE EXCELLENT RESISTANCE
TO CORROSION EVEN IN HARSH (SALINE) ENVIRONMENTS



IK05 (LYSS 1.0)
SCREEN IN SERIGRAPHED GLASS WITH
EXCELLENT SCRATCH RESISTANCE.
BODY IN LOW-COPPER-CONTENT DIE-CAST
ALUMINIUM ALLOY EN AB 47100 FOR EXCELLENT
CORROSION RESISTANCE, BUILT-IN POWER SUPPLY UNIT



IK06 (LYSS 2.0)
SCREEN MADE OF POLYCARBONATE WITH ANTI-UV COATING,
CHARACTERISED BY EXCELLENT IMPACT RESISTANCE.
BODY IN LOW-COPPER-CONTENT DIE-CAST ALUMINIUM ALLOY
EN AB 47100 FOR EXCELLENT CORROSION RESISTANCE

LYSS 1.0 / 2.0
PLATE ADJUSTABLE BY 5°
TO ALIGN LIGHT BEAM WITH
INSTALLATION SURFACE

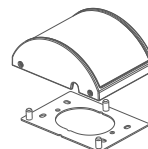

LYSS'S COMPACT DIMENSIONS MAKE IT UNOBTRUSIVE
AND THUS SUITABLE FOR FACADE INSTALLATIONS



UNIQUE SELLING POINTS



LYSS MINI 1.0



LYSS 1.0



RAL FINISH
ON REQUEST

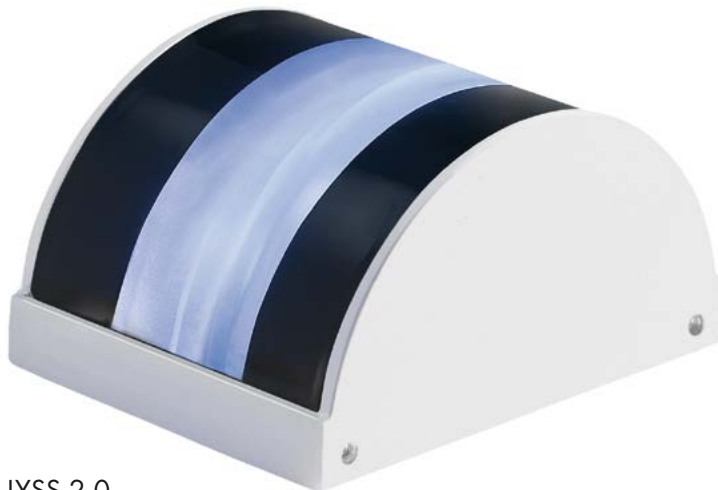

LYSS 2.0



GREY



ANTHRACITE

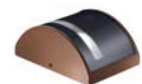

COR-TEN



SEMICIRCULAR
UNIFORM BLADE
OF LIGHT:
SHARP, TRANSPARENT
OPTICS, 10°x180°



SEMICIRCULAR
UNIFORM BLADE
OF LIGHT:
SOFT, FROSTED
OPTICS, 20°x180°

✓
LYSS 1.0
 3000K, 7W, clear 10°x180°, white
SIRI 2.0
 3000K, 16W, 40°, white
NEVA 2.1
 3000K, 16W, 45°

Project by / Amatori Architettura d'Interni
 Architecture by / arch. Gino Valle
 Light planning by / Litek
 BVR Banca - Banche Venete Riunite, Schio headquarters,
 Vicenza, Italy

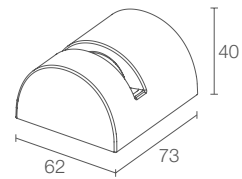

LYSS MINI 1.0



POWER / POWER SUPPLY CODE

3W 24Vdc
LM10000 ■ ■ ■ **E** White
LM10000 ■ ■ ■ **F** Grey
LM10000 ■ ■ ■ **H** Anthracite
LM10000 ■ ■ ■ **T** Cor-ten

LED COLOUR	F - 2700K 5 - 3000K 9 - 4000K 1 - blue
OPTICS	Z - clear 8°x160° Y - satin 9°x160°

LUMEN OUTPUT AT SOURCE	246 lm (3000K)
DELIVERED LUMEN OUTPUT	67 lm (3000K, 8°x160°)
NO. AND TYPE OF LED	1 power LED 1/4 ANSI BIN (white LED colour) 50000h L95 B10 (Ta 25°C)
MATERIAL	body in thermally conductive plastic
POWER SUPPLY UNIT	not included, see p. 904
POWER CABLES	includes 1.5 m neoprene cable 05RN-F 2x0.35 Ø4.6 mm
MOUNTING	surface mounted (windowsill, arch, corner)
ACCESSORIES	see p. 303
NOTES	
PHOTOMETRIC DATA	see p. 851

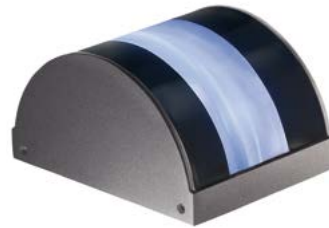
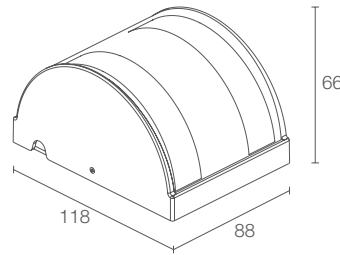
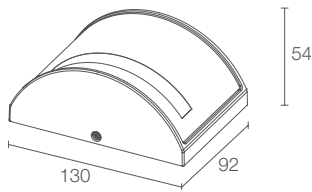

LYSS 1.0



5W 230Vac
LY1010 ■ ■ ■ E White
LY1010 ■ ■ ■ F Grey
LY1010 ■ ■ ■ H Anthracite
LY1010 ■ ■ ■ T Cor-ten

7W 230Vac
LY1011 ■ ■ ■ E White
LY1011 ■ ■ ■ F Grey
LY1011 ■ ■ ■ H Anthracite
LY1011 ■ ■ ■ T Cor-ten

■ **F** - 2700K
5 - 3000K
9 - 4000K
1 - blue

■ **Z** - clear 10°x180°
Y - satin 20°x180°

347 lm (3000K, 5W)
 530 lm (3000K, 7W)

109 lm (3000K, 20°x180°, 5W)
 170 lm (3000K, 20°x180°, 7W)

2 power LEDs
 1/4 ANSI BIN (white LED colour)
 50000h L95 B10 (Ta 25°C)

body in die-cast aluminium
 screen in serigraphed extra-clear glass

built in

includes 1.5 m neoprene cable
 H05RN-F 3x1.00 Ø7.0 mm

surface mounted (windowsill, arch)

see p. 303

Casambi-compatible version, controllable with
 the Casambi app, available on request

see p. 851

LYSS 2.0



19W 24Vdc
LY2000 7 U E White
LY2000 7 U F Grey
LY2000 7 U H Anthracite
LY2000 7 U T Cor-ten

RGBW

12°x160°

1024 lm, R: 124 lm G: 340 lm B: 120 lm W: 440 lm
 (4000K)

256 lm, R: 31 lm G: 85 lm B: 30 lm W: 110 lm
 (4000K)

4 RGBW LED groups
 50000h L80 B10 (Ta 25°C)

body in die-cast aluminium
 screen in polycarbonate

not included, see p. 904 and 917

includes 1.5 m FEP+RUB cable (equivalent to H05RN-F)
 6x0.50/0.50 Ø6.3 mm

surface mounted (windowsill, arch)

see p. 303

see p. 851











ACCESSORIES

ACCESSORIES FOR INSTALLATION



WC0301
Optional outer casing
(Lyss 1.0 / 2.0)

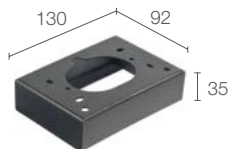

WD0500E - White
WD0500F - Grey
WD0500H - Anthracite
WD0500T - Cor-ten
Connection housing
(Lyss 1.0)



WD0600E - White
WD0600F - Grey
WD0600H - Anthracite
WD0600T - Cor-ten
Connection housing
(Lyss 2.0)



WD0800E - White
WD0800F - Grey
WD0800H - Anthracite
WD0800T - Cor-ten
Base for corners
(Lyss Mini 1.0)

page 300

LYSS MINI 1.0
3000K, 3W, satin 9°x160°, white
with base for corners

SPOT 1.0
3000K, 2W, 10°

INTONO 2.1
3000K, 6W, 11°, white

Project by / Saraiva+Associados
Light planning by / Astratec
Photo by / Nicole Sánchez
The Editory Riverside Santa Apolónia Hotel
Lisbon, Portugal

< **LYSS 1.0**
3000K, 5W, transparent 10°x180°, white
BRIGHT 2.5
3000K, 5W, customized version with 24° optics

Light planning by / Cristian Turra
Private residence, Iseo, Brescia, Italy

▽
LYSS 2.0
RGBW, 19W, white

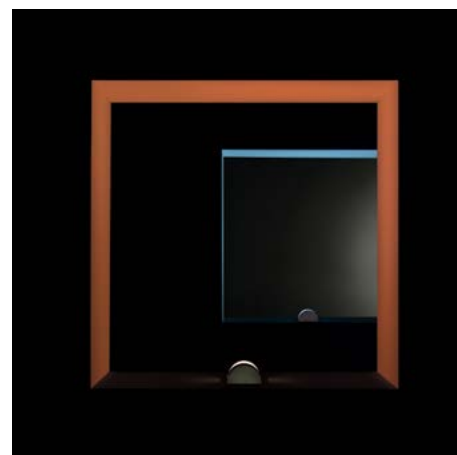





OUTDOOR PROJECTOR ADJUSTABLE BEAM AND INTERCHANGEABLE OPTICAL FILTERS

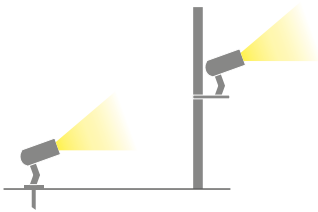

2700K 3000K 4000K

**DIMMABLE WITH
REMOTE PSU**

**BUILT-IN POWER
SUPPLY UNIT**

**BUILT-IN POWER
SUPPLY UNIT
DALI 0/1-10V**

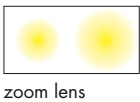

AKRO 1.0 p. 308
max 37W max 1050mA



AKRO 1.1 p. 309
43W 230Vac



AKRO 1.2 p. 309
43W 230Vac

< **AKRO 1.1**
with optical accessories and
anti-glare accessories



GOOD DESIGN
AWARD 2017



IP66

IP66
SUITABLE FOR OUTDOOR APPLICATIONS

BUILT-IN PROTECTION SYSTEMS:



IPS
INTELLIGENT PROTECTION SYSTEM
(AKRO 1.0)



PID
PROTECTIVE IMPEDANCE DEVICE
(AKRO 1.1 / 1.2)



INTERNAL ANTI-REFLECTIVE
ASPHERIC OPTICAL SYSTEM
IN BK7 BOROSILICATE GLASS

IK06

IK06
SCREEN IN 4-MM-THICK TRANSPARENT
EXTRA-CLEAR GLASS, HIGH TRANSMITTANCE
TO ENSURE CHROMATIC UNIFORMITY,
AND TEMPERED FOR EXCELLENT
RESISTANCE TO KNOCKS AND SCRATCHES

BODY IN LOW-COPPER-CONTENT
ANTICORODAL ALUMINIUM 6082
FOR EXCELLENT RESISTANCE
TO CORROSION, PRODUCED
ENTIRELY ON A CNC LATHE

SALT SPRAY TESTED
(over 1500 hours)

< OPTICAL RANGES:
13°–32°, 16°–42°

< ZOOM LENS
TO ADJUST THE LIGHT
BEAM MANUALLY

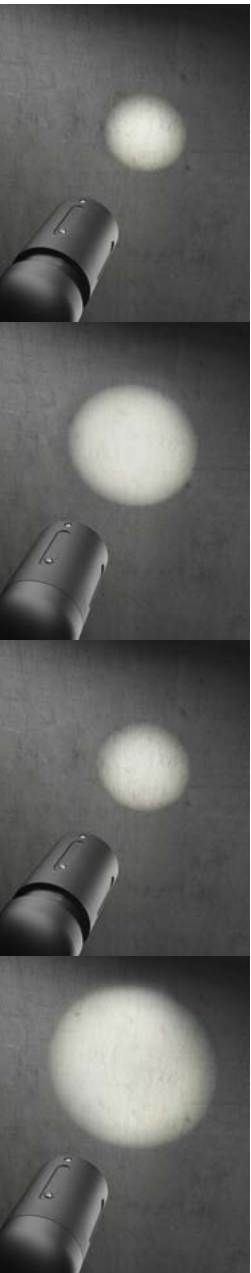



UNIQUE SELLING POINTS



GRADUATIONS
IN THREE DIFFERENT
POINTS ON
THE BODY TO
ENSURE PRECISE
BEAM POSITIONING



FILTER
REPLACEMENT



MOCK-UP CARTRIDGE
FOR LIGHTING TRIALS



IP66 CARTRIDGE
INCLUDED

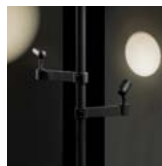

ARM FOR POLE
MOUNTING



WIDE RANGE OF FILTERS
(DICHROIC, ELLIPTICAL,
DIFFUSION, COLOUR-
TEMPERATURE CONVERSION,
HONEYCOMB LOUVRE)

✓
AKRO 1.1
 3000K, 43W, optical range 13°–32°
 with diffusion filter
 Villa Da Porto Casarotto
 Dueville, Vicenza, Italy



AKRO 1.0

CE ENEC LED TEC III kg 4.00 IP66 IK06
 A A+ A++ IPS

POWER / POWER SUPPLY CODE	max 37W max 1050mA AK1000 ■ ■ ■ N Anodized black
CRI	0 - CRI 80 1 - CRI >90
LED COLOUR	F - 2700K 5 - 3000K 9 - 4000K
OPTICS	R1 - optical range 13°–32° R2 - optical range 16°–42°

LUMEN OUTPUT AT SOURCE	3260 lm (3000K, 1050mA, CRI 80)
NO. AND TYPE OF LED	1 high-intensity COB LED 3-step MacAdam, 50000h L90 B10 (Ta 25°C)
MATERIAL	body in black-anodized Anticorodal aluminium screen in transparent and tempered extra-clear glass
POWER SUPPLY UNIT	not included, see p. 904
POWER CABLES	includes 5 m neoprene cable H05RN-F 2x0.35/0.75 Ø6.3 mm
WIRING	series
MOUNTING	surface mounted (ceiling, wall, ground, spike, pole)
ACCESSORIES	see p. 311
FEATURES	dimnable with remote PSU
NOTES	dichroic filters available on request in non-standard colouring
PHOTOMETRIC DATA	see p. 778



AKRO 1.1

CE EAC LED TECH kg 5.60 IP66 IK06

A A+ A++ PID

43W 230Vac
AK1110 ■ ■ ■ **N** Anodized black

■	0 - CRI 80 1 - CRI >90
■	F - 2700K 5 - 3000K 9 - 4000K
■	R1 - optical range 13°-32° R2 - optical range 16°-42°

3260 lm (3000K, CRI 80)

1 high-intensity COB LED
 3-step MacAdam, 50000h L90 B10 (Ta 25°C)

body in black-anodized Anticorodal aluminium
 screen in transparent and tempered extra-clear glass

built in

none

mains voltage

surface mounted (ceiling, wall, ground)

see p. 311

dichroic filters available on request
 in non-standard colouring

see p. 778

AKRO 1.2

CE EAC LED TECH kg 6.50 IP66 IK06

A A+ A++ PID DALI PUSH 0/1-10V

43W 230Vac DALI + 0/1-10V + PUSH
AK1210 ■ ■ ■ **ND** Anodized black

■	0 - CRI 80 1 - CRI >90
■	F - 2700K 5 - 3000K 9 - 4000K
■	R1 - optical range 13°-32° R2 - optical range 16°-42°

3260 lm (3000K, CRI 80)

1 high-intensity COB LED
 3-step MacAdam, 50000h L90 B10 (Ta 25°C)

body in black-anodized Anticorodal aluminium
 screen in transparent and tempered extra-clear glass

built in

none

mains voltage

surface mounted (ceiling, wall, ground)

see p. 311

dimnable

dichroic filters available on request
 in non-standard colouring
 Casambi-compatible version, controllable with
 the Casambi app, available on request

see p. 778

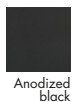

Anodized black





ACCESSORIES

ANTI-GLARE ACCESSORIES

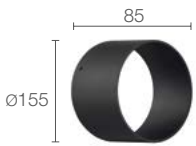

WB1101N - Black
Standard snoot

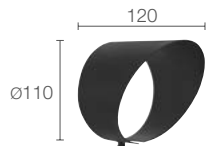

WB1102N - Black
Asymmetrical snoot



WB1103N - Black
Barn doors

OPTICAL ACCESSORIES



WR0001 - Red
WR0002 - Green
WR0003 - Blue
WR0004 - Orange
Dichroic filter



WR0010 - Diffusion
WR0020 - Elliptical
Optical filter



WR0030 - Variation towards warm white light
WR0031 - Variation towards cold white light
Colour temperature conversion filter

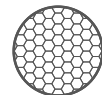

WH0506
Honeycomb louvre

- order together with the cartridge extractor tool WE0300
- only one WE0300 accessory is required with orders for multiple optical filters
- Akro can house up to 2 filters

ACCESSORIES FOR INSTALLATION



WP0300
Spike for in-ground installation
(Akro 1.0)



WP1005N
Arm for pole mounting
(Akro 1.0)



WE0300
Accessory for extracting IP66 cartridge



WR0100
Mock-up cartridge

for spare parts, see p. 932

^ **AKRO 1.0**
3000K, 37W, with elliptical filter
and orange, blue, red, green dichroic filters

















< **AKRO 1.0**
3000K, 37W, 13°-32° optical range
with elliptical filter











WALL MOUNTED FOR OUTDOOR APPLICATIONS

BERICA OUT p. 316	1
INTONO p. 324	2
GEKO p. 336	3
KOCCA p. 342	4
ELLA OUT p. 350	5
UPDOWN p. 356	6
BROM p. 364	7
CUBE W p. 368	8



	BEAM	LIGHT COLOUR	POWER
BERICA OUT see p. 316 	DIFFUSE VERSION double beam OPTICS VERSION double beam	 2200K 2700K 3000K 4000K	15–56W
INTONO see p. 324 	DIFFUSE VERSION single beam / double beam OPTICS VERSION single beam / double beam WITH SPEAKER	 2700K 3000K 4000K	3–38W
GEKO see p. 336 	DIFFUSE VERSION single beam / double beam OPTICS VERSION single beam / double beam	 2700K 3000K 4000K 5000K	10–28W
KOCCA see p. 342 	DIFFUSE VERSION 1 / 2 / 4 beam OPTICS VERSION 1 / 2 / 3 / 4 beam	 2700K 3000K 4000K	4–40W
ELLA OUT see p. 350 	DIFFUSE VERSION single beam	 2700K 3000K 4000K	7–19W
UPDOWN see p. 356 	OPTICS VERSION 1 / 2 / 4 beam	 2700K 3000K 4000K blue RGB	3–6W (RGB light) 4–8W (white/blue light)
BROM see p. 364 	OPTICS VERSION single beam / double beam	 2700K 3000K 4000K	max 2–max 12W
CUBE W see p. 368 	OPTICS VERSION single beam	 2700K 3000K 4000K 5000K blue RGB	max 3W (RGB light) max 6W (white/blue light)

WALL MOUNTED FOR OUTDOOR APPLICATIONS

DELIVERED LUMEN OUTPUT (3000K)	POWER SUPPLY	IP	APPLIANCE CLASS
1444–6120 lm	MAINS VOLTAGE (built-in power supply unit) 230Vac	IP65	
128–2772 lm	CONSTANT VOLTAGE (power supply unit not included) 24Vdc MAINS VOLTAGE (built-in power supply unit) 230Vac	IP65	 
531–1662 lm	MAINS VOLTAGE (built-in power supply unit) 230Vac	IP65	
102–2524 lm	MAINS VOLTAGE (built-in power supply unit) 230Vac	IP65	
493–1478 lm	MAINS VOLTAGE (built-in power supply unit) 230Vac	IP65	
206–412 lm	CONSTANT CURRENT (power supply unit not included) max 350mA (white/RGB light) max 500mA (white/blue light) CONSTANT VOLTAGE (power supply unit not included) 24Vdc (white/blue light)	IP65	
88–502 lm	CONSTANT CURRENT (power supply unit not included) max 500mA	IP66	
295–337 lm	CONSTANT CURRENT (power supply unit not included) max 350mA (RGB light) max 500mA (white/blue light)	IP54	



OUTDOOR WALL MOUNTED DOUBLE BEAM

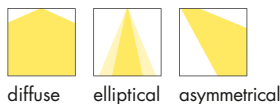

diffuse elliptical asymmetrical



2200K 2700K 3000K 4000K

OUTDOOR WALL MOUNTED

220 mm

360 mm

640 mm

CONVEX COVER



BERICA OUT 1.0
p. 318
15W 230Vac
ON/OFF



BERICA OUT 1.1
p. 319
30W 230Vac
ON/OFF, DALI



BERICA OUT 1.2
p. 319
56W 230Vac
ON/OFF, DALI

FLAT COVER



BERICA OUT 2.0
p. 320
15W 230Vac
ON/OFF



BERICA OUT 2.1
p. 321
30W 230Vac
ON/OFF, DALI



BERICA OUT 2.2
p. 321
56W 230Vac
ON/OFF, DALI

CONCAVE COVER



BERICA OUT 3.0
p. 322
15W 230Vac
ON/OFF



BERICA OUT 3.1
p. 323
30W 230Vac
ON/OFF, DALI



BERICA OUT 3.2
p. 323
56W 230Vac
ON/OFF, DALI

INDOOR WALL MOUNTED

BERICA IN
p. 608

INDOOR SUSPENDED

BERICA S
p. 668



^
BERICA OUT 1.1
 3000K, 30W, 42°x102°
 painted primer version

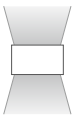
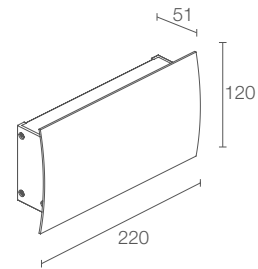

BERICA OUT 1.0



POWER / POWER SUPPLY CODE	15W 230Vac BU1010 ■ 000 ■ E White BU1010 ■ 000 ■ H Anthracite BU1010 ■ 000 ■ T Cor-ten BU1010 ■ 000 ■ 7 Primer
CRI	0 - CRI 80 1 - CRI >90
CONTROL SYSTEM	on/off
LED COLOUR	N - 2200K F - 2700K 5 - 3000K 9 - 4000K
OPTICS	OA - asymmetrical OD - diffuse LW - 42°x102° KW - 62°x100°

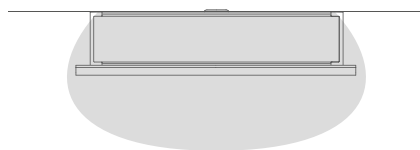

Asymmetrical optics

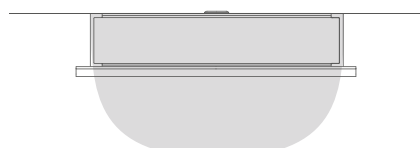

Diffuse optics



42°x102° optics

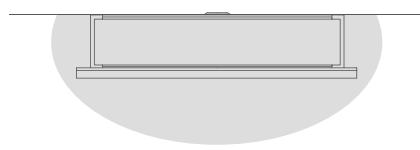

62°x100° optics

LUMEN OUTPUT AT SOURCE	1814 lm (3000K, CRI 80)
DELIVERED LUMEN OUTPUT	1444 lm (3000K, diffuse, CRI 80)
NO. AND TYPE OF LED	24 mid-power LEDs 2-step MacAdam, 50000h L80 B10 (Ta 25°C)
MATERIAL	body and cover in anticorrosional aluminium screen in grey-serigraphed and transparent, tempered extra-clear glass
POWER SUPPLY UNIT	built in
MOUNTING	surface mounted (wall)
NOTES	indoor version: Berica IN 1.0, p. 612 single-beam version available on request Casambi-compatible version, controllable with the Casambi app, available on request
PHOTOMETRIC DATA	see p. 785

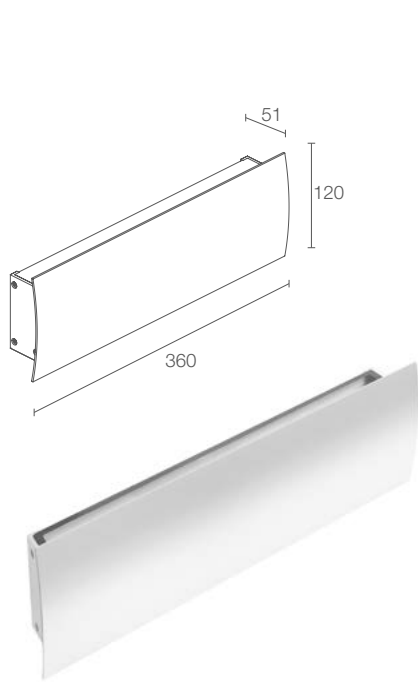

BERICA OUT 1.1

CE ENEC LED TECH IP65 IK07 DALI
 A A+ A++

30W 230Vac
BU1110 ■ ■ **00** ■ ■ **E** White
BU1110 ■ ■ **00** ■ ■ **H** Anthracite
BU1110 ■ ■ **00** ■ ■ **T** Cor-ten
BU1110 ■ ■ **00** ■ ■ **7** Primer

■	0 - CRI 80 1 - CRI >90
■	0 - on/off D - DALI
■	N - 2200K F - 2700K 5 - 3000K 9 - 4000K
■	OA - asymmetrical OD - diffuse LW - 42°x102° KW - 62°x100°

3626 lm (3000K, CRI 80)

2888 lm (3000K, diffuse, CRI 80)

48 mid-power LEDs
 2-step MacAdam, 50000h L80 B10 (Ta 25°C)

body and cover in anticorrosion aluminium
 screen in grey-serigraphed and transparent, tempered
 extra-clear glass

built in

surface mounted (wall)

indoor version: Berica IN 1.1, p. 613
 single-beam version available on request
 Casambi-compatible version, controllable with
 the Casambi app, available on request

see p. 785

BERICA OUT 1.2

CE ENEC LED TECH IP65 IK07 DALI
 A A+ A++

56W 230Vac
BU1210 ■ ■ **00** ■ ■ **E** White
BU1210 ■ ■ **00** ■ ■ **H** Anthracite
BU1210 ■ ■ **00** ■ ■ **T** Cor-ten
BU1210 ■ ■ **00** ■ ■ **7** Primer

■	0 - CRI 80 1 - CRI >90
■	0 - on/off D - DALI
■	N - 2200K F - 2700K 5 - 3000K 9 - 4000K
■	OA - asymmetrical OD - diffuse LW - 42°x102° KW - 62°x100°

7252 lm (3000K, CRI 80)

5776 lm (3000K, diffuse, CRI 80)

96 mid-power LEDs
 2-step MacAdam, 50000h L80 B10 (Ta 25°C)

body and cover in anticorrosion aluminium
 screen in grey-serigraphed and transparent, tempered
 extra-clear glass

built in

surface mounted (wall)

indoor version: Berica IN 1.2, p. 613
 single-beam version available on request
 Casambi-compatible version, controllable with
 the Casambi app, available on request

see p. 785





^
BERICA OUT
painted primer version

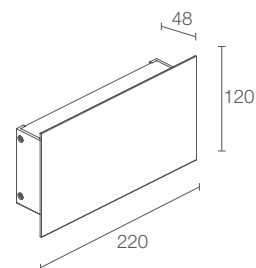

BERICA OUT 2.0



POWER / POWER SUPPLY CODE	15W 230Vac BU2010 000 E White BU2010 000 H Anthracite BU2010 000 T Cor-ten BU2010 000 7 Primer
CRI	0 - CRI 80 1 - CRI >90
CONTROL SYSTEM	on/off
LED COLOUR	N - 2200K F - 2700K 5 - 3000K 9 - 4000K
OPTICS	OA - asymmetrical OD - diffuse LW - 42°x102° KW - 62°x100°

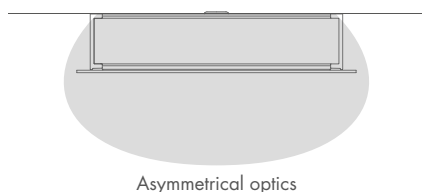

Asymmetrical optics

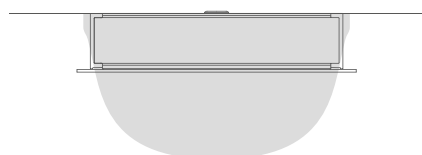

Diffuse optics



42°x102° optics



62°x100° optics

LUMEN OUTPUT AT SOURCE	1814 lm (3000K, CRI 80)
DELIVERED LUMEN OUTPUT	1490 lm (3000K, diffuse, CRI 80)
NO. AND TYPE OF LED	24 mid-power LEDs 2-step MacAdam, 50000h L80 B10 (Ta 25°C)
MATERIAL	body and cover in anticorrosion aluminium screen in grey-serigraphed and transparent, tempered extra-clear glass
POWER SUPPLY UNIT	built in
MOUNTING	surface mounted (wall)
NOTES	indoor version: Berica IN 2.0, p. 614 single-beam version available on request Casambi-compatible version, controllable with the Casambi app, available on request
PHOTOMETRIC DATA	see p. 786

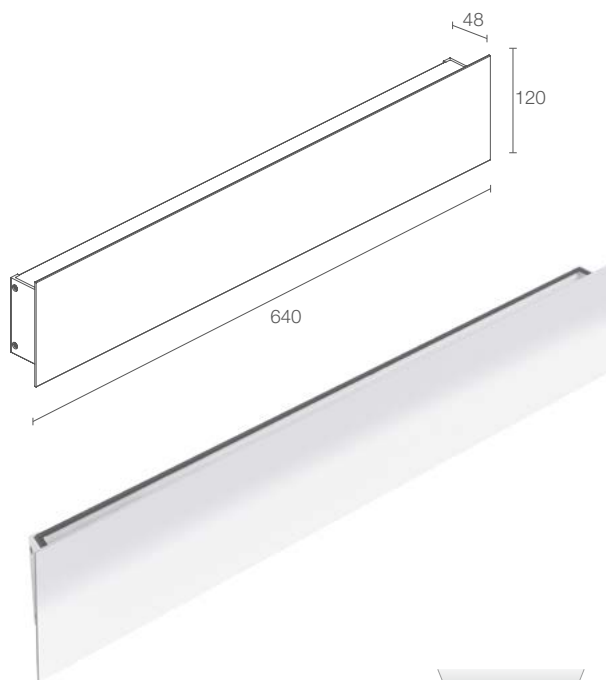
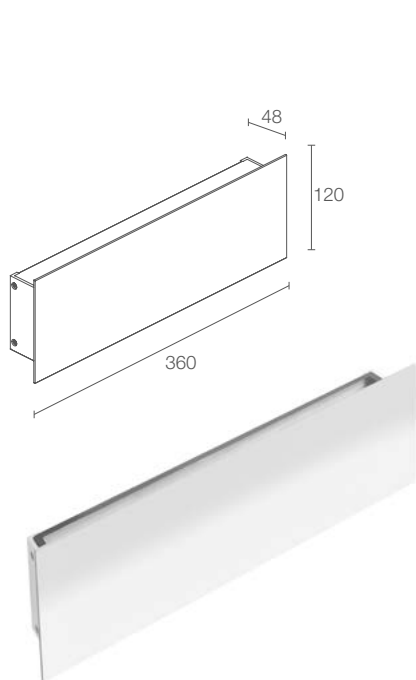

BERICA OUT 2.1

BERICA OUT 2.2

CE ENEC LED TECH IP65 IK07 DALI
 A A+ A++

CE ENEC LED TECH IP65 IK07 DALI
 A A+ A++

30W 230Vac

BU2110 ■ ■ **00** ■ ■ **E** White
BU2110 ■ ■ **00** ■ ■ **H** Anthracite
BU2110 ■ ■ **00** ■ ■ **T** Cor-ten
BU2110 ■ ■ **00** ■ ■ **7** Primer

56W 230Vac

BU2210 ■ ■ **00** ■ ■ **E** White
BU2210 ■ ■ **00** ■ ■ **H** Anthracite
BU2210 ■ ■ **00** ■ ■ **T** Cor-ten
BU2210 ■ ■ **00** ■ ■ **7** Primer

■	0 - CRI 80 1 - CRI >90
■	0 - on/off D - DALI
■	N - 2200K F - 2700K 5 - 3000K 9 - 4000K
■	OA - asymmetrical OD - diffuse LW - 42°x102° KW - 62°x100°

■	0 - CRI 80 1 - CRI >90
■	0 - on/off D - DALI
■	N - 2200K F - 2700K 5 - 3000K 9 - 4000K
■	OA - asymmetrical OD - diffuse LW - 42°x102° KW - 62°x100°

3626 lm (3000K, CRI 80)

2980 lm (3000K, diffuse, CRI 80)

48 mid-power LEDs
 2-step MacAdam, 50000h L80 B10 (Ta 25°C)

body and cover in anticorrosion aluminium
 screen in grey-serigraphed and transparent, tempered
 extra-clear glass

built in

surface mounted (wall)

indoor version: Berica IN 2.1, p. 615
 single-beam version available on request
 Casambi-compatible version, controllable with
 the Casambi app, available on request

see p. 786

7252 lm (3000K, CRI 80)

5960 lm (3000K, diffuse, CRI 80)

96 mid-power LEDs
 2-step MacAdam, 50000h L80 B10 (Ta 25°C)

body and cover in anticorrosion aluminium
 screen in grey-serigraphed and transparent, tempered
 extra-clear glass

built in

surface mounted (wall)

indoor version: Berica IN 2.2, p. 615
 single-beam version available on request
 Casambi-compatible version, controllable with
 the Casambi app, available on request

see p. 786





^
BERICA OUT 3.1
 2200K, 30W, diffuse, cor-ten

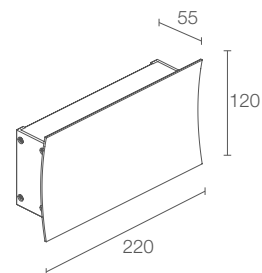

BERICA OUT 3.0

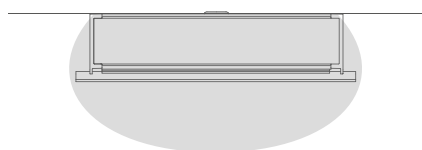

Asymmetrical optics

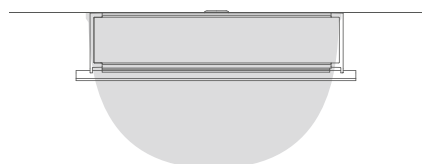

Diffuse optics



42°x102° optics

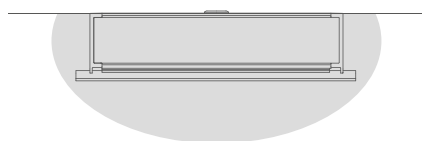

62°x100° optics

POWER / POWER SUPPLY CODE	15W 230Vac
	BU3010 ■ 000 ■ E White
	BU3010 ■ 000 ■ H Anthracite
	BU3010 ■ 000 ■ T Cor-ten
	BU3010 ■ 000 ■ 7 Primer

■ CRI	0 - CRI 80 1 - CRI >90
■ CONTROL SYSTEM	on/off
■ LED COLOUR	N - 2200K F - 2700K 5 - 3000K 9 - 4000K
■ OPTICS	OA - asymmetrical OD - diffuse LW - 42°x102° KW - 62°x100°

LUMEN OUTPUT AT SOURCE	1814 lm (3000K, CRI 80)
DELIVERED LUMEN OUTPUT	1530 lm (3000K, diffuse, CRI 80)
NO. AND TYPE OF LED	24 mid-power LEDs 2-step MacAdam, 50000h L80 B10 (Ta 25°C)
MATERIAL	body and cover in anticorrosion aluminium screen in grey-serigraphed and transparent, tempered extra-clear glass
POWER SUPPLY UNIT	built in
MOUNTING	surface mounted (wall)
NOTES	indoor version: Berica IN 3.0, p. 616 single-beam version available on request Casambi-compatible version, controllable with the Casambi app, available on request
PHOTOMETRIC DATA	see p. 787

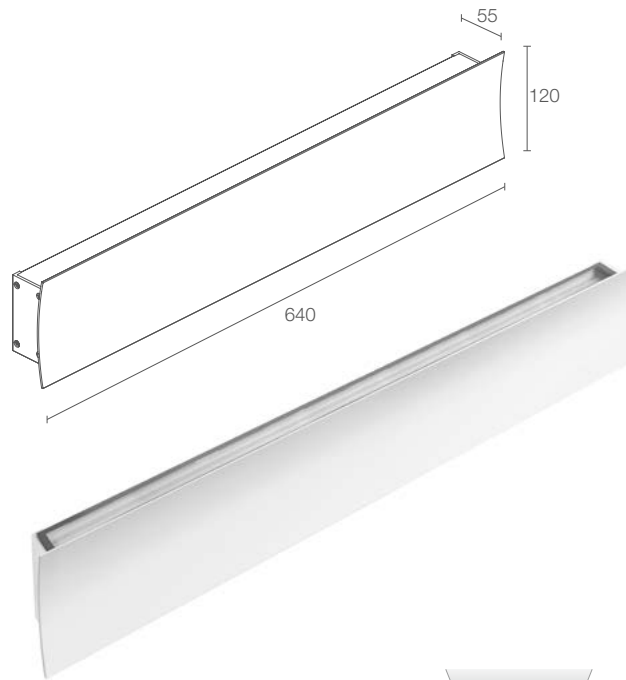
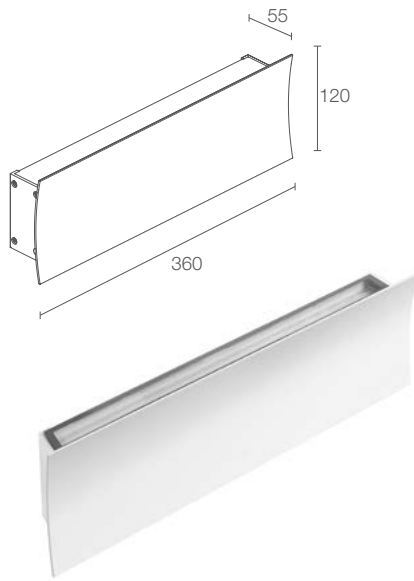

BERICA OUT 3.1

CE ENEC LED TECH IP65 IK07 DALI
 A A+ A++

30W 230Vac
BU3110 ■ ■ **00** ■ ■ **E** White
BU3110 ■ ■ **00** ■ ■ **H** Anthracite
BU3110 ■ ■ **00** ■ ■ **T** Cor-ten
BU3110 ■ ■ **00** ■ ■ **7** Primer

■	0 - CRI 80 1 - CRI >90
■	0 - on/off D - DALI
■	N - 2200K F - 2700K 5 - 3000K 9 - 4000K
■	OA - asymmetrical OD - diffuse LW - 42°x102° KW - 62°x100°

3626 lm (3000K, CRI 80)

3060 lm (3000K, diffuse, CRI 80)

48 mid-power LEDs
 2-step MacAdam, 50000h L80 B10 (Ta 25°C)

body and cover in anticorrosive aluminium
 screen in grey-serigraphed and transparent, tempered
 extra-clear glass

built in

surface mounted (wall)

indoor version: Berica IN 3.1, p. 617
 single-beam version available on request
 Casambi-compatible version, controllable with
 the Casambi app, available on request

see p. 787

BERICA OUT 3.2

CE ENEC LED TECH IP65 IK07 DALI
 A A+ A++

56W 230Vac
BU3210 ■ ■ **00** ■ ■ **E** White
BU3210 ■ ■ **00** ■ ■ **H** Anthracite
BU3210 ■ ■ **00** ■ ■ **T** Cor-ten
BU3210 ■ ■ **00** ■ ■ **7** Primer

■	0 - CRI 80 1 - CRI >90
■	0 - on/off D - DALI
■	N - 2200K F - 2700K 5 - 3000K 9 - 4000K
■	OA - asymmetrical OD - diffuse LW - 42°x102° KW - 62°x100°

7252 lm (3000K, CRI 80)

6120 lm (3000K, diffuse, CRI 80)

96 mid-power LEDs
 2-step MacAdam, 50000h L80 B10 (Ta 25°C)

body and cover in anticorrosive aluminium
 screen in grey-serigraphed and transparent, tempered
 extra-clear glass

built in

surface mounted (wall)

indoor version: Berica IN 3.2, p. 617
 single-beam version available on request
 Casambi-compatible version, controllable with
 the Casambi app, available on request

see p. 787





OUTDOOR WALL MOUNTED WITH SINGLE BEAM, DOUBLE BEAM OR SPEAKER



RESIDENTIAL

HOSPITALITY

HOSPITALITY

URBAN LIGHTING

OUTDOOR WALL MOUNTED



INTONO 1.1 p. 329
3W 24Vdc



INTONO 2.1 p. 331
6W 230Vac
ON/OFF



INTONO 3.1 p. 332
10W 230Vac
ON/OFF, 0/1-10V



INTONO 4.1 p. 334
19W 230Vac
ON/OFF, 0/1-10V



INTONO 1.2 p. 329
6W 24Vdc



INTONO 2.2 p. 331
12W 230Vac
ON/OFF



INTONO 3.2 p. 333
20W 230Vac
ON/OFF, 0/1-10V



INTONO 4.2 p. 335
38W 230Vac
ON/OFF, 0/1-10V



INTONO 3.9 p. 333
9W 24Vdc



INTONO 4.9 p. 335
17W 24Vdc

OUTDOOR CEILING MOUNTED

INTONO C OUT p. 374

INDOOR CEILING MOUNTED

INTONO C IN p. 644



SS
15°+15°



MM
20°+20°



LL
43°+43°



SL
15°+43°



WW
wall grazing
+ wall grazing



WA
wall grazing
+ asymmetrical



ZW
17° sharp
+ wall grazing



IP65
SUITABLE FOR OUTDOOR APPLICATIONS



COMMUNICATES WITH SMART SPEAKERS SUCH AS GOOGLE HOME OR AMAZON ECHO OVER WI-FI USING THE ZIGBEE PROTOCOL, WITH QUICK VOICE COMMANDS – AVAILABLE ON REQUEST



INTONO 3.9 / 4.9
CONTAIN A SPEAKER THAT CAN PLAY YOUR PLAYLISTS FROM SPOTIFY OR AMAZON MUSIC



6-STEP MATERIAL PROTECTION, AND OXIDATION AND CORROSION RESISTANCE

EN AB 46100 low-copper-content aluminium alloy
Preparation for painting
Epoxy paint
Polyester paint
Paints compliant with Qualicoat automotive coating standard
Salt spray tested (over 1500 hours)



IK04 (INTONO 1)



IK06 (INTONO 2 / 3 / 4)
SCREEN IN TRANSPARENT EXTRA-CLEAR GLASS WITH VITRIFIED BLACK SERIGRAPHY, UP TO 4 MM THICK, HIGH TRANSMITTANCE TO ENSURE CHROMATIC UNIFORMITY OF LIGHT AND TEMPERED FOR EXCELLENT RESISTANCE TO KNOCKS AND SCRATCHES

BODY IN DIE-CAST LOW-COPPER-CONTENT ALUMINIUM EN AB 46100, FOR EXCELLENT RESISTENCE TO CORROSION

OUTDOOR CEILING-MOUNTED VERSION: INTONO C OUT, P. 374
INDOOR CEILING-MOUNTED VERSION: INTONO C IN, P. 644

UNIQUE SELLING POINTS



ON REQUEST:
RAL FINISH



COR-TEN



WHITE



GREY



ANTHRACITE



INTONO 3.1
3000K, 10W,
ASYMMETRICAL
OPTICS



THE VERSION COVERED
IN A NEUTRAL,
BONDING PRIMER
ALLOWS THE SURFACE
TO BE PAINTED WITH
THE SAME WALL PAINT
AS THE WALL IT'S ON,
FOCUSING ATTENTION
ON THE LIGHT
OUTPUT ALONE



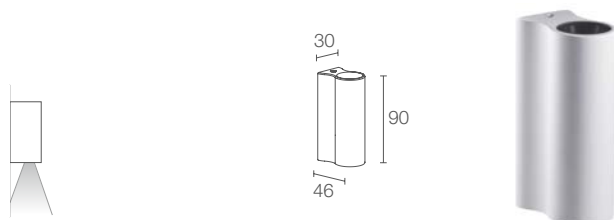

INTONO 1.1

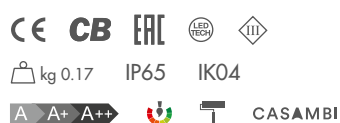

POWER / POWER SUPPLY CODE	3W 24Vdc
	NT1100 00 0 E White
	NT1100 00 0 F Grey
	NT1100 00 0 H Anthracite
	NT1100 00 0 T Cor-ten
NT1100 00 0 7 Primer	

CRI	0 - CRI 80 1 - CRI >90
HONEYCOMB LOUVRE	0 - not present 1 - present
LED COLOUR	F - 2700K 5 - 3000K 9 - 4000K
OPTICS	S - 13° M - 22° L - 33°

LUMEN OUTPUT AT SOURCE	168 lm (3000K, CRI 80)
DELIVERED LUMEN OUTPUT	146 lm (3000K, 22°, CRI 80)
NO. AND TYPE OF LED	1 power LED 1/4 ANSI BIN, 50000h L90 B10 (Ta 25°C)
MATERIAL	body in die-cast aluminium screen in black-serigraphed and transparent, tempered extra-clear glass
POWER SUPPLY UNIT	not included, see p. 904
MOUNTING	surface mounted (wall)
NOTES	ceiling-mounted version: Intono C OUT, p. 374 version compatible with Google Home or Amazon Echo available on request for voice command control
PHOTOMETRIC DATA	see p. 837

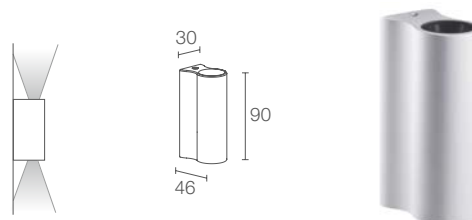

INTONO 1.2

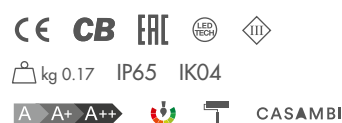

POWER / POWER SUPPLY CODE	6W 24Vdc
	NT1200 00 0 E White
	NT1200 00 0 F Grey
	NT1200 00 0 H Anthracite
	NT1200 00 0 T Cor-ten
NT1200 00 0 7 Primer	

CRI	0 - CRI 80 1 - CRI >90
HONEYCOMB LOUVRE	0 - not present 1 - present
LED COLOUR	F - 2700K 5 - 3000K 9 - 4000K
OPTICS	SS - 13°+13° MM - 22°+22° LL - 33°+33° SL - 13°+33°

LUMEN OUTPUT AT SOURCE	336 lm (3000K, CRI 80)
DELIVERED LUMEN OUTPUT	292 lm (3000K, 22°, CRI 80)
NO. AND TYPE OF LED	2 power LEDs 1/4 ANSI BIN, 50000h L90 B10 (Ta 25°C)
MATERIAL	body in die-cast aluminium screen in black-serigraphed and transparent, tempered extra-clear glass
POWER SUPPLY UNIT	not included, see p. 904
MOUNTING	surface mounted (wall)
NOTES	ceiling-mounted version: Intono C OUT, p. 374 version compatible with Google Home or Amazon Echo available on request for voice command control
PHOTOMETRIC DATA	see p. 837





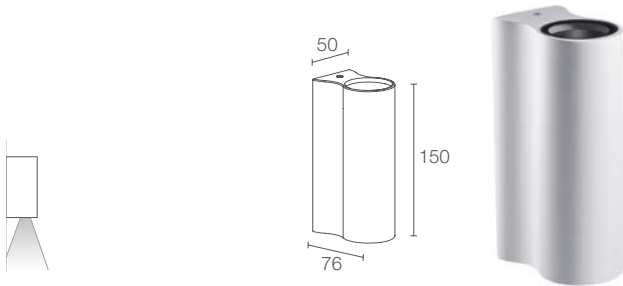

INTONO 2.1



kg 0.63 IP65 IK06



POWER / POWER SUPPLY CODE

6W 230Vac
NT2110 00 0 E White
NT2110 00 0 F Grey
NT2110 00 0 H Anthracite
NT2110 00 0 T Cor-ten
NT2110 00 0 7 Primer

CRI	0 - CRI 80 1 - CRI >90
HONEYCOMB LOUVRE	0 - not present 1 - present (not compatible with 8° asymmetrical and diffuse optics)
LED COLOUR	F - 2700K 5 - 3000K 9 - 4000K
OPTICS	Z - asymmetrical, 8° T - 11° M - 34° K - 68° D - diffuse

LUMEN OUTPUT AT SOURCE	488 lm (3000K, CRI 80)
DELIVERED LUMEN OUTPUT	352 lm (3000K, 34°, CRI 80)
NO. AND TYPE OF LED	1 power LED 3-step MacAdam, 50000h L90 B10 (Ta 25°C)
MATERIAL	body in die-cast aluminium screen in black-serigraphed and transparent, tempered extra-clear glass
POWER SUPPLY UNIT	built in
MOUNTING	surface mounted (wall)
NOTES	ceiling-mounted version: Intono C OUT 2.4, p. 376 version compatible with Google Home or Amazon Echo available on request for voice command control Casambi-compatible version, controllable with the Casambi app, available on request
PHOTOMETRIC DATA	see p. 837

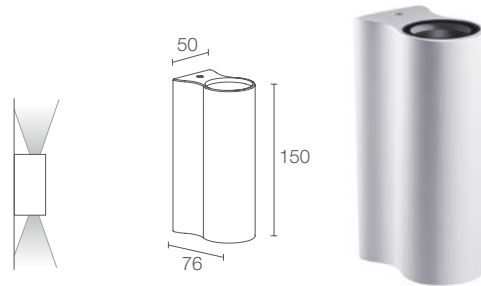

INTONO 2.2



kg 0.63 IP65 IK06



12W 230Vac
NT2210 00 0 E White
NT2210 00 0 F Grey
NT2210 00 0 H Anthracite
NT2210 00 0 T Cor-ten
NT2210 00 0 7 Primer

CRI	0 - CRI 80 1 - CRI >90
HONEYCOMB LOUVRE	0 - not present 1 - present (not compatible with diffuse+diffuse and asymmetrical 8°+68° versions)
LED COLOUR	F - 2700K 5 - 3000K 9 - 4000K
OPTICS	TT - 11°+ 11° TK - 11°+ 68° MM - 34°+ 34° KK - 68°+ 68° DD - diffuse + diffuse ZK - asymmetrical, 8°+ 68°

LUMEN OUTPUT AT SOURCE	976 lm (3000K, CRI 80)
DELIVERED LUMEN OUTPUT	704 lm (3000K, 34°, CRI 80)
NO. AND TYPE OF LED	2 power LEDs 3-step MacAdam, 50000h L90 B10 (Ta 25°C)
MATERIAL	body in die-cast aluminium screen in black-serigraphed and transparent, tempered extra-clear glass
POWER SUPPLY UNIT	built in
MOUNTING	surface mounted (wall)
NOTES	ceiling-mounted version: Intono C OUT 2.4, p. 376 version compatible with Google Home or Amazon Echo available on request for voice command control Casambi-compatible version, controllable with the Casambi app, available on request
PHOTOMETRIC DATA	see p. 837



< INTONO 2.1

3000K, 6W, 11°, white

Project by / Saraiva+Associados

Lighting planning by / Astratec

Photo by / Nicole Sánchez

The Editory Riverside Santa Apolónia Hotel, Lisbon, Portugal

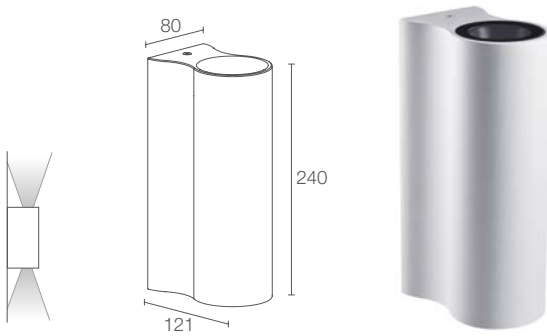

INTONO 3.2

CE CB EAC LED TECH IP65 IK06
A A+ A++

20W 230Vac

NT3210 **0** **1** **5** **9** **SS** **MM** **LL** **SL** **WW** **WA** **ZW** **E** White
F Grey
H Anthracite
T Cor-ten
7 Primer

0 - CRI 80
1 - CRI >90

0 - on/off
R - 0/1-10V
 DALI on request

0 - not present
1 - present
 (not compatible with wall-grazing+wall-grazing,
 wall-grazing+asymmetrical,
 and 17° sharp+wall-grazing versions)

F - 2700K
5 - 3000K
9 - 4000K

SS - 15°+ 15°
MM - 20°+ 20°
LL - 43°+ 43°
SL - 15°+ 43°
WW - wall grazing + wall grazing
WA - wall grazing + asymmetrical
ZW - 17° sharp + wall grazing

1976 lm (3000K, CRI 80)

1674 lm (3000K, 15°, CRI 80)

2 high power density COB LEDs
 2-step MacAdam, 50000h L95 B10 (Ta 25°C)

body in die-cast aluminium
 screen in black-serigraphed and
 transparent, tempered extra-clear glass

built in

surface mounted (wall)

none

ceiling-mounted version: Intono C OUT 3.4, p. 377
 version compatible with Google Home or Amazon Echo
 available on request for voice command control
 Casambi-compatible version, controllable with the
 Casambi app, available on request

see p. 838

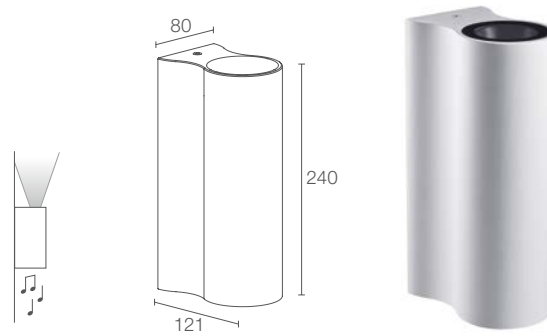

INTONO 3.9

CE EAC LED TECH IP65 IK06
A A+ A++

9W 24Vdc

NT3900 **00** **01** **05** **09** **S** **Z** **M** **L** **W** **A** **9 E** White
9 F Grey
9 H Anthracite
9 T Cor-ten
9 7 Primer

0 - CRI 80
1 - CRI >90

0 - not present
1 - present
 (not compatible with asymmetrical,
 17° sharp and wall-grazing optics)

F - 2700K
5 - 3000K
9 - 4000K

S - 15°
Z - 17° sharp
M - 20°
L - 43°
W - wall grazing
A - asymmetrical

988 lm (3000K, CRI 80)

837 lm (3000K, 15°, CRI 80)

1 high power density COB LED
 2-step MacAdam, 50000h L95 B10 (Ta 25°C)

body in die-cast aluminium
 screen in black-serigraphed and
 transparent, tempered extra-clear glass

not included, see p. 904

surface mounted (wall)

WUNT39A00 Bluetooth 3.0 audio control kit with
 power supply unit and amplifier (for Alexa or
 Google voice-control systems);
WUNT39A01 Wi-Fi control kit

ceiling-mounted version: Intono C OUT 3.9, p. 377
 version compatible with Google Home or Amazon Echo
 available on request for voice command control
 Casambi-compatible version, controllable with the
 Casambi app, available on request

see p. 838





INTONO 4.9

speaker:
maximum power
nominal impedance Z
mean sound pressure level

3W
8 Ohm
86 dB (1W/1m)



INTONO 4.1



CE CB EAC LED TECH IP65 IK06
A A+ A++ 0/1-10V

POWER / POWER SUPPLY CODE

19W 230Vac
NT4110 0 0 0 0 **E** White
NT4110 0 0 0 0 **F** Grey
NT4110 0 0 0 0 **H** Anthracite
NT4110 0 0 0 0 **T** Cor-ten
NT4110 0 0 0 0 **7** Primer

CRI	0 - CRI 80 1 - CRI >90
CONTROL SYSTEM	0 - on/off R - 0/1-10V DALI on request
HONEYCOMB LOUVRE	0 - not present 1 - present (not compatible with asymmetrical, 12° sharp and wall-grazing optics)
LED COLOUR	F - 2700K 5 - 3000K 9 - 4000K
OPTICS	S - 12° Z - 12° sharp M - 23° L - 57° W - wall grazing A - asymmetrical

LUMEN OUTPUT AT SOURCE	1646 lm (3000K, CRI 80)
DELIVERED LUMEN OUTPUT	1386 lm (3000K, 12°, CRI 80)
NO. AND TYPE OF LED	1 high power density COB LED 2-step MacAdam, 50000h L95 B10 (Ta 25°C)
MATERIAL	body in die-cast aluminium screen in black-serigraphed and transparent, tempered extra-clear glass
POWER SUPPLY UNIT	built in
MOUNTING	surface mounted (wall)
ACCESSORIES	none
NOTES	ceiling-mounted version: Intono C OUT p. 374 version compatible with Google Home or Amazon Echo available on request for voice command control Casambi-compatible version, controllable with the Casambi app, available on request
PHOTOMETRIC DATA	see p. 838



INTONO 4.2

CE CB ENEC LED TECH kg 4.80 IP65 IK06
 A A+ A++ 0/1-10V

38W 230Vac

NT4210 **O** **E** White
NT4210 **O** **F** Grey
NT4210 **O** **H** Anthracite
NT4210 **O** **T** Cor-ten
NT4210 **O** **7** Primer

■	0 - CRI 80 1 - CRI >90
■	0 - on/off R - 0/1-10V DALI on request
■	0 - not present 1 - present (not compatible with wall-grazing+wall-grazing, wall-grazing+asymmetrical, and 12° sharp+57° versions)
■	F - 2700K 5 - 3000K 9 - 4000K
■	SS - 12°+ 12° MM - 23°+ 23° LL - 57°+ 57° SL - 12°+ 57° WW - wall grazing + wall grazing WA - wall grazing + asymmetrical ZL - 12° sharp + 57°

3292 lm (3000K, CRI 80)

2772 lm (3000K, 12°, CRI 80)

2 high power density COB LEDs
 2-step MacAdam, 50000h L95 B10 (Ta 25°C)

body in die-cast aluminium
 screen in black-serigraphed and
 transparent, tempered extra-clear glass

built in

surface mounted (wall)

none

ceiling-mounted version: Intono C OUT p. 374
 version compatible with Google Home or Amazon Echo
 available on request for voice command control
 Casambi-compatible version, controllable with the
 Casambi app, available on request

see p. 838

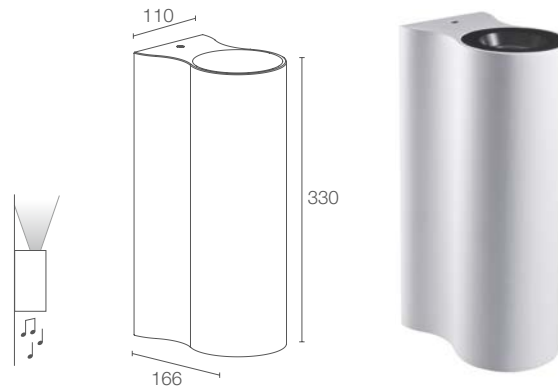

INTONO 4.9

CE ENEC LED TECH kg 4.84 IP65 IK06
 A A+ A++

17W 24Vdc

NT4900 **00** **9 E** White
NT4900 **00** **9 F** Grey
NT4900 **00** **9 H** Anthracite
NT4900 **00** **9 T** Cor-ten
NT4900 **00** **9 7** Primer

■	0 - CRI 80 1 - CRI >90
■	0 - not present 1 - present (not compatible with asymmetrical, 12° sharp and wall-grazing optics)
■	F - 2700K 5 - 3000K 9 - 4000K
■	S - 12° Z - 12° sharp M - 23° L - 57° W - wall grazing A - asymmetrical

1646 lm (3000K, CRI 80)

1386 lm (3000K, 12°, CRI 80)

1 high power density COB LED
 2-step MacAdam, 50000h L95 B10 (Ta 25°C)

body in die-cast aluminium
 screen in black-serigraphed and
 transparent, tempered extra-clear glass

not included, see p. 904

surface mounted (wall)

WUNT39A00 Bluetooth 3.0 audio control kit with
 power supply unit and amplifier (for Alexa or
 Google voice-control systems);
WUNT39A01 Wi-Fi control kit

ceiling-mounted version: Intono C OUT p. 374
 version compatible with Google Home or Amazon Echo
 available on request for voice command control
 Casambi-compatible version, controllable with the
 Casambi app, available on request

see p. 838





OUTDOOR WALL-MOUNTED FIXTURES WITH SINGLE- OR DOUBLE-BEAM OPTICS



SINGLE BEAM



DOUBLE BEAM

2700K 3000K 4000K



diffuse



GEKO 5.0 p. 338
10W/16W 230Vac



GEKO 6.0 p. 339
16W/28W 230Vac

2700K 3000K 4000K 5000K



ultra-narrow



narrow



medium



wide



elliptical



asymmetrical



GEKO 5.1 p. 338
10W 230Vac



GEKO 6.1 p. 339
20W 230Vac

< **GEKO 5.1**
3000K, 10W, 30°, grey
Light planning by / Cristian Turra
Photo by / Alessio Tamborini
Private residence, Brescia, Italy

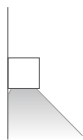
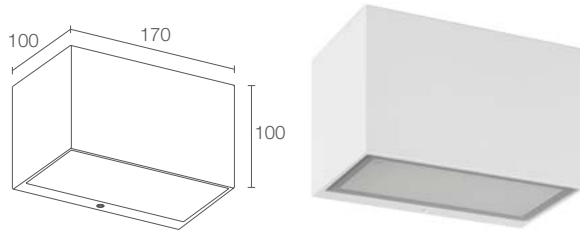
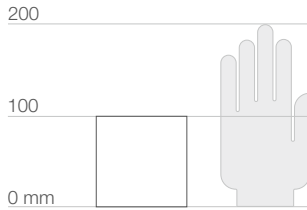

Diffuse

GEKO 5.0

CE EAC LED TECH kg 1.80 IP65 IK07
 A A+ A++

POWER / POWER SUPPLY CODE

10W 230Vac
GK5010 **D E** White
GK5010 **D F** Grey
GK5010 **D H** Anthracite
GK5010 **D T** Cor-ten

16W 230Vac
GK5011 **D E** White
GK5011 **D F** Grey
GK5011 **D H** Anthracite
GK5011 **D T** Cor-ten

LED COLOUR

F - 2700K
5 - 3000K
9 - 4000K

OPTICS

diffuse

LUMEN OUTPUT AT SOURCE 713 lm (3000K, 10W)
 1120 lm (3000K, 16W)

DELIVERED LUMEN OUTPUT 531 lm (3000K, 10W)
 831 lm (3000K, 16W)

NO. AND TYPE OF LED power LED matrix
 3-step MacAdam, 50000h L80 B10 (Ta 25°C)

MATERIAL body in die-cast aluminium
 screen in serigraphed, sandblasted,
 tempered extra-clear glass

POWER SUPPLY UNIT built in

POWER CABLES connection box with 0.30 m cable

MOUNTING surface mounted (wall)

ACCESSORIES see p. 341

NOTES spacer with RAL finish available on request
 Casambi-compatible version, controllable with
 the Casambi app, available on request

PHOTOMETRIC DATA see p. 830

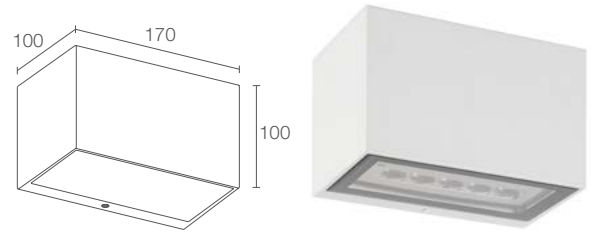

Optics

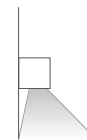

Asymmetrical optics

GEKO 5.1

CE EAC LED TECH kg 1.80 IP65 IK07
 A A+ A++ PID

10W 230Vac
GK5110 **E** White
GK5110 **F** Grey
GK5110 **H** Anthracite
GK5110 **T** Cor-ten

F - 2700K
5 - 3000K
9 - 4000K
0 - 5000K

T - 7°
S - 10°
F - 30°
K - 70°
W - 10°x45°
A - asymmetrical

727 lm (3000K)

535 lm (3000K, 30°)

5 power LEDs
 1/4 ANSI BIN, 50000h L90 B10 (Ta 25°C)

body in die-cast aluminium
 screen in serigraphed and transparent,
 tempered extra-clear glass

built in

connection box with 0.30 m cable

surface mounted (wall)

see p. 341

spacer with RAL finish available on request
 Casambi-compatible version, controllable with
 the Casambi app, available on request

see p. 830

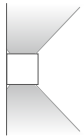
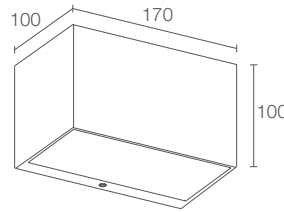
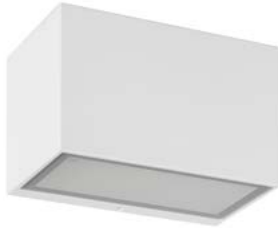
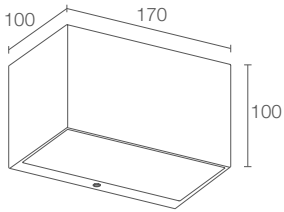

Diffuse

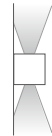

Optics



Asymmetrical optics

GEKO 6.0

CE ENEC LED TPC kg 2.20 IP65 IK07
A A+ A++

16W 230Vac
GK6010 **D E** White
GK6010 **D F** Grey
GK6010 **D H** Anthracite
GK6010 **D T** Cor-ten

28W 230Vac
GK6011 **D E** White
GK6011 **D F** Grey
GK6011 **D H** Anthracite
GK6011 **D T** Cor-ten

F - 2700K
5 - 3000K
9 - 4000K

diffuse

GEKO 6.1

CE ENEC LED TPC kg 2.20 IP65 IK07
A A+ A++ PID

20W 230Vac
GK6110 **E** White
GK6110 **F** Grey
GK6110 **H** Anthracite
GK6110 **T** Cor-ten

F - 2700K
5 - 3000K
9 - 4000K
0 - 5000K

T - 7°
S - 10°
F - 30°
K - 70°
W - 10°x45°
A - asymmetrical

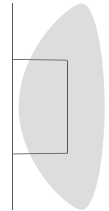

Asymmetrical optics
(Geko 5.1 / 6.1)

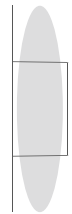

10°x45° optics
(Geko 5.1 / 6.1)

1426 lm (3000K, 16W)
 2240 lm (3000K, 28W)

1062 lm (3000K, 16W)
 1662 lm (3000K, 28W)

power LED matrix
 3-step MacAdam, 50000h L80 B10 (Ta 25°C)

body in die-cast aluminium
 screen in serigraphed, sandblasted,
 tempered extra-clear glass

built in

connection box with 0.30 m cable

surface mounted (wall)

see p. 341

spacer with RAL finish available on request
 Casambi-compatible version, controllable with
 the Casambi app, available on request

see p. 830

1454 lm (3000K)

1070 lm (3000K, 30°)

10 power LEDs
 1/4 ANSI BIN, 50000h L90 B10 (Ta 25°C)

body in die-cast aluminium
 screen in serigraphed and transparent,
 tempered extra-clear glass

built in

connection box with 0.30 m cable

surface mounted (wall)

see p. 341

spacer with RAL finish available on request
 Casambi-compatible version, controllable with
 the Casambi app, available on request

see p. 830





ACCESSORIES

ACCESSORIES FOR INSTALLATION

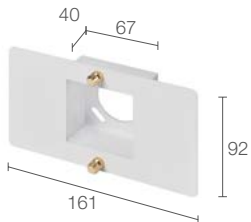

- WD0300E** - White
 - WD0300F** - Grey
 - WD0300H** - Anthracite
 - WD0300T** - Corten
- Spacer
RAL finish available on request

< **GEKO 5.1**
3000K, asymmetrical optics, customized version
with 13W power and red RAL finish
Photo by / Saverio Lombardi Vallauri
Basilica of Sant'Ambrogio, Milan, Italy

∨
GEKO 5.1
with asymmetrical optics



∨
GEKO 5.1
with 70° optics





342

L&L Luce&Light

OUTDOOR WALL-MOUNTED FIXTURES WITH DIFFERENT OUTPUTS

2700K 3000K 4000K

HEIGHT 100 mm

HEIGHT 150 mm



KOCCA 1.1 p. 344
4W/8.5W 230Vac



diffuse asymmetrical



KOCCA 3.1 p. 346
12W/18W 230Vac

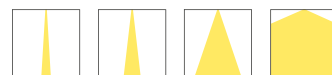

ultra-narrow narrow medium diffuse



KOCCA 1.2 p. 344
7W/15W 230Vac



diffuse asymmetrical



KOCCA 3.2 p. 347
15W/21W/36W 230Vac



ultra-narrow narrow medium diffuse

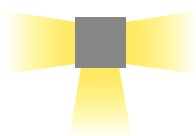

KOCCA 1.3 p. 345
10W 230Vac



asymmetrical

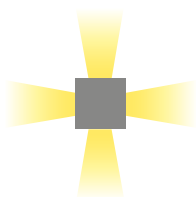

KOCCA 1.4 p. 345
13W 230Vac



asymmetrical



KOCCA 3.4 p. 347
30W/40W 230Vac

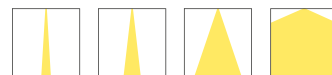

ultra-narrow narrow medium diffuse

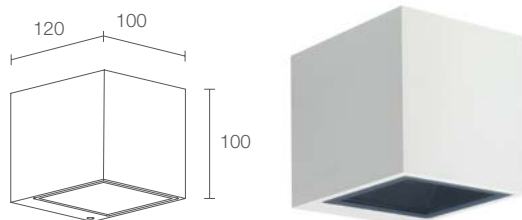
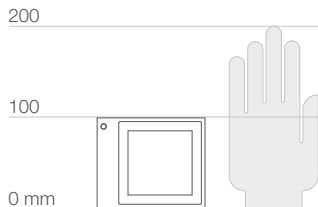

KOCCA 1.1



CE CB ENEC LED TECH kg 1.80 IP65 IK07
 A A+ A++ PID

POWER / POWER SUPPLY CODE

4W 230Vac optics version
KA1110 E White
KA1110 F Grey
KA1110 H Anthracite
KA1110 T Cor-ten

8.5W 230Vac optics version
KA1111 E White
KA1111 F Grey
KA1111 H Anthracite
KA1111 T Cor-ten

8.5W 230Vac diffuse
KA1111 DE White
KA1111 DF Grey
KA1111 DH Anthracite
KA1111 DT Cor-ten

LED COLOUR

F - 2700K
5 - 3000K
9 - 4000K

OPTICS

W - asymmetrical, 10°
K - asymmetrical, 70° (only 4W version)
A - asymmetrical, 140°

LUMEN OUTPUT AT SOURCE

184 lm (3000K, 4W)
 657 lm (3000K, 8.5W)

DELIVERED LUMEN OUTPUT

102 lm (3000K, 140° asymmetrical, 4W)
 323 lm (3000K, 140° asymmetrical, 8.5W)
 478 lm (3000K, diffuse optics)

NO. AND TYPE OF LED

1 power LED, 1/4 ANSI BIN (4W version)
 1 high-intensity power LED
 3-step MacAdam (8.5W version)
 50000h L90 B10 (Ta 25°C)

MATERIAL

body in die-cast aluminium
 screen in serigraphed and transparent, tempered extra-clear glass (optics version)
 screen in serigraphed, tempered extra-clear glass and opal PMMA (diffuse version)

POWER SUPPLY UNIT

built in

POWER CABLES

connection box with 0.50 m cable
 H05RN-F 2x0.75 Ø6.3 mm

MOUNTING

surface mounted (wall)

NOTES

Casambi-compatible version, controllable with the Casambi app, available on request

PHOTOMETRIC DATA

see p. 840

KOCCA 1.2



CE CB ENEC LED TECH kg 1.66 IP65 IK07
 A A+ A++ PID

7W 230Vac optics version
KA1210 E White
KA1210 F Grey
KA1210 H Anthracite
KA1210 T Cor-ten

15W 230Vac optics version
KA1211 E White
KA1211 F Grey
KA1211 H Anthracite
KA1211 T Cor-ten

15W 230Vac diffuse
KA1211 DE White
KA1211 DF Grey
KA1211 DH Anthracite
KA1211 DT Cor-ten

F - 2700K
5 - 3000K
9 - 4000K

W - asymmetrical, 10°
K - asymmetrical, 70° (only 7W version)
A - asymmetrical, 140°

368 lm (3000K, 7W)
 1314 lm (3000K, 15W)

204 lm (3000K, 140° asymmetrical, 7W)
 646 lm (3000K, 140° asymmetrical, 15W)
 956 lm (3000K, diffuse optics)

2 power LEDs, 1/4 ANSI BIN (7W version)
 2 high-intensity power LEDs
 3-step MacAdam (15W version)
 50000h L90 B10 (Ta 25°C)

body in die-cast aluminium
 screen in serigraphed and transparent, tempered extra-clear glass (optics version)
 screen in serigraphed, tempered extra-clear glass and opal PMMA (diffuse version)

built in

connection box with 0.50 m cable
 H05RN-F 2x0.75 Ø6.3 mm

surface mounted (wall)

Casambi-compatible version, controllable with the Casambi app, available on request

see p. 840

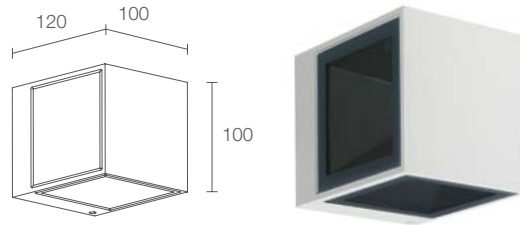
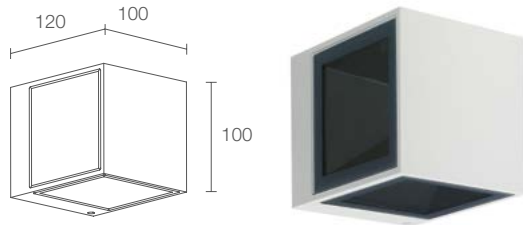

KOCCA 1.3

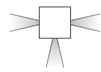

CE CB ENEC LED TECH kg 1.35 IP65 IK07
 A A+ A++ PID

10W 230Vac optics version
KA1310 E White
KA1310 F Grey
KA1310 H Anthracite
KA1310 T Cor-ten

KOCCA 1.4

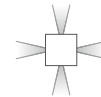

CE CB ENEC LED TECH kg 1.50 IP65 IK07
 A A+ A++ PID

13W 230Vac optics version
KA1410 E White
KA1410 F Grey
KA1410 H Anthracite
KA1410 T Cor-ten

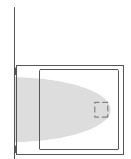

10° asymmetrical optics

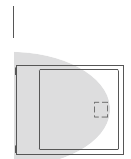

70° asymmetrical optics

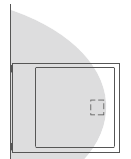

140° asymmetrical optics

■	F - 2700K 5 - 3000K 9 - 4000K
■	W - asymmetrical, 10° K - asymmetrical, 70° A - asymmetrical, 140°

552 lm (3000K)

357 lm (3000K, 70° asymmetrical)

3 power LEDs
 1/4 ANSI BIN, 50000h L90 B10 (Ta 25°C)

body in die-cast aluminium
 screen in serigraphed and transparent, tempered
 extra-clear glass

built in

connection box with 0.50 m cable
 H05RN-F 2x0.75 Ø6.3 mm

surface mounted (wall)

Casambi-compatible version, controllable with
 the Casambi app, available on request

see p. 840

■	F - 2700K 5 - 3000K 9 - 4000K
■	W - asymmetrical, 10° K - asymmetrical, 70° A - asymmetrical, 140°

736 lm (3000K)

476 lm (3000K, 70° asymmetrical)

4 power LEDs
 1/4 ANSI BIN, 50000h L90 B10 (Ta 25°C)

body in die-cast aluminium
 screen in serigraphed and transparent, tempered
 extra-clear glass

built in

connection box with 0.50 m cable
 H05RN-F 2x0.75 Ø6.3 mm

surface mounted (wall)

Casambi-compatible version, controllable with
 the Casambi app, available on request

see p. 840



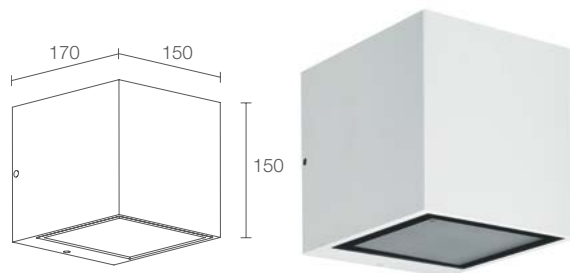
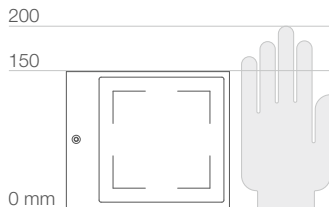

KOCCA 3.1



CE CB EAC kg 3.85 IP65 IK06

POWER / POWER SUPPLY CODE

12W 230Vac diffuse
KA3110 **D E** White
KA3110 **D F** Grey
KA3110 **D H** Anthracite
KA3110 **D T** Cor-ten

12W 230Vac optics version
KA3110 **E** White
KA3110 **F** Grey
KA3110 **H** Anthracite
KA3110 **T** Cor-ten

18W 230Vac optics version
KA3111 **E** White
KA3111 **F** Grey
KA3111 **H** Anthracite
KA3111 **T** Cor-ten

LED COLOUR

F - 2700K
S - 3000K
9 - 4000K

OPTICS

T - 7°
S - 10°
F - 30°

LUMEN OUTPUT AT SOURCE

727 lm (3000K, optics version, 12W)
 1308 lm (3000K, optics version, 18W)
 625 lm (3000K, diffuse version)

DELIVERED LUMEN OUTPUT

631 lm (3000K, 30°, 12W)
 1137 lm (3000K, 30°, 18W)
 441 lm (3000K, diffuse optics)

NO. AND TYPE OF LED

5, 9 power LEDs (optics version)
 power LED matrix (diffuse version)
 1/4 ANSI BIN, 50000h L90 B10 (Ta 25°C)

MATERIAL

body in die-cast aluminium
 screen in serigraphed and transparent, tempered
 extra-clear glass (optics version)
 screen in serigraphed, sandblasted, tempered
 extra-clear glass (diffuse version)

POWER SUPPLY UNIT

built in

POWER CABLES

connection box with 0.50 m cable
 H05RN-F 2x0.75 Ø6.3 mm

MOUNTING

surface mounted (wall)

ACCESSORIES

see p. 349

NOTES

DALI and 0/1-10V versions available on request
 spacer with RAL finish available on request
 Casambi-compatible version, controllable with
 the Casambi app, available on request

PHOTOMETRIC DATA

see p. 840

▼
KOCCA 3.1
 3000K, 18W, 7°, anthracite
TAK 1.1
 3000K, 18W, 70°, anthracite
 Project by / Amatori Architettura d'Interni
 Light planning by / Litek
 Listrop Viaggi & Turismo, Rosà, Vicenza, Italy



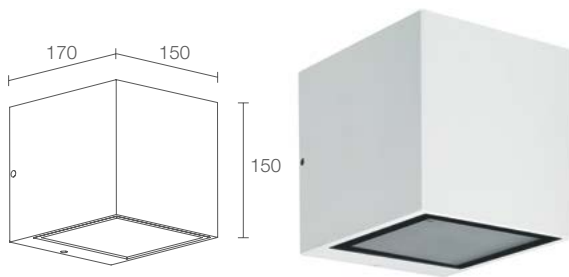

KOCCA 3.2



CE CB ENEC LED TECH kg 4.05 IP65 IK06
 A A+ A++ PID

15W 230Vac diffuse
KA3210 **D E** White
KA3210 **D F** Grey
KA3210 **D H** Anthracite
KA3210 **D T** Cor-ten

21W 230Vac optics version
KA3210 **E** White
KA3210 **F** Grey
KA3210 **H** Anthracite
KA3210 **T** Cor-ten

36W 230Vac optics version
KA3211 **E** White
KA3211 **F** Grey
KA3211 **H** Anthracite
KA3211 **T** Cor-ten

■	F - 2700K S - 3000K 9 - 4000K
■	T - 7° S - 10° F - 30°

1250 lm (3000K, diffuse version)
 1454 lm (3000K, optics version, 21W)
 2616 lm (3000K, optics version, 36W)

1262 lm (3000K, 30°, 21W)
 2274 lm (3000K, 30°, 36W)
 882 lm (3000K, diffuse optics)

10, 18 power LEDs (optics version)
 matrice power LED (diffuse version)
 1/4 ANSI BIN, 50000h L90 B10 (Ta 25°C)

body in die-cast aluminium
 screen in serigraphed and transparent, tempered
 extra-clear glass (optics version)
 screen in serigraphed, sandblasted, tempered
 extra-clear glass (diffuse version)

built in

connection box with 0.50 m cable
 H05RN-F 2x0.75 Ø6.3 mm

surface mounted (wall)

see p. 349

DALI and 0/1-10V versions available on request
 spacer with RAL finish available on request
 Casambi-compatible version, controllable with
 the Casambi app, available on request

see p. 840

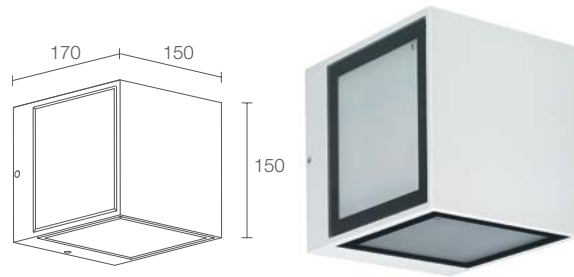

KOCCA 3.4

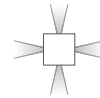

CE CB ENEC LED TECH kg 4.45 IP65 IK06
 A A+ A++ PID

30W 230Vac diffuse
 40W 230Vac optics version
KA3410 **E** White
KA3410 **F** Grey
KA3410 **H** Anthracite
KA3410 **T** Cor-ten

■	F - 2700K S - 3000K 9 - 4000K
■	T - 7° S - 10° F - 30° D - diffuse

2500 lm (3000K, diffuse version)
 2908 lm (3000K, optics version)

1764 lm (3000K, diffuse optics)
 2524 lm (3000K, 30°)

20 power LEDs (optics version)
 power LED matrix (diffuse version)
 1/4 ANSI BIN, 50000h L90 B10 (Ta 25°C)

body in die-cast aluminium
 screen in serigraphed and transparent, tempered
 extra-clear glass (optics version)
 screen in serigraphed, sandblasted, tempered
 extra-clear glass (diffuse version)

built in

connection box with 0.50 m cable
 H05RN-F 2x0.75 Ø6.3 mm

surface mounted (wall)

see p. 349

spacer with RAL finish available on request
 Casambi-compatible version, controllable with
 the Casambi app, available on request

see p. 840





ACCESSORIES

ACCESSORIES FOR INSTALLATION

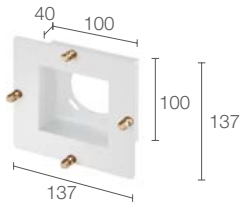

- WD0400E** - White
 - WD0400F** - Grey
 - WD0400H** - Anthracite
 - WD0400T** - Corten
- Spacer
RAL finish available on request
(Kocca 3)

KOCCA 1: INSTALLATION AT A HEIGHT OF 2 METRES

4W - asymmetrical, 10°

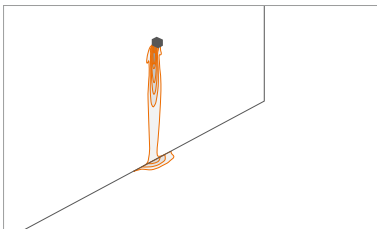

4W - asymmetrical, 70°

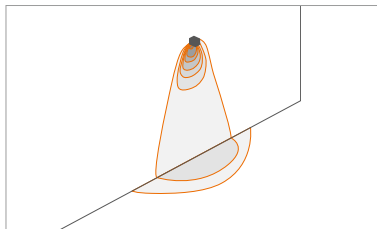

4W - asymmetrical, 140°

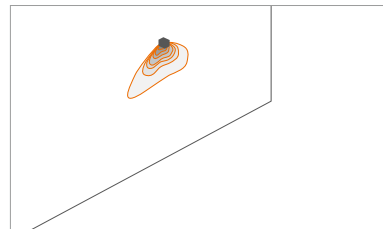

8.5W - asymmetrical, 10°

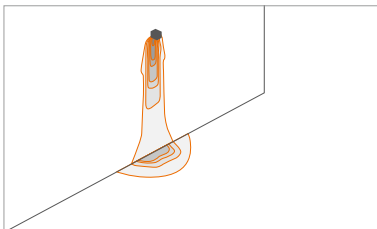

8.5W - asymmetrical, 140°

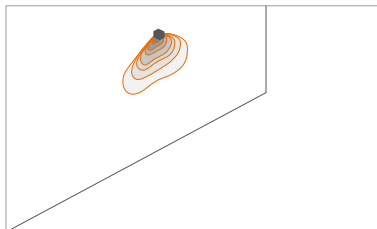

8.5W - diffuse

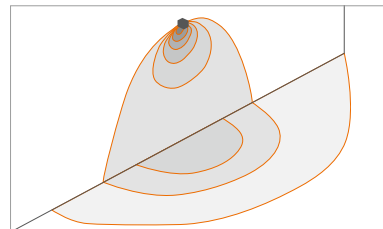



ELLA OUT

OUTDOOR WALL MOUNTED SINGLE BEAM, DIFFUSE LIGHT



diffuse



2700K 3000K 4000K

OUTDOOR

INDOOR

WALL MOUNTED



ELLA OUT 1.0 p. 352
7W 230Vac
493 lm (3000K)



ELLA OUT 2.0 p. 353
16W 230Vac
985 lm (3000K)



ELLA OUT 3.0 p. 353
19W 230Vac
1478 lm (3000K)

ELLA IN p. 622



CEILING MOUNTED **ELLO OUT** p. 380

ELLO IN p. 658



^
ELLA OUT 1.0
 3000K, 7W, diffuse, cor-ten

Project and light planning by / Lorella Marconi,
 Cinzia Todeschini (Lucearchitettura)
 Photo by / Alessio Tamborini
 Magari Estates Hotel
 Colagnola ai Colli, Verona, Italy

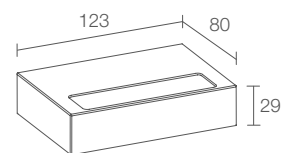

ELLA OUT 1.0

CE ENEC LED TECH kg 0.40 IP65 IK08
 A A+ A++

POWER / POWER SUPPLY CODE	7W 230Vac	
	EA1010 ■ D E T	White
	EA1010 ■ D F T	Grey
	EA1010 ■ D H T	Anthracite
	EA1010 ■ D T T	Cor-ten

■ LED COLOUR	F - 2700K
	5 - 3000K
	9 - 4000K

OPTICS	diffuse
---------------	---------

LUMEN OUTPUT AT SOURCE	954 lm (3000K)
DELIVERED LUMEN OUTPUT	493 lm (3000K)
NO. AND TYPE OF LED	18 mid-power LEDs 3-step MacAdam, 50000h L80 B10 (Ta 25°C)
MATERIAL	body in aluminium screen in serigraphed extra-clear microprismatic glass
POWER SUPPLY UNIT	built in
POWER CABLES	includes 1.5 m neoprene cable H05RN-F 3x1.00 Ø7.0 mm
MOUNTING	surface mounted (wall)
ACCESSORIES	see p. 355
NOTES	indoor version: Ella IN 1.0, p. 624 ceiling-mounted version: Ello OUT 1.0, p. 382 Casambi-compatible version, controllable with the Casambi app, available on request
PHOTOMETRIC DATA	see p. 824

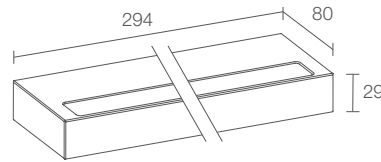
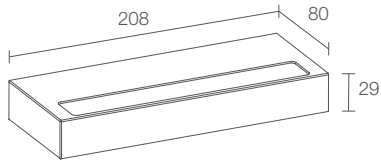

ELLA OUT 2.0



CE EAC LED TEC kg 0.80 IP65 IK08
 A A+ A++

16W 230Vac
EA2010 D E T White
EA2010 D F T Grey
EA2010 D H T Anthracite
EA2010 D T T Cor-ten

F - 2700K
 5 - 3000K
 9 - 4000K

diffuse

1908 lm (3000K)

985 lm (3000K)

36 mid-power LEDs
 3-step MacAdam, 50000h L80 B10 (Ta 25°C)

body in aluminium
 screen in serigraphed extra-clear
 microprismatic glass

built in

includes 1.5 m neoprene cable
 H05RN-F 3x1.00 Ø7.0 mm

surface mounted (wall)

see p. 355

indoor version: Ella IN 2.0, p. 625
 ceiling-mounted version: Ella OUT 2.0, p. 383
 Casambi-compatible version, controllable with
 the Casambi app, available on request

see p. 824

ELLA OUT 3.0



CE EAC LED TEC kg 1.20 IP65 IK08
 A A+ A++

19W 230Vac
EA3010 D E T White
EA3010 D F T Grey
EA3010 D H T Anthracite
EA3010 D T T Cor-ten

F - 2700K
 5 - 3000K
 9 - 4000K

diffuse

2862 lm (3000K)

1478 lm (3000K)

54 mid-power LEDs
 3-step MacAdam, 50000h L80 B10 (Ta 25°C)

body in aluminium
 screen in serigraphed extra-clear
 microprismatic glass

built in

includes 1.5 m neoprene cable
 H05RN-F 3x1.00 Ø7.0 mm

surface mounted (wall)

see p. 355

indoor version: Ella IN 3.0, p. 625
 ceiling-mounted version: Ella OUT 3.0, p. 383
 Casambi-compatible version, controllable with
 the Casambi app, available on request

see p. 824





ACCESSORIES

ACCESSORIES FOR INSTALLATION

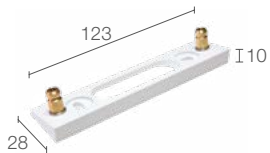

WD0651E - White
WD0651F - Grey
WD0651H - Anthracite
WD0651T - Cor-ten
 Spacer for 15° inclination
 RAL finish available on request
 (Ella OUT 1.0)

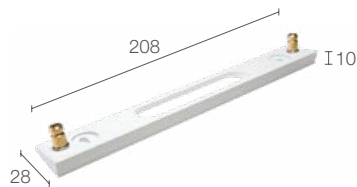

WD0652E - White
WD0652F - Grey
WD0652H - Anthracite
WD0652T - Cor-ten
 Spacer for 15° inclination
 RAL finish available on request
 (Ella OUT 2.0)

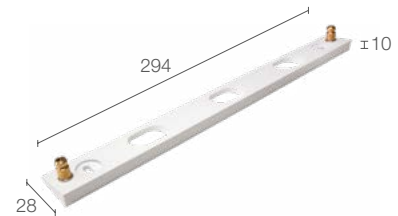

WD0653E - White
WD0653F - Grey
WD0653H - Anthracite
WD0653T - Cor-ten
 Spacer for 15° inclination
 RAL finish available on request
 (Ella OUT 3.0)

STANDARD FINISHES



White



Grey



Anthracite



Cor-ten

< ELLA OUT 2.0

3000K, 16W, diffuse, cor-ten

Project and light planning by / Lorella Marconi,
 Cinzia Todeschini (Lucearchitettura)
 Photo by / Alessio Tamborini
 Magari Estates Hotel
 Colognola ai Colli, Verona, Italy

∨ ELLA OUT 1.0

without spacer



∨ ELLA OUT 1.0

with spacer (15° inclination)





UPDOWN

OUTDOOR WALL MOUNTED WITH VARIOUS BEAMS, AND WHITE AND RGB LIGHT

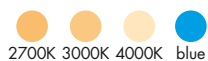
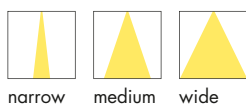

SINGLE BEAM



DOUBLE BEAM



DOUBLE BEAM

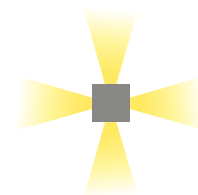

2 / 3 / 4 BEAMS

CONSTANT CURRENT



UPDOWN 3.0

p. 358
max 6W max 500mA
RGB: max 3W max 350mA



UPDOWN 4.0

p. 359
max 6W max 350mA



UPDOWN 6.0

p. 360
max 4W max 500mA



UPDOWN 7.0

p. 361
max 4W/6W/8W max 500mA

CONSTANT VOLTAGE



UPDOWN 3.6

p. 358
6W 24Vdc



UPDOWN 4.6

p. 359
6W 24Vdc

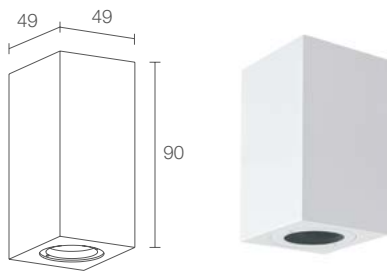
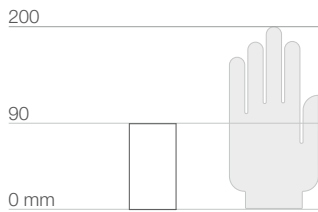

UPDOWN 3.0



POWER / POWER SUPPLY CODE

max 6W max 500mA blue/white light

UD3032 ■ **E** White
UD3032 ■ **A** Anodized grey
UD3032 ■ **H** Anthracite
UD3032 ■ **T** Cor-ten

max 3W max 350mA RGB light

UD3031 6 ■ **E** White
UD3031 6 ■ **A** Anodized grey
UD3031 6 ■ **H** Anthracite
UD3031 6 ■ **T** Cor-ten

LED COLOUR

F - 2700K
5 - 3000K
9 - 4000K
1 - blue

OPTICS

S - 15°
M - 22°
L - 54°

LUMEN OUTPUT AT SOURCE	436 lm (3000K, 500mA) RGB: 160 lm, R: 59 lm G: 76 lm B: 25 lm (350mA)
DELIVERED LUMEN OUTPUT	239 lm (3000K, 500mA, 22°) RGB: 114 lm, R: 42 lm G: 54 lm B: 18 lm (350mA, 22°)
NO. AND TYPE OF LED	3 power LEDs 1/4 ANSI BIN (white LED colour) 50000h L90 B10 (Ta 25°C)
MATERIAL	body in anodized aluminium screen in transparent extra-clear glass
POWER SUPPLY UNIT	not included, see p. 904 and 917
POWER CABLES	includes 0.30 m PVC cable FROR 2x0.35 Ø3.5 mm
WIRING	series
MOUNTING	surface mounted (wall)
ACCESSORIES	see p. 363
NOTES	spacer with RAL finish available on request
PHOTOMETRIC DATA	see p. 898

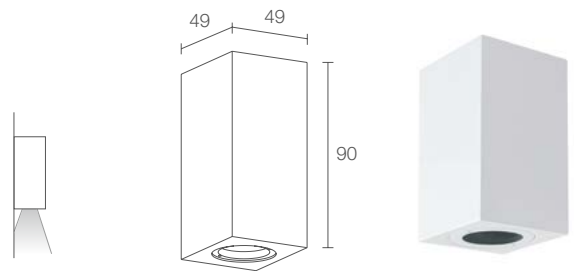

UPDOWN 3.6



6W 24Vdc

UD3600 ■ **E** White
UD3600 ■ **A** Anodized grey
UD3600 ■ **H** Anthracite
UD3600 ■ **T** Cor-ten

F - 2700K
5 - 3000K
9 - 4000K
1 - blue

S - 15°
M - 22°
L - 54°

LUMEN OUTPUT AT SOURCE	436 lm (3000K)
DELIVERED LUMEN OUTPUT	239 lm (3000K, 22°)
NO. AND TYPE OF LED	3 power LEDs 1/4 ANSI BIN (white LED colour) 50000h L90 B10 (Ta 25°C)
MATERIAL	body in anodized aluminium screen in transparent extra-clear glass
POWER SUPPLY UNIT	not included, see p. 904
POWER CABLES	includes 0.30 m PVC cable FROR 2x0.35 Ø3.5 mm
WIRING	parallel
MOUNTING	surface mounted (wall)
ACCESSORIES	see p. 363
NOTES	spacer with RAL finish available on request
PHOTOMETRIC DATA	see p. 898

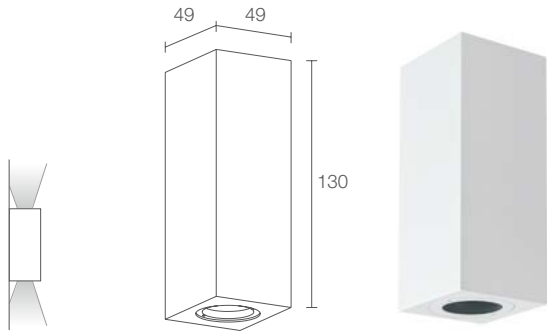
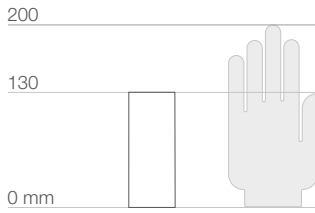

UPDOWN 4.0



max 6W max 350mA
UD4061 ■ ■ ■ **E** White
UD4061 ■ ■ ■ **A** Anodized grey
UD4061 ■ ■ ■ **H** Anthracite
UD4061 ■ ■ ■ **T** Cor-ten

■	F - 2700K 5 - 3000K 9 - 4000K 1 - blue 6 - RGB
■	UP optics: S - 15° M - 22° L - 54°
	DOWN optics: S - 15° M - 22° L - 54°

472 lm (3000K, 350mA),
 RGB: 320 lm, R: 118 lm G: 152 lm B: 50 lm (350mA)

364 lm (3000K, 350mA, 22°),
 RGB: 228 lm, R: 84 lm G: 108 lm B: 36 lm (350mA, 22°)

6 power LEDs
 1/4 ANSI BIN (white LED colour)
 50000h L90 B10 (Ta 25°C)

body in anodized aluminium
 screen in transparent extra-clear glass

not included, see p. 904 and 917

includes 0.30 m PVC cable
 FROR 2x0.35 Ø3.5 mm

series

surface mounted (wall)

see p. 363

spacer with RAL finish available on request

see p. 898

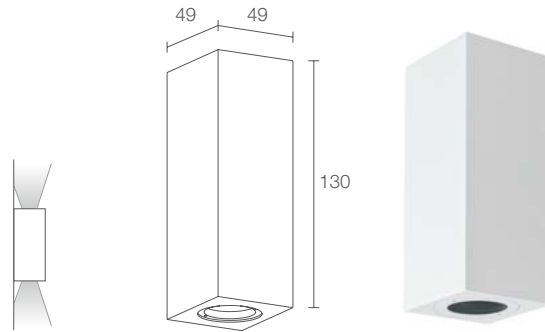

UPDOWN 4.6



6W 24Vdc
UD4600 ■ ■ ■ **E** White
UD4600 ■ ■ ■ **A** Anodized grey
UD4600 ■ ■ ■ **H** Anthracite
UD4600 ■ ■ ■ **T** Cor-ten

■	F - 2700K 5 - 3000K 9 - 4000K 1 - blue
■	UP optics: S - 15° M - 22° L - 54°
	DOWN optics: S - 15° M - 22° L - 54°

472 lm (3000K)

364 lm (3000K, 22°)

6 power LEDs
 1/4 ANSI BIN (white LED colour)
 50000h L90 B10 (Ta 25°C)

body in anodized aluminium
 screen in transparent extra-clear glass

not included, see p. 904

includes 0.30 m PVC cable
 FROR 2x0.35 Ø3.5 mm

parallel

surface mounted (wall)

see p. 363

spacer with RAL finish available on request

see p. 898



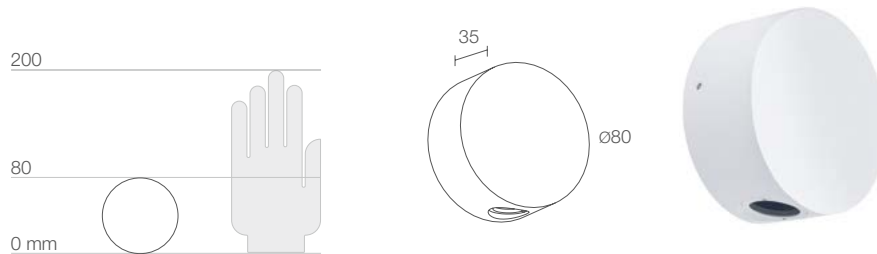

UPDOWN 6.0



POWER / POWER SUPPLY CODE

max 4W max 500mA

UD6022 ■ ■ ■ **E** White
UD6022 ■ ■ ■ **A** Anodized grey
UD6022 ■ ■ ■ **H** Anthracite
UD6022 ■ ■ ■ **T** Cor-ten

LED COLOUR

F - 2700K
5 - 3000K
9 - 4000K
1 - blue

OPTICS

UP optics:	DOWN optics:
S - 10°	S - 10°
M - 20°	M - 20°
L - 40°	L - 40°

LUMEN OUTPUT AT SOURCE 290 lm (3000K, 500mA)

DELIVERED LUMEN OUTPUT 206 lm (3000K, 500mA, 20°)

NO. AND TYPE OF LED 2 power LEDs
 1/4 ANSI BIN (white LED colour)
 50000h L90 B10 (Ta 25°C)

MATERIAL body in anodized aluminium
 screen in transparent, tempered glass

POWER SUPPLY UNIT not included, see p. 904

POWER CABLES includes 0.30 m PVC cable
 FROR 2x0.35 Ø3.5 mm

WIRING series

MOUNTING surface mounted (wall)

PHOTOMETRIC DATA see p. 898

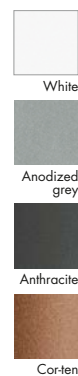

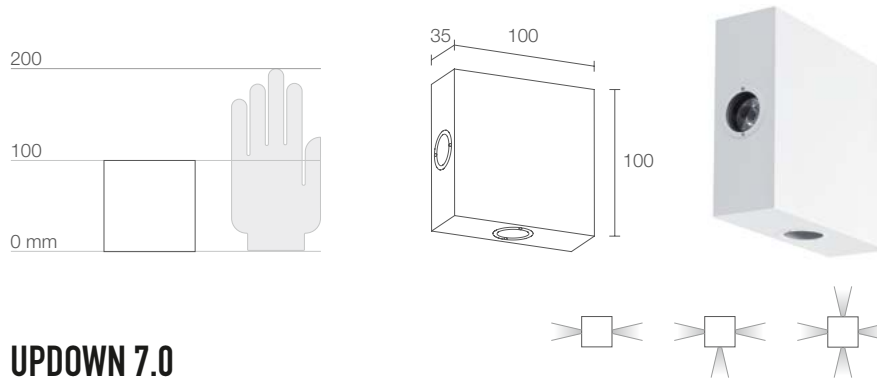

UPDOWN 7.0



POWER / POWER SUPPLY CODE

max 4W	max 500mA	double beam
UD7022	E	White
UD7022	A	Anodized grey
UD7022	H	Anthracite
UD7022	T	Cor-ten
max 6W	max 500mA	3 beams
UD7032	E	White
UD7032	A	Anodized grey
UD7032	H	Anthracite
UD7032	T	Cor-ten
max 8W	max 500mA	4 beams
UD7042	E	White
UD7042	A	Anodized grey
UD7042	H	Anthracite
UD7042	T	Cor-ten

LED COLOUR	F - 2700K 5 - 3000K 9 - 4000K 1 - blue
OPTICS	S - 10° M - 20° L - 40°

LUMEN OUTPUT AT SOURCE	290 lm (3000K, 500mA) 435 lm (3000K, 500mA) 580 lm (3000K, 500mA)
DELIVERED LUMEN OUTPUT	206 lm (3000K, 500mA, 20°) 309 lm (3000K, 500mA, 20°) 412 lm (3000K, 500mA, 20°)
NO. AND TYPE OF LED	2, 3, 4 power LEDs, 1/4 ANSI BIN (white LED colour) 50000h L90 B10 (Ta 25°C)
MATERIAL	body in anodized aluminium screen in transparent, tempered glass
POWER SUPPLY UNIT	not included, see p. 904
POWER CABLES	includes 0.30 m PVC cable FROR 2x0.35 Ø3.5 mm
WIRING	series
MOUNTING	surface mounted (wall)
PHOTOMETRIC DATA	see p. 898



VIGNAIOLI
CONTRÀ
S  ARDA

ACCESSORIES

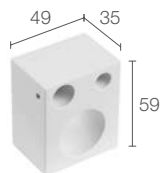
ACCESSORIES
FOR INSTALLATION

WD0103 - White

WD0100 - Anodized grey

WD0104 - Anthracite

WD0102 - Cor-ten

Spacer

RAL finish available on request

(Updown 3 / 4)



OUTDOOR WALL MOUNTED WITH SINGLE- OR DOUBLE-BEAM OPTICS

2700K 3000K 4000K



SINGLE BEAM



DOUBLE BEAM

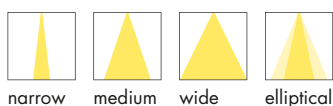

narrow medium wide elliptical



BROM 1.0 p. 366
max 2W max 500mA
88 lm (3000K, 500mA, 20°)



BROM 2.0 p. 366
max 4W max 500mA
176 lm (3000K, 500mA, 20°)



narrow medium wide



BROM 3.0 p. 367
max 6W max 500mA
251 lm (3000K, 500mA, 20°)



BROM 4.0 p. 367
max 12W max 500mA
502 lm (3000K, 500mA, 20°)

< **BROM 3.0**
3000K, 6W, 12°
BROM 4.0
3000K, 12W, UP optics 12° / DOWN optics 12°
Project by / geom. Giuseppe Carannante
Villa Punta Pennata, Bacoli, Naples, Italy

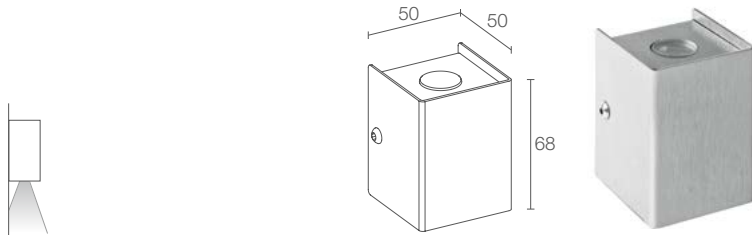
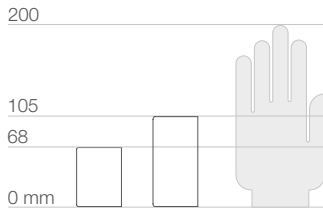

BROM 1.0



POWER / POWER SUPPLY CODE	max 2W max 500mA BR10012 ■ ■ ■ I
■ LED COLOUR	F - 2700K 5 - 3000K 9 - 4000K
■ OPTICS	S - 10° M - 20° L - 40° W - 10°x45°

LUMEN OUTPUT AT SOURCE	145 lm (3000K, 500mA)
DELIVERED LUMEN OUTPUT	88 lm (3000K, 500mA, 20°)
NO. AND TYPE OF LED	1 power LED 1/4 ANSI BIN (white LED colour) 50000h L90 B10 (Ta 25°C)
MATERIAL	body and trim in AISI 316L stainless steel screen in transparent, tempered extra-clear glass
POWER SUPPLY UNIT	not included, see p. 904
POWER CABLES	includes 2x0.30 m single-core cables
WIRING	series
MOUNTING	surface mounted (wall)
PHOTOMETRIC DATA	see p. 805

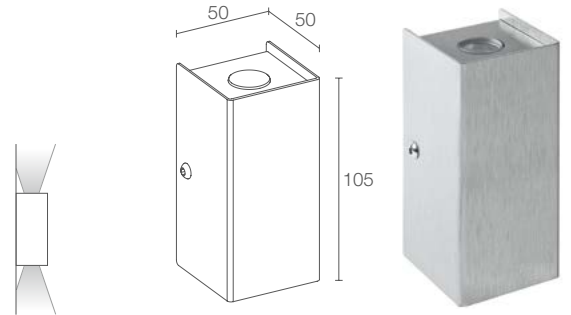

BROM 2.0



POWER / POWER SUPPLY CODE	max 4W max 500mA BR20022 ■ ■ ■ I
■ LED COLOUR	F - 2700K 5 - 3000K 9 - 4000K
■ OPTICS	UP optics: S - 10° M - 20° L - 40° W - 10°x45° DOWN optics: S - 10° M - 20° L - 40° W - 10°x45°

LUMEN OUTPUT AT SOURCE	290 lm (3000K, 500mA)
DELIVERED LUMEN OUTPUT	176 lm (3000K, 500mA, 20°)
NO. AND TYPE OF LED	2 power LEDs 1/4 ANSI BIN (white LED colour) 50000h L90 B10 (Ta 25°C)
MATERIAL	body and trim in AISI 316L stainless steel screen in transparent, tempered extra-clear glass
POWER SUPPLY UNIT	not included, see p. 904
POWER CABLES	includes 2x0.30 m single-core cables
WIRING	series
MOUNTING	surface mounted (wall)
PHOTOMETRIC DATA	see p. 805

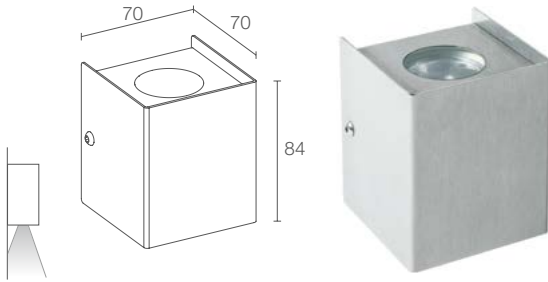
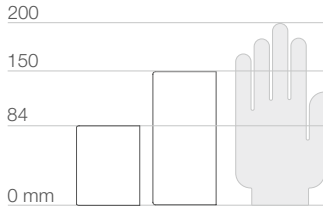

BROM 3.0

kg 0.45
 IP66 IK08
 CASAMBI

max 6W max 500mA
BR30032 ■ ■ ■ I

■ **F** - 2700K
5 - 3000K
9 - 4000K

■ **S** - 12°
M - 20°
L - 35°

436 lm (3000K, 500mA)

251 lm (3000K, 500mA, 20°)

3 power LEDs
 1/4 ANSI BIN (white LED colour)
 50000h L90 B10 (Ta 25°C)

body and trim in AISI 316L stainless steel
 screen in transparent, tempered extra-clear glass

not included, see p. 904

includes 2x0.30 m single-core cables

series

surface mounted (wall)

see p. 805

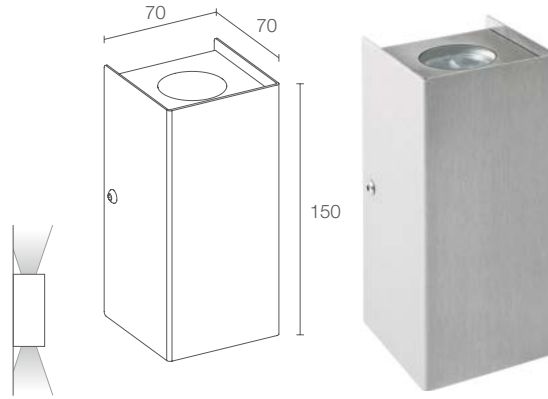

BROM 4.0

kg 0.80
 IP66 IK08
 CASAMBI

max 12W max 500mA
BR40062 ■ ■ ■ I

■ **F** - 2700K
5 - 3000K
9 - 4000K

■ UP optics:
S - 12°
M - 20°
L - 35°

■ DOWN optics:
S - 12°
M - 20°
L - 35°

872 lm (3000K, 500mA)

502 lm (3000K, 500mA, 20°)

6 power LEDs
 1/4 ANSI BIN (white LED colour)
 50000h L90 B10 (Ta 25°C)

body and trim in AISI 316L stainless steel
 screen in transparent, tempered extra-clear glass

not included, see p. 904

includes 2x0.30 m single-core cables

series

surface mounted (wall)

see p. 805

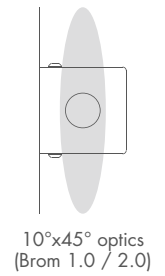



CUBE W

OUTDOOR WALL MOUNTED OPTICS WITH WHITE AND RGB LIGHT

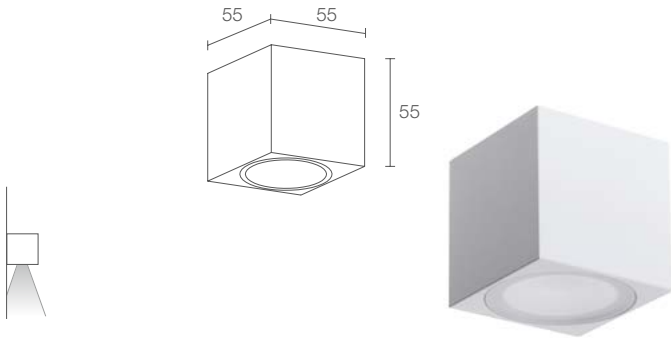

CUBE W 1.0



POWER / POWER SUPPLY CODE

max 6W max 500mA blue/white light
CU1032 ■ ■ ■ E White
CU1032 ■ ■ ■ H Anthracite
CU1032 ■ ■ ■ T Cor-ten

max 3W max 350mA RGB light
CU1031 6 ■ ■ ■ E White
CU1031 6 ■ ■ ■ H Anthracite
CU1031 6 ■ ■ ■ T Cor-ten

LED COLOUR

F - 2700K
5 - 3000K
9 - 4000K
0 - 5000K
1 - blue

OPTICS

S - 18°
M - 28°
L - 36°

LUMEN OUTPUT AT SOURCE

410 lm (3000K, 500mA)
 RGB: 197 lm, R: 62 lm G: 100 lm
 B: 35 lm (350mA)

DELIVERED LUMEN OUTPUT

337 lm (3000K, 500mA, 28°)
 RGB: 163 lm, R: 51 lm G: 83 lm
 B: 29 lm (350mA, 28°)

NO. AND TYPE OF LED

3 power LEDs
 1/4 ANSI BIN (white LED colour)
 50000h L90 B10 (Ta 25°C)

MATERIAL

body in anodized aluminium
 screen in frosted plexiglass

POWER SUPPLY UNIT

not included, see p. 904 and 917

POWER CABLES

includes 2x0.30 m single-core cables
 RGB: includes 1.5m PVC cable
 FROR 6x0.25 Ø5 mm

WIRING

series

MOUNTING

surface mounted (wall)

NOTES

ceiling-mounted version: Cube C 1.2, p. 387

PHOTOMETRIC DATA

see p. 820

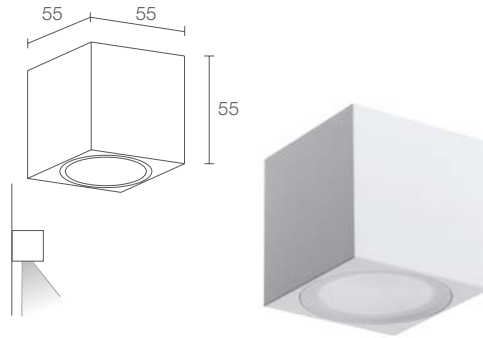
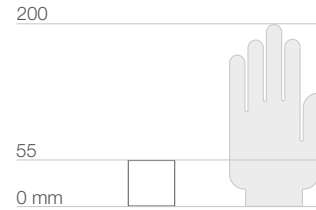

CUBE W 1.1



POWER / POWER SUPPLY CODE

max 6W max 500mA blue/white light
CU1132 ■ ■ ■ E White
CU1132 ■ ■ ■ H Anthracite
CU1132 ■ ■ ■ T Cor-ten

max 3W max 350mA RGB light
CU1131 6 ■ ■ ■ E White
CU1131 6 ■ ■ ■ H Anthracite
CU1131 6 ■ ■ ■ T Cor-ten

LED COLOUR

F - 2700K
5 - 3000K
9 - 4000K
0 - 5000K
1 - blue

OPTICS

S - 18° tilted 20°
M - 28° tilted 20°
L - 36° tilted 20°

410 lm (3000K, 500mA)
 RGB: 197 lm, R: 62 lm G: 100 lm
 B: 35 lm (350mA)

295 lm (3000K, 500mA, 28°)
 RGB: 141 lm, R: 44 lm G: 72 lm
 B: 25 lm (350mA, 28°)

3 power LEDs
 1/4 ANSI BIN (white LED colour)
 50000h L90 B10 (Ta 25°C)

body in anodized aluminium
 screen in frosted plexiglass

not included, see p. 904 and 917

includes 2x0.30 m single-core cables
 RGB: includes 1.5m PVC cable
 FROR 6x0.25 Ø5 mm

series

surface mounted (wall)

ceiling-mounted version: Cube C 1.3, p. 387

see p. 820



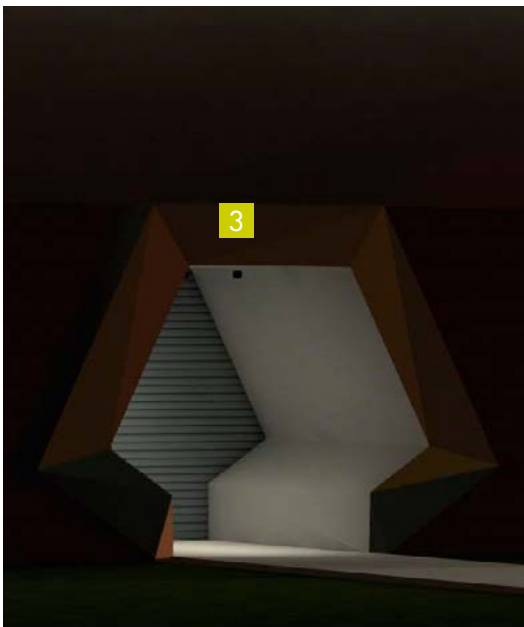

CEILING MOUNTED FOR OUTDOOR APPLICATIONS

LIVING SPACES

INTONO C OUT p. 374 **1**

ELLO OUT p. 380 **2**

CUBE C p. 386 **3**



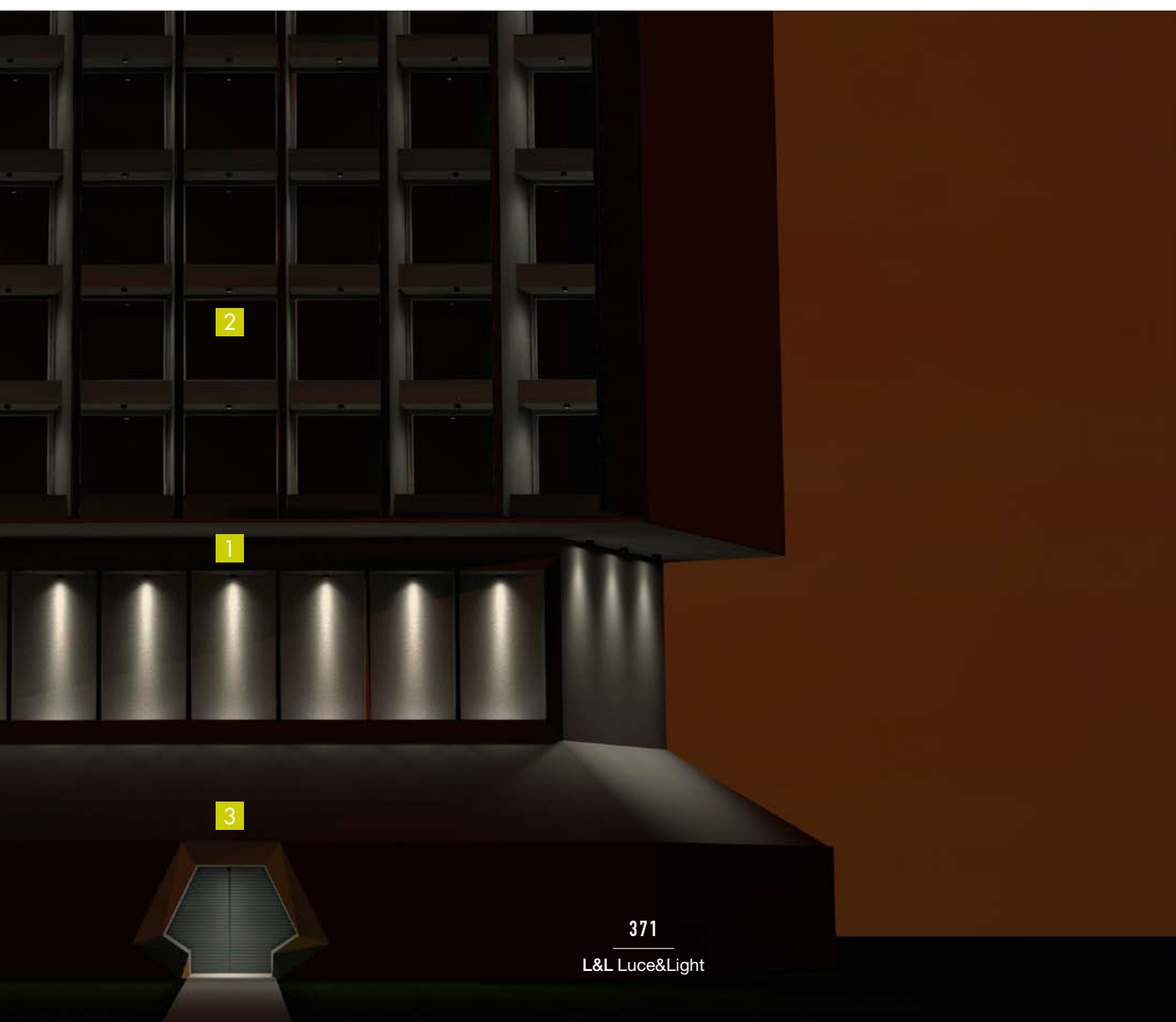



TAK p. 388 **4**





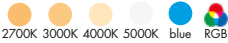

LIVING SPACES

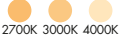
BEAM

LIGHT COLOUR

<p>INTONO C OUT see p. 374</p> 	<p>DIFFUSE VERSION OPTICS VERSION</p>	 <p>2700K 3000K 4000K</p>
<p>ELLO OUT see p. 380</p> 	<p>DIFFUSE VERSION</p>	 <p>2700K 3000K 4000K</p>
<p>CUBE C see p. 386</p> 	<p>OPTICS VERSION</p>	 <p>2700K 3000K 4000K 5000K blue RGB</p>
<p>TAK see p. 388</p> 	<p>DIFFUSE VERSION OPTICS VERSION</p>	 <p>2700K 3000K 4000K</p>

CEILING MOUNTED FOR OUTDOOR APPLICATIONS

POWER	POWER SUPPLY	IP	APPLIANCE CLASS
9–20W	24Vdc 230Vac	IP65	 
7–19W	MAINS VOLTAGE (built-in power supply unit) 230Vac	IP65	
max 3W (RGB light) max 6W (white/blue light)	CONSTANT CURRENT (power supply unit not included) max 350mA (RGB light) max 500mA (white/blue light)	IP54	
10–18W	MAINS VOLTAGE (built-in power supply unit) 230Vac	IP65	



INTONO C OUT

OUTDOOR CEILING MOUNTED WITH LIGHT OUTPUT ALONE OR ALSO WITH SPEAKER FOR PRIVATE HOMES AND HOSPITALITY

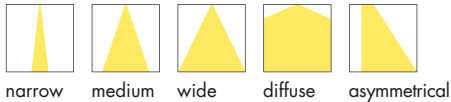

2700K 3000K 4000K

OUTDOOR

INDOOR

CEILING MOUNTED

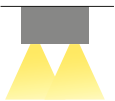

INTONO C OUT 2.4 p. 376
12W 230Vac
ON/OFF

INTONO C IN p. 644



INTONO C OUT 3.4 p. 377
20W 230Vac
ON/OFF, DALI, 0/1-10V

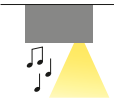

INTONO C OUT 3.9 p. 377
9W 24Vdc

WALL MOUNTED

INTONO p. 324



^
INTONO C OUT 3.9
 speaker:
 maximum power
 nominal impedance Z
 mean sound pressure level

3W
 16 Ohm
 86 dB (1W/1m)

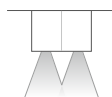
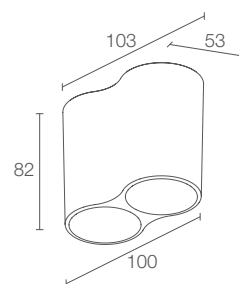

INTONO C OUT 2.4

CE LED TECH kg 0.60 IP65 IK06
 A+ A+ A++

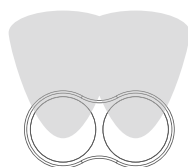

Asymmetrical optics
 (Intono C OUT 3.4)

POWER / POWER SUPPLY CODE 12W 230Vac
NC2410 00 **E** White
NC2410 00 **F** Grey
NC2410 00 **H** Anthracite
NC2410 00 **T** Cor-ten
NC2410 00 **7** Primer

CRI 0 - CRI 80
 1 - CRI >90

CONTROL SYSTEM on/off

HONEYCOMB LOUVRE 0 - not present
 1 - present
 (not compatible with diffuse optics)

LED COLOUR F - 2700K
 5 - 3000K
 9 - 4000K

OPTICS TT - 11°
 MM - 34°
 KK - 68°
 DD - diffuse

LUMEN OUTPUT AT SOURCE 976 lm (3000K, CRI 80)

DELIVERED LUMEN OUTPUT 704 lm (3000K, 34°, CRI 80)

NO. AND TYPE OF LED 2 power LEDs
 3-step MacAdam, 50000h L90 B10 (Ta 25°C)

MATERIAL body in die-cast aluminium
 screen in black-serigraphed and transparent,
 tempered extra-clear glass

POWER SUPPLY UNIT built in

MOUNTING surface mounted (ceiling)

ACCESSORIES none

NOTES indoor version: Intono C IN 2.3, p. 646
 wall-mounted version: Intono, p. 324
 version compatible with Google Home or Amazon Echo
 available on request for voice command control
 Casambi-compatible version, controllable with
 the Casambi app, available on request

PHOTOMETRIC DATA see p. 839

v
INTONO C OUT 3.4
 painted primer version



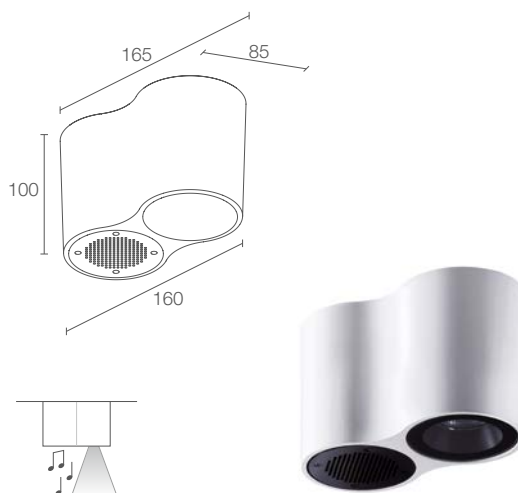
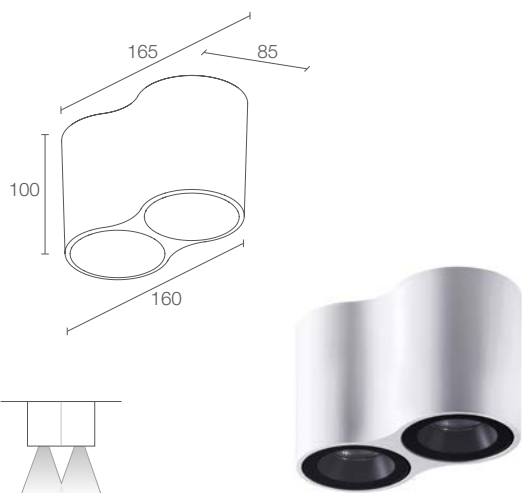

INTONO C OUT 3.4

INTONO C OUT 3.9

CE LED TECH kg 1.35 IP65 IK06 DALI 0/1-10V
A A+ A++

CE LED TECH kg 1.35 IP65 IK06
A A+ A++

20W 230Vac

NC3410 0 1 2 3 4 5 6 7 8 9 E White
 NC3410 0 1 2 3 4 5 6 7 8 9 F Grey
 NC3410 0 1 2 3 4 5 6 7 8 9 H Anthracite
 NC3410 0 1 2 3 4 5 6 7 8 9 T Cor-ten
 NC3410 0 1 2 3 4 5 6 7 8 9 7 Primer

9W 24Vdc

NC3900 00 01 02 03 04 05 06 07 08 09 M9 E White
 NC3900 00 01 02 03 04 05 06 07 08 09 M9 F Grey
 NC3900 00 01 02 03 04 05 06 07 08 09 M9 H Anthracite
 NC3900 00 01 02 03 04 05 06 07 08 09 M9 T Cor-ten
 NC3900 00 01 02 03 04 05 06 07 08 09 M9 7 Primer

0 - CRI 80
1 - CRI >90

0 - CRI 80
1 - CRI >90

0 - on/off
D - DALI
R - 0/1-10V

0 - not present
1 - present

0 - not present
1 - present
(not compatible with the asymmetrical optics)

F - 2700K
5 - 3000K
9 - 4000K

F - 2700K
5 - 3000K
9 - 4000K

SS - 15°
MM - 20°
LL - 43°
AA - asymmetrical

20°

1976 lm (3000K, CRI 80)

988 lm (3000K, CRI 80)

1674 lm (3000K, 15°, CRI 80)

783 lm (3000K, 20°, CRI 80)

2 high power density COB LEDs
2-step MacAdam, 50000h L95 B10 (Ta 25°C)

1 high power density COB LED
2-step MacAdam, 50000h L95 B10 (Ta 25°C)

body in die-cast aluminium
screen in black-serigraphed and transparent,
tempered extra-clear glass

body in die-cast aluminium
screen in black-serigraphed and transparent,
tempered extra-clear glass

built in

not included, see p. 904

surface mounted (ceiling)

surface mounted (ceiling)

none

see p. 378

indoor version: Intono C IN 3.3, p. 647
wall-mounted version: Intono, p. 324
version compatible with Google Home or Amazon Echo
available on request for voice command control
Casambi-compatible version, controllable with
the Casambi app, available on request

indoor version: Intono C IN 3.8, p. 647
wall-mounted version: Intono, p. 324
version compatible with Google Home or Amazon Echo
available on request for voice command control
Casambi-compatible version, controllable with
the Casambi app, available on request

see p. 839

see p. 839

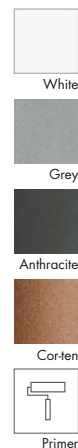

ACCESSORIES



WUNT39A00

Bluetooth 3.0 audio control kit with power supply unit and amplifier (for Alexa or Google voice-control systems)
(Intono C OUT 3.9)



WUNT39A01

Wi-Fi light control kit
(Intono C OUT 3.9)

∨
INTONO C OUT 3.4
20W, asymmetrical optics



ACCESSORIES

√
INTONO C OUT 3.4
20W, asymmetrical optics





ELLO OUT

OUTDOOR CEILING MOUNTED WITH DIFFUSE LIGHT



diffuse



2700K 3000K 4000K

OUTDOOR

INDOOR

CEILING MOUNTED

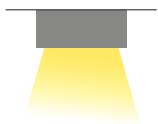

ELLO OUT 1.0 p. 382
7W 230Vac
493 lm (3000K)



ELLO OUT 2.0 p. 383
16W 230Vac
985 lm (3000K)



ELLO OUT 3.0 p. 383
19W 230Vac
1478 lm (3000K)

ELLO IN p. 658

WALL MOUNTED

ELLA OUT p. 350

ELLA IN p. 622

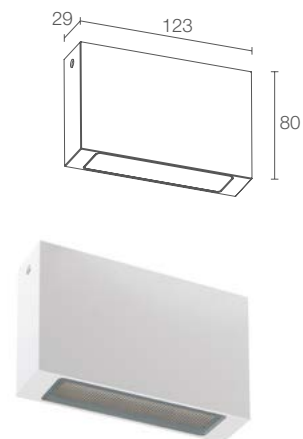

ELLO OUT 1.0

CE EAC LED TECH kg 0.40 IP65 IK08
 A A+ A++

POWER / POWER SUPPLY CODE 7W 230Vac
EP1010 **DET** White
EP1010 **DFT** Grey
EP1010 **DHT** Anthracite
EP1010 **DTT** Cor-ten

LED COLOUR
F - 2700K
5 - 3000K
9 - 4000K

OPTICS diffuse

LUMEN OUTPUT AT SOURCE 954 lm (3000K)

DELIVERED LUMEN OUTPUT 493 lm (3000K)

NO. AND TYPE OF LED 18 mid-power LEDs
 3-step MacAdam, 50000h L80 B10 (Ta 25°C)

MATERIAL body in aluminium
 screen in serigraphed extra-clear microprismatic glass

POWER SUPPLY UNIT built in

POWER CABLES includes 1.5 m neoprene cable
 H05RN-F 3x1.00 Ø7.0 mm

MOUNTING surface mounted (ceiling)

ACCESSORIES see p. 385

NOTES indoor version: Ello IN 1.0, p. 660
 wall-mounted version: Ella OUT 1.0, p. 352
 Casambi-compatible version, controllable with
 the Casambi app, available on request

PHOTOMETRIC DATA see p. 824

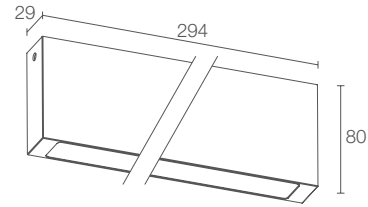
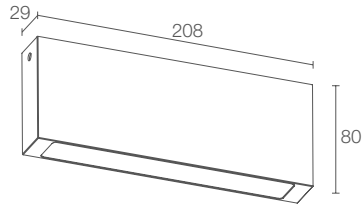

ELLO OUT 2.0

CE ENEC LED TECH kg 0.80 IP65 IK08
 A A+ A++

16W 230Vac
EP2010 D E T White
EP2010 D F T Grey
EP2010 D H T Anthracite
EP2010 D T T Cor-ten

F - 2700K
 5 - 3000K
 9 - 4000K

diffuse

1908 lm (3000K)

985 lm (3000K)

36 mid-power LEDs
 3-step MacAdam, 50000h L80 B10 (Ta 25°C)

body in aluminium
 screen in serigraphed extra-clear microprismatic glass

built in

includes 1.5 m neoprene cable
 H05RN-F 3x1.00 Ø7.0 mm

surface mounted (ceiling)

see p. 385

indoor version: Ello IN 2.0, p. 661
 wall-mounted version: Ella OUT 2.0, p. 353
 Casambi-compatible version, controllable with
 the Casambi app, available on request

see p. 824

ELLO OUT 3.0

CE ENEC LED TECH kg 1.20 IP65 IK08
 A A+ A++

19W 230Vac
EP3010 D E T White
EP3010 D F T Grey
EP3010 D H T Anthracite
EP3010 D T T Cor-ten

F - 2700K
 5 - 3000K
 9 - 4000K

diffuse

2862 lm (3000K)

1478 lm (3000K)

54 mid-power LEDs
 3-step MacAdam, 50000h L80 B10 (Ta 25°C)

body in aluminium
 screen in serigraphed extra-clear microprismatic glass

built in

includes 1.5 m neoprene cable
 H05RN-F 3x1.00 Ø7.0 mm

surface mounted (ceiling)

see p. 385

indoor version: Ello IN 3.0, p. 661
 wall-mounted version: Ella OUT 3.0, p. 353
 Casambi-compatible version, controllable with
 the Casambi app, available on request

see p. 824





ACCESSORIES

ACCESSORIES FOR INSTALLATION

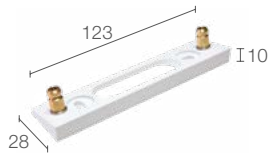

WD0651E - White
WD0651F - Grey
WD0651H - Anthracite
WD0651T - Cor-ten
 Spacer for 15° inclination
 RAL finish available on request
 (Ello OUT 1.0)

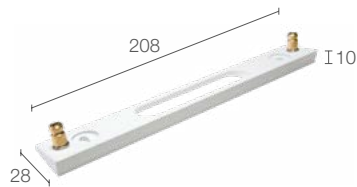

WD0652E - White
WD0652F - Grey
WD0652H - Anthracite
WD0652T - Cor-ten
 Spacer for 15° inclination
 RAL finish available on request
 (Ello OUT 2.0)

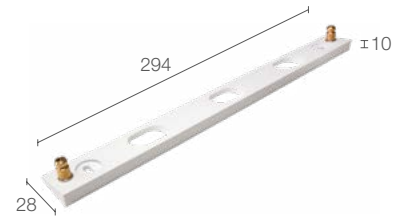

WD0653E - White
WD0653F - Grey
WD0653H - Anthracite
WD0653T - Cor-ten
 Spacer for 15° inclination
 RAL finish available on request
 (Ello OUT 3.0)

∨
ELLO OUT 1.0
 with spacer (15° inclination)



STANDARD FINISHES



White



Grey



Anthracite



Cor-ten



CUBE C

OUTDOOR CEILING MOUNTED OPTICS WITH WHITE AND RGB LIGHT

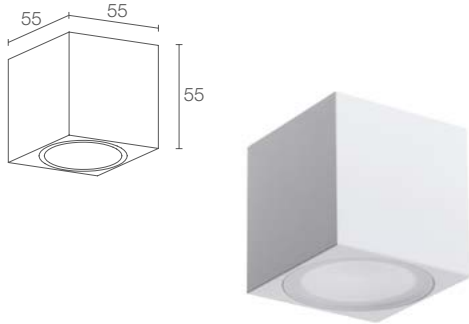
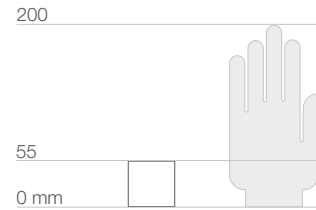

CUBE C 1.2

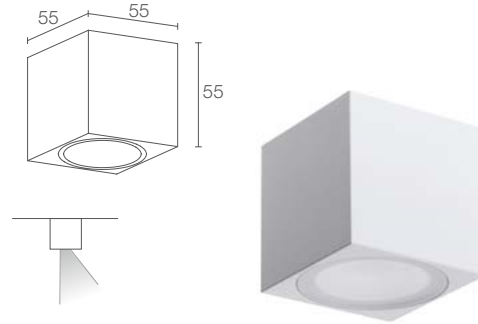

CUBE C 1.3



POWER / POWER SUPPLY CODE

max 6W max 500mA blue/white light
CU1232 ■ ■ ■ **E** White
CU1232 ■ ■ ■ **H** Anthracite
CU1232 ■ ■ ■ **T** Cor-ten

max 3W max 350mA RGB light
CU1231 6 ■ ■ ■ **E** White
CU1231 6 ■ ■ ■ **H** Anthracite
CU1231 6 ■ ■ ■ **T** Cor-ten

LED COLOUR

F - 2700K
5 - 3000K
9 - 4000K
0 - 5000K
1 - blue

OPTICS

S - 18°
M - 28°
L - 36°

LUMEN OUTPUT AT SOURCE 410 lm (3000K, 500mA)
 RGB: 197 lm, R: 62 lm G: 100 lm
 B: 35 lm (350mA)

DELIVERED LUMEN OUTPUT 337 lm (3000K, 500mA, 28°)
 RGB: 163 lm, R: 51 lm G: 83 lm
 B: 29 lm (350mA, 28°)

NO. AND TYPE OF LED 3 power LEDs
 1/4 ANSI BIN (white LED colour)
 50000h L90 B10 (Ta 25°C)

MATERIAL body in anodized aluminium
 screen in frosted plexiglass

POWER SUPPLY UNIT not included, see p. 904 and 917

POWER CABLES includes 2x0.30 m single-core cables
 RGB: includes 1.5m PVC cable
 FROR 6x0.25 Ø5 mm

WIRING series

MOUNTING surface mounted (ceiling)

NOTES wall-mounted version: Cube W 1.0, p. 369

PHOTOMETRIC DATA see p. 820

max 6W max 500mA blue/white light
CU1332 ■ ■ ■ **E** White
CU1332 ■ ■ ■ **H** Anthracite
CU1332 ■ ■ ■ **T** Cor-ten

max 3W max 350mA RGB light
CU1331 6 ■ ■ ■ **E** White
CU1331 6 ■ ■ ■ **H** Anthracite
CU1331 6 ■ ■ ■ **T** Cor-ten

F - 2700K
5 - 3000K
9 - 4000K
0 - 5000K
1 - blue

S - 18° tilted 20°
M - 28° tilted 20°
L - 36° tilted 20°

LUMEN OUTPUT AT SOURCE 410 lm (3000K, 500mA)
 RGB: 197 lm, R: 62 lm G: 100 lm
 B: 35 lm (350mA)

DELIVERED LUMEN OUTPUT 295 lm (3000K, 500mA, 28°)
 RGB: 141 lm, R: 44 lm G: 72 lm
 B: 25 lm (350mA, 28°)

NO. AND TYPE OF LED 3 power LEDs
 1/4 ANSI BIN (white LED colour)
 50000h L90 B10 (Ta 25°C)

MATERIAL body in anodized aluminium
 screen in frosted plexiglass

POWER SUPPLY UNIT not included, see p. 904 and 917

POWER CABLES includes 2x0.30 m single-core cables
 RGB: includes 1.5m PVC cable
 FROR 6x0.25 Ø5 mm

WIRING series

MOUNTING surface mounted (ceiling)

NOTES wall-mounted version: Cube W 1.1, p. 369

PHOTOMETRIC DATA see p. 820





OUTDOOR CEILING MOUNTED WITH DIFFUSE LIGHT OR OPTICS

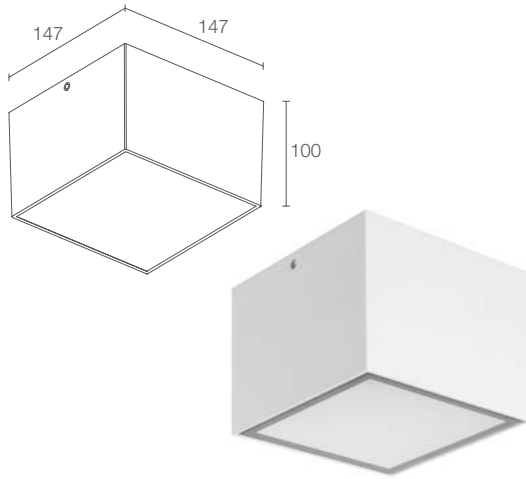

TAK 1.0

CE ENEC LED TECH kg 2.36 IP65 IK06
A A+ A++

POWER / POWER SUPPLY CODE

18W 230Vac
TA1011 **D E** White
TA1011 **D F** Grey
TA1011 **D H** Anthracite
TA1011 **D T** Cor-ten

LED COLOUR

F - 2700K
5 - 3000K
9 - 4000K

OPTICS

diffuse

LUMEN OUTPUT AT SOURCE 875 lm (3000K)

DELIVERED LUMEN OUTPUT 671 lm (3000K)

NO. AND TYPE OF LED power LED matrix
1/4 ANSI BIN, 50000h L90 B10 (Ta 25°C)

MATERIAL body in die-cast aluminium
screen in sandblasted,
tempered extra-clear glass

POWER SUPPLY UNIT built in

POWER CABLES connection box with 0.30 m cable

MOUNTING surface mounted (ceiling)

NOTES Casambi-compatible version,
controllable with the Casambi app,
available on request

PHOTOMETRIC DATA see p. 893

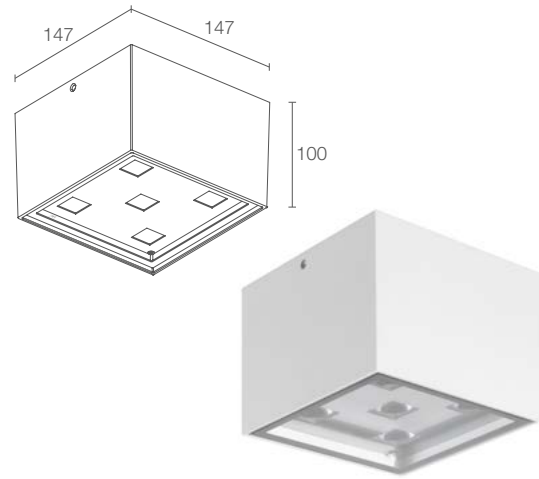

TAK 1.1

CE ENEC LED TECH kg 2.36 IP65 IK06
A A+ A++ PID

10W 230Vac
TA1110 **E** White
TA1110 **F** Grey
TA1110 **H** Anthracite
TA1110 **T** Cor-ten

18W 230Vac
TA1111 **E** White
TA1111 **F** Grey
TA1111 **H** Anthracite
TA1111 **T** Cor-ten

F - 2700K
5 - 3000K
9 - 4000K

S - 10°
F - 30°
K - 70°

727 lm (3000K, 10W)
1308 lm (3000K, 18W)

495 lm (3000K, 30°, 10W)
883 lm (3000K, 30°, 18W)

5, 9 power LEDs
1/4 ANSI BIN, 50000h L90 B10 (Ta 25°C)

body in die-cast aluminium
screen in sandblasted,
tempered extra-clear glass

built in

connection box with 0.30 m cable

surface mounted (ceiling)

Casambi-compatible version,
controllable with the Casambi app,
available on request

see p. 893

























STEP LIGHTS FOR OUTDOOR APPLICATIONS

RONDÒ p. 394	1
BEAM p. 406	2
BRIGHT p. 412	3
PASITO p. 420	4
STEP OUTSIDE p. 430	5
LIRA p. 444	6
ICE LED p. 448	7



		MOUNTING	BEAM	LUMINOUS INTENSITY
RONDÒ see p. 394 SMALL PATHS AND CAR PARKS		GROUND semi-recessed (drive-over)	RADIAL OPTICS 1 / 2 / 4 beams	
BEAM see p. 406 WALKWAYS		GROUND WALL semi-recessed (walk-over)	RADIAL OPTICS single beam / double beam	
BRIGHT see p. 412 SMALL PATHS AND CAR PARKS		GROUND WALL semi-recessed (drive-over / walk-over)	RADIAL OPTICS 1 / 2 / 3 / 4 beams	
PASITO see p. 420 PATHWAYS AND STEPS		WALL recessed installation, flush recessed installation, with frame surface	ASYMMETRICAL OPTICS	
STEP OUTSIDE see p. 430 ORIENTATION LIGHTING AND WALKWAYS		WALL recessed installation, with frame semi-recessed surface	DIFFUSE OPTICS ASYMMETRICAL OPTICS	
LIRA see p. 444 PATHWAYS AND STEPS		WALL surface	ASYMMETRICAL OPTICS	
ICE LED see p. 448 FLOWERBEDS AND GARDENS		GROUND WALL recessed installation surface	DIFFUSE OPTICS	

STEP LIGHTS FOR OUTDOOR APPLICATIONS

LIGHT COLOUR	POWER SUPPLY	IP	APPLIANCE CLASS
 2700K 3000K 4000K	CONSTANT VOLTAGE (power supply unit not included) 24Vdc MAINS VOLTAGE (built-in power supply unit) 230Vac	IP67	
 2700K 3000K 4000K 5000K blue	CONSTANT CURRENT (power supply unit not included) max 350mA (double beam) max 500mA (single beam) CONSTANT VOLTAGE (power supply unit not included) 24Vdc	IP67	
 2700K 3000K 4000K blue	CONSTANT CURRENT (power supply unit not included) max 700mA CONSTANT VOLTAGE (power supply unit not included) 24Vdc	IP65 IP67 IP68	
 2700K 3000K 4000K	CONSTANT VOLTAGE (power supply unit not included) 24Vdc MAINS VOLTAGE (built-in power supply unit) 230Vac	IP65	
 2700K 3000K 4000K 5000K blue	CONSTANT CURRENT (power supply unit not included) max 500mA CONSTANT VOLTAGE (power supply unit not included) 24Vdc	IP54 IP65	
 2700K 3000K 4000K	MAINS VOLTAGE (built-in power supply unit) 230Vac	IP65	
 2700K 3000K 4000K 5000K blue	CONSTANT CURRENT (power supply unit not included) max 350mA	IP67	



DRIVE-OVER OUTDOOR STEP LIGHTS FOR ORIENTATION LIGHTING IN PATHS AND PARKING AREAS

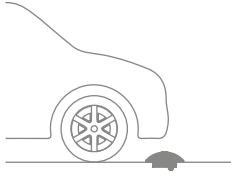

radial

narrow



2700K 3000K 4000K

Ø100 mm

Ø160 mm

SINGLE BEAM



RONDÒ 1.1 p. 398
2W 24Vdc



RONDÒ 3.1 p. 402
3W 24Vdc
3W 230Vac



RONDÒ 2.1 p. 399
2W 24Vdc

DOUBLE BEAM



RONDÒ 1.2 p. 399
4W 24Vdc



RONDÒ 3.2 p. 403
5W 24Vdc
5W 230Vac

4 BEAMS

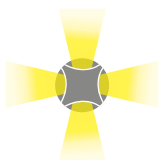

RONDÒ 3.4 p. 403
8W 24Vdc
8W 230Vac



IP67
SUITABLE FOR OUTDOOR
APPLICATIONS



BUILT-IN PROTECTION SYSTEMS:
IPS
INTELLIGENT PROTECTION SYSTEM



PID
PROTECTIVE IMPEDANCE DEVICE
(RONDÒ 3)



DRIVE-OVER
UP TO 5000 KG



5-STEP MATERIAL PROTECTION,
AND OXIDATION AND
CORROSION RESISTANCE
Preparation for painting
Epoxy paint
Polyester paint
Paints compliant with Qualicoat automotive coating standard
Salt spray tested (over 1000 hours)



BODY IN AISI 316L
STAINLESS STEEL, MADE
ENTIRELY ON A CNC LATHE

SCREEN IN ANTI-UV
POLYCARBONATE

TAMPER-RESISTANT
SCREW IN AISI 316L
STAINLESS STEEL IN THE
SAME FINISH AS THE FIXTURE



UNIQUE SELLING POINTS



COR-TEN



RAL FINISH
ON REQUEST



ANTHRACITE



STAINLESS STEEL



10° OPTICS



RADIAL OPTICS



DOUBLE BEAM, RADIAL OPTICS

√
RONDÒ 1.2
 3000K, 4W, radial, anthracite
LIRA 1.0
 3000K, 6W, asymmetrical, anthracite
UPDOWN 3.6
 3000K, 6W, 15°, anodized grey
 Project by / arch. Patrik Spreafico
 Plastic Stratosfera, Robbiate, Lecco, Italy

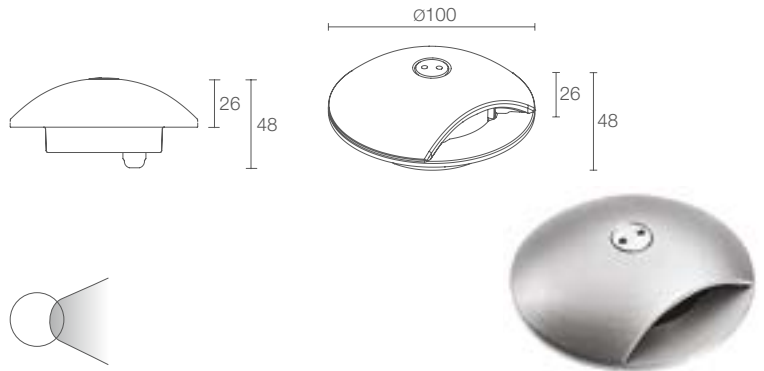

RONDÒ 1.1



POWER / POWER SUPPLY CODE

2W 24Vdc
RD1100 ■ H - ■ Anthracite
RD1100 ■ I - ■ Stainless steel
RD1100 ■ T - ■ Cor-ten

LED COLOUR

F - 2700K
5 - 3000K
9 - 4000K

OPTICS

S - 10°
A - radial

POWER CABLES

includes 1.5 m neoprene cable
 H05RN-F 2x0.35/0.75 Ø6.3 mm
1 - 5 m
2 - 10 m
3 - 15 m
4 - 20 m

LUMEN OUTPUT AT SOURCE 185 lm (3000K)

DELIVERED LUMEN OUTPUT 65 lm (3000K, radial optics)

NO. AND TYPE OF LED 1 power LED
1/4 ANSI BIN, 50000h L95 B10 (Ta 25°C)

MATERIAL body in AISI 316L stainless steel
screen in Rilsan® Clear

POWER SUPPLY UNIT not included, see p. 904

MOUNTING recessed (ground)

ACCESSORIES see p. 405

PHOTOMETRIC DATA see p. 872



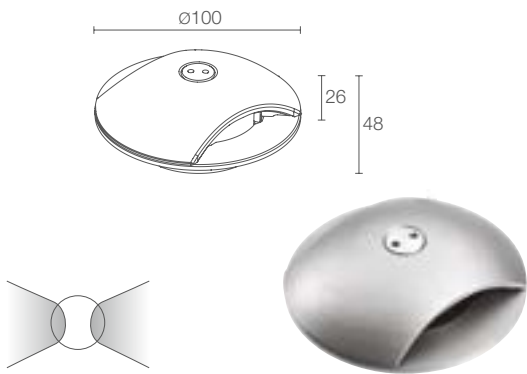

RONDÒ 1.2

4W 24Vdc

RD1200 **H** - Anthracite
RD1200 **I** - Stainless steel
RD1200 **T** - Cor-ten

	F - 2700K 5 - 3000K 9 - 4000K
	S - 10° A - radial
	includes 1.5 m neoprene cable H05RN-F 2x0.35/0.75 Ø6.3 mm 1 - 5 m 2 - 10 m 3 - 15 m 4 - 20 m

370 lm (3000K)

130 lm (3000K, radial optics)

2 power LEDs
1/4 ANSI BIN, 50000h L95 B10 (Ta 25°C)

body in AISI 316L stainless steel
screen in Rilsan® Clear

not included, see p. 904

recessed (ground)

see p. 405

see p. 872

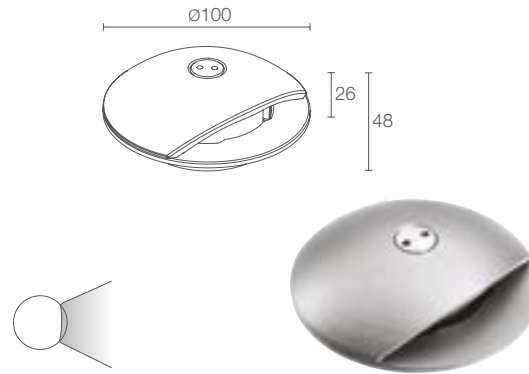

RONDÒ 2.1

2W 24Vdc

RD2100 **H** - Anthracite
RD2100 **I** - Stainless steel
RD2100 **T** - Cor-ten

	F - 2700K 5 - 3000K 9 - 4000K
	S - 10° A - radial
	includes 1.5 m neoprene cable H05RN-F 2x0.35/0.75 Ø6.3 mm 1 - 5 m 2 - 10 m 3 - 15 m 4 - 20 m

185 lm (3000K)

85 lm (3000K, radial optics)

1 power LED
1/4 ANSI BIN, 50000h L95 B10 (Ta 25°C)

body in AISI 316L stainless steel
screen in Rilsan® Clear

not included, see p. 904

recessed (ground)

see p. 405

see p. 872







RONDÒ 1.1

3000K, 2W, radial optics, stainless steel

Light planning by / IBF Project
Seafront promenade, Tribunj, Croatia

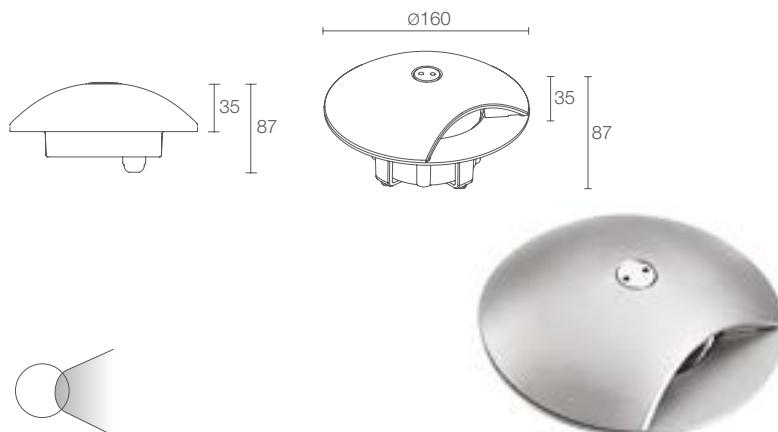

RONDÒ 3.1

Built-in power supply in version with 230Vac power



POWER / POWER SUPPLY CODE

- 3W 24Vdc
- RD3100** ■ H - Anthracite
- RD3100** ■ I - Stainless steel
- RD3100** ■ T - Cor-ten
- 3W 230Vac
- RD3110** ■ H Anthracite
- RD3110** ■ I Stainless steel
- RD3110** ■ T Cor-ten

LED COLOUR	F - 2700K 5 - 3000K 9 - 4000K
OPTICS	S - 10° A - radial
POWER CABLES	230Vac: includes 1.5 m neoprene cable H07RN-F 3x1.00 Ø8.7 mm 24Vdc: includes 1.5 m neoprene cable H05RN-F 2x0.35/0.75 Ø6.3 mm 1 - 5 m 2 - 10 m 3 - 15 m 4 - 20 m

LUMEN OUTPUT AT SOURCE	185 lm (3000K)
DELIVERED LUMEN OUTPUT	90 lm (3000K, radial optics)
NO. AND TYPE OF LED	1 power LED 1/4 ANSI BIN, 50000h L95 B10 (Ta 25°C)
MATERIAL	body in AISI 316L stainless steel screen in Rilsan® Clear
POWER SUPPLY UNIT	230Vac: built in 24Vdc: not included, see p. 904
MOUNTING	recessed (ground)
ACCESSORIES	see p. 405
PHOTOMETRIC DATA	see p. 872

▼
RONDÒ 3.4
3000K, 8W, radial, stainless steel
Light planning by / Cristian Turra
Private residence, Iseo, Brescia, Italy



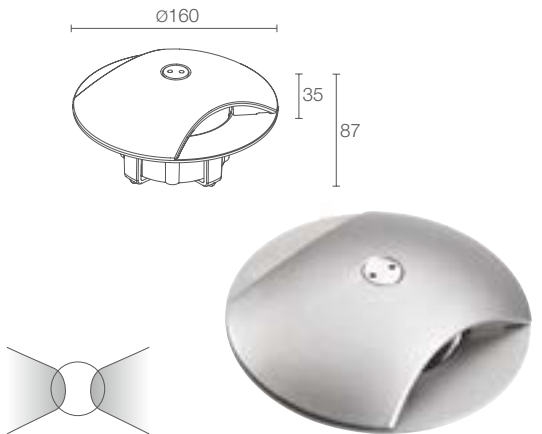

RONDÒ 3.2

Built-in power supply in version with 230Vac power

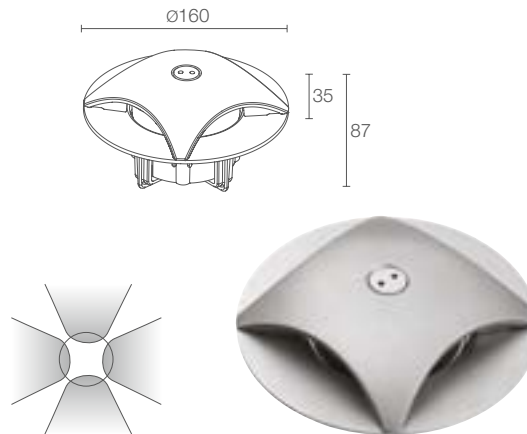

RONDÒ 3.4

Built-in power supply in version with 230Vac power



5W 24Vdc
RD3200 ■ ■ H - ■ Anthracite
RD3200 ■ ■ I - ■ Stainless steel
RD3200 ■ ■ T - ■ Cor-ten

5W 230Vac
RD3210 ■ ■ H Anthracite
RD3210 ■ ■ I Stainless steel
RD3210 ■ ■ T Cor-ten

■	F - 2700K 5 - 3000K 9 - 4000K
■	S - 10° A - radial
■	230Vac: includes 1.5 m neoprene cable H07RN-F 3x1.00 Ø8.7 mm 24Vdc: includes 1.5 m neoprene cable H05RN-F 2x0.35/0.75 Ø6.3 mm 1 - 5 m 2 - 10 m 3 - 15 m 4 - 20 m



8W 24Vdc
RD3400 ■ ■ H Anthracite
RD3400 ■ ■ I Stainless steel
RD3400 ■ ■ T Cor-ten

8W 230Vac
RD3410 ■ ■ H Anthracite
RD3410 ■ ■ I Stainless steel
RD3410 ■ ■ T Cor-ten

■	F - 2700K 5 - 3000K 9 - 4000K
■	S - 10° A - radial
■	230Vac: includes 1.5 m neoprene cable H07RN-F 3x1.00 Ø8.7 mm 24Vdc: includes 1.5 m neoprene cable H05RN-F 2x0.35/0.75 Ø6.3 mm

370 lm (3000K)
180 lm (3000K, radial optics)
2 power LEDs 1/4 ANSI BIN, 50000h L95 B10 (Ta 25°C)
body in AISI 316L stainless steel screen in Rilsan® Clear
230Vac: built in 24Vdc: not included, see p. 904
recessed (ground)
see p. 405
see p. 872

740 lm (3000K)
360 lm (3000K, radial optics)
4 power LEDs 1/4 ANSI BIN, 50000h L95 B10 (Ta 25°C)
body in AISI 316L stainless steel screen in Rilsan® Clear
230Vac: built in 24Vdc: not included, see p. 904
recessed (ground)
see p. 405
see p. 872





ACCESSORIES

ACCESSORIES FOR INSTALLATION



WC0100
Outer casing
(Rondò 1.1 / 1.2 / 2.1)



WC0103
Outer casing
(Rondò 1.1 / 1.2 / 2.1)



WC0150
Outer casing
(Rondò 1.1 / 1.2 / 2.1)



WC0601
Outer casing
(Rondò 3.1 / 3.2 / 3.4)



WC0701
Outer casing
(Rondò 3.1 / 3.2 / 3.4)

for spare parts, see p. 932

< **RONDÒ 1.2**
3000K, 4W, radial, stainless steel

Project by / Studio di Architettura Andrea Abbadessa,
ing. Ignazio Stancanelli, ing. Giuseppe Malatino
Light planning by / Light Style
Maniace-Ortigia, Syracuse, Italy



OUTDOOR STEP LIGHTS WALKWAY LIGHTING

2700K 3000K 4000K 5000K blue

CONSTANT CURRENT

CONSTANT VOLTAGE

RADIAL OPTICS ROUND COVER

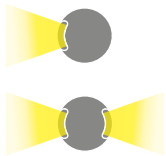

BEAM 2.0 p. 408
single beam: max 2W max 500mA
double beam: max 2W max 350mA



BEAM 2.6 p. 409
single beam, double beam: 2W 24Vdc

RADIAL OPTICS SQUARE COVER

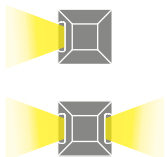

BEAM 2.1 p. 408
single beam: max 2W max 500mA
double beam: max 2W max 350mA



BEAM 2.7 p. 409
single beam, double beam: 2W 24Vdc

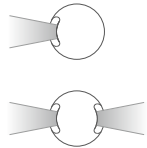
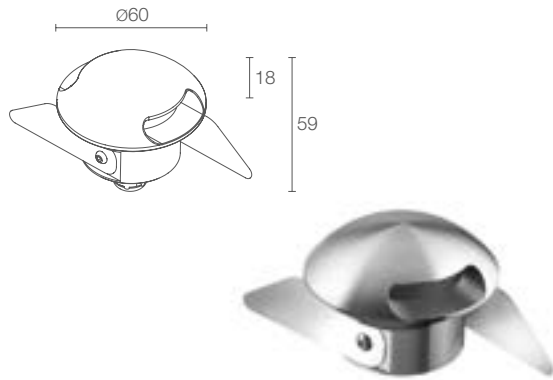

BEAM 2.0

Ø 80 mm
H 100 mm
Ø 45 mm

CE CB EAC LED TECH III

kg 0.25
kg 0.47 steel IP67 IK09

A A+ A++ IPS CASAMBI T max 60°C

POWER / POWER SUPPLY CODE

max 2W max 500mA single beam
CD2012 ■ **D A I** - ■ Stainless steel
CD2012 ■ **D A F** - ■ Grey
CD2012 ■ **D A H** - ■ Anthracite
 max 2W max 350mA double beam
CD2021 ■ **D A I** - ■ Stainless steel
CD2021 ■ **D A F** - ■ Grey
CD2021 ■ **D A H** - ■ Anthracite

LED COLOUR

F - 2700K
5 - 3000K
9 - 4000K
0 - 5000K
1 - blue

POWER CABLES

includes 1.5 m neoprene cable
 H05RN-F 2x0.35/0.75 Ø6.3 mm
1 - 5 m
2 - 10 m
3 - 15 m
4 - 20 m

OPTICS

radial

LUMEN OUTPUT AT SOURCE single beam: 145 lm (3000K, 500mA)
 double beam: 224 lm (3000K, 350mA)

DELIVERED LUMEN OUTPUT single beam: 70 lm (3000K, 500mA)
 double beam: 102 lm (3000K, 350mA)

NO. AND TYPE OF LED single beam: 1 power LED
 double beam: 2 power LEDs
 1/4 ANSI BIN (white LED colour)
 50000h L90 B10 (Ta 25°C)

MATERIAL body in stainless steel or anodized aluminium
 trim in stainless steel or aluminium
 screen in sandblasted plexiglass

POWER SUPPLY UNIT not included, see p. 904

WIRING series

MOUNTING recessed (wall, ground)

ACCESSORIES see p. 411

NOTES certified ETL version available on request

PHOTOMETRIC DATA see p. 781

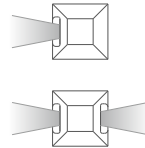
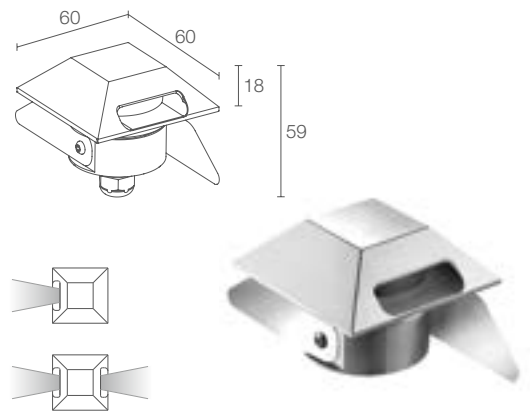

BEAM 2.1

Ø 80 mm
H 100 mm
Ø 45 mm

CE CB EAC LED TECH III

kg 0.25
kg 0.47 steel IP67 IK09

A A+ A++ IPS CASAMBI T max 60°C

max 2W max 500mA single beam
CD2112 ■ **D A I** - ■ Stainless steel
CD2112 ■ **D A F** - ■ Grey
CD2112 ■ **D A H** - ■ Anthracite
 max 2W max 350mA double beam
CD2121 ■ **D A I** - ■ Stainless steel
CD2121 ■ **D A F** - ■ Grey
CD2121 ■ **D A H** - ■ Anthracite

F - 2700K
5 - 3000K
9 - 4000K
0 - 5000K
1 - blue

includes 1.5 m neoprene cable
 H05RN-F 2x0.35/0.75 Ø6.3 mm
1 - 5 m
2 - 10 m
3 - 15 m
4 - 20 m

radial

LUMEN OUTPUT AT SOURCE single beam: 145 lm (3000K, 500mA)
 double beam: 224 lm (3000K, 350mA)

DELIVERED LUMEN OUTPUT single beam: 70 lm (3000K, 500mA)
 double beam: 102 lm (3000K, 350mA)

NO. AND TYPE OF LED single beam: 1 power LED
 double beam: 2 power LEDs
 1/4 ANSI BIN (white LED colour)
 50000h L90 B10 (Ta 25°C)

MATERIAL body in stainless steel or anodized aluminium
 trim in stainless steel or aluminium
 screen in sandblasted plexiglass

POWER SUPPLY UNIT not included, see p. 904

series

recessed (wall, ground)

see p. 411

certified ETL version available on request

see p. 781

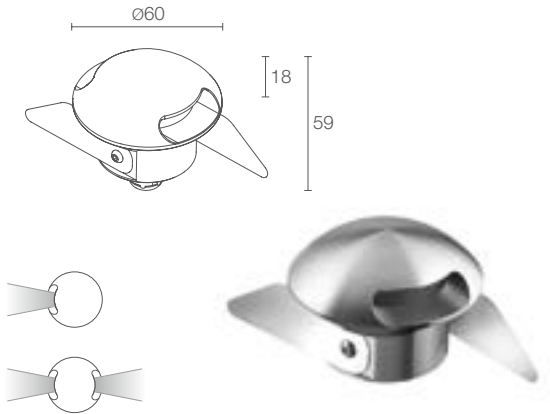

BEAM 2.6

Ø 80 mm
H 100 mm
Ø 45 mm

CE CB EAC LED TECH III

kg 0.25
kg 0.47 steel IP67 IK09

A A+ A++ IPS CASAMBI T max 60°C

2W 24Vdc single beam

CD2612 ■ **D I** - ■ Stainless steel
CD2612 ■ **D F** - ■ Grey
CD2612 ■ **D H** - ■ Anthracite

2W 24Vdc double beam

CD2621 ■ **D I** - ■ Stainless steel
CD2621 ■ **D F** - ■ Grey
CD2621 ■ **D H** - ■ Anthracite

■ **F** - 2700K
5 - 3000K
9 - 4000K
0 - 5000K
1 - blue

■ includes 1.5 m neoprene cable
H05RN-F 2x0.35/0.75 Ø6.3 mm
1 - 5 m
2 - 10 m
3 - 15 m
4 - 20 m

radial

single beam: 145 lm (3000K)
double beam: 224 lm (3000K)

single beam: 70 lm (3000K)
double beam: 102 lm (3000K)

single beam: 1 power LED
double beam: 2 power LEDs
1/4 ANSI BIN (white LED colour)
50000h L90 B10 (Ta 25°C)

body in stainless steel or anodized aluminium
trim in stainless steel or aluminium
screen in sandblasted plexiglass

not included, see p. 904

parallel

recessed (wall, ground)

see p. 411

certified ETL version available on request

see p. 781

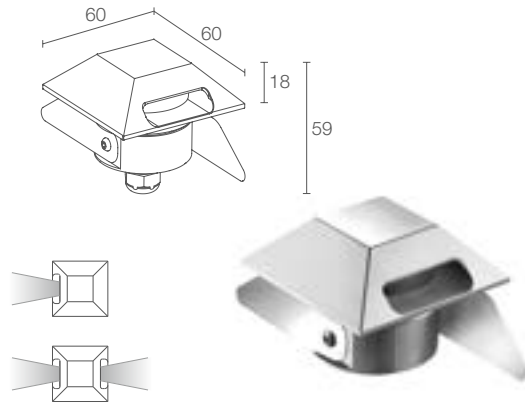

BEAM 2.7

Ø 80 mm
H 100 mm
Ø 45 mm

CE CB EAC LED TECH III

kg 0.25
kg 0.47 steel IP67 IK09

A A+ A++ IPS CASAMBI T max 60°C

2W 24Vdc single beam

CD2712 ■ **D I** - ■ Stainless steel
CD2712 ■ **D F** - ■ Grey
CD2712 ■ **D H** - ■ Anthracite

2W 24Vdc double beam

CD2721 ■ **D I** - ■ Stainless steel
CD2721 ■ **D F** - ■ Grey
CD2721 ■ **D H** - ■ Anthracite

■ **F** - 2700K
5 - 3000K
9 - 4000K
0 - 5000K
1 - blue

■ includes 1.5 m neoprene cable
H05RN-F 2x0.35/0.75 Ø6.3 mm
1 - 5 m
2 - 10 m
3 - 15 m
4 - 20 m

radial

single beam: 145 lm (3000K)
double beam: 224 lm (3000K)

single beam: 70 lm (3000K)
double beam: 102 lm (3000K)

single beam: 1 power LED
double beam: 2 power LEDs
1/4 ANSI BIN (white LED colour)
50000h L90 B10 (Ta 25°C)

body in stainless steel or anodized aluminium
trim in stainless steel or aluminium
screen in sandblasted plexiglass

not included, see p. 904

parallel

recessed (wall, ground)

see p. 411

certified ETL version available on request

see p. 781





ACCESSORIES

ACCESSORIES
FOR INSTALLATION**WC1501**

Outer casing

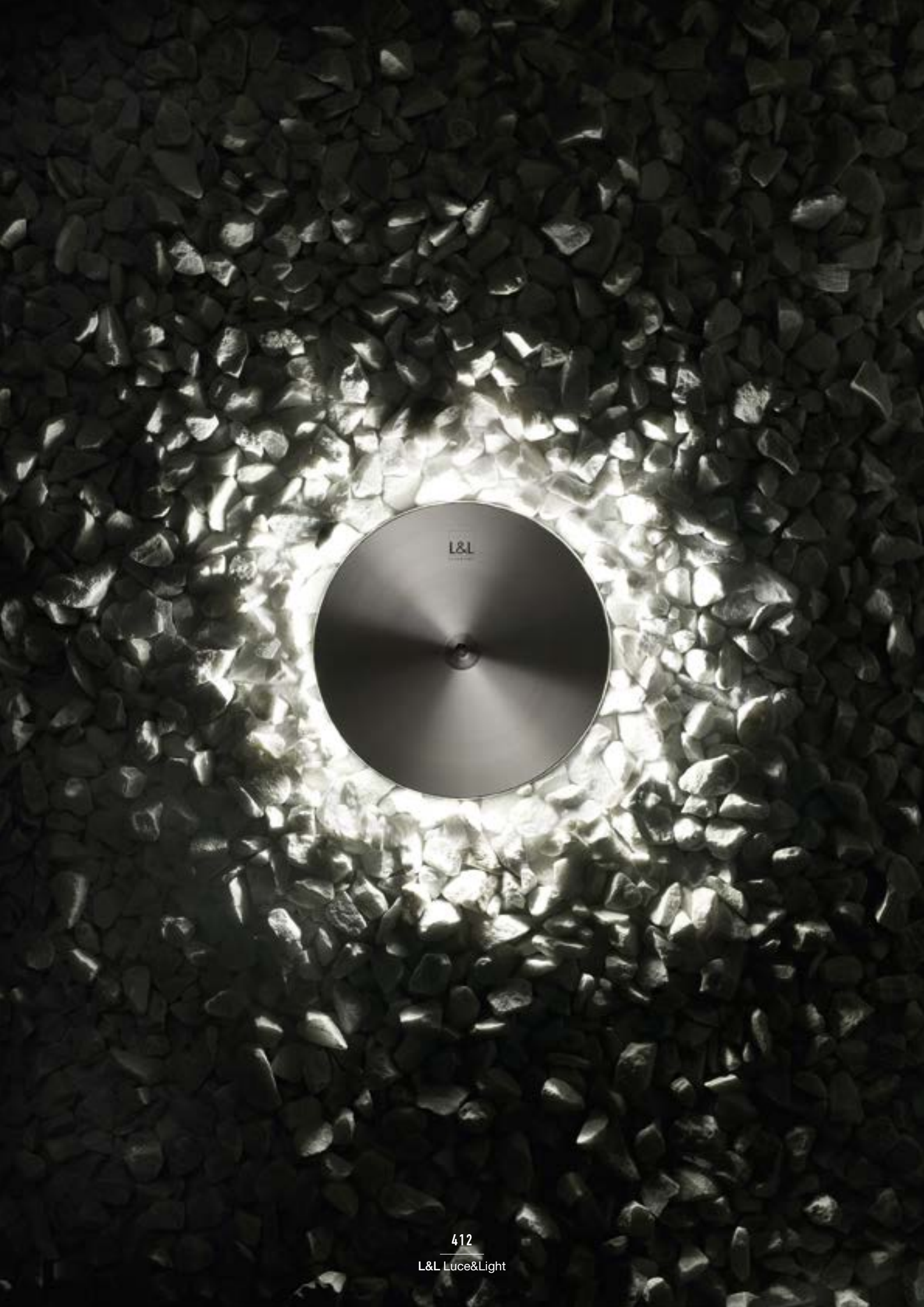

OUTDOOR STEP LIGHTS ORIENTATION LIGHTING

2700K 3000K 4000K blue

RADIAL OPTICS Ø39 mm

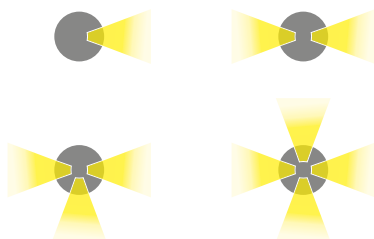

BRIGHT 1.A p. 415
max 2W max 700mA
constant current



BRIGHT 1.B p. 415
2.5W/3.5W 24Vdc
constant voltage

Ø78 mm



BRIGHT 4.7 p. 417
2W 24Vdc
constant voltage

Ø130 mm



BRIGHT 9.7 p. 417
4W 24Vdc
constant voltage



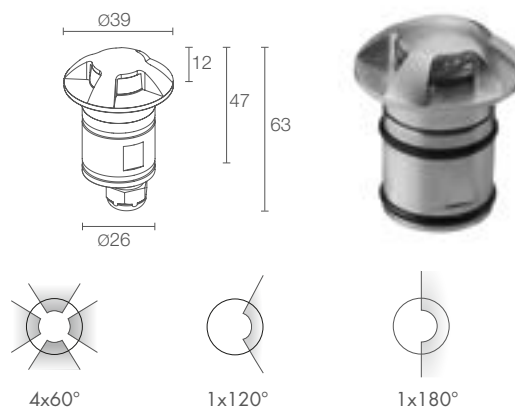
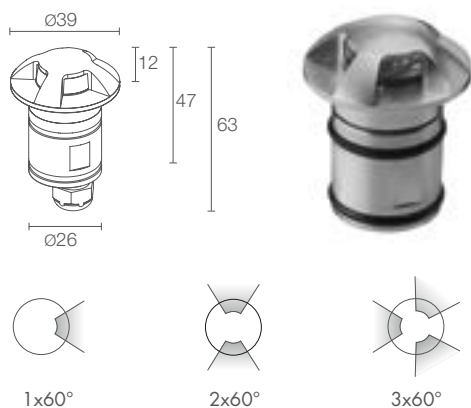

BRIGHT 1.A

Ø 80 mm
H 100 mm



kg 0.20 IP65 IP68 IK10

A A+ A++ IPS CASAMBI T max 50°C

POWER / POWER SUPPLY CODE

max 2W max 700mA
CB1A130 T I - Stainless steel

LED COLOUR	F - 2700K 5 - 3000K 9 - 4000K 1 - blue
BEAMS	R1 - 1x60° R2 - 2x60° R3 - 3x60° R4 - 4x60° R5 - 1x120° R6 - 1x180°
POWER CABLES	includes 1.5 m neoprene cable H05RN-F 2x0.35/0.75 Ø6.3 mm 1 - 5 m 2 - 10 m 3 - 15 m 4 - 20 m
OPTICS	radial

BRIGHT 1.B

Ø 80 mm
H 100 mm



kg 0.20 IP65 IP68 IK10

A A+ A++ IPS CASAMBI T max 50°C

2.5W 24Vdc
CB1B000 T I - Stainless steel

3.5W 24Vdc
CB1B010 T I - Stainless steel

LED COLOUR	F - 2700K 5 - 3000K 9 - 4000K 1 - blue
BEAMS	R1 - 1x60° R2 - 2x60° R3 - 3x60° R4 - 4x60° R5 - 1x120° R6 - 1x180°
POWER CABLES	includes 1.5 m neoprene cable H05RN-F 2x0.35/0.75 Ø6.3 mm 1 - 5 m 2 - 10 m 3 - 15 m 4 - 20 m
OPTICS	radial

LUMEN OUTPUT AT SOURCE	220 lm (3000K, 700mA)
DELIVERED LUMEN OUTPUT	56 lm (3000K, 700mA, 4x60°)
NO. AND TYPE OF LED	1 power LED 1/4 ANSI BIN (white LED colour) 50000h L90 B10 (Ta 25°C)
MATERIAL	body and trim in AISI 316L stainless steel
POWER SUPPLY UNIT	not included, see p. 904
WIRING	series
MOUNTING	recessed (wall, ground)
ACCESSORIES	see p. 419
PHOTOMETRIC DATA	see p. 802

LUMEN OUTPUT AT SOURCE	220 lm (3000K, 3.5W)
DELIVERED LUMEN OUTPUT	56 lm (3000K, 4x60°, 3.5W)
NO. AND TYPE OF LED	1 power LED 1/4 ANSI BIN (white LED colour) 50000h L90 B10 (Ta 25°C)
MATERIAL	body and trim in AISI 316L stainless steel
POWER SUPPLY UNIT	not included, see p. 904
WIRING	parallel
MOUNTING	recessed (wall, ground)
ACCESSORIES	see p. 419
PHOTOMETRIC DATA	see p. 802

< BRIGHT 1.B
3000K, 3.5W, 2x60°

Project by / arch. **Ciro Alfredo Matarante**
Photo by / **Alessio Tamborini**
Private residence, Foggia, Italy



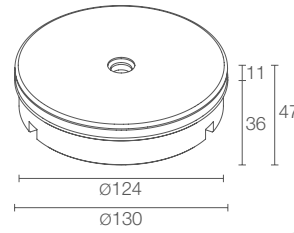
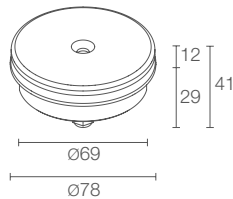

BRIGHT 4.7

Required outer casing, not included



POWER / POWER SUPPLY CODE	2W 24Vdc CB47000 ■ R I - ■
LED COLOUR	F - 2700K 5 - 3000K 9 - 4000K 1 - blue
POWER CABLES	includes 1.5 m neoprene cable H05RN-F 2x0.35/0.75 Ø6.3 mm 1 - 5 m 2 - 10 m 3 - 15 m 4 - 20 m
OPTICS	radial

LUMEN OUTPUT AT SOURCE	96 lm (3000K)
DELIVERED LUMEN OUTPUT	70 lm (3000K)
NO. AND TYPE OF LED	24 side-emitting LEDs 3-step MacAdam (white LED colour) 50000h L90 B10 (Ta 25°C)
MATERIAL	body in anodized aluminium trim in AISI 316L stainless steel screen in PMMA
POWER SUPPLY UNIT	not included, see p. 904
MOUNTING	recessed (ground)
ACCESSORIES	see p. 419
NOTES	not suitable for use in swimming pools or fountains underwater fixtures p. 728 tamper-resistant kit available on request
PHOTOMETRIC DATA	see p. 802

BRIGHT 9.7

Required outer casing, not included



POWER / POWER SUPPLY CODE	4W 24Vdc CB97000 ■ R I - ■
LED COLOUR	F - 2700K 5 - 3000K 9 - 4000K 1 - blue
POWER CABLES	includes 1.5 m neoprene cable H05RN-F 2x0.75/0.75 Ø6.3 mm 1 - 5 m 2 - 10 m 3 - 15 m 4 - 20 m
OPTICS	radial

LUMEN OUTPUT AT SOURCE	192 lm (3000K)
DELIVERED LUMEN OUTPUT	164 lm (3000K)
NO. AND TYPE OF LED	48 side-emitting LEDs 3-step MacAdam (white LED colour) 50000h L90 B10 (Ta 25°C)
MATERIAL	body in anodized aluminium trim in AISI 316L stainless steel screen in PMMA
POWER SUPPLY UNIT	not included, see p. 904
MOUNTING	recessed (ground)
ACCESSORIES	see p. 419
NOTES	tamper-resistant kit available on request
PHOTOMETRIC DATA	see p. 802

< **BRIGHT 9.7**
customized version
5000K, 9W

Project by / Dunsy Gindi
Light planning by / Ailon Gavish Studio Twilight
Photo by / Omri Amsalem
Villa, Caesarea, Israel

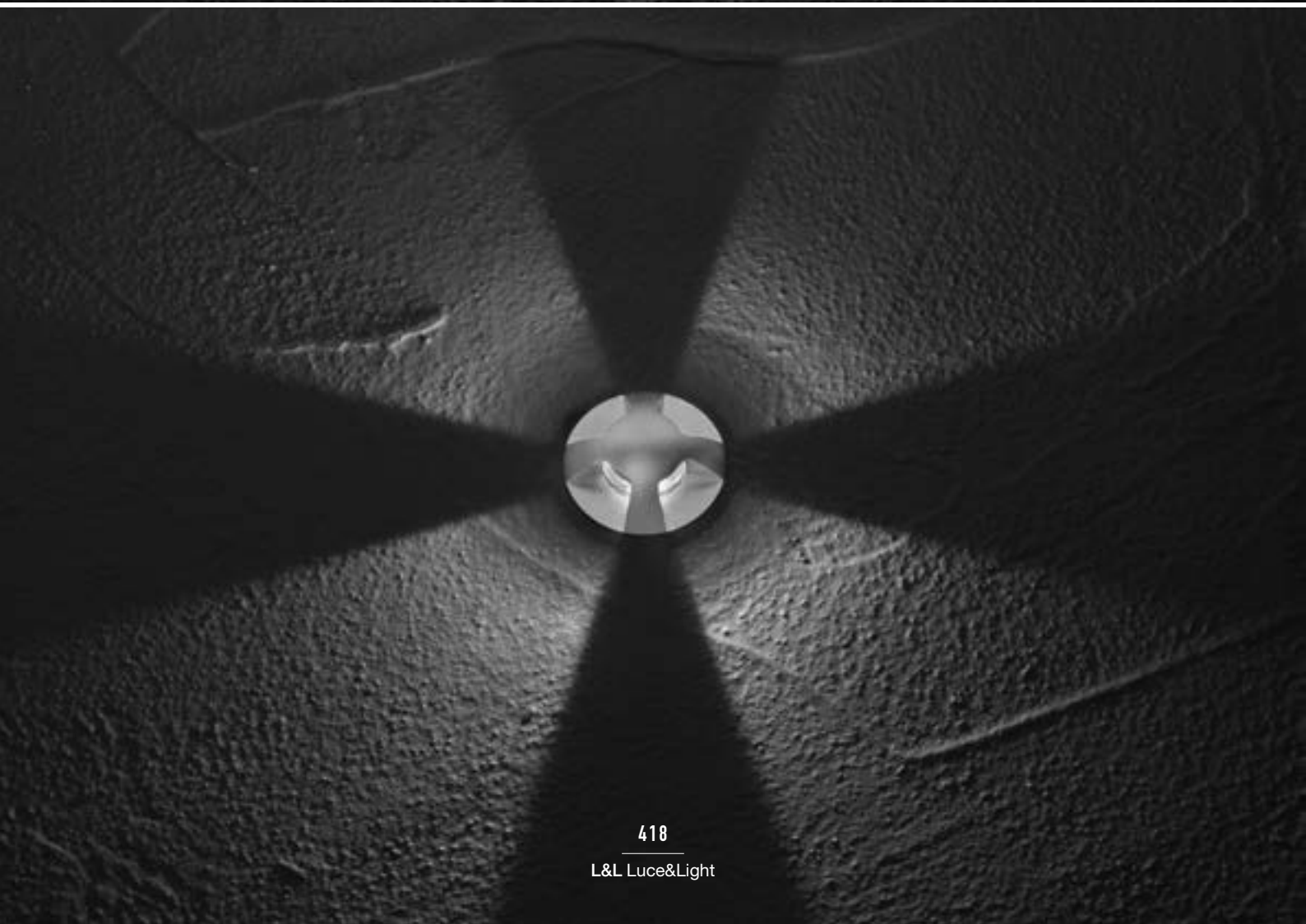

ACCESSORIES

ACCESSORIES FOR INSTALLATION



WC0202
Outer casing
(Bright 1.A / 1.B)



WC0100
Outer casing
(Bright 4.7)



WC0103
Outer casing
(Bright 4.7)



WC0150
Outer casing
(Bright 4.7)



WC0501
Outer casing
(Bright 9.7)



WC0601
Outer casing
(Bright 9.7)



WC0701
Outer casing
(Bright 9.7)

^ **BRIGHT 1.B**
4000K, 2.5W, 1°x180°

< **BRIGHT 1.B**
4000K, 2.5W, 4°x60°

OUTDOOR STEP LIGHTS WIDE SPACING BETWEEN FIXTURES ON PATHS



wide



asymmetrical



2700K



3000K



4000K

6W 230Vac
5W 24Vdc

8W/13W 230Vac
6W/8.5W 24Vdc

RECESSED, FLUSH

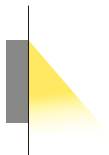

PASITO MINI 1.0 p. 424



PASITO 1.0 p. 426

RECESSED, WITH FRAME



PASITO MINI 1.1 p. 425



PASITO 1.1 p. 427

SURFACE MOUNTED



PASITO MINI 1.2 p. 425



PASITO 1.2 p. 427

RECESSED
INSTALLATION,
FLUSH: PASITO
DISAPPEARS
INTO THE WALL,
LEAVING ONLY
ITS LIGHT
OUTPUT VISIBLE



RECESSED
INSTALLATION, WITH
FRAME; SURFACE
INSTALLATION



IP65
SUITABLE FOR OUTDOOR APPLICATIONS



BUILT-IN PROTECTION SYSTEMS:
IPS
INTELLIGENT PROTECTION SYSTEM



IK05 PASITO MINI 1.0



IK06 PASITO MINI 1.1/1.2
PASITO 1.1/1.2



IK07 PASITO 1.0



BUILT-IN 230VAC POWER SUPPLY SO THAT THE FIXTURE
CAN BE CONNECTED DIRECTLY TO THE MAINS POWER
WITHOUT THE NEED FOR REMOTE DRIVERS



6-STEP MATERIAL PROTECTION, AND
OXIDATION AND CORROSION RESISTANCE

Low-copper-content anticorrosive aluminium alloy 6060

Preparation for painting

Epoxy paint

Polyester paint

Paints compliant with Qualicoat automotive coating standard

Salt spray tested (over 1500 hours)

BODY IN LOW-COPPER-CONTENT ANTICORRODAL 6060
ALUMINIUM FOR EXCELLENT RESISTANCE TO CORROSION
AND BETTER HEAT DISSIPATION. (PASITO MINI 1.0 AND PASITO 1.0)
BODY IN TECHNO-POLYMER FOR HIGH RESISTANCE
TO IMPACT, SUB-ZERO TEMPERATURES AND HARSH
CONDITIONS SUCH AS SALINE ENVIRONMENTS
(PASITO MINI 1.1 / 1.2 AND PASITO 1.1 / 1.2)

PASITO MINI 1.1 / PASITO 1.1

INSTALLED ON PLASTERBOARD USING THE SPRINGS PROVIDED,
WITHOUT THE NEED FOR AN OUTER CASING

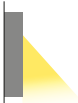

THE CONTROLLED DOWNWARD
BEAM REDUCES LIGHT
SPILL TO A MINIMUM

UNIQUE SELLING POINTS



RAL FINISH
ON REQUEST



ANTHRACITE



WHITE



CORTEN



GREY

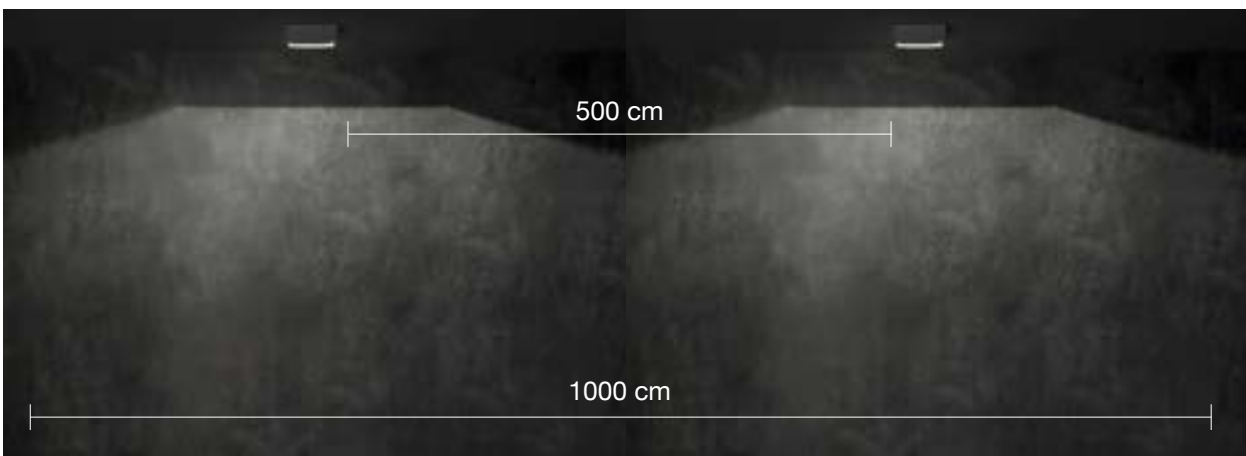

THE 150°X90° ASYMMETRICAL OPTICS MEAN THE FIXTURES CAN BE POSITIONED 5 METRES APART: THIS REDUCES THE NUMBER OF STEP LIGHTS NEEDED TO GUARANTEE LIGHT UNIFORMITY ON LONG PATHWAYS. INSTALLATION HEIGHT 80 CM.

- ▼ **PASITO MINI 1.0**
recessed installation, flush
- PASITO MINI 1.1**
recessed installation, with frame
- PASITO MINI 1.2**
surface installation

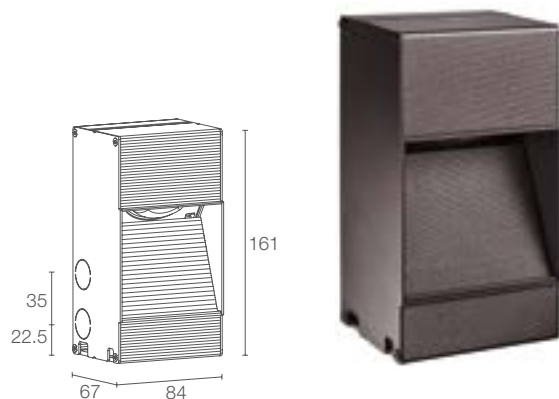

PASITO MINI 1.0

Power supply unit included in the 230Vac version
Required outer casing, not included



POWER / POWER SUPPLY CODE

6W 230Vac						
PM1010	000	0	0	0	E	White
PM1010	000	0	0	0	F	Grey
PM1010	000	0	0	0	H	Anthracite
PM1010	000	0	0	0	T	Cor-ten
5W 24Vdc						
PM1000	000	0	0	0	E	White
PM1000	000	0	0	0	F	Grey
PM1000	000	0	0	0	H	Anthracite
PM1000	000	0	0	0	T	Cor-ten

CRI	0 - CRI 80 1 - CRI >90
LED COLOUR	F - 2700K 5 - 3000K 9 - 4000K
OPTICS	A - asymmetrical, 150°x90° B - 60°

LUMEN OUTPUT AT SOURCE	383 lm (3000K, CRI 80)
DELIVERED LUMEN OUTPUT	214 lm (3000K, 150°x90°, CRI 80, white finish)
NO. AND TYPE OF LED	1 high-intensity power LED 1/4 ANSI BIN, 50000h L90 B10 (Ta 25°C)
MATERIAL	body in anticorodal aluminium
POWER SUPPLY UNIT	230Vac: included 24Vdc: not included, see p. 904
POWER CABLES	230Vac: includes 0.20 m neoprene cable H05RN-F 2x1.00 Ø7.0 mm 24Vdc: includes 0.30 m neoprene cable H05RN-F 2x0.35/0.75 Ø6.3 mm
MOUNTING	recessed, flush (wall)
ACCESSORIES	see p. 429
PHOTOMETRIC DATA	see p. 858

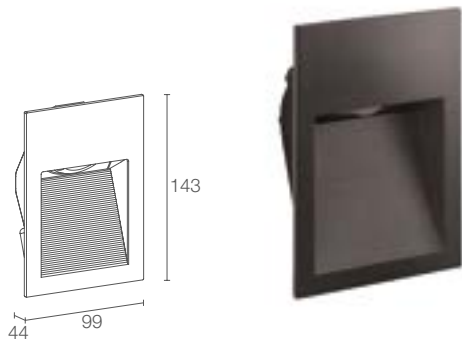

85x125 mm

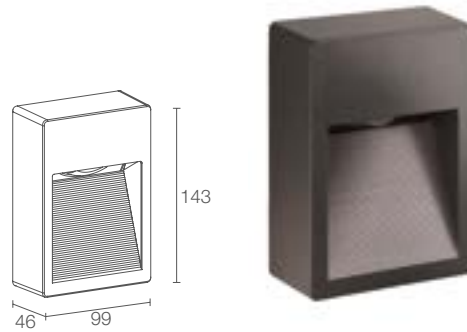

PASITO MINI 1.1

Power supply unit included in the 230Vac version



- 6W 230Vac
- PM1110 E White
 - PM1110 F Grey
 - PM1110 H Anthracite
 - PM1110 T Cor-ten

- 5W 24Vdc
- PM1100 E White
 - PM1100 F Grey
 - PM1100 H Anthracite
 - PM1100 T Cor-ten

0 - CRI 80
1 - CRI >90
F - 2700K
5 - 3000K
9 - 4000K
A - asymmetrical, 150°x90°
B - 60°

383 lm (3000K, CRI 80)

214 lm (3000K, 150°x90°, CRI 80, white finish)

1 high-intensity power LED
1/4 ANSI BIN, 50000h L90 B10 (Ta 25°C)

body in technopolymer and aluminium

230Vac: included
24Vdc: not included, see p. 904

230Vac: includes 0.20 m neoprene cable
H05RN-F 2x1.00 Ø7.0 mm
24Vdc: includes 0.30 m neoprene cable
H05RN-F 2x0.35/0.75 Ø6.3 mm

recessed, with frame (wall)

see p. 429

see p. 858

PASITO MINI 1.2

Power supply unit included in the 230Vac version



- 6W 230Vac
- PM1210 E White
 - PM1210 F Grey
 - PM1210 H Anthracite
 - PM1210 T Cor-ten

- 5W 24Vdc
- PM1200 E White
 - PM1200 F Grey
 - PM1200 H Anthracite
 - PM1200 T Cor-ten

0 - CRI 80
1 - CRI >90
F - 2700K
5 - 3000K
9 - 4000K
A - asymmetrical, 150°x90°
B - 60°

383 lm (3000K, CRI 80)

214 lm (3000K, 150°x90°, CRI 80, white finish)

1 high-intensity power LED
1/4 ANSI BIN, 50000h L90 B10 (Ta 25°C)

body in technopolymer and aluminium

230Vac: included
24Vdc: not included, see p. 904

230Vac: includes 0.20 m neoprene cable
H05RN-F 2x1.00 Ø7.0 mm
24Vdc: includes 0.30 m neoprene cable
H05RN-F 2x0.35/0.75 Ø6.3 mm

surface mounted (wall)

none

see p. 858





- ✓ PASITO 1.0
recessed installation, flush
- PASITO 1.1
recessed installation, with frame
- PASITO 1.2
surface installation

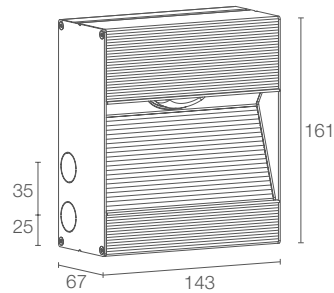
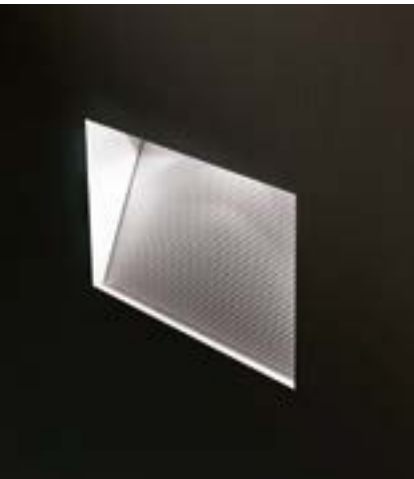

PASITO 1.0

Power supply unit included in the 230Vac version
Required outer casing, not included



POWER / POWER SUPPLY CODE

13W 230Vac					
PA1010	■	■	■	■	E White
PA1010	■	■	■	■	F Grey
PA1010	■	■	■	■	H Anthracite
PA1010	■	■	■	■	T Cor-ten
8.5W 24Vdc					
PA1000	■	■	■	■	E White
PA1000	■	■	■	■	F Grey
PA1000	■	■	■	■	H Anthracite
PA1000	■	■	■	■	T Cor-ten

■ CRI	0 - CRI 80 1 - CRI >90
■ LED COLOUR	F - 2700K 5 - 3000K 9 - 4000K
■ OPTICS	A - asymmetrical, 150°x90° B - 60°

LUMEN OUTPUT AT SOURCE	851 lm (3000K, CRI 80)
DELIVERED LUMEN OUTPUT	390 lm (3000K, 150°x90°, CRI 80, white finish)
NO. AND TYPE OF LED	1 high-intensity power LED 3-step MacAdam, 50000h L90 B10 (Ta 25°C)
MATERIAL	body in anticorodal aluminium
POWER SUPPLY UNIT	230Vac: included 24Vdc: not included, see p. 904
POWER CABLES	230Vac: includes 0.20 m neoprene cable H05RN-F 2x1.00 Ø7.0 mm 24Vdc: includes 0.30 m neoprene cable H05RN-F 2x0.35/0.75 Ø6.3 mm
MOUNTING	recessed, flush (wall)
ACCESSORIES	see p. 429
PHOTOMETRIC DATA	see p. 858 and 859

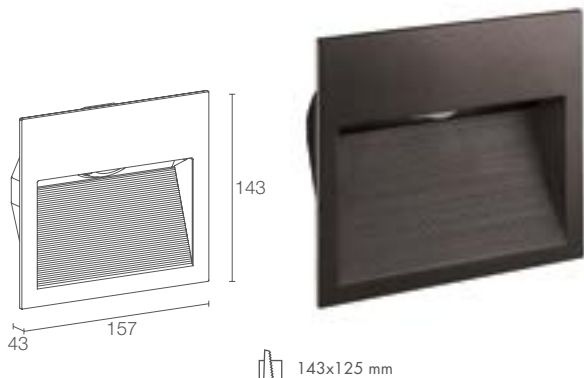

143x125 mm

PASITO 1.1

Power supply unit included in the 230Vac version



kg 0.46 IP65 IK06



8W 230Vac

PA1110 **E** White
PA1110 **F** Grey
PA1110 **H** Anthracite
PA1110 **T** Cor-ten

6W 24Vdc

PA1100 **E** White
PA1100 **F** Grey
PA1100 **H** Anthracite
PA1100 **T** Cor-ten

	0 - CRI 80 1 - CRI >90
	F - 2700K 5 - 3000K 9 - 4000K
	A - asymmetrical, 150°x90° B - 60°

851 lm (3000K, CRI 80)

364 lm (3000K, 150°x90°, CRI 80, white finish)

1 high-intensity power LED
3-step MacAdam, 50000h L90 B10 (Ta 25°C)

body in technopolymer and aluminium

230Vac: included
24Vdc: not included, see p. 904

230Vac: includes 0.20 m neoprene cable
H05RN-F 2x1.00 Ø7.0 mm
24Vdc: includes 0.30 m neoprene cable
H05RN-F 2x0.35/0.75 Ø6.3 mm

recessed, with frame (wall)

see p. 429

see p. 859

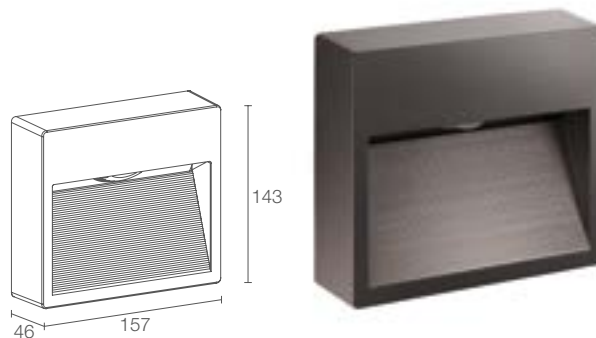

143x125 mm

PASITO 1.2

Power supply unit included in the 230Vac version



kg 0.60 IP65 IK06



8W 230Vac

PA1210 **E** White
PA1210 **F** Grey
PA1210 **H** Anthracite
PA1210 **T** Cor-ten

6W 24Vdc

PA1200 **E** White
PA1200 **F** Grey
PA1200 **H** Anthracite
PA1200 **T** Cor-ten

	0 - CRI 80 1 - CRI >90
	F - 2700K 5 - 3000K 9 - 4000K
	A - asymmetrical, 150°x90° B - 60°

851 lm (3000K, CRI 80)

364 lm (3000K, 150°x90°, CRI 80, white finish)

1 high-intensity power LED
3-step MacAdam, 50000h L90 B10 (Ta 25°C)

body in technopolymer and aluminium

230Vac: included
24Vdc: not included, see p. 904

230Vac: includes 0.20 m neoprene cable
H05RN-F 2x1.00 Ø7.0 mm
24Vdc: includes 0.30 m neoprene cable
H05RN-F 2x0.35/0.75 Ø6.3 mm

surface mounted (wall)

none

see p. 859

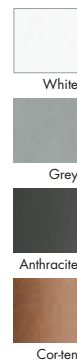

**POSITIONING
DIAGRAMS**

PASITO MINI 1.0 / 1.1 / 1.2

A - Asymmetrical 150°x90°

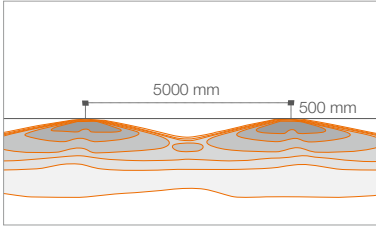

B - 60°

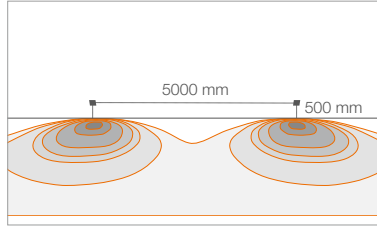

A - Asymmetrical 150°x90°

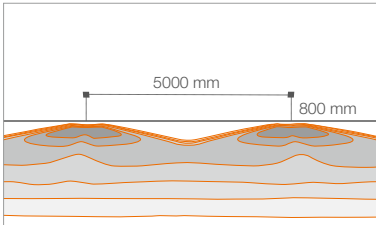

B - 60°

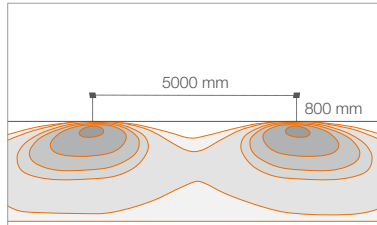

PASITO 1.0 / 1.1 / 1.2

A - Asymmetrical 150°x90°

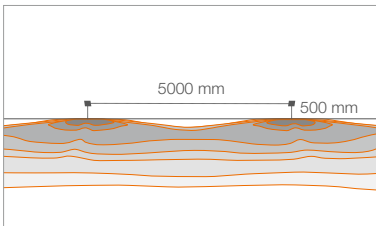

B - 60°

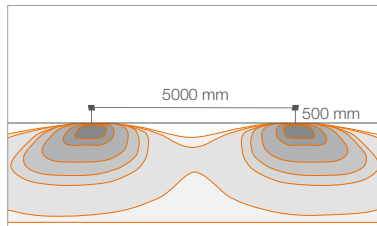

A - Asymmetrical 150°x90°

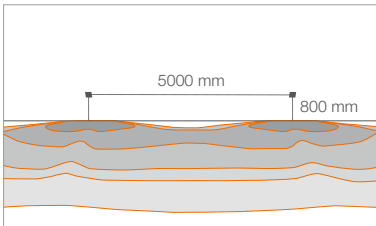

B - 60°

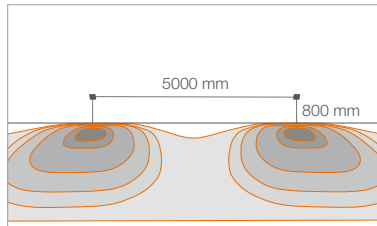

ACCESSORIES AND POSITIONING DIAGRAMS

ACCESSORIES FOR INSTALLATION

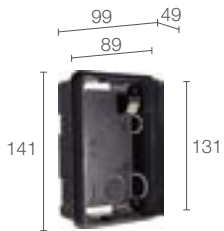

WC1420

Outer casing for solid walls
(Pasito Mini 1.1)



WC1430

Outer casing for solid walls
(Pasito 1.1)

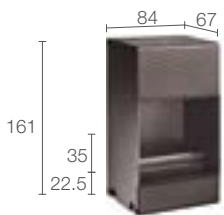

WCA00E - White

WCA00F - Grey

WCA00H - Anthracite

WCA00T - Cor-ten

Outer casing

(Pasito Mini 1.0)

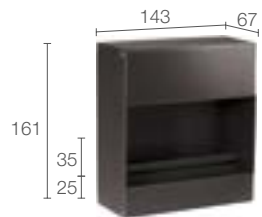

WC1410E - White

WC1410F - Grey

WC1410H - Anthracite

WC1410T - Cor-ten

Outer casing

(Pasito 1.0)



< **STEP OUTSIDE 5.2**
3000K, 2W, customized version
with anthracite finish

Project by / arch. Fernanda Cantone
Light planning by / Light Style
Castello Tafuri Charming Suites
Portopalo di Capo Passero, Syracuse, Italy

SQUARE COVER

SEMI-RECESSED

2700K 3000K 4000K 5000K blue

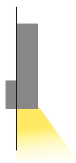

STEP OUTSIDE 2.0 p. 432
max 2W max 500mA
constant current



STEP OUTSIDE 2.6 p. 433
2W 24Vdc
constant voltage

RECESSED

2700K 3000K 4000K 5000K blue

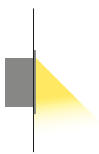

STEP OUTSIDE 6.1 p. 436
max 2W max 500mA
constant current



STEP OUTSIDE 6.2 p. 437
max 2W max 500mA
constant current



STEP OUTSIDE 6.3 p. 437
max 2W max 500mA
constant current

SURFACE MOUNTED

3000K 4000K 5000K

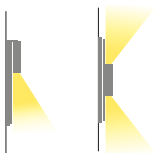

STEP OUTSIDE 7.0 p. 439
3.5W 24Vdc
constant voltage



STEP OUTSIDE 8.0 p. 439
3.5W 24Vdc
constant voltage

INDOOR

STEP INSIDE 2 p. 704

STEP OUTSIDE

OUTDOOR STEP LIGHTS ORIENTATION LIGHT AND LIGHTING FOR WALKWAYS AND STEPS

ROUND COVER

SEMI-RECESSED

2700K 3000K 4000K 5000K blue

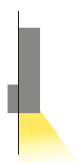

diffuse



STEP OUTSIDE 2.1 p. 432
max 2W max 500mA
constant current



STEP OUTSIDE 2.7 p. 433
2W 24Vdc
constant voltage

RECESSED

2700K 3000K 4000K 5000K blue

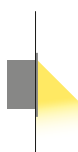

asymmetrical



STEP OUTSIDE 5.1 p. 435
max 2W max 500mA
constant current



STEP OUTSIDE 5.2 p. 435
max 2W max 500mA
constant current

INDOOR

STEP INSIDE 2 p. 704

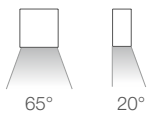
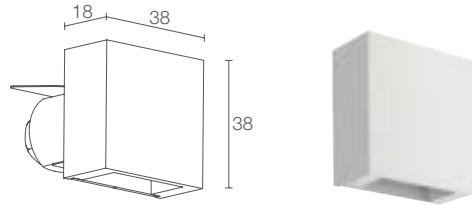

STEP OUTSIDE 2.0



POWER / POWER SUPPLY CODE

max 2W max 500mA
SP2012 ■ **DAE** - ■ White
SP2012 ■ **DAN** - ■ Black
SP2012 ■ **DAT** - ■ Cor-ten

LED COLOUR

F - 2700K
5 - 3000K
9 - 4000K
0 - 5000K
1 - blue

POWER CABLES

includes 1.5 m neoprene cable
 H05RN-F 2x0.35/0.75 Ø6.3 mm
1 - 5 m
2 - 10 m
3 - 15 m
4 - 20 m

OPTICS

diffuse

LUMEN OUTPUT AT SOURCE 145 lm (3000K, 500mA)

DELIVERED LUMEN OUTPUT 35 lm (3000K, 500mA)

NO. AND TYPE OF LED 1 power LED
 1/4 ANSI BIN (white LED colour)
 50000h L90 B10 (Ta 25°C)

MATERIAL body and cover in aluminium
 screen in transparent extra-clear glass

POWER SUPPLY UNIT not included, see p. 904

WIRING series

MOUNTING semi-recessed (wall)

ACCESSORIES see p. 441

NOTES indoor version: Step Inside 2.2, p. 706
 certified ETL version available on request

PHOTOMETRIC DATA see p. 885

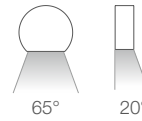
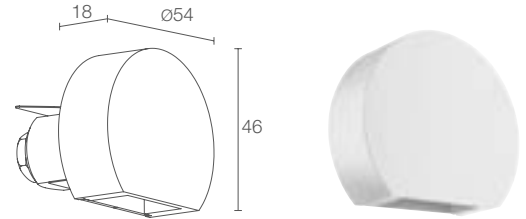

STEP OUTSIDE 2.1



max 2W max 500mA
SP2112 ■ **DAE** - ■ White
SP2112 ■ **DAN** - ■ Black
SP2112 ■ **DAT** - ■ Cor-ten

F - 2700K
5 - 3000K
9 - 4000K
0 - 5000K
1 - blue

includes 1.5 m neoprene cable
 H05RN-F 2x0.35/0.75 Ø6.3 mm
1 - 5 m
2 - 10 m
3 - 15 m
4 - 20 m

diffuse

LUMEN OUTPUT AT SOURCE 145 lm (3000K, 500mA)

DELIVERED LUMEN OUTPUT 35 lm (3000K, 500mA)

NO. AND TYPE OF LED 1 power LED
 1/4 ANSI BIN (white LED colour)
 50000h L90 B10 (Ta 25°C)

MATERIAL body and cover in aluminium
 screen in transparent extra-clear glass

POWER SUPPLY UNIT not included, see p. 904

WIRING series

MOUNTING semi-recessed (wall)

ACCESSORIES see p. 441

NOTES indoor version: Step Inside 2.3, p. 706
 certified ETL version available on request

PHOTOMETRIC DATA see p. 885

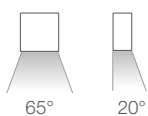
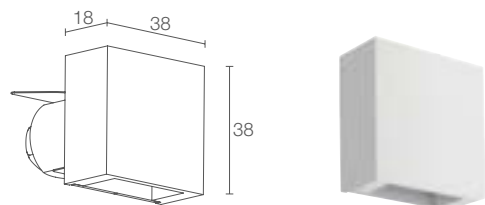

STEP OUTSIDE 2.6



2W 24Vdc

SP2600 **D E** - ■ White
SP2600 **D N** - ■ Black
SP2600 **D T** - ■ Cor-ten

■	F - 2700K 5 - 3000K 9 - 4000K 0 - 5000K 1 - blue
■	includes 1.5 m neoprene cable H05RN-F 2x0.35/0.75 Ø6.3 mm 1 - 5 m 2 - 10 m 3 - 15 m 4 - 20 m

diffuse

145 lm (3000K)

35 lm (3000K)

1 power LED
1/4 ANSI BIN (white LED colour)
50000h L90 B10 (Ta 25°C)

body and cover in aluminium
screen in transparent extra-clear glass

not included, see p. 904

parallel

semi-recessed (wall)

see p. 441

indoor version: Step Inside 2.8, p. 707
certified ETL version available on request

see p. 885

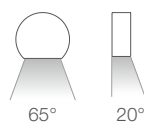
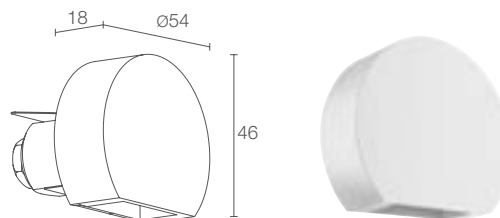

STEP OUTSIDE 2.7



2W 24Vdc

SP2700 **D E** - ■ White
SP2700 **D N** - ■ Black
SP2700 **D T** - ■ Cor-ten

■	F - 2700K 5 - 3000K 9 - 4000K 0 - 5000K 1 - blue
■	includes 1.5 m neoprene cable H05RN-F 2x0.35/0.75 Ø6.3 mm 1 - 5 m 2 - 10 m 3 - 15 m 4 - 20 m

diffuse

145 lm (3000K)

35 lm (3000K)

1 power LED
1/4 ANSI BIN (white LED colour)
50000h L90 B10 (Ta 25°C)

body and cover in aluminium
screen in transparent extra-clear glass

not included, see p. 904

parallel

semi-recessed (wall)

see p. 441

indoor version: Step Inside 2.9, p. 707
certified ETL version available on request

see p. 885





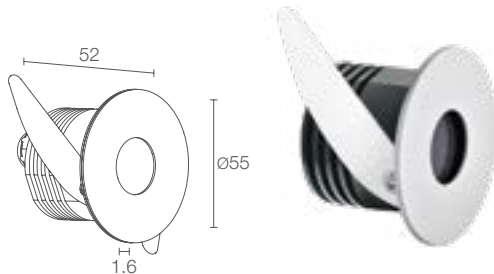

STEP OUTSIDE 5.1

Ø 70 mm
H 90 mm

Ø 45 mm

CE ENEC LED TECH III kg 0.24 IP65
A A+ A++ IPS CASAMBI

POWER / POWER SUPPLY CODE

max 2W max 500mA
SP5112 **AAE** - White
SP5112 **AA S** - Satin
SP5112 **AA N-** Black
SP5112 **AA T** - Cor-ten

LED COLOUR

F - 2700K
5 - 3000K
9 - 4000K
0 - 5000K
1 - blue

POWER CABLES

includes 1.5 m neoprene cable
 H05RN-F 2x0.35/0.75 Ø6.3 mm
1 - 5 m
2 - 10 m
3 - 15 m
4 - 20 m

OPTICS

asymmetrical

LUMEN OUTPUT AT SOURCE 145 lm (3000K, 500mA)

DELIVERED LUMEN OUTPUT 34 lm (3000K, 500mA)

NO. AND TYPE OF LED 1 power LED
 1/4 ANSI BIN (white LED colour)
 50000h L90 B10 (Ta 25°C)

MATERIAL body in aluminium, cover in stainless steel
 screen in transparent plexiglass

POWER SUPPLY UNIT not included, see p. 904

WIRING series

MOUNTING recessed (wall)

ACCESSORIES see p. 441

NOTES certified ETL version available on request

PHOTOMETRIC DATA see p. 885

STEP OUTSIDE 5.2

Ø 70 mm
H 90 mm

Ø 45 mm

CE ENEC LED TECH III kg 0.24 IP65
A A+ A++ IPS CASAMBI

max 2W max 500mA
SP5212 **AAE** - White
SP5212 **AA S** - Satin
SP5212 **AA N-** Black
SP5212 **AA T** - Cor-ten

F - 2700K
5 - 3000K
9 - 4000K
0 - 5000K
1 - blue

includes 1.5 m neoprene cable
 H05RN-F 2x0.35/0.75 Ø6.3 mm
1 - 5 m
2 - 10 m
3 - 15 m
4 - 20 m

asymmetrical

145 lm (3000K, 500mA)

42 lm (3000K, 500mA)

1 power LED
 1/4 ANSI BIN (white LED colour)
 50000h L90 B10 (Ta 25°C)

body in aluminium, cover in stainless steel
 screen in transparent plexiglass

not included, see p. 904

series

recessed (wall)

see p. 441

certified ETL version available on request

see p. 885

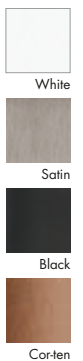

< STEP OUTSIDE 5.2

3000K, 2W, customized version
 with anthracite finish

Project by / arch. Fernanda Cantone
 Light planning by / Light Style
 Castello Tafuri Charming Suites
 Portopalo di Capo Passero, Syracuse, Italy

✓
STEP OUTSIDE 6.3
 3000K, 2W, satin
SPOT 1.0
 3000K, 2W, 20°

Private residence, Positano, Salerno, Italy

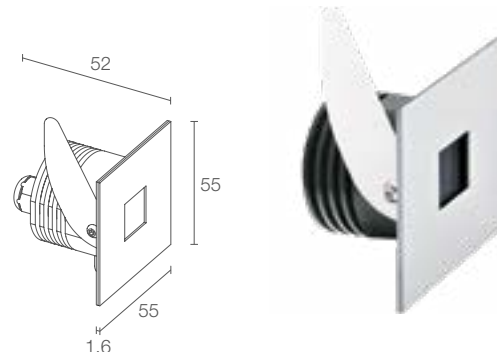

STEP OUTSIDE 6.1

Ø 70 mm
 H 90 mm

Ø 45 mm

kg 0.24 IP65
 CASAMBI

POWER / POWER SUPPLY CODE

max 2W max 500mA
SP6112 **A A E** - White
SP6112 **A A S** - Satin
SP6112 **A A N** - Black
SP6112 **A A T** - Cor-ten

LED COLOUR

F - 2700K
5 - 3000K
9 - 4000K
0 - 5000K
1 - blue

POWER CABLES

includes 1.5 m neoprene cable
 H05RN-F 2x0.35/0.75 Ø6.3 mm
1 - 5 m
2 - 10 m
3 - 15 m
4 - 20 m

OPTICS

asymmetrical

LUMEN OUTPUT AT SOURCE

145 lm (3000K, 500mA)

DELIVERED LUMEN OUTPUT

29 lm (3000K, 500mA)

NO. AND TYPE OF LED

1 power LED
 1/4 ANSI BIN (white LED colour)
 50000h L90 B10 (Ta 25°C)

MATERIAL

body in aluminium, cover in stainless steel
screen in transparent plexiglass

POWER SUPPLY UNIT

not included, see p. 904

WIRING

series

MOUNTING

recessed (wall)

ACCESSORIES

see p. 441

NOTES

certified ETL version available on request

PHOTOMETRIC DATA

see p. 885

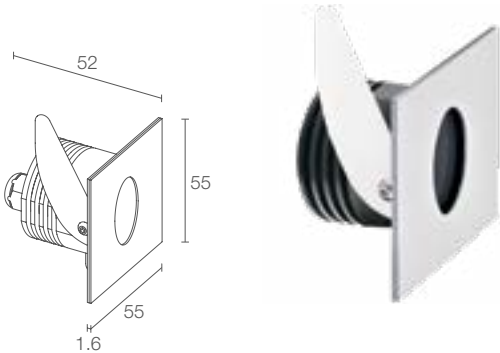

STEP OUTSIDE 6.2



max 2W max 500mA
SP6212 ■ **A A E** - ■ White
SP6212 ■ **A A S** - ■ Satin
SP6212 ■ **A A N** - ■ Black
SP6212 ■ **A A T** - ■ Cor-ten

■ **F** - 2700K
5 - 3000K
9 - 4000K
0 - 5000K
1 - blue

■ includes 1.5 m neoprene cable
H05RN-F 2x0.35/0.75 Ø6.3 mm
1 - 5 m
2 - 10 m
3 - 15 m
4 - 20 m

asymmetrical

145 lm (3000K, 500mA)

42 lm (3000K, 500mA)

1 power LED
1/4 ANSI BIN (white LED colour)
50000h L90 B10 (Ta 25°C)

body in aluminium, cover in stainless steel
screen in transparent plexiglass

not included, see p. 904

series

recessed (wall)

see p. 441

certified ETL version available on request

see p. 885

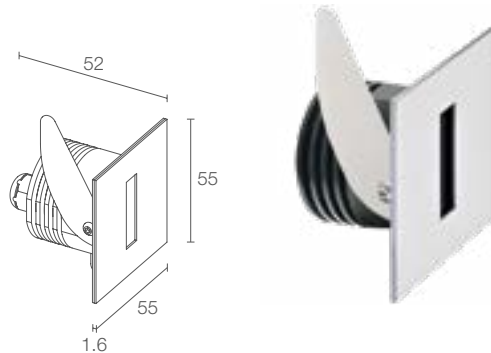

STEP OUTSIDE 6.3

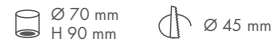

max 2W max 500mA
SP6312 ■ **A A E** - ■ White
SP6312 ■ **A A S** - ■ Satin
SP6312 ■ **A A N** - ■ Black
SP6312 ■ **A A T** - ■ Cor-ten

■ **F** - 2700K
5 - 3000K
9 - 4000K
0 - 5000K
1 - blue

■ includes 1.5 m neoprene cable
H05RN-F 2x0.35/0.75 Ø6.3 mm
1 - 5 m
2 - 10 m
3 - 15 m
4 - 20 m

asymmetrical

145 lm (3000K, 500mA)

25 lm (3000K, 500mA)

1 power LED
1/4 ANSI BIN (white LED colour)
50000h L90 B10 (Ta 25°C)

body in aluminium, cover in stainless steel
screen in transparent plexiglass

not included, see p. 904

series

recessed (wall)

see p. 441

certified ETL version available on request

see p. 885

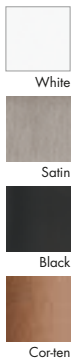



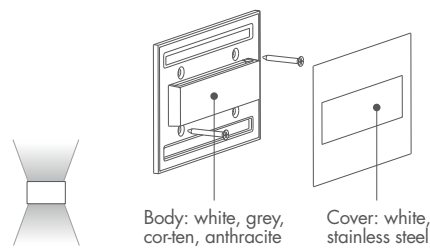
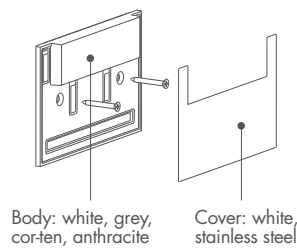
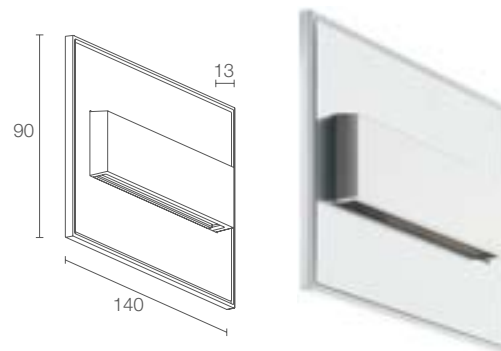
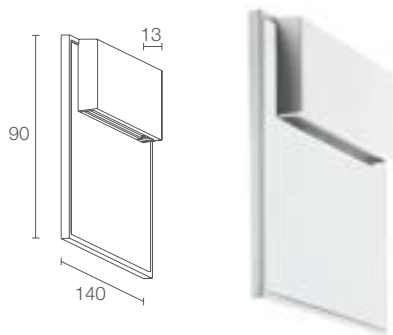

STEP OUTSIDE 7.0



POWER / POWER SUPPLY CODE	3.5W 24Vdc
	SP7000 ■ A W White - White
	SP7000 ■ A E White - Stainless steel
	SP7000 ■ A F Grey - Stainless steel
	SP7000 ■ A H Anthracite - Stainless steel
SP7000 ■ A T Cor-ten - Stainless steel	

LED COLOUR	5 - 3000K 9 - 4000K 0 - 5000K
-------------------	--

OPTICS	diffuse
---------------	---------

LUMEN OUTPUT AT SOURCE	107 lm (3000K)
DELIVERED LUMEN OUTPUT	56 lm (3000K)
NO. AND TYPE OF LED	1 power LED 1/4 ANSI BIN, 50000h L90 B10 (Ta 25°C)
MATERIAL	body in die-cast aluminium screen in transparent polycarbonate
POWER SUPPLY UNIT	not included, see p. 904
POWER CABLES	includes 2x0.30 m single-core cables
MOUNTING	surface mounted (wall)
ACCESSORIES	see p. 441
NOTES	certified ETL version available on request
PHOTOMETRIC DATA	see p. 886

STEP OUTSIDE 8.0



POWER / POWER SUPPLY CODE	3.5W 24Vdc
	SP8000 ■ A W White - White
	SP8000 ■ A E White - Stainless steel
	SP8000 ■ A F Grey - Stainless steel
	SP8000 ■ A H Anthracite - Stainless steel
SP8000 ■ A T Cor-ten - Stainless steel	

LED COLOUR	5 - 3000K 9 - 4000K 0 - 5000K
-------------------	--

OPTICS	diffuse
---------------	---------

LUMEN OUTPUT AT SOURCE	214 lm (3000K)
DELIVERED LUMEN OUTPUT	16 lm (3000K)
NO. AND TYPE OF LED	1 power LED 1/4 ANSI BIN, 50000h L90 B10 (Ta 25°C)
MATERIAL	body in die-cast aluminium screen in transparent polycarbonate
POWER SUPPLY UNIT	not included, see p. 904
POWER CABLES	includes 2x0.30 m single-core cables
MOUNTING	surface mounted (wall)
ACCESSORIES	see p. 441
NOTES	certified ETL version available on request
PHOTOMETRIC DATA	see p. 886





ACCESSORIES

ACCESSORIES FOR INSTALLATION



WC0202
Outer casing
(Step Outside 2.0 /
2.1 / 2.6 / 2.7)



WC1501
Outer casing
(Step Outside 5.1 / 5.2 /
6.1 / 6.2 / 6.3)



WC0301
Optional outer casing
(Step Outside 7.0 / 8.0)

POSITIONING DIAGRAMS

STEP OUTSIDE 2.0 / 2.1 / 2.6 / 2.7

D - Diffuse

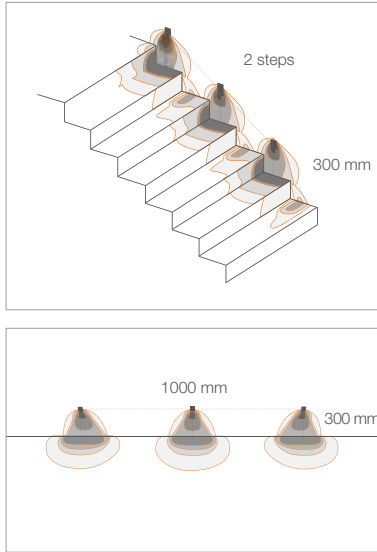

STEP OUTSIDE 5.1

A - Asymmetrical

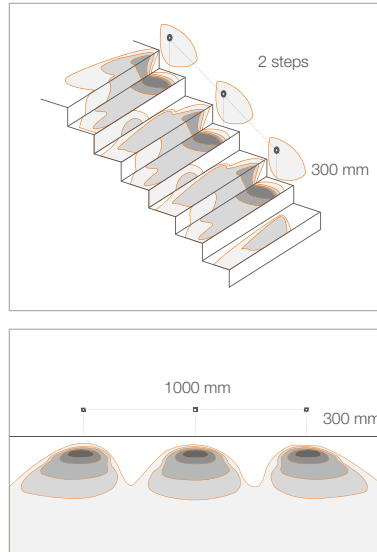

STEP OUTSIDE 5.2

A - Asymmetrical

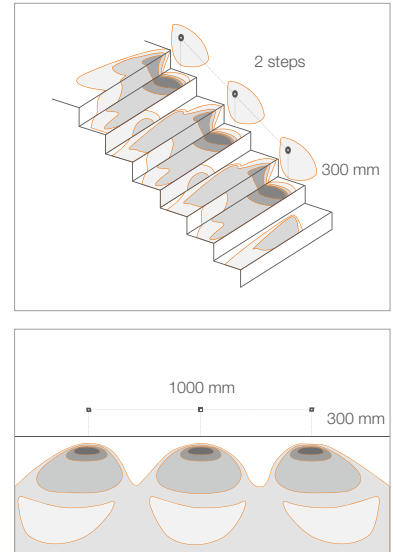

STEP OUTSIDE 7.0

A - Diffuse

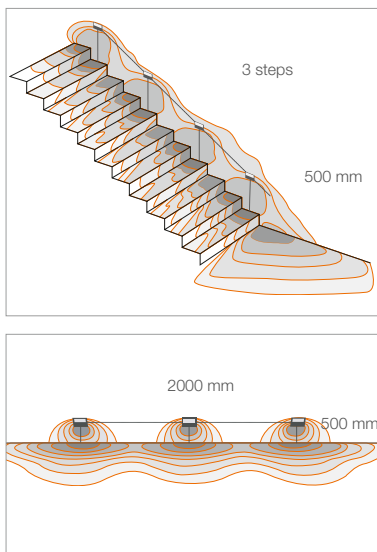

STEP OUTSIDE 8.0

A - Diffuse

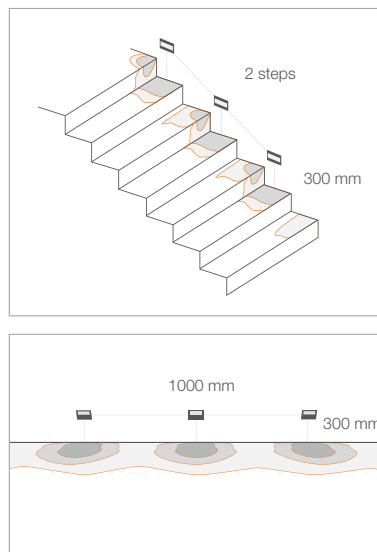

POSITIONING DIAGRAMS

STEP OUTSIDE 6.1

A - Asymmetrical

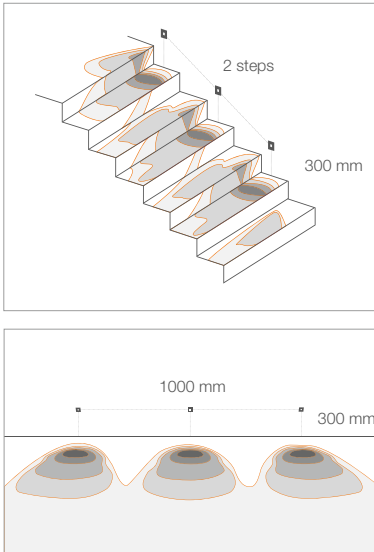

STEP OUTSIDE 6.2

A - Asymmetrical

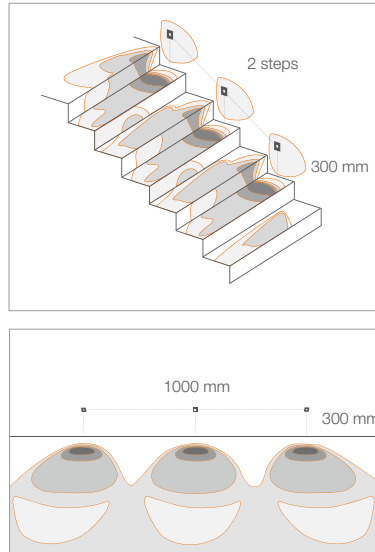

STEP OUTSIDE 6.3

A - Asymmetrical

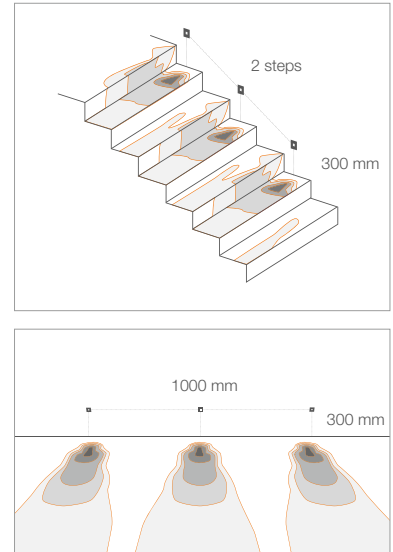



OUTDOOR STEP LIGHTS LIGHTING FOR PATHS AND STEPS

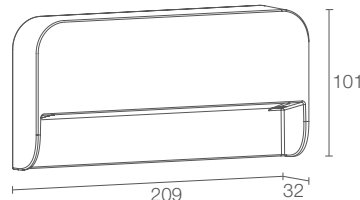
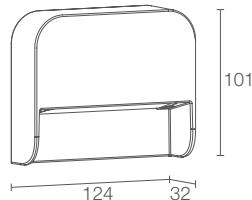

LIRA 1.0



POWER / POWER SUPPLY CODE

6W 230Vac
LR1010 ■ **A E** White
LR1010 ■ **A F** Grey
LR1010 ■ **A H** Anthracite
LR1010 ■ **A T** Cor-ten

LED COLOUR

F - 2700K
5 - 3000K
9 - 4000K

OPTICS

asymmetrical

LUMEN OUTPUT AT SOURCE	756 lm (3000K)
DELIVERED LUMEN OUTPUT	368 lm (3000K, white finish)
NO. AND TYPE OF LED	18 mid-power LEDs 3-step MacAdam, 50000h L80 B10 (Ta 25°C)
MATERIAL	body in die-cast aluminium screen in serigraphed extra-clear microprismatic glass
POWER SUPPLY UNIT	built in
POWER CABLES	includes 1.5 m neoprene cable H05RN-F 3x1.00 Ø7.0 mm
MOUNTING	surface mounted (wall)
ACCESSORIES	see p. 447
NOTES	Casambi-compatible version, controllable with the Casambi app, available on request
PHOTOMETRIC DATA	see p. 847

LIRA 2.0

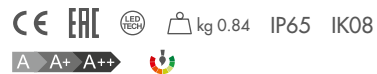

12W 230Vac
LR2010 ■ **A E** White
LR2010 ■ **A F** Grey
LR2010 ■ **A H** Anthracite
LR2010 ■ **A T** Cor-ten

■ **F** - 2700K
5 - 3000K
9 - 4000K

asymmetrical

LUMEN OUTPUT AT SOURCE	1512 lm (3000K)
DELIVERED LUMEN OUTPUT	736 lm (3000K, white finish)
NO. AND TYPE OF LED	36 mid-power LEDs 3-step MacAdam, 50000h L80 B10 (Ta 25°C)
MATERIAL	body in die-cast aluminium screen in serigraphed extra-clear microprismatic glass
POWER SUPPLY UNIT	built in
POWER CABLES	includes 1.5 m neoprene cable H05RN-F 3x1.00 Ø7.0 mm
MOUNTING	surface mounted (wall)
ACCESSORIES	see p. 447
NOTES	Casambi-compatible version, controllable with the Casambi app, available on request
PHOTOMETRIC DATA	see p. 847



**POSITIONING
DIAGRAMS**

LIRA 1.0

A - Asymmetrical

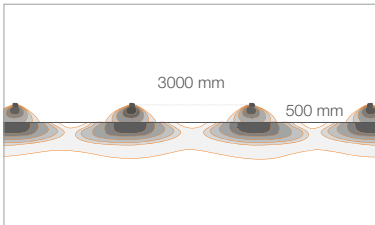
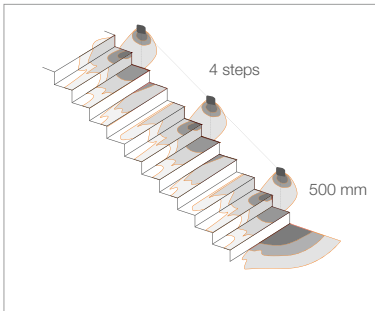

LIRA 2.0

A - Asymmetrical

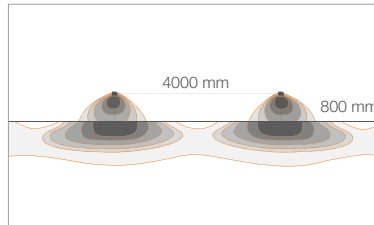
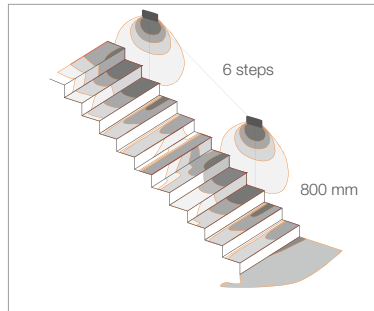

ACCESSORIES AND POSITIONING DIAGRAMS

ACCESSORIES FOR INSTALLATION



WC0301

Optional outer casing

LIRA 1.0

3000K, 6W, anthracite

Project by / Corinne Vezzoni & Associés

Light planning by / 8' 18''

thecamp, Aix-en-Provence, France





OUTDOOR STEP LIGHTS LIGHT POINT FOR GARDENS AND FLOWERBEDS

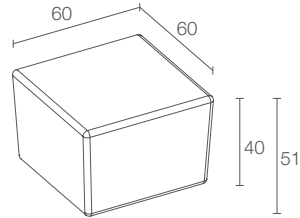
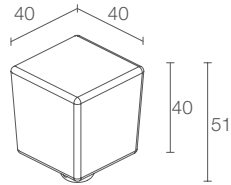
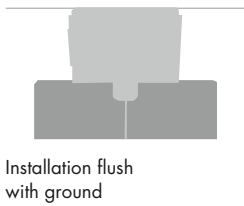
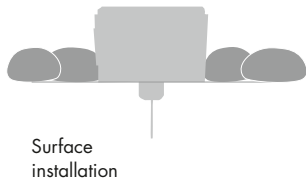

ICE LED 1.0



POWER / POWER SUPPLY CODE

max 1W max 350mA
LE1011 ■ D A V - ■

LED COLOUR

F - 2700K
5 - 3000K
9 - 4000K
0 - 5000K
1 - blue

POWER CABLES

includes 1.5 m neoprene cable
H05RN-F 2x0.35/0.75 Ø6.3 mm
1 - 5 m
2 - 10 m
3 - 15 m
4 - 20 m

OPTICS

diffuse

LUMEN OUTPUT AT SOURCE 110 lm (3000K, 350mA)

DELIVERED LUMEN OUTPUT 89 lm (3000K, 350mA)

NO. AND TYPE OF LED 1 power LED
1/4 ANSI BIN (white LED colour)
50000h L90 B10 (Ta 25°C)

MATERIAL body in anodized aluminium and sandblasted glass

POWER SUPPLY UNIT not included, see p. 904

WIRING series

MOUNTING recessed (wall, ground)
surface mounted (ground)

ACCESSORIES see p. 451

NOTES certified ETL version available on request

PHOTOMETRIC DATA see p. 836

ICE LED 1.1



max 1W max 350mA
LE1111 ■ D A V - ■

F - 2700K
5 - 3000K
9 - 4000K
0 - 5000K
1 - blue

includes 1.5 m neoprene cable
H05RN-F 2x0.35/0.75 Ø6.3 mm
1 - 5 m
2 - 10 m
3 - 15 m
4 - 20 m

diffuse

LUMEN OUTPUT AT SOURCE 110 lm (3000K, 350mA)

DELIVERED LUMEN OUTPUT 89 lm (3000K, 350mA)

1 power LED
1/4 ANSI BIN (white LED colour)
50000h L90 B10 (Ta 25°C)

body in anodized aluminium and sandblasted glass

not included, see p. 904

series

recessed (wall, ground)
surface mounted (ground)

see p. 451

certified ETL version available on request

see p. 836



ACCESSORIES

ACCESSORIES FOR INSTALLATION

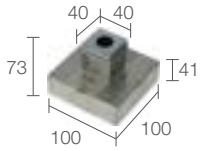

WC0410
Outer casing
(Ice LED 1.0)

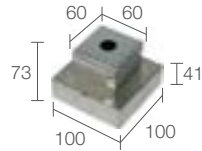

WC0411
Outer casing
(Ice LED 1.1)





BOLLARDS AND URBAN LIGHTING

BOLLARDS

PLIN p. 456 **1**

LINEAR p. 472 **2**









BITTA p. 484 **3**

URBAN LIGHTING

SIRI BLVD p. 488 **4**



BOLLARDS

	MOUNTING	HEIGHT	BEAM	LIGHT COLOUR
PLIN see p. 456 	GROUND		single beam / double beam circular	 2200K 2700K 3000K 4000K
LINEAR see p. 472 	GROUND		1 / 2 / 3 / 4 beams	 2700K 3000K 4000K
BITTA see p. 484 	GROUND		single beam / double beam	 2700K 3000K 4000K 5000K

URBAN LIGHTING

SIRI BLVD see p. 488 	POLE WALL		single beam	 2700K 3000K 4000K
--	--------------	--	-------------	--



BOLLARDS AND URBAN LIGHTING

POWER SUPPLY	CONTROL SYSTEM	IP	APPLIANCE CLASS
MAINS VOLTAGE (built-in power supply unit) 230Vac		IP65	⊕
MAINS VOLTAGE (built-in power supply unit) 230Vac		IP65	⊕
MAINS VOLTAGE (built-in power supply unit) 230Vac		IP65	⊕
MAINS VOLTAGE (built-in power supply unit) 230Vac	VIRTUAL MIDNIGHT	IP66	⊞



^
PLIN 6.1
 3000K, 14W, anthracite

SQUARE HEAD

2700K 3000K 4000K



diffuse



PLIN 1.0 p. 458
 12W 230Vac
 h 300 mm



PLIN 1.1 p. 459
 12W 230Vac
 h 600 mm



PLIN 1.2 p. 459
 12W 230Vac
 h 800 mm

2700K 3000K 4000K



asymmetrical
diffuse



PLIN 2.0 p. 460
 12W 230Vac
 h 260 mm



PLIN 2.1 p. 461
 12W 230Vac
 h 560 mm



PLIN 2.2 p. 461
 12W 230Vac
 h 760 mm

2700K 3000K 4000K

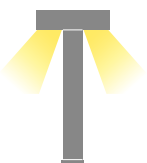

asymmetrical
diffuse



PLIN 3.0 p. 462
 24W 230Vac
 h 260 mm



PLIN 3.1 p. 463
 24W 230Vac
 h 560 mm



PLIN 3.2 p. 463
 24W 230Vac
 h 760 mm



OUTDOOR BOLLARDS

ROUND HEAD

2700K 3000K 4000K



diffuse



PLIN 4.0 p. 464
8W 230Vac
h 320 mm



PLIN 4.1 p. 465
8W 230Vac
h 620 mm



PLIN 4.2 p. 465
8W 230Vac
h 820 mm

2700K 3000K 4000K



asymmetrical
diffuse



PLIN 5.0 p. 466
8W 230Vac
h 285 mm



PLIN 5.1 p. 467
8W 230Vac
h 585 mm



PLIN 5.2 p. 467
8W 230Vac
h 785 mm

2200K 2700K 3000K 4000K



asymmetrical
circular



PLIN 6.0 p. 468
14W 230Vac
h 285 mm



PLIN 6.1 p. 469
14W 230Vac
h 585 mm



PLIN 6.2 p. 469
14W 230Vac
h 785 mm



^
PLIN 1.1
 3000K, anthracite
 Light planning by/ KA2 Light Architecture
 Caméo Moscow Villas, Moscow, Russia

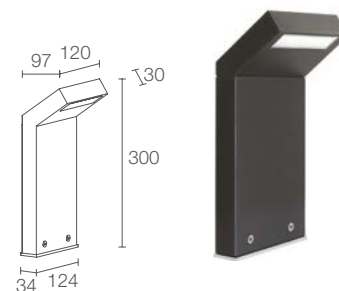

PLIN 1.0



CE CB EAC LED TECH kg 1.30 IP65 IK08
 A A+ A++

POWER / POWER SUPPLY CODE	12W 230Vac h 300 mm PN1010 ■ A E White PN1010 ■ A F Grey PN1010 ■ A H Anthracite PN1010 ■ A T Cor-ten
LED COLOUR	F - 2700K 5 - 3000K 9 - 4000K
OPTICS	diffuse
LUMEN OUTPUT AT SOURCE	1242 lm (3000K)
DELIVERED LUMEN OUTPUT	558 lm (3000K)
NO. AND TYPE OF LED	18 mid-power LEDs 3-step MacAdam, 50000h L85 B10 (Ta 25°C)
MATERIAL	head in die-cast aluminium, column in aluminium screen in serigraphed, tempered, extra-clear microprismatic glass
POWER SUPPLY UNIT	built in
MOUNTING	surface mounted (ground)
NOTES	non-standard heights available on request Casambi-compatible version, controllable with the Casambi app, available on request
PHOTOMETRIC DATA	see p. 863

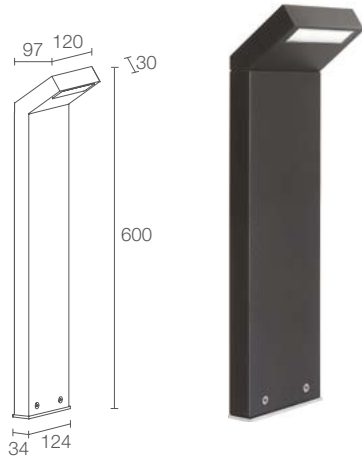

PLIN 1.1



CE CB ENEC LED TEST kg 2.20 IP65 IK08
 A A+ A++

12W 230Vac h 600 mm
PN1110 **A E** White
PN1110 **A F** Grey
PN1110 **A H** Anthracite
PN1110 **A T** Cor-ten

F - 2700K
5 - 3000K
9 - 4000K

diffuse

1242 lm (3000K)

558 lm (3000K)

18 mid-power LEDs
 3-step MacAdam, 50000h L85 B10 (Ta 25°C)

head in die-cast aluminium, column in aluminium
 screen in serigraphed, tempered, extra-clear
 microprismatic glass

built in

surface mounted (ground)

non-standard heights available
 on request
 Casambi-compatible version, controllable with
 the Casambi app, available on request

see p. 863

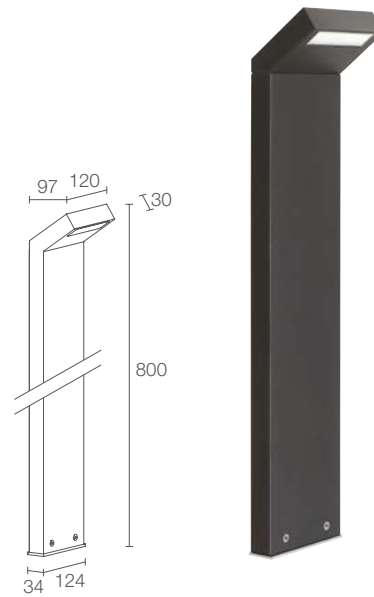

PLIN 1.2



CE CB ENEC LED TEST kg 2.50 IP65 IK08
 A A+ A++

12W 230Vac h 800 mm
PN1210 **A E** White
PN1210 **A F** Grey
PN1210 **A H** Anthracite
PN1210 **A T** Cor-ten

F - 2700K
5 - 3000K
9 - 4000K

diffuse

1242 lm (3000K)

558 lm (3000K)

18 mid-power LEDs
 3-step MacAdam, 50000h L85 B10 (Ta 25°C)

head in die-cast aluminium, column in aluminium
 screen in serigraphed, tempered, extra-clear
 microprismatic glass

built in

surface mounted (ground)

non-standard heights available
 on request
 Casambi-compatible version, controllable with
 the Casambi app, available on request

see p. 863





^
PLIN 2.2
 3000K, 12W, anthracite
ICE LED 1.0
 2700K, 1W

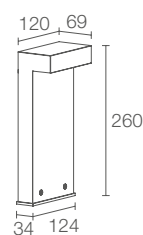

PLIN 2.0



CE CB EAC LED TECH kg 1.40 IP65 IK08
 A A+ A++

POWER / POWER SUPPLY CODE	12W 230Vac h 260 mm PN2010 ■ A E White PN2010 ■ A F Grey PN2010 ■ A H Anthracite PN2010 ■ A T Cor-ten
LED COLOUR	F - 2700K 5 - 3000K 9 - 4000K
OPTICS	asymmetrical diffuse
LUMEN OUTPUT AT SOURCE	1242 lm (3000K)
DELIVERED LUMEN OUTPUT	492 lm (3000K)
NO. AND TYPE OF LED	18 mid-power LEDs 3-step MacAdam, 50000h L85 B10 (Ta 25°C)
MATERIAL	head and column in aluminium screen in serigraphed, tempered transparent extra-clear glass
POWER SUPPLY UNIT	built in
MOUNTING	surface mounted (ground)
NOTES	non-standard heights available on request Casambi-compatible version, controllable with the Casambi app, available on request
PHOTOMETRIC DATA	see p. 863

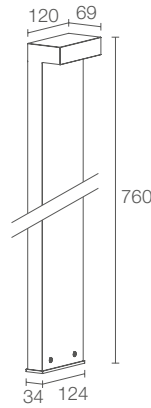
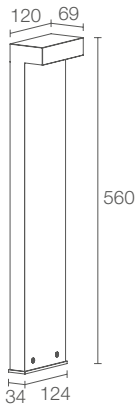

PLIN 2.1



CE CB ENEC LED TEST kg 1.92 IP65 IK08
 A A+ A++

12W 230Vac h 560 mm
PN2110 A E White
PN2110 A F Grey
PN2110 A H Anthracite
PN2110 A T Cor-ten

F - 2700K
 5 - 3000K
 9 - 4000K

asymmetrical diffuse

1242 lm (3000K)

492 lm (3000K)

18 mid-power LEDs
 3-step MacAdam, 50000h L85 B10 (Ta 25°C)

head and column in aluminium
 screen in serigraphed, tempered transparent
 extra-clear glass

built in

surface mounted (ground)

non-standard heights available
 on request
 Casambi-compatible version, controllable with
 the Casambi app, available on request

see p. 863

PLIN 2.2



CE CB ENEC LED TEST kg 1.95 IP65 IK08
 A A+ A++

12W 230Vac h 760 mm
PN2210 A E White
PN2210 A F Grey
PN2210 A H Anthracite
PN2210 A T Cor-ten

F - 2700K
 5 - 3000K
 9 - 4000K

asymmetrical diffuse

1242 lm (3000K)

492 lm (3000K)

18 mid-power LEDs
 3-step MacAdam, 50000h L85 B10 (Ta 25°C)

head and column in aluminium
 screen in serigraphed, tempered transparent
 extra-clear glass

built in

surface mounted (ground)

non-standard heights available
 on request
 Casambi-compatible version, controllable with
 the Casambi app, available on request

see p. 863





^
PLIN 3.1
 4000K, 24W, anthracite

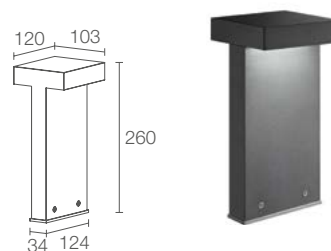

PLIN 3.0



CE CB EAC LED TECH kg 1.80 IP65 IK08
 A A+ A++

POWER / POWER SUPPLY CODE	24W 230Vac h 260 mm PN3010 ■ A E White PN3010 ■ A F Grey PN3010 ■ A H Anthracite PN3010 ■ A T Cor-ten
LED COLOUR	F - 2700K 5 - 3000K 9 - 4000K
OPTICS	asymmetrical diffuse
LUMEN OUTPUT AT SOURCE	2484 lm (3000K)
DELIVERED LUMEN OUTPUT	984 lm (3000K)
NO. AND TYPE OF LED	36 mid-power LEDs 3-step MacAdam, 50000h L85 B10 (Ta 25°C)
MATERIAL	head and column in aluminium screen in serigraphed, tempered transparent extra-clear glass
POWER SUPPLY UNIT	built in
MOUNTING	surface mounted (ground)
NOTES	non-standard heights available on request Casambi-compatible version, controllable with the Casambi app, available on request
PHOTOMETRIC DATA	see p. 863

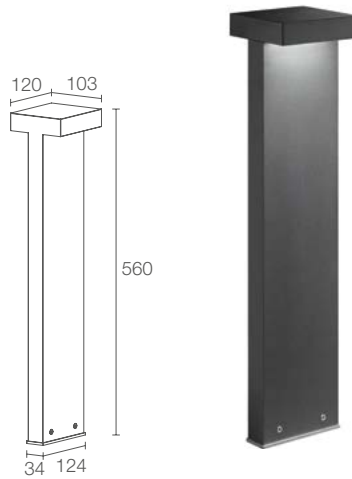

PLIN 3.1

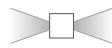

CE CB ENEC LED TECH kg 2.20 IP65 IK08
A A+ A++

24W 230Vac h 560 mm
PN3110 **A E** White
PN3110 **A F** Grey
PN3110 **A H** Anthracite
PN3110 **A T** Cor-ten

F - 2700K
5 - 3000K
9 - 4000K

asymmetrical diffuse

2484 lm (3000K)

984 lm (3000K)

36 mid-power LEDs
 3-step MacAdam, 50000h L85 B10 (Ta 25°C)

head and column in aluminium
 screen in serigraphed, tempered transparent
 extra-clear glass

built in

surface mounted (ground)

non-standard heights available
 on request
 Casambi-compatible version, controllable with
 the Casambi app, available on request

see p. 863

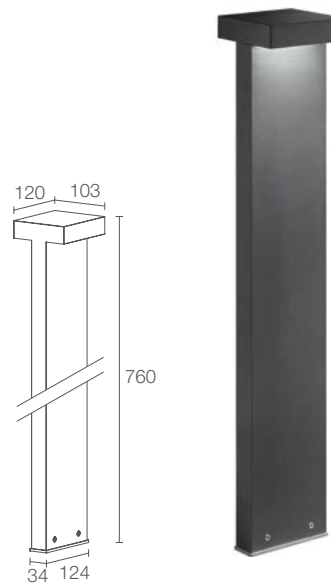

PLIN 3.2

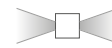

CE CB ENEC LED TECH kg 2.35 IP65 IK08
A A+ A++

24W 230Vac h 760 mm
PN3210 **A E** White
PN3210 **A F** Grey
PN3210 **A H** Anthracite
PN3210 **A T** Cor-ten

F - 2700K
5 - 3000K
9 - 4000K

asymmetrical diffuse

2484 lm (3000K)

984 lm (3000K)

36 mid-power LEDs
 3-step MacAdam, 50000h L85 B10 (Ta 25°C)

head and column in aluminium
 screen in serigraphed, tempered transparent
 extra-clear glass

built in

surface mounted (ground)

non-standard heights available
 on request
 Casambi-compatible version, controllable with
 the Casambi app, available on request

see p. 863





^
PLIN 4.0
 4000K, 8W, anthracite

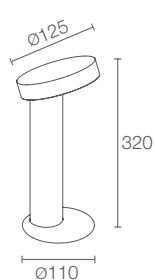

PLIN 4.0

kg 1.80 IP65 IK07

POWER / POWER SUPPLY CODE	8W 230Vac h 320 mm
	PN40100 D E White
	PN40100 D F Grey
	PN40100 D H Anthracite
	PN40100 D T Cor-ten

LED COLOUR	F - 2700K 5 - 3000K 9 - 4000K
-------------------	--

OPTICS	diffuse
---------------	---------

LUMEN OUTPUT AT SOURCE	488 lm (3000K)
DELIVERED LUMEN OUTPUT	423 lm (3000K)
NO. AND TYPE OF LED	1 power LED 3-step MacAdam, 50000h L90 B10 (Ta 25°C)
MATERIAL	head in aluminium, column in stainless steel screen in serigraphed and transparent, tempered extra-clear glass
POWER SUPPLY UNIT	built in
MOUNTING	surface mounted (ground)
ACCESSORIES	see p. 471
NOTES	non-standard heights available on request Casambi-compatible version, controllable with the Casambi app, available on request
PHOTOMETRIC DATA	see p. 864

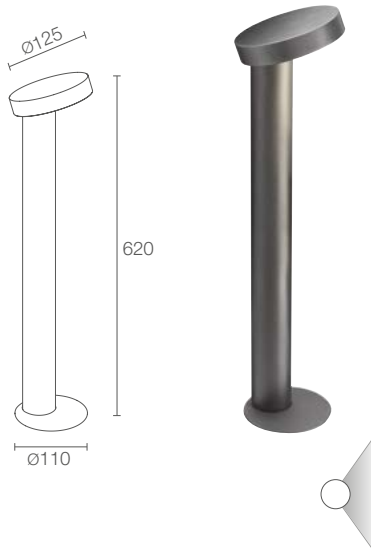

PLIN 4.1

CE CB ENE LED TECH kg 2.65 IP65 IK07
 A A+ A++

8W 230Vac h 620 mm
PN41100 D E White
PN41100 D F Grey
PN41100 D H Anthracite
PN41100 D T Cor-ten

F - 2700K
 5 - 3000K
 9 - 4000K

diffuse

488 lm (3000K)

423 lm (3000K)

1 power LED
 3-step MacAdam, 50000h L90 B10 (Ta 25°C)

head in aluminium, column in stainless steel
 screen in serigraphed and transparent,
 tempered extra-clear glass

built in

surface mounted (ground)

see p. 471

non-standard heights available
 on request
 Casambi-compatible version, controllable with
 the Casambi app, available on request

see p. 864

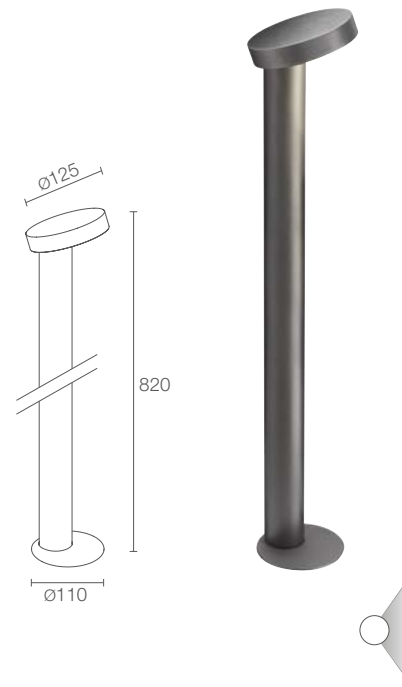

PLIN 4.2

CE CB ENE LED TECH kg 3.10 IP65 IK07
 A A+ A++

8W 230Vac h 820 mm
PN42100 D E White
PN42100 D F Grey
PN42100 D H Anthracite
PN42100 D T Cor-ten

F - 2700K
 5 - 3000K
 9 - 4000K

diffuse

488 lm (3000K)

423 lm (3000K)

1 power LED
 3-step MacAdam, 50000h L90 B10 (Ta 25°C)

head in aluminium, column in stainless steel
 screen in serigraphed and transparent,
 tempered extra-clear glass

built in

surface mounted (ground)

see p. 471

non-standard heights available
 on request
 Casambi-compatible version, controllable with
 the Casambi app, available on request

see p. 864





^
PLIN 5.1
 4000K, 8W, anthracite

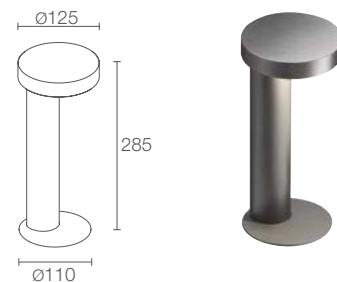

PLIN 5.0



CE CB EAC LED TECH kg 1.80 IP65 IK07
 A A+ A++

POWER / POWER SUPPLY CODE	8W 230Vac h 285 mm
	PN50100 ■ A E White
	PN50100 ■ A F Grey
	PN50100 ■ A H Anthracite
	PN50100 ■ A T Cor-ten

LED COLOUR	F - 2700K
	5 - 3000K
	9 - 4000K

OPTICS	asymmetrical
---------------	--------------

LUMEN OUTPUT AT SOURCE	488 lm (3000K)
DELIVERED LUMEN OUTPUT	173 lm (3000K)
NO. AND TYPE OF LED	1 power LED 3-step MacAdam, 50000h L90 B10 (Ta 25°C)
MATERIAL	head in aluminium, column in stainless steel screen in serigraphed and transparent, tempered extra-clear glass
POWER SUPPLY UNIT	built in
MOUNTING	surface mounted (ground)
ACCESSORIES	see p. 471
NOTES	non-standard heights available on request Casambi-compatible version, controllable with the Casambi app, available on request
PHOTOMETRIC DATA	see p. 864



PLIN 5.1



CE CB ENEC LED TECH kg 2.50 IP65 IK07
 A A+ A++

8W 230Vac h 585 mm
PN51100 **A E** White
PN51100 **A F** Grey
PN51100 **A H** Anthracite
PN51100 **A T** Cor-ten

F - 2700K
5 - 3000K
9 - 4000K

asymmetrical

488 lm (3000K)

173 lm (3000K)

1 power LED
 3-step MacAdam, 50000h L90 B10 (Ta 25°C)

head in aluminium, column in stainless steel
 screen in serigraphed and transparent,
 tempered extra-clear glass

built in

surface mounted (ground)

see p. 471

non-standard heights available
 on request
 Casambi-compatible version, controllable with
 the Casambi app, available on request

see p. 864

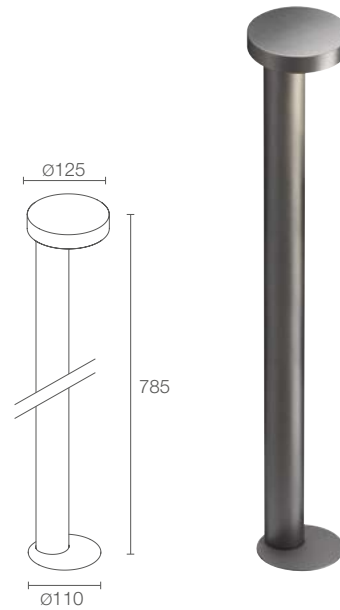

PLIN 5.2



CE CB ENEC LED TECH kg 3.10 IP65 IK07
 A A+ A++

8W 230Vac h 785 mm
PN52100 **A E** White
PN52100 **A F** Grey
PN52100 **A H** Anthracite
PN52100 **A T** Cor-ten

F - 2700K
5 - 3000K
9 - 4000K

asymmetrical

488 lm (3000K)

173 lm (3000K)

1 power LED
 3-step MacAdam, 50000h L90 B10 (Ta 25°C)

head in aluminium, column in stainless steel
 screen in serigraphed and transparent,
 tempered extra-clear glass

built in

surface mounted (ground)

see p. 471

non-standard heights available
 on request
 Casambi-compatible version, controllable with
 the Casambi app, available on request

see p. 864



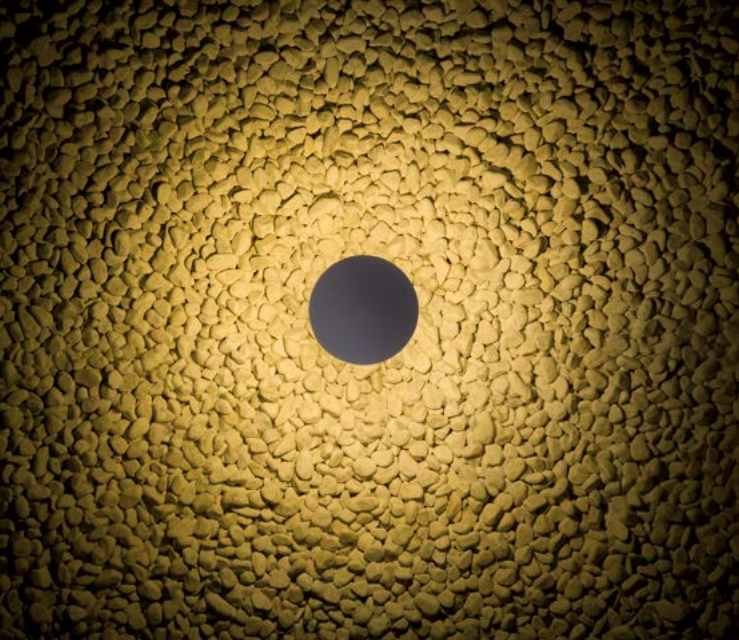

^
PLIN 6.1
 2200K, 14W, grey



PLIN 6.0

CE ENEC LED TECH kg 2.00 IP65 IK07
 A A+ A++ PID

POWER / POWER SUPPLY CODE 14W 230Vac h 285 mm
PN60100000 **OA E** White
PN60100000 **OA F** Grey
PN60100000 **OA H** Anthracite
PN60100000 **OA T** Cor-ten

LED COLOUR
N - 2200K
F - 2700K
5 - 3000K
9 - 4000K

OPTICS asymmetrical circular

LUMEN OUTPUT AT SOURCE	1560 lm (3000K)
DELIVERED LUMEN OUTPUT	1160 lm (3000K)
NO. AND TYPE OF LED	8 power LED 2-step MacAdam, 60000h L90 B10 (Ta 25°C)
MATERIAL	head in aluminium, column in stainless steel screen in serigraphed and transparent, tempered extra-clear glass
POWER SUPPLY UNIT	built in
MOUNTING	surface mounted (ground)
ACCESSORIES	see p. 471
NOTES	non-standard heights available on request Casambi-compatible version, controllable with the Casambi app, available on request
PHOTOMETRIC DATA	see p. 864

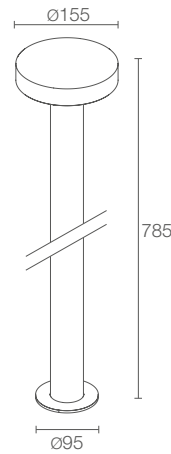
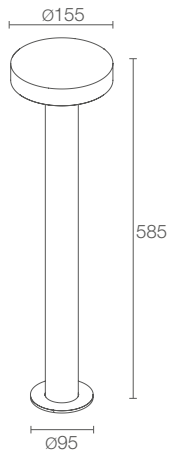

PLIN 6.1

CE EAC LED TECH kg 2.50 IP65 IK07

A A+ A++ PID

14W 230Vac h 585 mm
PN6110000 OA E White
PN6110000 OA F Grey
PN6110000 OA H Anthracite
PN6110000 OA T Cor-ten

■ N - 2200K
 F - 2700K
 5 - 3000K
 9 - 4000K

asymmetrical circular

1560 lm (3000K)

1160 lm (3000K)

8 power LED
 2 step MacAdam, 60000h L90 B10 (T_a 25°C)

head in aluminium, column in stainless steel
 screen in serigraphed and transparent,
 tempered extra-clear glass

built in

surface mounted (ground)

see p. 471

non-standard heights available
 on request
 Casambi-compatible version, controllable with
 the Casambi app, available on request

see p. 864

PLIN 6.2

CE EAC LED TECH kg 3.00 IP65 IK07

A A+ A++ PID

14W 230Vac h 785 mm
PN6210000 OA E White
PN6210000 OA F Grey
PN6210000 OA H Anthracite
PN6210000 OA T Cor-ten

■ N - 2200K
 F - 2700K
 5 - 3000K
 9 - 4000K

asymmetrical circular

1560 lm (3000K)

1160 lm (3000K)

8 power LED
 2 step MacAdam, 60000h L90 B10 (T_a 25°C)

head in aluminium, column in stainless steel
 screen in serigraphed and transparent,
 tempered extra-clear glass

built in

surface mounted (ground)

see p. 471

non-standard heights available
 on request
 Casambi-compatible version, controllable with
 the Casambi app, available on request

see p. 864



**POSITIONING
DIAGRAMS**

PLIN 1.0

A - Diffuse

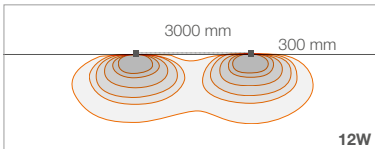

PLIN 1.1

A - Diffuse

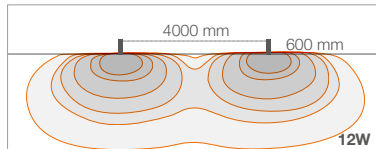

PLIN 1.2

A - Diffuse

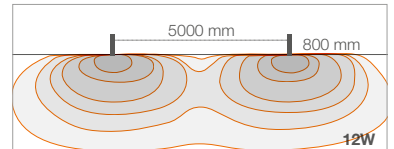

PLIN 2.0

A - Asymmetrical diffuse

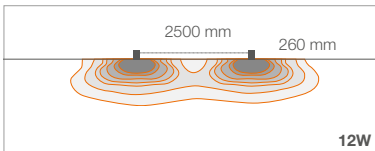

PLIN 2.1

A - Asymmetrical diffuse

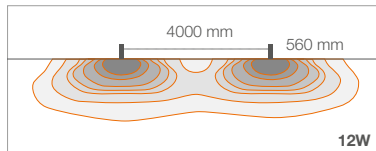

PLIN 2.2

A - Asymmetrical diffuse

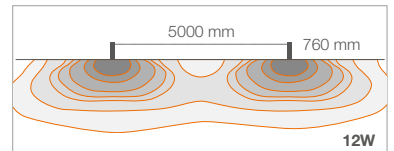

PLIN 4.0

D - Diffuse

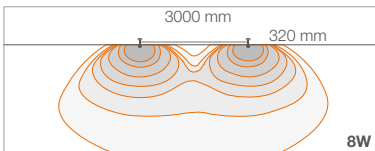

PLIN 4.1

D - Diffuse

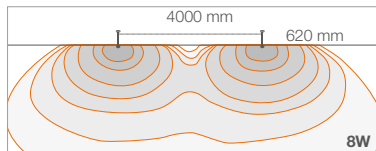

PLIN 4.2

D - Diffuse

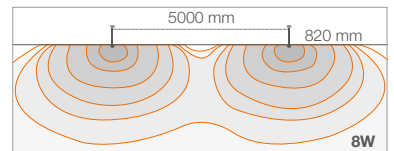

PLIN 5.0

A - Asymmetrical

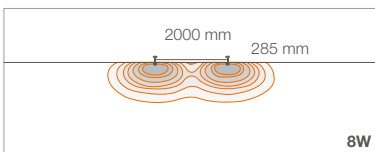

PLIN 5.1

A - Asymmetrical

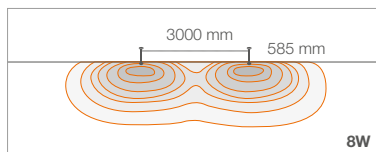

PLIN 5.2

A - Asymmetrical

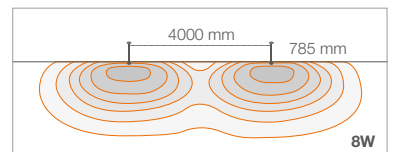

PLIN 6.0

A - Asymmetrical circular

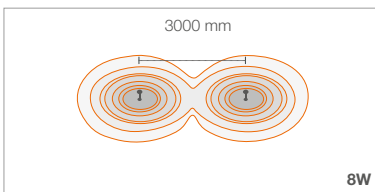

PLIN 6.1

A - Asymmetrical circular

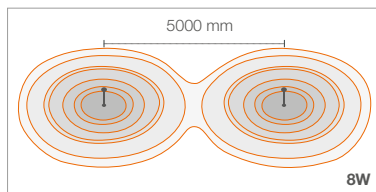

PLIN 6.2

A - Asymmetrical circular

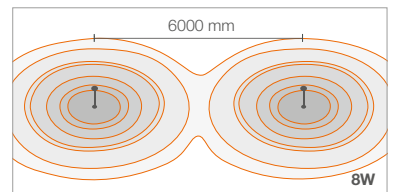



ACCESSORIES AND POSITIONING DIAGRAMMS

ACCESSORIES FOR INSTALLATION



WPA00

Spike for installation in the ground
(Plin 4 / 5 / 6)

PLIN 4.0
3000K, 8W, anthracite

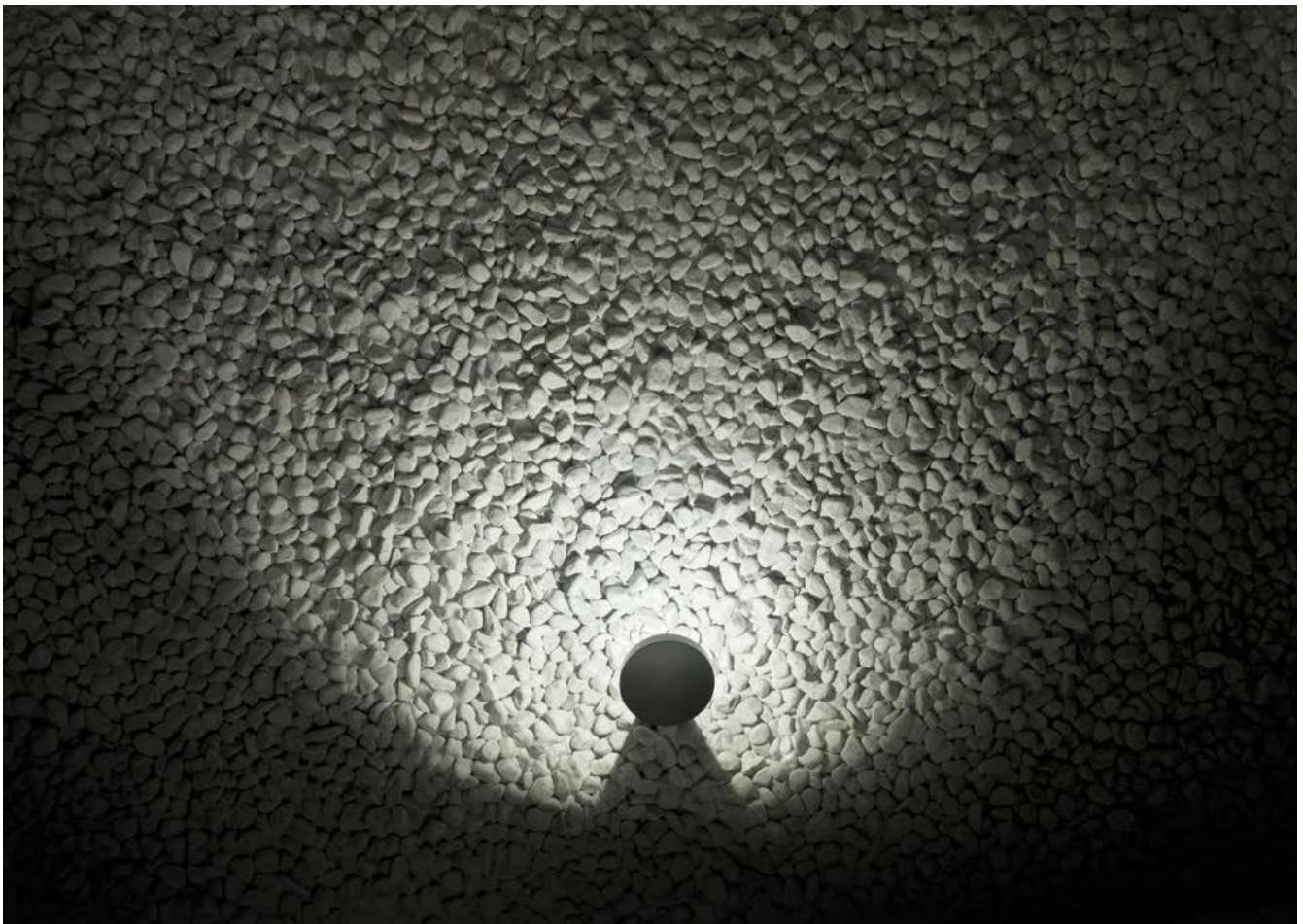



472

L&L Luce&Light



OUTDOOR BOLLARDS



asymmetrical



2700K 3000K 4000K

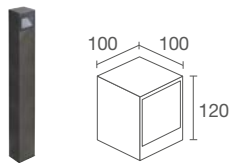

HEIGHT 250/600/800 mm

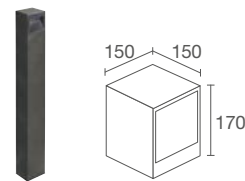

HEIGHT 600/800 mm



LINEAR 2.1 p. 474
4W/8.5W 230Vac

LINEAR 4.1 p. 478
8W/16W 230Vac



LINEAR 2.2 p. 474
7W/15W 230Vac

LINEAR 4.2 p. 479
14W/32W 230Vac

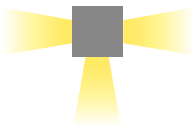

LINEAR 2.3 p. 475
10W 230Vac

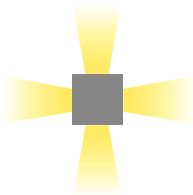

LINEAR 2.4 p. 475
13W 230Vac

LINEAR 4.4 p. 479
28W 230Vac

< **LINEAR 2.1/2.4/4.2**
3000K, 4W - 13W - 14W, anthracite
height 250 mm - 600 mm - 800 mm

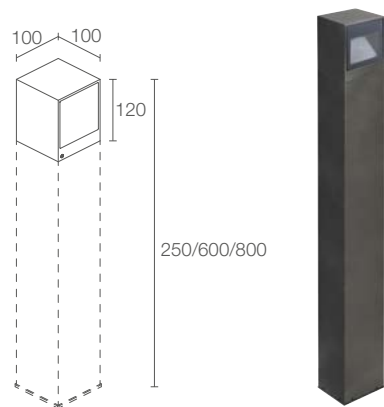
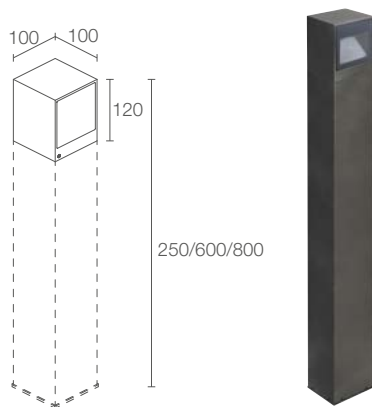

LINEAR 2.1



POWER / POWER SUPPLY CODE

4W 230Vac
CL2110 ■ **A F** Grey
CL2110 ■ **A H** Anthracite
CL2110 ■ **A T** Cor-ten

8.5W 230Vac
CL2111 ■ **A F** Grey
CL2111 ■ **A H** Anthracite
CL2111 ■ **A T** Cor-ten

LED COLOUR

F - 2700K
5 - 3000K
9 - 4000K

OPTICS

asymmetrical

LUMEN OUTPUT AT SOURCE 184 lm (3000K, 4W)
 657 lm (3000K, 8.5W)

DELIVERED LUMEN OUTPUT 100 lm (3000K, 4W)
 284 lm (3000K, 8.5W)

NO. AND TYPE OF LED 1 power LED, 1/4 ANSI BIN (4W version)
 1 high-intensity power LED
 3-step MacAdam (8.5W version)
 50000h L90 B10 (Ta 25°C)

MATERIAL head in aluminium, column in anticorodal aluminium
 screen in serigraphed and transparent,
 tempered extra-clear glass

POWER SUPPLY UNIT built in

POWER CABLES connection box with 1 m cable
 H05RN-F 2x0.75 Ø6.3 mm

MOUNTING surface mounted (ground)

ACCESSORIES see p. 481

NOTES non-standard heights available
 on request
 Casambi-compatible version, controllable with
 the Casambi app, available on request

PHOTOMETRIC DATA see p. 845

LINEAR 2.2



7W 230Vac
CL2210 ■ **A F** Grey
CL2210 ■ **A H** Anthracite
CL2210 ■ **A T** Cor-ten

15W 230Vac
CL2211 ■ **A F** Grey
CL2211 ■ **A H** Anthracite
CL2211 ■ **A T** Cor-ten

F - 2700K
5 - 3000K
9 - 4000K

asymmetrical

LUMEN OUTPUT AT SOURCE 368 lm (3000K, 7W)
 1314 lm (3000K, 15W)

DELIVERED LUMEN OUTPUT 200 lm (3000K, 7W)
 568 lm (3000K, 15W)

NO. AND TYPE OF LED 2 power LEDs, 1/4 ANSI BIN (7W version)
 2 high-intensity power LEDs
 3-step MacAdam (15W version)
 50000h L90 B10 (Ta 25°C)

MATERIAL head in aluminium, column in anticorodal aluminium
 screen in serigraphed and transparent,
 tempered extra-clear glass

POWER SUPPLY UNIT built in

POWER CABLES connection box with 1 m cable
 H05RN-F 2x0.75 Ø6.3 mm

MOUNTING surface mounted (ground)

ACCESSORIES see p. 481

NOTES non-standard heights available
 on request
 Casambi-compatible version, controllable with
 the Casambi app, available on request

PHOTOMETRIC DATA see p. 845

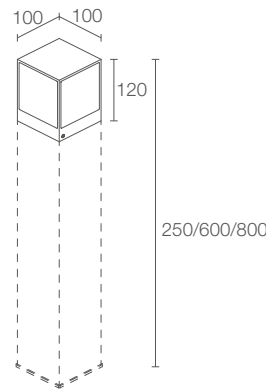
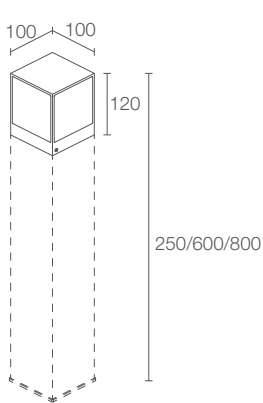

LINEAR 2.3

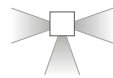

kg 1.60
 kg 2.00 h 250 mm
 kg 2.70 h 600 mm
 kg 3.10 h 800 mm

IP65 IK07

10W 230Vac

CL2310 **A F** Grey
CL2310 **A H** Anthracite
CL2310 **A T** Cor-ten

F - 2700K
5 - 3000K
9 - 4000K

asymmetrical

552 lm (3000K)

300 lm (3000K)

3 power LEDs
1/4 ANSI BIN, 50000h L90 B10 (Ta 25°C)

head in aluminium, column in anticorodal aluminium
screen in serigraphed and transparent,
tempered extra-clear glass

built in

connection box with 1 m cable
H05RN-F 2x0.75 Ø6.3 mm

surface mounted (ground)

see p. 481

non-standard heights available
on request
Casambi-compatible version, controllable with
the Casambi app, available on request

see p. 845

LINEAR 2.4

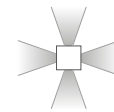

kg 1.60
 kg 2.00 h 250 mm
 kg 2.70 h 600 mm
 kg 3.10 h 800 mm

IP65 IK07

13W 230Vac

CL2410 **A F** Grey
CL2410 **A H** Anthracite
CL2410 **A T** Cor-ten

F - 2700K
5 - 3000K
9 - 4000K

asymmetrical

736 lm (3000K)

400 lm (3000K)

4 power LEDs
1/4 ANSI BIN, 50000h L90 B10 (Ta 25°C)

head in aluminium, column in anticorodal aluminium
screen in serigraphed and transparent,
tempered extra-clear glass

built in

connection box with 1 m cable
H05RN-F 2x0.75 Ø6.3 mm

surface mounted (ground)

see p. 481

non-standard heights available
on request
Casambi-compatible version, controllable with
the Casambi app, available on request

see p. 845







page 476

LINEAR 2.1

3000K, 8.5W, 250/600 mm

BRIGHT 5.F

3000K, 19W, 67°x11°

BRIGHT 1.6

3000K, 2W, 10°

Project by / arch. Ignazio Lo Manto
Light planning by / Gianni Celleno (Elettroged)
Photo by / Moreno Maggi
Campus John Felice, Loyola University
Rome, Italy

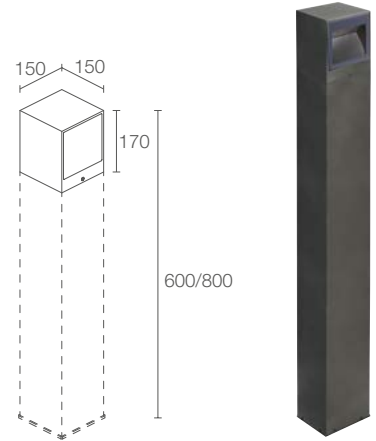

v

LINEAR 2.1

4000K, 4W, anthracite



LINEAR 4.1



CE ENEC LED TOP kg 3.50 h 600 mm
kg 5.30 h 800 mm
kg 6.10 h 800 mm IP65 IK06
A A+ A++ PID

POWER / POWER SUPPLY CODE

8W 230Vac
CL4110 A F Grey
CL4110 A H Anthracite
CL4110 A T Cor-ten

16W 230Vac
CL4111 A F Grey
CL4111 A H Anthracite
CL4111 A T Cor-ten

LED COLOUR

F - 2700K
5 - 3000K
9 - 4000K

OPTICS

asymmetrical

LUMEN OUTPUT AT SOURCE

436 lm (3000K, 8W)
1465 lm (3000K, 16W)

DELIVERED LUMEN OUTPUT

243 lm (3000K, 8W)
609 lm (3000K, 16W)

NO. AND TYPE OF LED

3 power LEDs, 1/4 ANSI BIN (8W version)
3 high-intensity power LEDs
3-step MacAdam (16W version)
50000h L90 B10 (Ta 25°C)

MATERIAL

head in aluminium, column in anticorodal aluminium
screen in serigraphed and transparent,
tempered extra-clear glass

POWER SUPPLY UNIT

built in

POWER CABLES

connection box with 1 m cable
H05RN-F 2x0.75 Ø6.3 mm

MOUNTING

surface mounted (ground)

ACCESSORIES

see p. 481

NOTES

non-standard heights available
on request
Casambi-compatible version, controllable with
the Casambi app, available on request

PHOTOMETRIC DATA

see p. 846

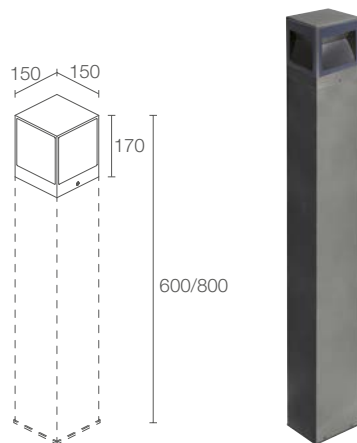
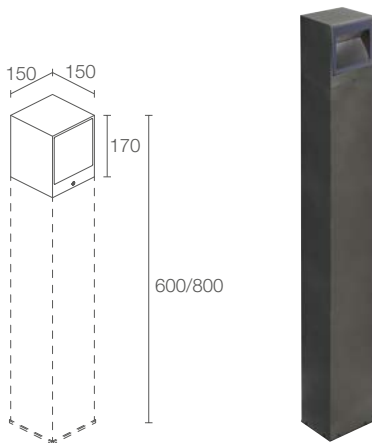

LINEAR 4.2

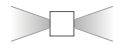

CE ENEC LED TECH kg 3.50 h 600 mm IP65 IK06
kg 5.30 h 800 mm
kg 6.10 h 800 mm
A A+ A++

14W 230Vac
CL4210 ■ **A F** Grey
CL4210 ■ **A H** Anthracite
CL4210 ■ **A T** Cor-ten

32W 230Vac
CL4211 ■ **A F** Grey
CL4211 ■ **A H** Anthracite
CL4211 ■ **A T** Cor-ten

■ **F** - 2700K
5 - 3000K
9 - 4000K

asymmetrical

872 lm (3000K, 14W)
 2930 lm (3000K, 32W)

486 lm (3000K, 14W)
 1218 lm (3000K, 32W)

6 power LEDs, 1/4 ANSI BIN (14W version)
 6 high-intensity power LEDs
 3-step MacAdam (32W version)
 50000h L90 B10 (Ta 25°C)

head in aluminium, column in anticorodal aluminium
 screen in serigraphed and transparent,
 tempered extra-clear glass

built in

connection box with 1 m cable
 H05RN-F 2x0.75 Ø6.3 mm

surface mounted (ground)

see p. 481

non-standard heights available
 on request
 Casambi-compatible version, controllable with
 the Casambi app, available on request

see p. 846

LINEAR 4.4

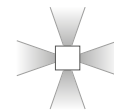

CE CB ENEC LED TECH kg 3.50 h 600 mm IP65 IK06
kg 5.30 h 800 mm
kg 6.10 h 800 mm
A A+ A++

28W 230Vac
CL4410 ■ **A F** Grey
CL4410 ■ **A H** Anthracite
CL4410 ■ **A T** Cor-ten

■ **F** - 2700K
5 - 3000K
9 - 4000K

asymmetrical

1744 lm (3000K)

972 lm (3000K)

12 power LEDs
 1/4 ANSI BIN, 50000h L90 B10 (Ta 25°C)

head in aluminium, column in anticorodal aluminium
 screen in serigraphed and transparent,
 tempered extra-clear glass

built in

connection box with 1 m cable
 H05RN-F 2x0.75 Ø6.3 mm

surface mounted (ground)

see p. 481

non-standard heights available
 on request
 Casambi-compatible version, controllable with
 the Casambi app, available on request

see p. 846







ACCESSORIES

ACCESSORIES FOR INSTALLATION

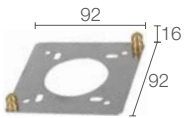

WT000000

Plate for ground installation

(Linear 2.1 / 2.2 / 2.3 / 2.4)

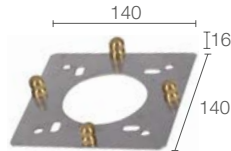

WT000001

Plate for ground installation

(Linear 4.1 / 4.2 / 4.4)

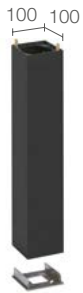

h 250 mm including head

WT20250F - Grey
WT20250H - Anthracite
WT20250T - Cor-ten

h 600 mm including head

WT20600F - Grey
WT20600H - Anthracite
WT20600T - Cor-ten

h 800 mm including head

WT20800F - Grey
WT20800H - Anthracite
WT20800T - Cor-ten

Column

(Linear 2.1 / 2.2 / 2.3 / 2.4)



h 600 mm including head

WT40600F - Grey
WT40600H - Anthracite
WT40600T - Cor-ten

h 800 mm including head

WT40800F - Grey
WT40800H - Anthracite
WT40800T - Cor-ten

Column

(Linear 4.1 / 4.2 / 4.4)

RAL finish available on request

**POSITIONING
DIAGRAMS**

LINEAR 2.1

A - Asymmetrical

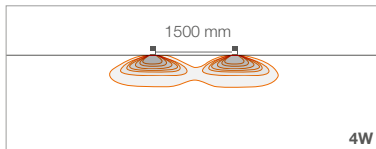

A - Asymmetrical

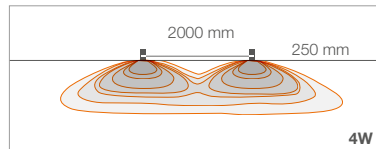

A - Asymmetrical

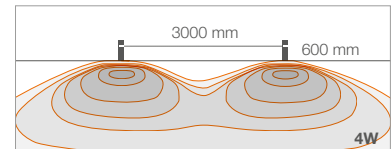

A - Asymmetrical

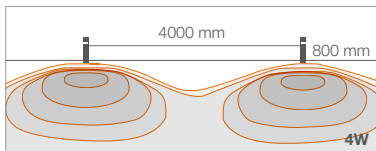

A - Asymmetrical

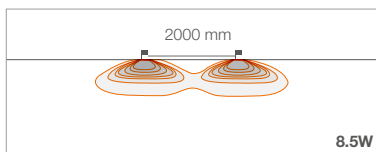

A - Asymmetrical

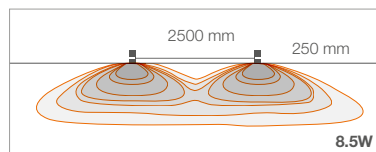

A - Asymmetrical

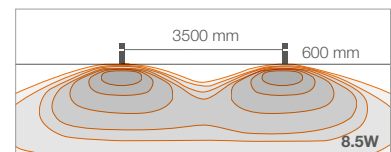

A - Asymmetrical

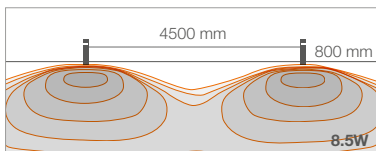



POSITIONING DIAGRAMS

LINEAR 4.1

A - Asymmetrical

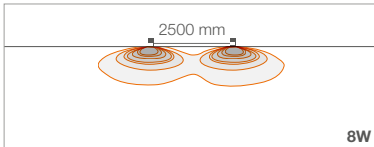

A - Asymmetrical

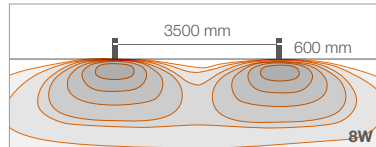

A - Asymmetrical

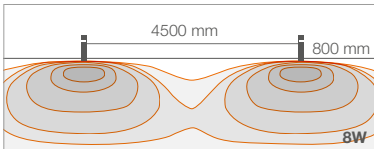

A - Asymmetrical

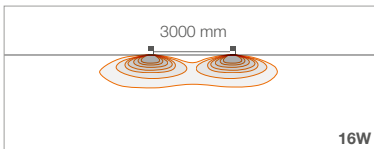

A - Asymmetrical

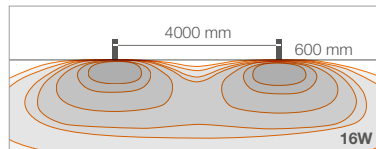

A - Asymmetrical

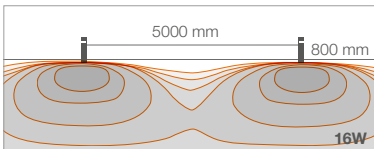

LINEAR 2.2

3000K, 15W, anthracite, height 600 mm

SPOT 1.6

3000K, 2W, 10°

Project by / Archingegno
Light planning by / arch. Mariangela Alicino,
ing. Alfonso Di Liddo
Relais Sant'Agostino, Andria, Italy







OUTDOOR BOLLARDS

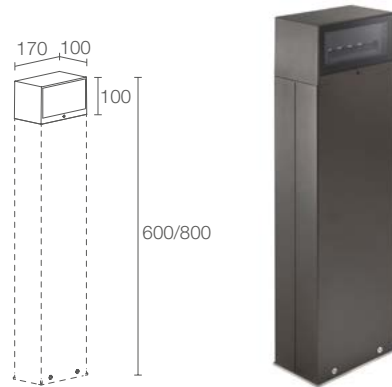
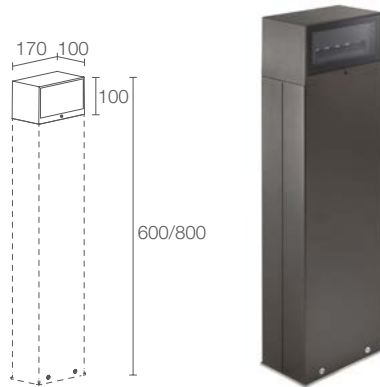

BITTA 1.0



CE ENEC LED TPC kg 4.80 h 600 mm kg 5.70 h 800 mm IP65 IK07

A A+ A++ PID

POWER / POWER SUPPLY CODE

10W 230Vac
BT1010 **A E** White
BT1010 **A F** Grey
BT1010 **A H** Anthracite
BT1010 **A T** Cor-ten

LED COLOUR

F - 2700K
5 - 3000K
9 - 4000K
0 - 5000K

OPTICS

asymmetrical

LUMEN OUTPUT AT SOURCE 727 lm (3000K)

DELIVERED LUMEN OUTPUT 256 lm (3000K)

NO. AND TYPE OF LED 5 power LEDs
 1/4 ANSI BIN, 50000h L90 B10 (Ta 25°C)

MATERIAL head in die-cast aluminium
 column in stainless steel
 screen in serigraphed and transparent,
 tempered extra-clear glass

POWER SUPPLY UNIT built in

POWER CABLES connection box with 0.30 m cable

MOUNTING surface mounted (ground)

ACCESSORIES see p. 487

NOTES Casambi-compatible version,
 controllable with the Casambi app,
 available on request

PHOTOMETRIC DATA see p. 794

BITTA 1.1



CE ENEC LED TPC kg 4.80 h 600 mm kg 5.70 h 800 mm IP65 IK07

A A+ A++ PID

20W 230Vac

BT1110 **A E** White
BT1110 **A F** Grey
BT1110 **A H** Anthracite
BT1110 **A T** Cor-ten

F - 2700K
5 - 3000K
9 - 4000K
0 - 5000K

asymmetrical

1454 lm (3000K)

512 lm (3000K)

10 power LEDs
 1/4 ANSI BIN, 50000h L90 B10 (Ta 25°C)

head in die-cast aluminium
 column in stainless steel
 screen in serigraphed and transparent,
 tempered extra-clear glass

built in

connection box with 0.30 m cable

surface mounted (ground)

see p. 487

Casambi-compatible version,
 controllable with the Casambi app,
 available on request

see p. 794



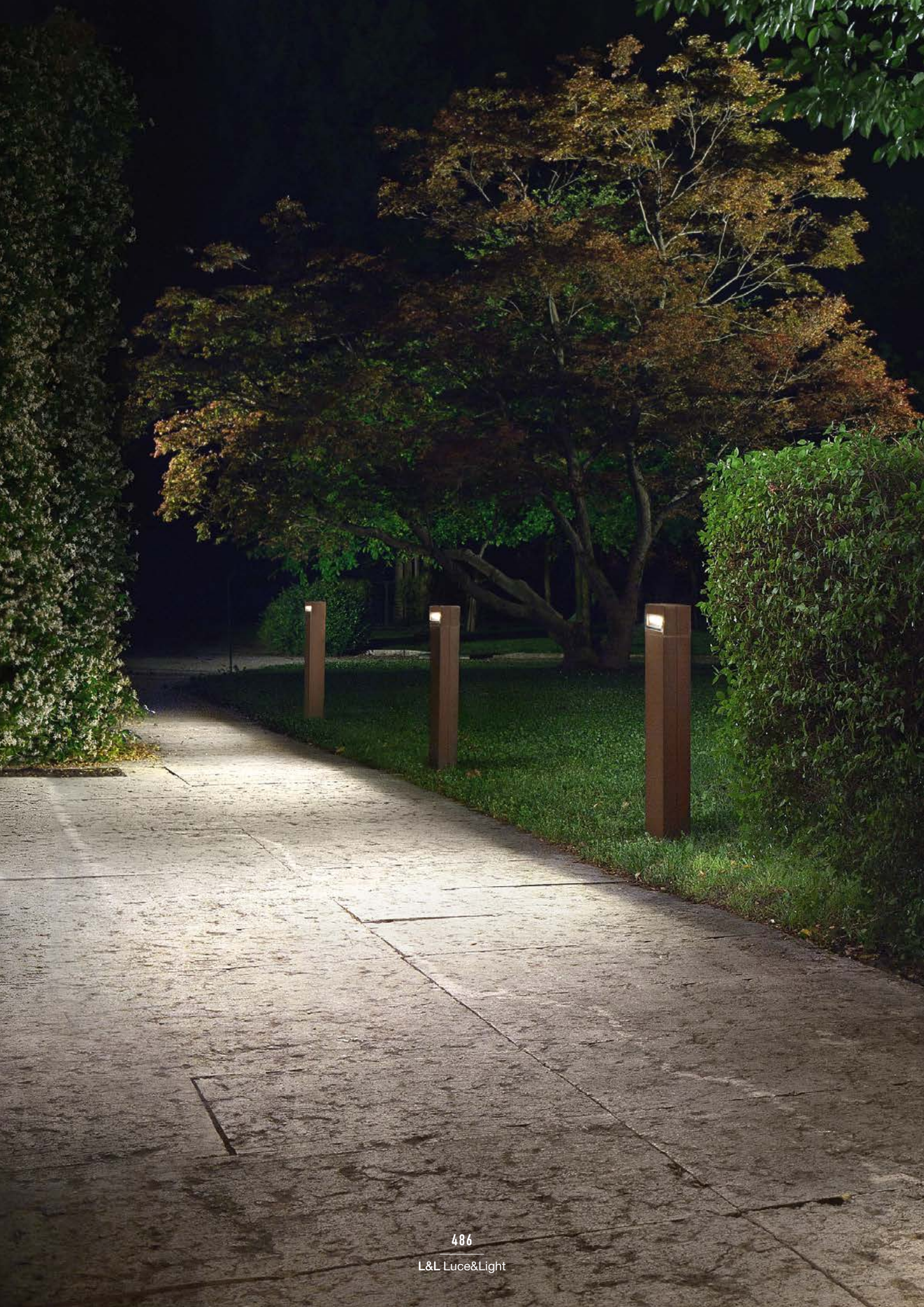



ACCESSORIES AND POSITIONING DIAGRAMS

ACCESSORIES FOR INSTALLATION



h 600 mm including head

- WT60600E** - White
- WT60600F** - Grey
- WT60600H** - Anthracite
- WT60600T** - Cor-ten

Column



h 800 mm including head

- WT60800E** - White
- WT60800F** - Grey
- WT60800H** - Anthracite
- WT60800T** - Cor-ten

Column

RAL finish available on request

POSITIONING DIAGRAMS

BITTA 1.0

A - Asymmetrical

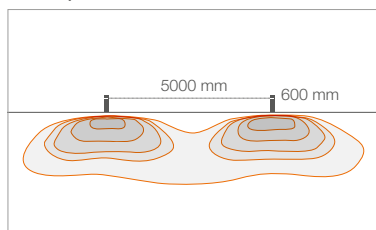

A - Asymmetrical

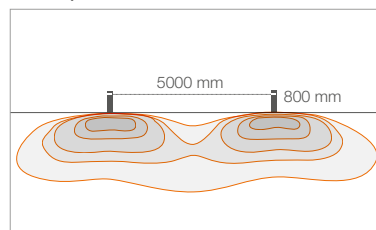



488

L&L Luce&Light



URBAN LIGHTING



POLE MOUNTED

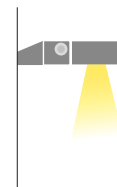

WALL MOUNTED

2700K 3000K 4000K

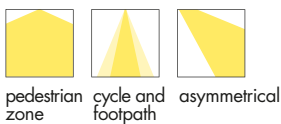

pedestrian zone cycle and footpath asymmetrical



SIRI BLVD 1.0 p. 490
38W 230Vac
ON/OFF
virtual midnight



SIRI BLVD 2.0 p. 491
38W 230Vac
ON/OFF
virtual midnight



SIRI BLVD 3.0 p. 491
38W 230Vac
ON/OFF
virtual midnight

< **SIRI BLVD 3.0**
4000K, 38W, pedestrian-zone optics
with angled wall bracket

✓
SIRI BLVD 3.0
 4000K, 38W, pedestrian-zone optics
 with angled wall bracket

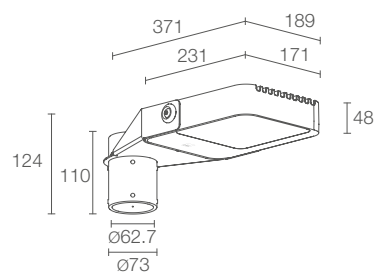
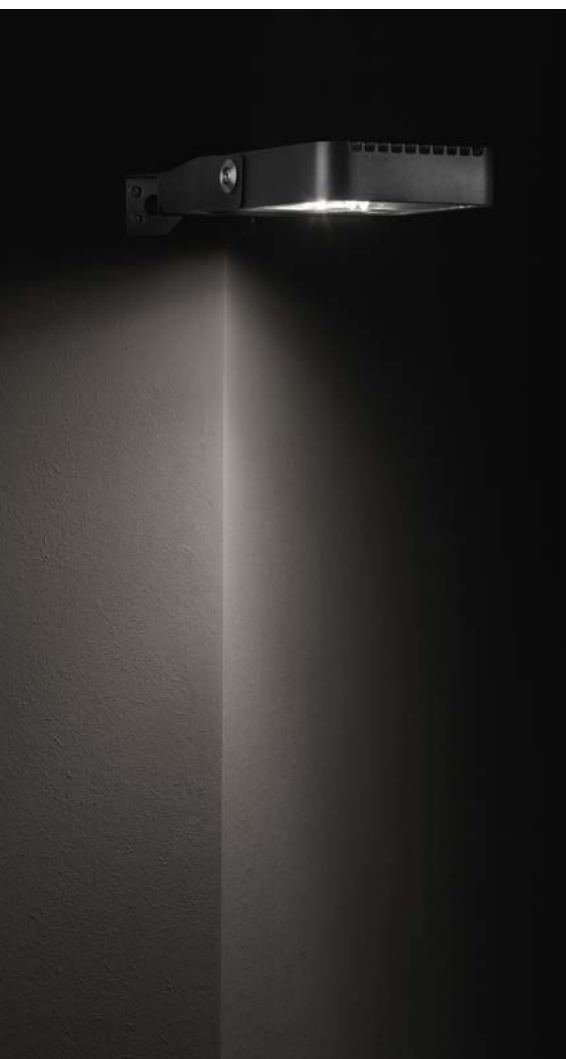

SIRI BLVD 1.0



POWER / POWER SUPPLY CODE	38W 230Vac
	SL1010 ■ ■ H Anthracite
	38W 230Vac VIRTUAL MIDNIGHT
	SL1010 ■ ■ HM Anthracite

■ LED COLOUR	F - 2700K
	5 - 3000K
	9 - 4000K
■ OPTICS	A - pedestrian zone B - asymmetrical C - footpath D - cycle path

LUMEN OUTPUT AT SOURCE	3402 lm (3000K)
DELIVERED LUMEN OUTPUT	2110 lm (3000K, pedestrian zone)
NO. AND TYPE OF LED	4 high-intensity power LEDs 3-step MacAdam, 50000h L90 B10 (Ta 25°C)
MATERIAL	body in die-cast aluminium screen in serigraphed, tempered extra-clear glass
POWER SUPPLY UNIT	built in
POWER CABLES	includes 5 m neoprene cable H05RN-F 2x1.00 Ø7.00 mm
MOUNTING	on pole, Ø60 mm
MAX EXPOSED SURFACE	0.056 m ²
LATERAL SURFACE	0.021 m ²
ACCESSORIES	none
NOTES	double-beam version available on request DALI version available on request Casambi-compatible version, controllable with the Casambi app, available on request
PHOTOMETRIC DATA	see p. 877

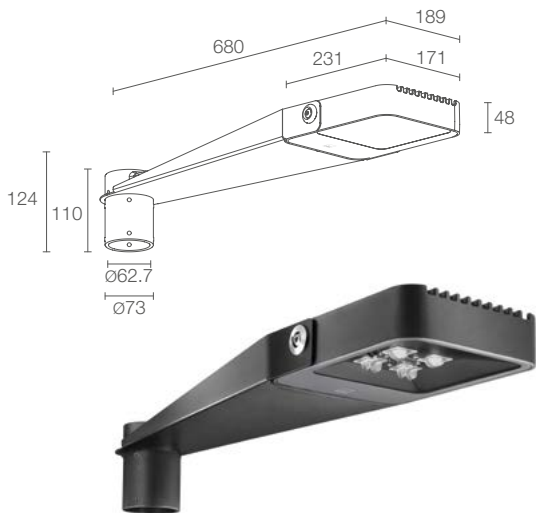

SIRI BLVD 2.0

CE ENEC LED TECH IP66 IK06
 A A+ A++ IPS PID SPD NTC

38W 230Vac
SL2010 Anthracite

38W 230Vac VIRTUAL MIDNIGHT
SL2010 Anthracite

■	F - 2700K 5 - 3000K 9 - 4000K
■	A - pedestrian zone B - asymmetrical C - footpath D - cycle path

3402 lm (3000K)

2110 lm (3000K, pedestrian zone)

4 high-intensity power LEDs
 3-step MacAdam, 50000h L90 B10 (Ta 25°C)

body in die-cast aluminium
 screen in serigraphed, tempered extra-clear glass

built in

includes 5 m neoprene cable
 H05RN-F 2x1.00 Ø7.00 mm

on pole, Ø60 mm

0.098 m²

0.032 m²

none

double-beam version available on request
 DALI version available on request
 Casambi-compatible version, controllable with
 the Casambi app, available on request

see p. 877

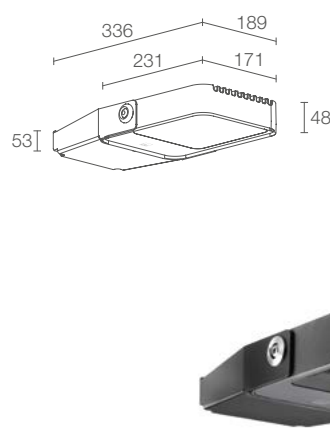

SIRI BLVD 3.0

CE ENEC LED TECH IP66 IK06
 A A+ A++ IPS PID SPD NTC

38W 230Vac
SL3010 Anthracite

38W 230Vac VIRTUAL MIDNIGHT
SL3010 Anthracite

■	F - 2700K 5 - 3000K 9 - 4000K
■	A - pedestrian zone B - asymmetrical C - footpath D - cycle path

3402 lm (3000K)

2110 lm (3000K, pedestrian zone)

4 high-intensity power LEDs
 3-step MacAdam, 50000h L90 B10 (Ta 25°C)

body in die-cast aluminium
 screen in serigraphed, tempered extra-clear glass

built in

includes 5 m neoprene cable
 H05RN-F 2x1.00 Ø7.00 mm

surface mounted (wall)

0.056 m²

0.016 m²

see p. 493

DALI version available on request
 Casambi-compatible version, controllable with
 the Casambi app, available on request

see p. 877



Anthracite





ACCESSORIES AND POSITIONING DIAGRAMS

ACCESSORIES FOR INSTALLATION

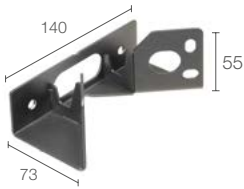

WD0700H - Anthracite

Angled wall bracket
(Siri Blvd 3.0)

POSITIONING DIAGRAMS

SIRI BLVD 2.0

Distance between fixtures: 20 m
Mounted on 4-m pole

A - Pedestrian zone

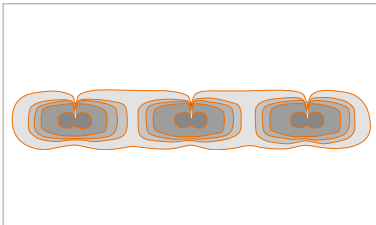

B - Asymmetrical

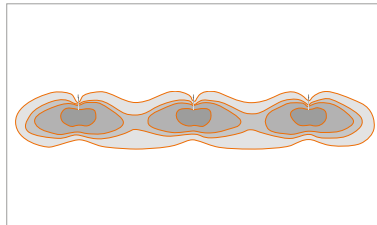

C - Footpath

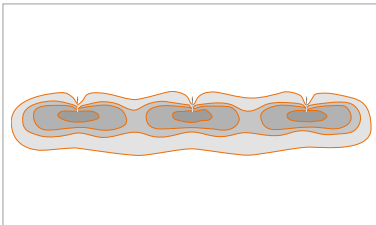

D - Cycle path

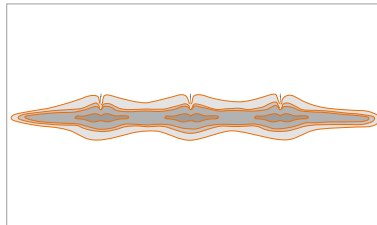

< SIRI BLVD 1.0

3000K, 38W, asymmetrical

Project by / Studio di Architettura
Andrea Abbadessa,
ing. Ignazio Stancanelli,
ing. Giuseppe Malatino
Light planning by / Light Style
Maniace-Ortigia, Syracuse, Italy

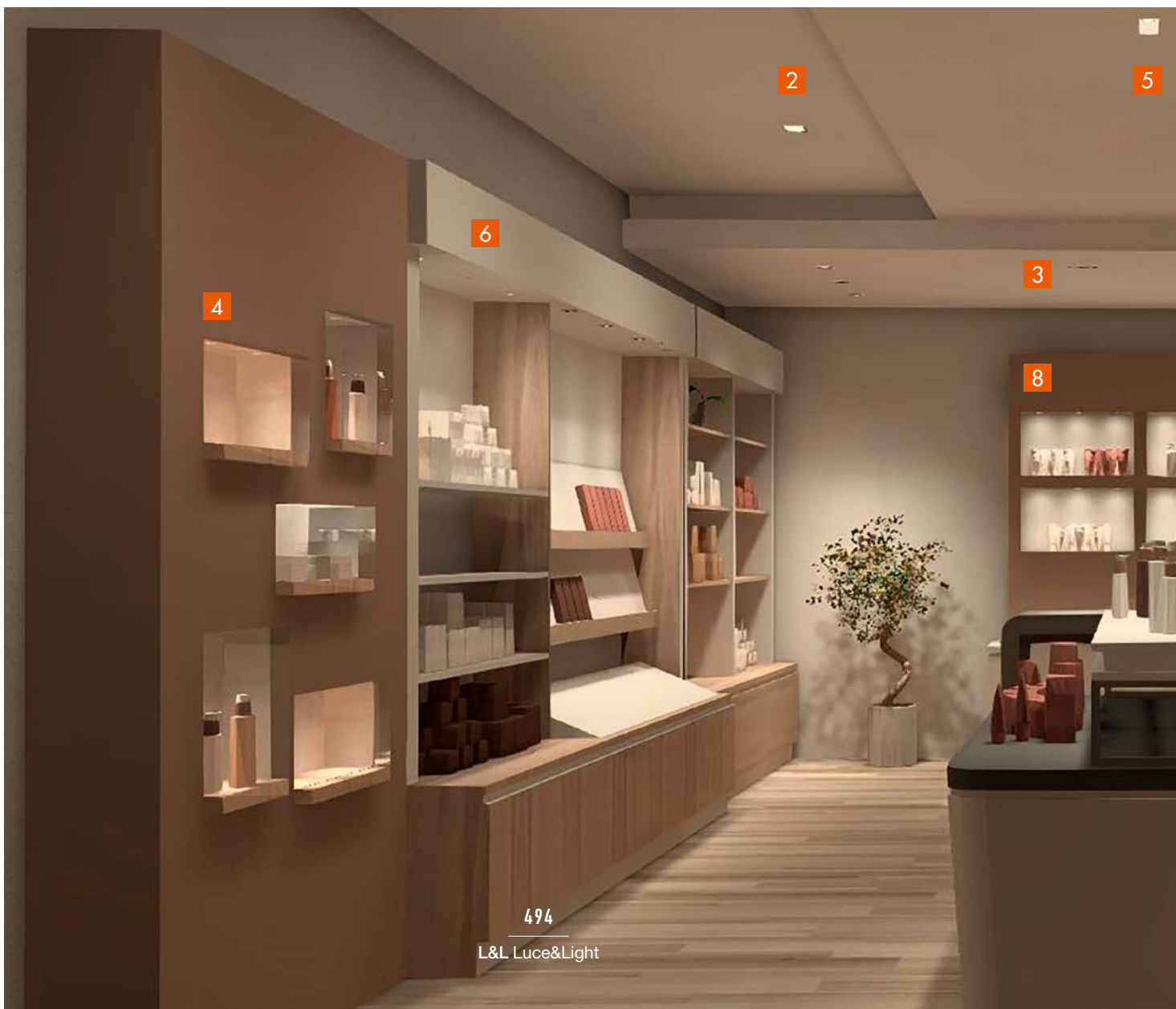

4

6

2

5

3

8

RECESSED FOR INDOOR APPLICATIONS

AMBIENT LIGHTING

COMBINA D p. 498 **1**

TURIS p. 514 **2**

BITPOP p. 530 **3**

ESEM p. 554 **4**

QUAD p. 574 **5**

LED OPTICAL FIBRES p. 580

SHELVES AND NICHES







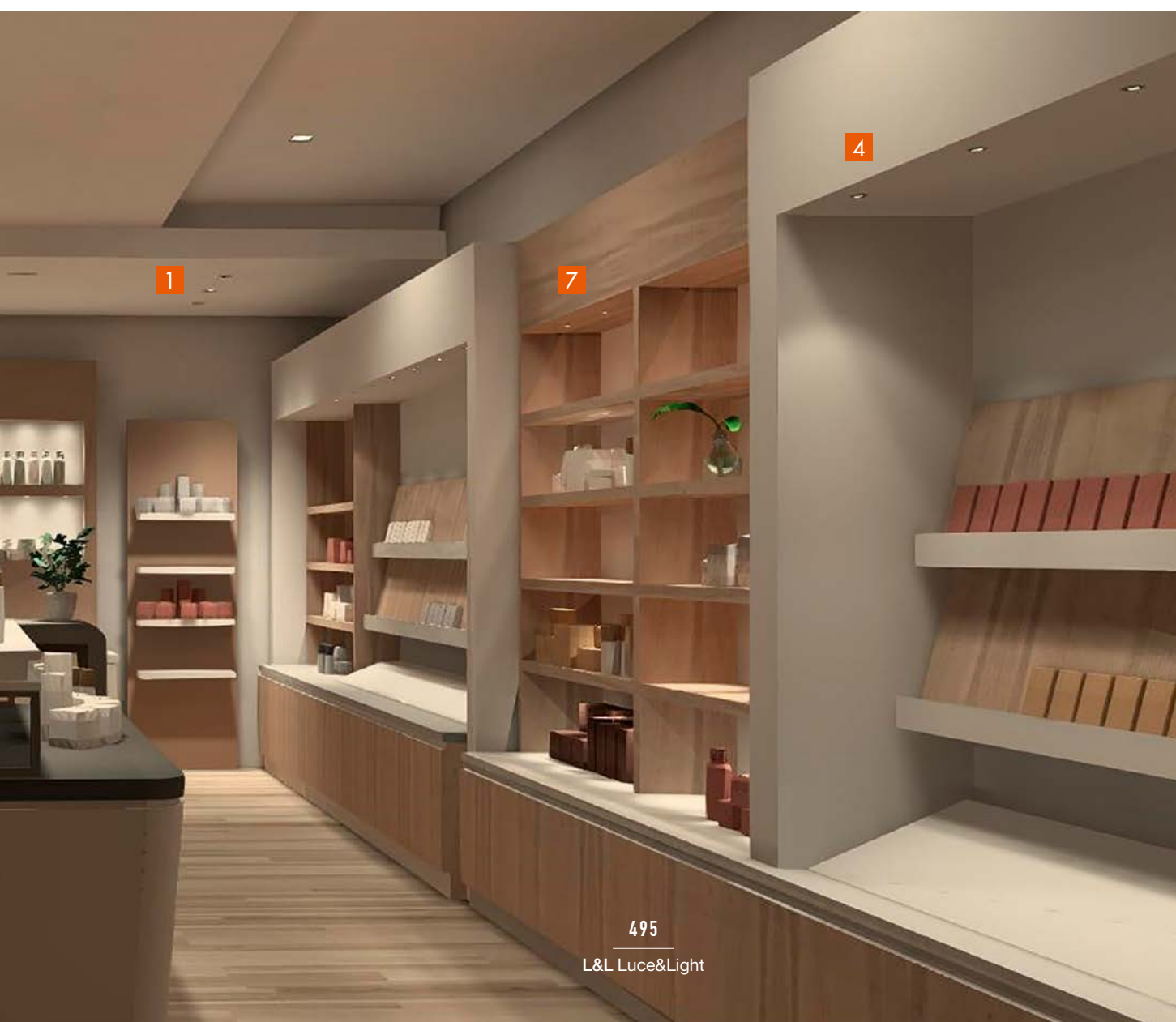





CIAK p. 538 **6**

CAMEO p. 546 **7**







EYES p. 566 **8**







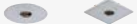









AMBIENT LIGHTING

	AMBIENT LIGHTING	MOUNTING	BEAM	LIGHT COLOUR	POWER
	COMBINA D see p. 498 	CEILING rebated frame flush	DIFFUSE VERSION OPTICS VERSION fixed optics tiltable	 2700K 3000K 4000K	6–29W
	TURIS see p. 514 	CEILING	DIFFUSE VERSION fixed optics	 2700K 3000K 4000K	4.5–30W
	BITPOP see p. 530 	CEILING rebated frame recessed	OPTICS VERSION fixed optics	 2700K 3000K 4000K	6.5– 50W
	ESEM see p. 554 	CEILING WALL SHELVES	OPTICS VERSION fixed optics tiltable	 2700K 3000K 4000K 5000K	2–14W
	QUAD see p. 574 	CEILING	OPTICS VERSION tiltable	 2700K 3000K 4000K 5000K blue RGB	6–18W
	LED OPTICAL FIBRES see p. 580 	CEILING WALL STARRY SKY	POINTS OF LIGHT	 2700K 3000K 4000K 5000K blue RGB	max 3W

SHELVES AND NICHEs

	CIAK see p. 538 	CEILING SHELVES SHOWCASES	OPTICS VERSION adjustable	 2700K 3000K 4000K	1.5–5W
	CAMEO see p. 546 	CEILING FALSE CEILING NICHEs IN PLASTERBOARD	OPTICS VERSION fixed optics tiltable zoom lens	 2700K 3000K 4000K	1.5–5W
	EYES see p. 566 	CEILING SHELVES NICHEs	DIFFUSE VERSION OPTICS VERSION fixed optics	 2700K 3000K 4000K 5000K blue	1–6W

RECESSED FOR INDOOR APPLICATIONS

DELIVERED LUMEN OUTPUT (3000K)	POWER SUPPLY	CONTROL SYSTEM	IP	APPLIANCE CLASS	UNIQUE SELLING POINTS
293–2260 lm	CONSTANT CURRENT (power supply unit not included) max 300mA max 400mA max 500mA max 800mA		IP40 IP44 with filter		version with primer CRI >97
295–1750 lm	CONSTANT VOLTAGE (power supply unit not included) 24Vdc MAINS VOLTAGE (power supply unit included) 230Vac	DALI 0/1-10V mains dimming	IP40	 	
335–2680 lm	CONSTANT VOLTAGE (power supply unit not included) 24Vdc MAINS VOLTAGE (power supply unit included) 230Vac	DALI 0/1-10V	IP40	  	UGR < 10 for 17° and 30° optics
122–957 lm	CONSTANT CURRENT (power supply unit not included) max 350mA / max 500mA CONSTANT VOLTAGE (power supply unit not included) 24Vdc MAINS VOLTAGE (power supply unit included) 230Vac	DALI 0/1-10V mains dimming	IP20 IP40	  	
336 lm	CONSTANT CURRENT (power supply unit not included) max 500mA		IP40		
107 lm	CONSTANT CURRENT (power supply unit not included) max 350mA (RGB light) max 700mA (white/blue light)		IP44		
144–303 lm	CONSTANT CURRENT (power supply unit not included) max 500mA CONSTANT VOLTAGE (power supply unit not included) 24Vdc		IP40		rotatable up to 350° on vertical axis tiltable up to 70° on horizontal axis
50–303 lm	CONSTANT CURRENT (power supply unit not included) max 500mA CONSTANT VOLTAGE (power supply unit not included) 24Vdc		IP40		
54–115 lm	CONSTANT CURRENT (power supply unit not included) max 350mA / max 700mA CONSTANT VOLTAGE (power supply unit not included) 24Vdc		IP40		

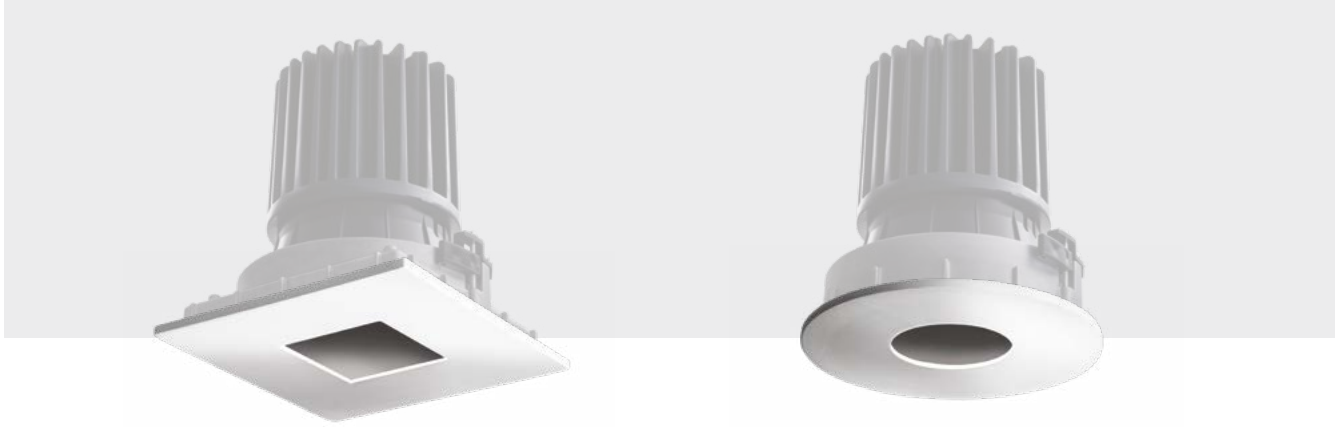

1 CHOOSE THE FIXTURE BODY

FIXED BODY



ADJUSTABLE BODY



2 CHOOSE THE RETAINING BEZEL

ROUND REBATED



RETAINING BEZEL
FOR INSTALLATION

ROUND FLUSH WITH CEILING



RETAINING BEZEL
FOR INSTALLATION

3 LASTLY, CHOOSE THE COVER

ROUND



FLAT COVER



SHALLOW COVER



DEEP COVER
only compatible with the fixed body

CHOOSE COMBINATION USING THE ONLINE CONFIGURATOR AT WWW.LUCELIGHT.IT

INDOOR RECESSED DOWNLIGHTS BUILD THE VERSION YOU WANT IN THREE STEPS

SQUARE REBATED



RETAINING BEZEL
FOR INSTALLATION

SQUARE FLUSH WITH CEILING



RETAINING BEZEL
FOR INSTALLATION

SQUARE



FLAT COVER



SHALLOW COVER



DEEP COVER
only compatible with the fixed body



COMBINA D

INTERCHANGEABLE INDOOR RECESSED DOWNLIGHTS FOR SHOWROOMS, OFFICES AND RETAIL

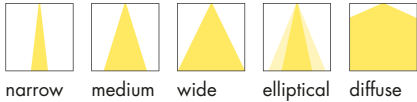

narrow medium wide elliptical diffuse



2700K 3000K 4000K

FIXED OPTICS

Ø 70 mm



Ø 85 mm



Ø 136 mm



Ø 200 mm



70x70 mm



85x85 mm



136x136 mm



200x200 mm



COMBINA D 1.0

p. 504
max 6W max 500mA

COMBINA D 2.0

p. 506
max 11W max 300mA

COMBINA D 3.0

p. 508
max 15W max 400mA

COMBINA D 4.0

p. 510
max 29W 800mA

KIT COMBINA D 1.0

p. 512
8W 230Vac

KIT COMBINA D 2.0

p. 513
17W 230Vac

TILTABLE OPTICS

Ø 70 mm



Ø 85 mm



Ø 136 mm



Ø 200 mm



70x70 mm



85x85 mm



136x136 mm



200x200 mm



COMBINA D 1.1

p. 504
max 6W max 500mA

COMBINA D 2.1

p. 506
max 11W max 300mA

COMBINA D 3.1

p. 508
max 15W max 400mA

COMBINA D 4.1

p. 510
max 29W 800mA

< COMBINA D 2.0
3000K, 11W, 30°
COMBINA D 2.1
3000K, 11W, 30°-25° + elliptical filter
black, flat, round cover,
installed flush with ceiling

Courtesy of / Désirée Divani



deep round cover



shallow round cover



flat round cover



deep square cover



shallow square cover



flat square cover

COMBINA D CAN RESPOND TO CHANGING LIGHTING NEEDS THANKS TO ITS UNIQUE CUTOUT HOLE AND INTERCHANGEABLE ELEMENTS. AT ANY TIME, THE FIXED BODY CAN BE REPLACED WITH THE ADJUSTABLE VERSION, THE SHAPE AND FINISH OF THE COVER CAN BE CHANGED, AND THE LIGHT OUTPUT CAN BE ALTERED BY ADDING OPTICAL FILTERS

RETAINING BEZEL

ENABLES INSTALLATION TO BE REBATED OR FLUSH WITH CEILING

FLAT AND SHALLOW COVERS

COMBINED WITH RECESSED OPTICS, THESE PRODUCE A LIGHT OUTPUT THAT PROVIDES HIGH VISUAL COMFORT WITH A UGR <13, WHILE THE DEEP VERSION HAS A UGR <19

OPTICAL ACCESSORIES

THE OPTICAL FILTERS ALTER THE OPTICS' LIGHT EFFECTS TO PRODUCE A DIFFUSE OR ELLIPTICAL OUTPUT. ALL FILTERS CAN BE STILL APPLIED TO DOWNLIGHTS AFTER INSTALLATION BECAUSE OF THE SPECIAL HOUSING PROVIDED IN THE FIXTURE'S COVER

CRI >97 AND TM-30 MAXIMUM COLOUR RENDITION THANKS TO LED LIGHT SOURCES WITH CRI >90 AND CRI >97

COMBINA D 2 / 3 / 4

REMOTE PHOSPHOR TECHNOLOGY AND 2-STEP MACADAM GUARANTEE COLOUR-BRIGHTNESS CONSISTENCY OVER TIME

COLOR VECTOR GRAPHIC

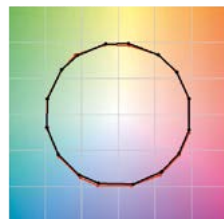

Reference Measured

UNIQUE SELLING POINTS



RAL FINISH
ON REQUEST



THE ADJUSTABLE VERSIONS OF COMBINA D ALLOW THE BODY TO BE ROTATED THROUGH 350° AND TILTED THROUGH 30° TO DIRECT THE LIGHT BEAM PRECISELY



THE PRIMER COATING MEANS THE COVER CAN BE FINISHED IN THE SAME PAINT AS THE CEILING, SO THAT THE FIXTURE BLENDS INTO THE BACKGROUND



EASY TO WIRE BECAUSE ELECTRICAL CABLES CAN BE CONNECTED DIRECTLY TO THE CONNECTOR

COMBINA D 1

BUILD THE VERSION YOU WANT

1. FIXTURE BODY



COMBINA D 1.0

Required installation accessories,
not included



POWER / POWER SUPPLY CODE

max 6W max 500mA
CC10201000 0 0 0

LED COLOUR

F - 2700K
5 - 3000K
9 - 4000K

OPTICS

flat/shallow cover:	deep cover:
S - 16°	S - 16°
M - 22°	M - 23°
L - 33°	L - 42°

CRI

CRI >90

LUMEN OUTPUT AT SOURCE 637 lm (3000K, 500mA)

DELIVERED LUMEN OUTPUT 293 lm (3000K, 500mA, 16°)

NO. AND TYPE OF LED 1 high-intensity power LED
3-step MacAdam, 50000h L90 B10 (Ta 25°C)

MATERIAL body in die-cast aluminium and Bayblend bezel and cover in die-cast aluminium

POWER SUPPLY UNIT not included, see p. 904

POWER CABLES includes 2x0.30 m single-core PVC cables

WIRING series

MOUNTING recessed (ceiling)

FEATURES UGR <13 for versions with flat and shallow covers
UGR <19 for versions with deep cover

NOTES easy to wire
the electrical cables can be attached directly to the connector, making the product easier to install

PHOTOMETRIC DATA see p. 811 and 812

COMBINA D 1.1

Required installation accessories,
not included



max 6W max 500mA
CC11201000 0 0 0

F - 2700K
5 - 3000K
9 - 4000K

S - 16° tiltable ±30°
M - 22° tiltable ±30°
L - 33° tiltable ±30°

CRI >90

LUMEN OUTPUT AT SOURCE 637 lm (3000K, 500mA)

DELIVERED LUMEN OUTPUT 293 lm (3000K, 500mA, 16°)

NO. AND TYPE OF LED 1 high-intensity power LED
3-step MacAdam, 50000h L90 B10 (Ta 25°C)

MATERIAL body in die-cast aluminium and Bayblend bezel and cover in die-cast aluminium

POWER SUPPLY UNIT not included, see p. 904

POWER CABLES includes 2x0.30 m single-core PVC cables

WIRING series

MOUNTING recessed (ceiling)

FEATURES UGR <13

NOTES easy to wire
the electrical cables can be attached directly to the connector, making the product easier to install

PHOTOMETRIC DATA see p. 811 and 812

2. RETAINING BEZEL

Round bezel
for installation **flush with ceiling**



WGCC10A1F
∅78 mm

Square bezel
for installation **flush with ceiling**



WGCC10A2F
78x78 mm

Round bezel
for **rebated** installation



WGCC10A1T
∅60 mm

Square bezel
for **rebated** installation



WGCC10A2T
60x60 mm

3. COVER

Flat round cover



WZCC1010E
White
WZCC1010N
Black
WZCC1010Z
Antique bronze
WZCC10108
Primer

Shallow round cover



WZCC1030E
White
WZCC1030N
Black
WZCC1030Z
Antique bronze
WZCC10308
Primer

Deep round cover



WZCC1050E
White
WZCC1050N
Black
WZCC1050Z
Antique bronze
WZCC10508
Primer
(Combina D 1.0)

Flat square cover



WZCC1020E
White
WZCC1020N
Black
WZCC1020Z
Antique bronze
WZCC10208
Primer

Shallow square cover



WZCC1040E
White
WZCC1040N
Black
WZCC1040Z
Antique bronze
WZCC10408
Primer

Deep square cover



WZCC1060E
White
WZCC1060N
Black
WZCC1060Z
Antique bronze
WZCC10608
Primer
(Combina D 1.0)

4. ACCESSORIES

Honeycomb louvre



WHCC10A1
round cover: flat,
shallow, deep
square cover: deep
WHCC10A2
square cover:
flat, shallow

Diffuser filter



WRCC10R1D
round cover: flat,
shallow, deep
square cover: deep
WRCC10S1D
square cover:
flat, shallow

Elliptical filter



WRCC10R1W
round cover: flat,
shallow, deep
square cover: deep
WRCC10S1W
square cover:
flat, shallow

Transparent IP44 screen



WRCC10R1T
round cover: flat,
shallow, deep
square cover: deep
WRCC10S1T
square cover:
flat, shallow

COMBINA D 2

BUILD THE VERSION YOU WANT

1. FIXTURE BODY



COMBINA D 2.0

Required installation accessories, not included



POWER / POWER SUPPLY CODE	max 11W max 300mA CC2020 000 0 0 0
CRI	1 - CRI >90 2 - CRI >97 (only 2700K, 3000K)
LED COLOUR	F - 2700K 5 - 3000K 9 - 4000K
OPTICS	S - 25° M - 30° L - 36°

LUMEN OUTPUT AT SOURCE	960 lm (3000K, 300mA, CRI >90)
DELIVERED LUMEN OUTPUT	756 lm (3000K, 300mA, 36°, CRI >90)
NO. AND TYPE OF LED	1 high-intensity power LED 2-step MacAdam, 50000h L90 B10 (Ta 25°C)
MATERIAL	body in die-cast aluminium and Bayblend bezel and cover in die-cast aluminium
POWER SUPPLY UNIT	not included, see p. 904
POWER CABLES	includes 2x0.30 m single-core PVC cables
WIRING	series
MOUNTING	recessed (ceiling)
FEATURES	UGR <13 for versions with flat and shallow covers UGR <19 for versions with deep cover
NOTES	easy to wire the electrical cables can be attached directly to the connector, making the product easier to install
PHOTOMETRIC DATA	see p. 812 and 813

COMBINA D 2.1

Required installation accessories, not included



POWER / POWER SUPPLY CODE	max 11W max 300mA CC2120 000 0 0 0
CRI	1 - CRI >90 2 - CRI >97 (only 2700K, 3000K)
LED COLOUR	F - 2700K 5 - 3000K 9 - 4000K
OPTICS	S - 25° tiltable ±30° M - 30° tiltable ±30° L - 36° tiltable ±30°

LUMEN OUTPUT AT SOURCE	960 lm (3000K, 300mA, CRI >90)
DELIVERED LUMEN OUTPUT	756 lm (3000K, 300mA, 36°, CRI >90)
NO. AND TYPE OF LED	1 high-intensity power LED 2-step MacAdam, 50000h L90 B10 (Ta 25°C)
MATERIAL	body in die-cast aluminium and Bayblend bezel and cover in die-cast aluminium
POWER SUPPLY UNIT	not included, see p. 904
POWER CABLES	includes 2x0.30 m single-core PVC cables
WIRING	series
MOUNTING	recessed (ceiling)
FEATURES	UGR <13
NOTES	easy to wire the electrical cables can be attached directly to the connector, making the product easier to install
PHOTOMETRIC DATA	see p. 812 and 813

2. RETAINING BEZEL

Round bezel
for installation **flush with ceiling**



WGCC20A1F
Ø93 mm

Square bezel
for installation **flush with ceiling**



WGCC20A2F
92x92 mm

Round bezel
for **rebated** installation



WGCC20A1T
Ø75 mm

Square bezel
for **rebated** installation



WGCC20A2T
75x75 mm

3. COVER

Flat round cover



WZCC2010E
White
WZCC2010N
Black
WZCC2010Z
Antique bronze
WZCC20108
Primer

Shallow round cover



WZCC2030E
White
WZCC2030N
Black
WZCC2030Z
Antique bronze
WZCC20308
Primer

Deep round cover



WZCC2050E
White
WZCC2050N
Black
WZCC2050Z
Antique bronze
WZCC20508
Primer
(Combina D 2.0)

Flat square cover



WZCC2020E
White
WZCC2020N
Black
WZCC2020Z
Antique bronze
WZCC20208
Primer

Shallow square cover



WZCC2040E
White
WZCC2040N
Black
WZCC2040Z
Antique bronze
WZCC20408
Primer

Deep square cover



WZCC2060E
White
WZCC2060N
Black
WZCC2060Z
Antique bronze
WZCC20608
Primer
(Combina D 2.0)

4. ACCESSORIES

Honeycomb louvre



WHCC20A1
round cover: flat,
shallow, deep
square cover: deep
WHCC20A2
square cover:
flat, shallow

Diffuser filter



WRCC20R1D
round cover: flat,
shallow, deep
square cover: deep
WRCC20S1D
square cover:
flat, shallow

Elliptical filter



WRCC20R1W
round cover: flat,
shallow, deep
square cover: deep
WRCC20S1W
square cover:
flat, shallow

Transparent IP44 screen



WRCC20R1T
round cover: flat,
shallow, deep
square cover: deep
WRCC20S1T
square cover:
flat, shallow

COMBINA D 3

BUILD THE VERSION YOU WANT

1. FIXTURE BODY

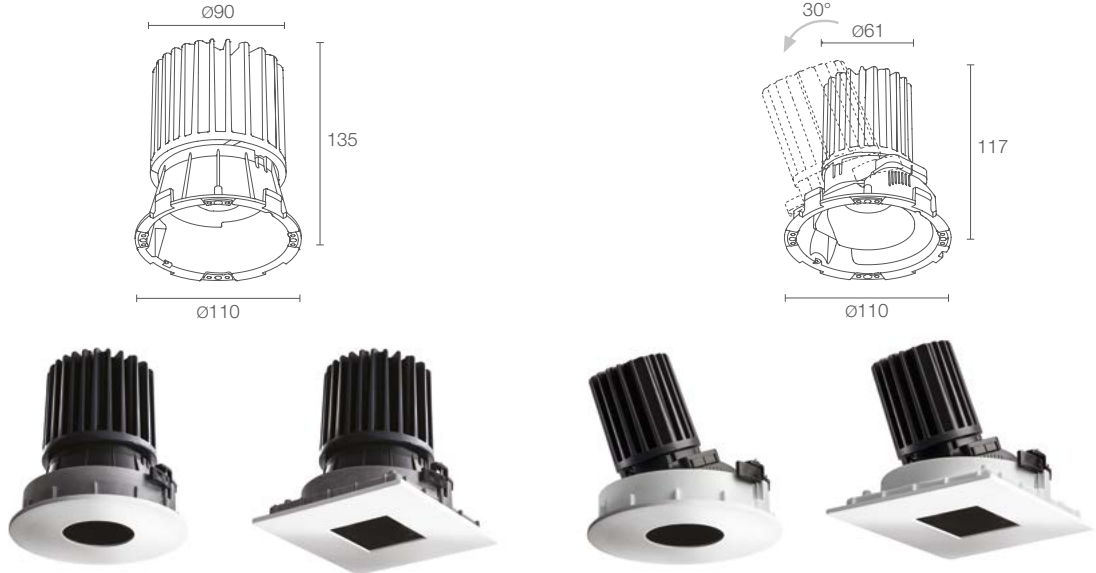

COMBINA D 3.0

Required installation accessories, not included



POWER / POWER SUPPLY CODE	max 15W max 400mA CC3020 ■ 000 ■ 0 ■ 0
CRI	1 - CRI >90 2 - CRI >97 (only 2700K, 3000K)
LED COLOUR	F - 2700K 5 - 3000K 9 - 4000K
OPTICS	S - 18° M - 29° L - 36°

LUMEN OUTPUT AT SOURCE	1349 lm (3000K, 400mA, CRI >90)
DELIVERED LUMEN OUTPUT	1094 lm (3000K, 400mA, 36°, CRI >90)
NO. AND TYPE OF LED	1 high-intensity power LED 2-step MacAdam, 50000h L90 B10 (Ta 25°C)
MATERIAL	body in die-cast aluminium and Bayblend bezel and cover in die-cast aluminium
POWER SUPPLY UNIT	not included, see p. 904
POWER CABLES	includes 2x0.30 m single-core PVC cables
WIRING	series
MOUNTING	recessed (ceiling)
FEATURES	UGR <13 for versions with flat and shallow covers UGR <19 for versions with deep cover
NOTES	easy to wire the electrical cables can be attached directly to the connector, making the product easier to install
PHOTOMETRIC DATA	see p. 814 and 815

COMBINA D 3.1

Required installation accessories, not included



POWER / POWER SUPPLY CODE	max 15W max 400mA CC3120 ■ 000 ■ 0 ■ 0
CRI	1 - CRI >90 2 - CRI >97 (only 2700K, 3000K)
LED COLOUR	F - 2700K 5 - 3000K 9 - 4000K
OPTICS	S - 18° tiltable ±30° M - 29° tiltable ±30° L - 36° tiltable ±30°

LUMEN OUTPUT AT SOURCE	1349 lm (3000K, 400mA, CRI >90)
DELIVERED LUMEN OUTPUT	1094 lm (3000K, 400mA, 36°, CRI >90)
NO. AND TYPE OF LED	1 high-intensity power LED 2-step MacAdam, 50000h L90 B10 (Ta 25°C)
MATERIAL	body in die-cast aluminium and Bayblend bezel and cover in die-cast aluminium
POWER SUPPLY UNIT	not included, see p. 904
POWER CABLES	includes 2x0.30 m single-core PVC cables
WIRING	series
MOUNTING	recessed (ceiling)
FEATURES	UGR <13
NOTES	easy to wire the electrical cables can be attached directly to the connector, making the product easier to install
PHOTOMETRIC DATA	see p. 814 and 815

2. RETAINING BEZEL

Round bezel
for installation **flush with ceiling**



WGCC30A1F
Ø145 mm

Square bezel
for installation **flush with ceiling**



WGCC30A2F
145x145 mm

Round bezel
for **rebated** installation



WGCC30A1T
Ø125 mm

Square bezel
for **rebated** installation



WGCC30A2T
125x125 mm

3. COVER

Flat round cover



WZCC3010E
White
WZCC3010N
Black
WZCC3010Z
Antique bronze
WZCC30108
Primer

Shallow round cover



WZCC3030E
White
WZCC3030N
Black
WZCC3030Z
Antique bronze
WZCC30308
Primer

Deep round cover



WZCC3050E
White
WZCC3050N
Black
WZCC3050Z
Antique bronze
WZCC30508
Primer
(Combina D 3.0)

Flat square cover



WZCC3020E
White
WZCC3020N
Black
WZCC3020Z
Antique bronze
WZCC30208
Primer

Shallow square cover



WZCC3040E
White
WZCC3040N
Black
WZCC3040Z
Antique bronze
WZCC30408
Primer

Deep square cover



WZCC3060E
White
WZCC3060N
Black
WZCC3060Z
Antique bronze
WZCC30608
Primer
(Combina D 3.0)

4. ACCESSORIES

Honeycomb louvre



WHCC30A1
round and
square covers:
flat, shallow

Diffuser filter



WRCC30R1D
round and
square covers:
flat, shallow

Elliptical filter



WRCC30R1W
round and
square covers:
flat, shallow

Transparent IP44 screen



WRCC30R1T
round and
square covers:
flat, shallow

BUILD THE VERSION YOU WANT

1. FIXTURE BODY



COMBINA D 4.0

Required installation accessories, not included



POWER / POWER SUPPLY CODE

max 29W max 800mA
CC4020 ■ 000 ■ 0 ■ 0

■ **CRI**
1 - CRI >90
2 - CRI >97 (only 2700K, 3000K)

■ **LED COLOUR**
F - 2700K
5 - 3000K
9 - 4000K

■ **OPTICS**

flat/shallow cover:	deep cover:
S - 20°	S - 21°
M - 29°	M - 30°
L - 38°	L - 41°

LUMEN OUTPUT AT SOURCE	2829 lm (3000K, 800mA, CRI >90)
DELIVERED LUMEN OUTPUT	2225 lm (3000K, 800mA, 41°, CRI >90)
NO. AND TYPE OF LED	1 high-intensity power LED 2 step MacAdam, 50000h L90 B10 (Ta 25°C)
MATERIAL	body in die-cast aluminium and Bayblend bezel and cover in die-cast aluminium
POWER SUPPLY UNIT	not included, see p. 904
POWER CABLES	includes 2x0.30 m single-core PVC cables
WIRING	series
MOUNTING	recessed (ceiling)
FEATURES	UGR <13 for versions with flat and shallow covers UGR <19 for versions with deep cover
NOTES	easy to wire the electrical cables can be attached directly to the connector, making the product easier to install
PHOTOMETRIC DATA	see p. 815 and 816

COMBINA D 4.1

Required installation accessories, not included



max 29W max 800mA
CC4120 ■ 000 ■ 0 ■ 0

■ **1** - CRI >90
2 - CRI >97 (only 2700K, 3000K)

■ **F** - 2700K
5 - 3000K
9 - 4000K

■ **S** - 20° tiltable ±30°
M - 29° tiltable ±30°
L - 38° tiltable ±30°

LUMEN OUTPUT AT SOURCE	2829 lm (3000K, 800mA, CRI >90)
DELIVERED LUMEN OUTPUT	2260 lm (3000K, 800mA, 20°, CRI >90)
NO. AND TYPE OF LED	1 high-intensity power LED 2-step MacAdam, 50000h L90 B10 (Ta 25°C)
MATERIAL	body in die-cast aluminium and Bayblend bezel and cover in die-cast aluminium
POWER SUPPLY UNIT	not included, see p. 904
POWER CABLES	includes 2x0.30 m single-core PVC cables
WIRING	series
MOUNTING	recessed (ceiling)
FEATURES	UGR <13
NOTES	easy to wire the electrical cables can be attached directly to the connector, making the product easier to install
PHOTOMETRIC DATA	see p. 815 and 816

2. RETAINING BEZEL

Round bezel
for installation **flush with ceiling**



WGCC40A1F
Ø210 mm

Square bezel
for installation **flush with ceiling**



WGCC40A2F
210x210 mm

Round bezel
for **rebated** installation



WGCC40A1T
Ø187 mm

Square bezel
for **rebated** installation



WGCC40A2T
187x187 mm

3. COVER

Flat round cover



WZCC4010E
White
WZCC4010N
Black
WZCC4010Z
Antique bronze
WZCC40108
Primer

Shallow round cover



WZCC4030E
White
WZCC4030N
Black
WZCC4030Z
Antique bronze
WZCC40308
Primer

Deep round cover



WZCC4050E
White
WZCC4050N
Black
WZCC4050Z
Antique bronze
WZCC40508
Primer
(Combina D 4.0)

Flat square cover



WZCC4020E
White
WZCC4020N
Black
WZCC4020Z
Antique bronze
WZCC40208
Primer

Shallow square cover



WZCC4040E
White
WZCC4040N
Black
WZCC4040Z
Antique bronze
WZCC40408
Primer

Deep square cover



WZCC4060E
White
WZCC4060N
Black
WZCC4060Z
Antique bronze
WZCC40608
Primer
(Combina D 4.0)

4. ACCESSORIES

Honeycomb louvre



WHCC40A1
round and
square covers:
flat, shallow

WHCC40A3
round and
square covers:
deep

Diffuser filter



WRCC40R1D
round and
square covers:
flat, shallow

WRCC40R3D
round and
square covers:
deep

Elliptical filter



WRCC40R1W
round and
square covers:
flat, shallow

WRCC40R3W
round and
square covers:
deep

Transparent IP44 screen



WRCC40R1T
round and
square covers:
flat, shallow

WRCC40R3T
round and
square covers:
deep

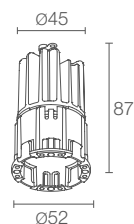

Rebated
installation



Flat cover and rebated installation

KIT COMBINA D 1.0

Ø 130 mm H 170 mm Ø 60 mm 60x60 mm

CE ENEC S LED TECH kg 0.67 IP40 DALI

A A+ A++

POWER / POWER SUPPLY CODE 8W 230Vac Round
KC10 ■ **01R0 F** ■ **0** ■ **B** White
 8W 230Vac Square
KC10 ■ **01B0 N** ■ **0** ■ **B** White

■ CONTROL SYSTEM	0 - on/off D - DALI
■ LED COLOUR	F - 2700K 5 - 3000K 9 - 4000K
■ OPTICS	S - 16° M - 22° L - 33°

CRI CRI >90

LUMEN OUTPUT AT SOURCE	637 lm (3000K)
DELIVERED LUMEN OUTPUT	293 lm (3000K, 16°)
NO. AND TYPE OF LED	high-intensity power LED 3-step MacAdam, 50000h L90 B10 (Ta 25°C)
MATERIAL	body in die-cast aluminium and Bayblend bezel and cover in die-cast aluminium
POWER SUPPLY UNIT	included
POWER CABLES	includes 2x0.30 m single-core cables
MOUNTING	recessed (ceiling)
FEATURES	UGR <13
NOTES	easy to wire the electrical cables can be attached directly to the connector, making the product easier to install
PHOTOMETRIC DATA	see p. 817



White

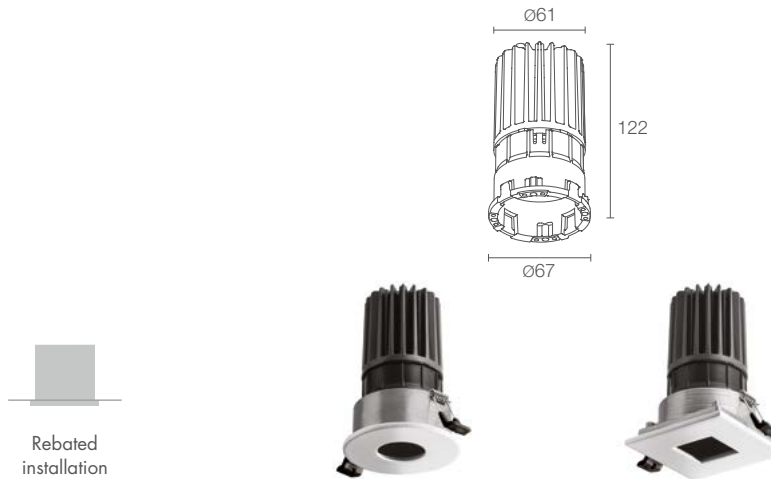

Flat cover and rebated installation

KIT COMBINA D 2.0

Ø 190 mm H 230 mm Ø 75 mm 75x75 mm

CE ENEC S LED TECH kg 0.84 IP40 DALI
A A+ A++

POWER / POWER SUPPLY CODE	17W 230Vac Round KC20 ■ 01RO F ■ 0 ■ B White 17W 230Vac Square KC20 ■ 01BO N ■ 0 ■ B White
CONTROL SYSTEM	0 - on/off D - DALI
LED COLOUR	F - 2700K 5 - 3000K 9 - 4000K
OPTICS	S - 25° M - 30° L - 36°
CRI	CRI >90
LUMEN OUTPUT AT SOURCE	1280 lm (3000K)
DELIVERED LUMEN OUTPUT	1008 lm (3000K, 36°)
NO. AND TYPE OF LED	high-intensity power LED 2-step MacAdam, 50000h L90 B10 (Ta 25°C)
MATERIAL	body in die-cast aluminium and Bayblend bezel and cover in die-cast aluminium
POWER SUPPLY UNIT	included
POWER CABLES	includes 2x0.30 m single-core cables
MOUNTING	recessed (ceiling)
FEATURES	UGR <13
NOTES	easy to wire the electrical cables can be attached directly to the connector, making the product easier to install
PHOTOMETRIC DATA	see p. 817





INDOOR RECESSED DOWNLIGHTS GENERAL LIGHT FOR PRIVATE HOMES



diffuse



2700K 3000K 4000K

4.5W
24VDC
5.5W
230VAC
ON/OFF

5.5W/11W
230VAC
ON/OFF
DALI
0/1-10V
MAINS DIMMING

11W/15W
230VAC
ON/OFF
DALI
0/1-10V
MAINS DIMMING

15W/22W
230VAC
ON/OFF
DALI
0/1-10V
MAINS DIMMING

ROUND COVER



TURIS MINI 1.1 p. 517
Ø44 mm



TURIS 1.1 p. 518
Ø62 mm



TURIS 3.1 p. 524
Ø100 mm



TURIS 5.1 p. 527
Ø128.5 mm

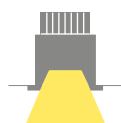

TURIS 1.3 p. 519
Ø62 mm



TURIS 3.3 p. 525
Ø100 mm

SQUARE COVER



TURIS MINI 1.0 p. 517
42x42 mm



TURIS 1.0 p. 518
61x61 mm



TURIS 3.0 p. 524
97x97 mm



TURIS 5.0 p. 527
133x133 mm

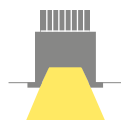

TURIS 1.2 p. 519
61x61 mm



TURIS 3.2 p. 525
97x97 mm



TURIS 2.0 p. 523
70x70 mm



TURIS 4.0 p. 526
94x94 mm



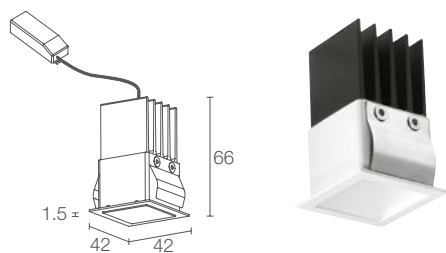

Power supply unit included in the 230Vac version

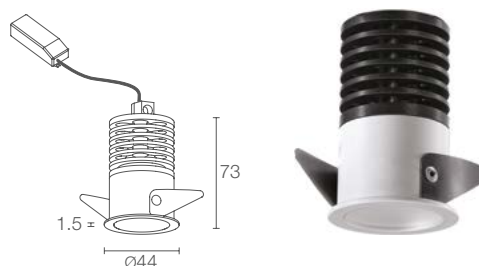

Power supply unit included in the 230Vac version

TURIS MINI 1.0

140x140 mm
H 120 mm

37x37 mm

CE ENEC LED TOP 230Vac 24Vdc kg 0.15 IP40

A A+ A++ CASAMBI

POWER / POWER SUPPLY CODE

5.5W 230Vac
MT1011 D B White

4.5W 24Vdc
MT1001 D B White

LED COLOUR

F - 2700K
5 - 3000K
9 - 4000K
RGB on request

OPTICS

diffuse

LUMEN OUTPUT AT SOURCE	460 lm (3000K)
DELIVERED LUMEN OUTPUT	295 lm (3000K)
NO. AND TYPE OF LED	1 multichip power LED 3-step MacAdam, 50000h L80 B10 (Ta 25°C)
MATERIAL	body in black-anodized aluminium trim in steel screen in one-side-frosted, transparent plexiglass
POWER SUPPLY UNIT	230Vac: included and wired 24Vdc: not included, see p. 904
POWER CABLES	230Vac: includes 0.30 m cable 24Vdc: includes 1.5 m PVC cable FROR 2x0.35/0.35 Ø3.5 mm
MOUNTING	recessed (ceiling)
ACCESSORIES	see p. 529
FEATURES	230Vac: on/off 24Vdc: dimmable with remote PSU CRI >90
PHOTOMETRIC DATA	see p. 896

TURIS MINI 1.1

Ø 140 mm
H 120 mm

Ø 40 mm

CE ENEC LED TOP 230Vac 24Vdc kg 0.15 IP40

A A+ A++ CASAMBI

5.5W 230Vac
MT1111 D B White
MT1111 D C Chrome

4.5W 24Vdc
MT1101 D B White
MT1101 D C Chrome

F - 2700K
5 - 3000K
9 - 4000K
RGB on request

diffuse

LUMEN OUTPUT AT SOURCE	460 lm (3000K)
DELIVERED LUMEN OUTPUT	310 lm (3000K)
NO. AND TYPE OF LED	1 multichip power LED 3-step MacAdam, 50000h L80 B10 (Ta 25°C)
MATERIAL	body in black-anodized aluminium trim in steel screen in one-side-frosted, transparent plexiglass
POWER SUPPLY UNIT	230Vac: included and wired 24Vdc: not included, see p. 904
POWER CABLES	230Vac: includes 0.30 m cable 24Vdc: includes 1.5 m PVC cable FROR 2x0.35/0.35 Ø3.5 mm
MOUNTING	recessed (ceiling)
ACCESSORIES	see p. 529
FEATURES	230Vac: on/off 24Vdc: dimmable with remote PSU CRI >90
PHOTOMETRIC DATA	see p. 896

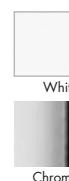

< TURIS MINI 1.1 3000K, 5.5W, chrome

Project by / Studio di Architettura Andrea Abbadessa,
ing. Ignazio Stancanelli, ing. Giuseppe Malatino
Light planning by / Light Style
Maniace-Ortigia, Syracuse, Italy

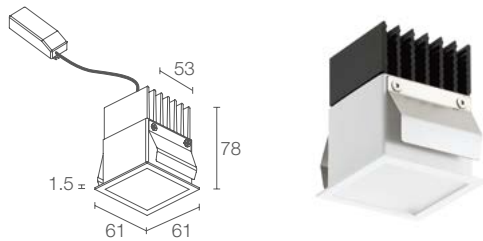

TURIS 1.0

140x140 mm
H 130 mm 56x56 mm

CE CB EAC LED TECH IP40
A A+ A++ DALI PUSH 0/1-10V

POWER SUPPLY CODE

230Vac
TU101 ■ ■ **DB** White
TU101 ■ ■ **DN** Black
TU101 ■ ■ **DG** Grey
 230Vac 0/1-10V + PUSH
TU101 ■ ■ **DBR** White
TU101 ■ ■ **DNR** Black
TU101 ■ ■ **DGR** Grey
 230Vac DALI
TU101 ■ ■ **DBD** White
TU101 ■ ■ **DND** Black
TU101 ■ ■ **DGD** Grey
 230Vac MAINS DIMMING 11W
TU1010 ■ **DBT** White
TU1010 ■ **DNT** Black
TU1010 ■ **DGT** Grey

■ POWER	1 - 5.5W 0 - 11W
■ LED COLOUR	F - 2700K 5 - 3000K 9 - 4000K RGB on request

OPTICS diffuse

LUMEN OUTPUT AT SOURCE	644 lm (3000K, 5.5W) 1251 lm (3000K, 11W)
DELIVERED LUMEN OUTPUT	295 lm (3000K, 5.5W) 1003 lm (3000K, 11W)
NO. AND TYPE OF LED	1 power LED (5.5W version) 4 power LEDs (11W version) 3-step MacAdam, 50000h L80 B10 (Ta 25°C)
MATERIAL	body in black-anodized aluminium trim in steel screen in one-side-frosted, transparent plexiglass
POWER SUPPLY UNIT	included and wired
POWER CABLES	includes 0.30 m cable
MOUNTING	recessed (ceiling)
ACCESSORIES	see p. 529
FEATURES	CRI >90
NOTES	available on request: Casambi-compatible version, controllable with the Casambi app, and version certified ETL
PHOTOMETRIC DATA	see p. 896

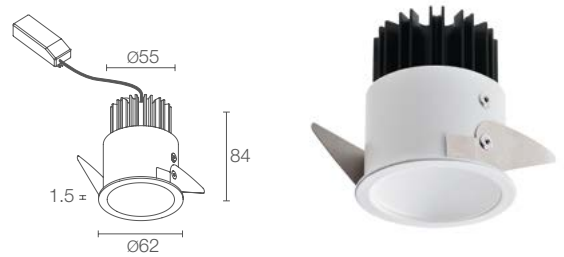

TURIS 1.1

Ø 130 mm
H 130 mm Ø 57 mm

CE CB EAC LED TECH IP40
A A+ A++ DALI PUSH 0/1-10V

230Vac
TU110 ■ ■ **DB** White
TU110 ■ ■ **DN** Black
TU110 ■ ■ **DG** Grey
 230Vac 0/1-10V + PUSH
TU110 ■ ■ **DBR** White
TU110 ■ ■ **DNR** Black
TU110 ■ ■ **DGR** Grey
 230Vac DALI
TU110 ■ ■ **DBD** White
TU110 ■ ■ **DND** Black
TU110 ■ ■ **DGD** Grey
 230Vac MAINS DIMMING 11W
TU1100 ■ **DBT** White
TU1100 ■ **DNT** Black
TU1100 ■ **DGT** Grey

■ POWER	1 - 5.5W 0 - 11W
■ LED COLOUR	F - 2700K 5 - 3000K 9 - 4000K RGB on request

OPTICS diffuse

LUMEN OUTPUT AT SOURCE	644 lm (3000K, 5.5W) 1251 lm (3000K, 11W)
DELIVERED LUMEN OUTPUT	310 lm (3000K, 5.5W) 944 lm (3000K, 11W)
NO. AND TYPE OF LED	1 power LED (5.5W version) 4 power LEDs (11W version) 3-step MacAdam, 50000h L80 B10 (Ta 25°C)
MATERIAL	body in black-anodized aluminium trim in steel screen in one-side-frosted, transparent plexiglass
POWER SUPPLY UNIT	included and wired
POWER CABLES	includes 0.30 m cable
MOUNTING	recessed (ceiling)
ACCESSORIES	see p. 529
FEATURES	CRI >90
NOTES	available on request: Casambi-compatible version, controllable with the Casambi app, and version certified ETL
PHOTOMETRIC DATA	see p. 896

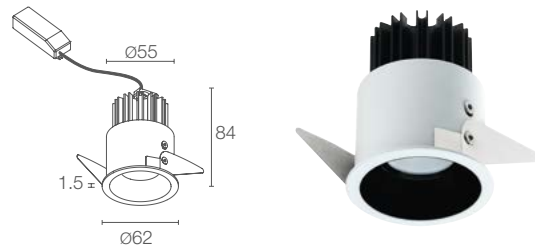
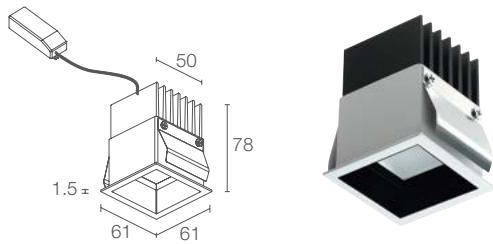

TURIS 1.2

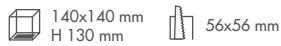

TURIS 1.3

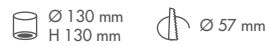

CE CB EAC LED TECH IP40
A A+ A++ DALI PUSH 0/1-10V

CE CB EAC LED TECH IP40
A A+ A++ DALI PUSH 0/1-10V

230Vac
TU121 ■ ■ **DB** White
TU121 ■ ■ **DN** Black
TU121 ■ ■ **DG** Grey

230Vac
TU131 ■ ■ **DB** White
TU131 ■ ■ **DN** Black
TU131 ■ ■ **DG** Grey

230Vac 0/1-10V + PUSH
TU121 ■ ■ **DBR** White
TU121 ■ ■ **DNR** Black
TU121 ■ ■ **DGR** Grey

230Vac 0/1-10V + PUSH
TU131 ■ ■ **DBR** White
TU131 ■ ■ **DNR** Black
TU131 ■ ■ **DGR** Grey

230Vac DALI
TU121 ■ ■ **DBD** White
TU121 ■ ■ **DND** Black
TU121 ■ ■ **DGD** Grey

230Vac DALI
TU131 ■ ■ **DBD** White
TU131 ■ ■ **DND** Black
TU131 ■ ■ **DGD** Grey

230Vac MAINS DIMMING 11W
TU1210 ■ **DBT** White
TU1210 ■ **DNT** Black
TU1210 ■ **DGT** Grey

230Vac MAINS DIMMING 11W
TU1310 ■ **DBT** White
TU1310 ■ **DNT** Black
TU1310 ■ **DGT** Grey

■	1 - 5.5W 0 - 11W
■	F - 2700K 5 - 3000K 9 - 4000K RGB on request

■	1 - 5.5W 0 - 11W
■	F - 2700K 5 - 3000K 9 - 4000K RGB on request

diffuse

diffuse

644 lm (3000K, 5.5W)
1251 lm (3000K, 11W)

644 lm (3000K, 5.5W)
1251 lm (3000K, 11W)

303 lm (3000K, 5.5W)
631 lm (3000K, 11W)

302 lm (3000K, 5.5W)
629 lm (3000K, 11W)

1 power LED (5.5W version)
4 power LEDs (11W version)
3-step MacAdam, 50000h L80 B10 (Ta 25°C)

1 power LED (5.5W version)
4 power LEDs (11W version)
3-step MacAdam, 50000h L80 B10 (Ta 25°C)

body in black-anodized aluminium
trim in steel
screen in one-side-frosted, transparent plexiglass

body in black-anodized aluminium
trim in steel
screen in one-side-frosted, transparent plexiglass

included and wired

included and wired

includes 0.30 m cable

includes 0.30 m cable

recessed (ceiling)

recessed (ceiling)

see p. 529

see p. 529

CRI >90

CRI >90

available on request: Casambi-compatible version, controllable with the Casambi app, and version certified ETL

available on request: Casambi-compatible version, controllable with the Casambi app, and version certified ETL

see p. 896

see p. 896









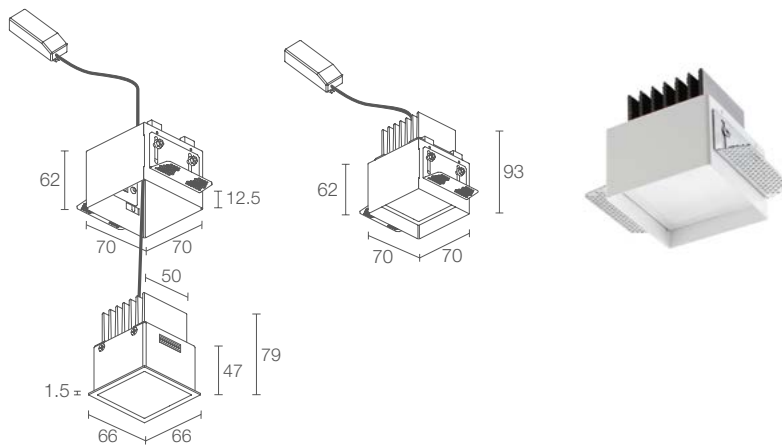

Required outer casing, not included

TURIS 2.0

150x150 mm H 140 mm 70x70 mm

CE CB ENEC LED TECH kg 0.30 IP40
 A A+ A++ DALI PUSH 0/1-10V

POWER SUPPLY CODE

230Vac
TU201 ■ ■ ■ D B
 230Vac 0/1-10V + PUSH
TU201 ■ ■ ■ D BR
 230Vac DALI
TU201 ■ ■ ■ D BD
 230Vac MAINS DIMMING 11W
TU2010 ■ ■ ■ D BT

POWER	1 - 5.5W 0 - 11W
LED COLOUR	F - 2700K 5 - 3000K 9 - 4000K RGB on request
OPTICS	diffuse
LUMEN OUTPUT AT SOURCE	644 lm (3000K, 5.5W) 1251 lm (3000K, 11W)
DELIVERED LUMEN OUTPUT	295 lm (3000K, 5.5W) 1003 lm (3000K, 11W)
NO. AND TYPE OF LED	1 power LED (5.5W version) 4 power LEDs (11W version) 3-step MacAdam, 50000h L80 B10 (Ta 25°C)
MATERIAL	body in black-anodized aluminium trim in steel screen in one-side-frosted, transparent plexiglass
POWER SUPPLY UNIT	included and wired
POWER CABLES	includes 0.30 m cable
MOUNTING	recessed (ceiling)
ACCESSORIES	see p. 529
FEATURES	CRI >90
NOTES	available on request: Casambi-compatible version, controllable with the Casambi app, and version certified ETL
PHOTOMETRIC DATA	see p. 896

< **TURIS 1.0**
3000K, 11W, white

Light planning by / Imat Felco Como
 Executed by / Punto Luce di Simonetti Wimmer
 Photo by / Alessio Tamborini
 Private residence, Como, Italy

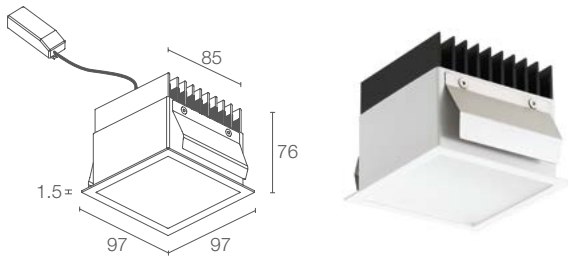

TURIS 3.0

170x170 mm
H 130 mm 90x90 mm

CE CB EAC LED T80 kg 0.71 IP40
A A+ A++ DALI PUSH 0/1-10V

POWER SUPPLY CODE

230Vac
TU301 ■ ■ **D B** White
TU301 ■ ■ **D N** Black
TU301 ■ ■ **D G** Grey

230Vac 0/1-10V + PUSH
TU301 ■ ■ **D BR** White
TU301 ■ ■ **D NR** Black
TU301 ■ ■ **D GR** Grey

230Vac DALI
TU301 ■ ■ **D BD** White
TU301 ■ ■ **D ND** Black
TU301 ■ ■ **D GD** Grey

230Vac MAINS DIMMING
TU301 ■ ■ **D BT** White
TU301 ■ ■ **D NT** Black
TU301 ■ ■ **D GT** Grey

■ POWER	1 - 11W 0 - 15W
■ LED COLOUR	F - 2700K 5 - 3000K 9 - 4000K
OPTICS	diffuse

LUMEN OUTPUT AT SOURCE	1251 lm (3000K, 11W) 1870 lm (3000K, 15W)
DELIVERED LUMEN OUTPUT	975 lm (3000K, 11W) 1463 lm (3000K, 15W)
NO. AND TYPE OF LED	4 power LEDs (11W version) 6 power LEDs (15W version) 3-step MacAdam, 50000h L80 B10 (Ta 25°C)
MATERIAL	body in black-anodized aluminium trim in steel screen in one-side-frosted, transparent plexiglass
POWER SUPPLY UNIT	included and wired
POWER CABLES	includes 0.30 m cable
MOUNTING	recessed (ceiling)
ACCESSORIES	see p. 529
FEATURES	CRI >90
NOTES	available on request: Casambi-compatible version, controllable with the Casambi app, and version certified ETL
PHOTOMETRIC DATA	see p. 897

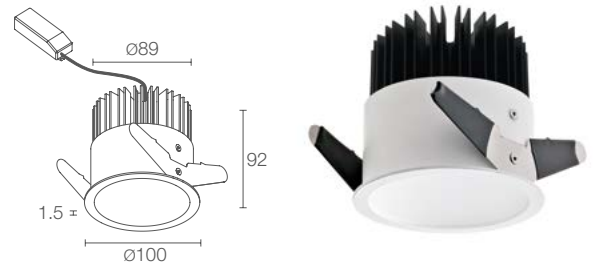

TURIS 3.1

Ø 190 mm
H 160 mm Ø 90 mm

CE CB EAC LED T80 kg 0.67 IP40
A A+ A++ DALI PUSH 0/1-10V

230Vac
TU310 ■ ■ **D B** White
TU310 ■ ■ **D N** Black
TU310 ■ ■ **D G** Grey

230Vac 0/1-10V + PUSH
TU310 ■ ■ **D BR** White
TU310 ■ ■ **D NR** Black
TU310 ■ ■ **D GR** Grey

230Vac DALI
TU310 ■ ■ **D BD** White
TU310 ■ ■ **D ND** Black
TU310 ■ ■ **D GD** Grey

230Vac MAINS DIMMING
TU310 ■ ■ **D BT** White
TU310 ■ ■ **D NT** Black
TU310 ■ ■ **D GT** Grey

■ POWER	1 - 11W 0 - 15W
■ LED COLOUR	F - 2700K 5 - 3000K 9 - 4000K
OPTICS	diffuse

LUMEN OUTPUT AT SOURCE	1251 lm (3000K, 11W) 1870 lm (3000K, 15W)
DELIVERED LUMEN OUTPUT	954 lm (3000K, 11W) 1431 lm (3000K, 15W)
NO. AND TYPE OF LED	4 power LEDs (11W version) 6 power LEDs (15W version) 3-step MacAdam, 50000h L80 B10 (Ta 25°C)
MATERIAL	body in black-anodized aluminium trim in steel screen in one-side-frosted, transparent plexiglass
POWER SUPPLY UNIT	included and wired
POWER CABLES	includes 0.30 m cable
MOUNTING	recessed (ceiling)
ACCESSORIES	see p. 529
FEATURES	CRI >90
NOTES	available on request: Casambi-compatible version, controllable with the Casambi app, and version certified ETL
PHOTOMETRIC DATA	see p. 897

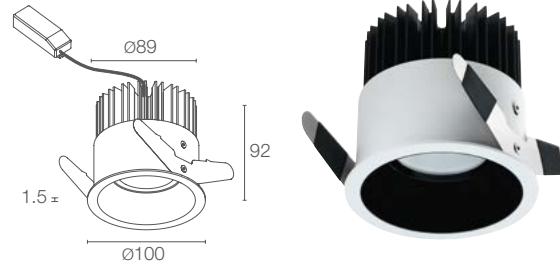
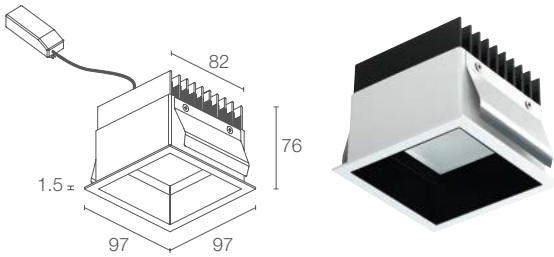

TURIS 3.2

170x170 mm
H 130 mm 90x90 mm

CE CB ENEC LED VIBRO kg 0.71 IP40
A A+ A++ DALI PUSH 0/1-10V

230Vac
TU321 ■ ■ **DB** White
TU321 ■ ■ **DN** Black
TU321 ■ ■ **DG** Grey

230Vac 0/1-10V + PUSH
TU321 ■ ■ **DBR** White
TU321 ■ ■ **DNR** Black
TU321 ■ ■ **DGR** Grey

230Vac DALI
TU321 ■ ■ **DBD** White
TU321 ■ ■ **DND** Black
TU321 ■ ■ **DGD** Grey

230Vac MAINS DIMMING
TU321 ■ ■ **DBT** White
TU321 ■ ■ **DNT** Black
TU321 ■ ■ **DGT** Grey

■ 1 - 11W
■ 0 - 15W

■ **F** - 2700K
■ **5** - 3000K
■ **9** - 4000K

diffuse

1251 lm (3000K, 11W)
 1870 lm (3000K, 15W)

755 lm (3000K, 11W)
 1117 lm (3000K, 15W)

4 power LEDs (11W version)
 6 power LEDs (15W version)
 3-step MacAdam, 50000h L80 B10 (Ta 25°C)

body in black-anodized aluminium
 trim in steel
 screen in one-side-frosted, transparent plexiglass

included and wired

includes 0.30 m cable

recessed (ceiling)

see p. 529

CRI >90

Casambi-compatible version, controllable with the Casambi app, available on request

see p. 897

TURIS 3.3

Ø 190 mm
H 160 mm Ø 90 mm

CE CB ENEC LED VIBRO kg 0.67 IP40
A A+ A++ DALI PUSH 0/1-10V

230Vac
TU331 ■ ■ **DB** White
TU331 ■ ■ **DN** Black
TU331 ■ ■ **DG** Grey

230Vac 0/1-10V + PUSH
TU331 ■ ■ **DBR** White
TU331 ■ ■ **DNR** Black
TU331 ■ ■ **DGR** Grey

230Vac DALI
TU331 ■ ■ **DBD** White
TU331 ■ ■ **DND** Black
TU331 ■ ■ **DGD** Grey

230Vac MAINS DIMMING
TU331 ■ ■ **DBT** White
TU331 ■ ■ **DNT** Black
TU331 ■ ■ **DGT** Grey

■ 1 - 11W
■ 0 - 15W

■ **F** - 2700K
■ **5** - 3000K
■ **9** - 4000K

diffuse

1251 lm (3000K, 11W)
 1870 lm (3000K, 15W)

784 lm (3000K, 11W)
 1160 lm (3000K, 15W)

4 power LEDs (11W version)
 6 power LEDs (15W version)
 3-step MacAdam, 50000h L80 B10 (Ta 25°C)

body in black-anodized aluminium
 trim in steel
 screen in one-side-frosted, transparent plexiglass

included and wired

includes 0.30 m cable

recessed (ceiling)

see p. 529

CRI >90

Casambi-compatible version, controllable with the Casambi app, available on request

see p. 897



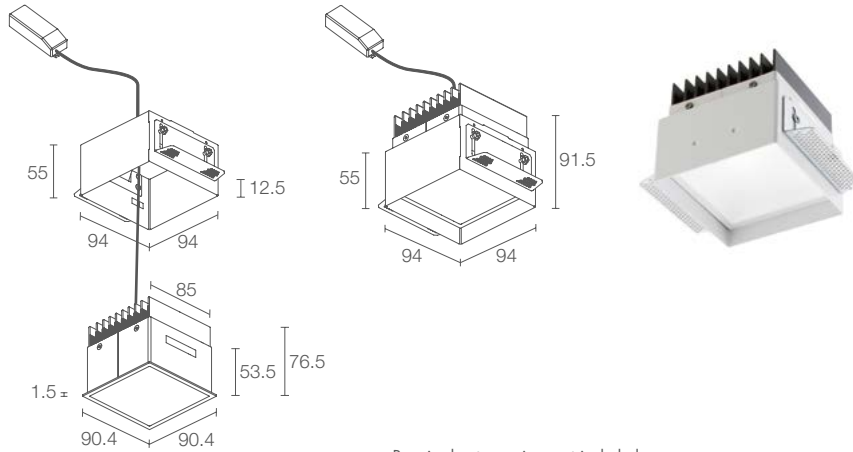

Required outer casing, not included

TURIS 4.0

180x180 mm
H 140 mm

95x95 mm

CE CB ENEC LED TCO

A A+ A++ DALI PUSH 0/1-10V

kg 0.50 IP40

POWER SUPPLY CODE

230Vac
TU401 ■ ■ ■ **D B**

230Vac 0/1-10V + PUSH
TU401 ■ ■ ■ **D BR**

230Vac DALI
TU401 ■ ■ ■ **D BD**

230Vac MAINS DIMMING
TU401 ■ ■ ■ **D BT**

POWER	1 - 11W 0 - 15W
LED COLOUR	F - 2700K 5 - 3000K 9 - 4000K
OPTICS	diffuse

LUMEN OUTPUT AT SOURCE	1251 lm (3000K, 11W) 1870 lm (3000K, 15W)
DELIVERED LUMEN OUTPUT	975 lm (3000K, 11W) 1463 lm (3000K, 15W)
NO. AND TYPE OF LED	4 power LEDs (11W version) 6 power LEDs (15W version) 3-step MacAdam, 50000h L80 B10 (Ta 25°C)
MATERIAL	body in black-anodized aluminium trim in steel screen in one-side-frosted, transparent plexiglass
POWER SUPPLY UNIT	included and wired
POWER CABLES	includes 0.30 m cable
MOUNTING	recessed (ceiling)
ACCESSORIES	see p. 529
FEATURES	CRI >90
NOTES	available on request: Casambi-compatible version, controllable with the Casambi app, and version certified ETL
PHOTOMETRIC DATA	see p. 897

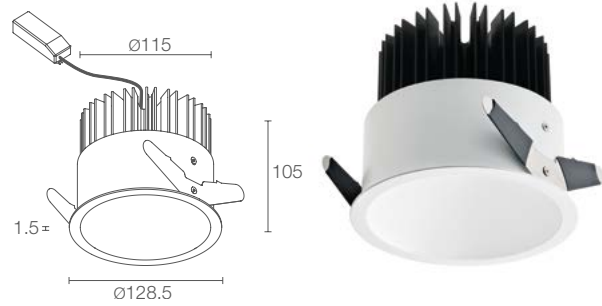
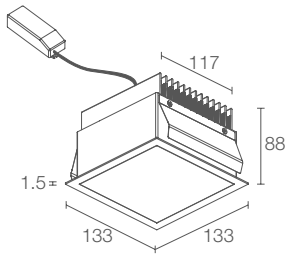

TURIS 5.0

200x200 mm H 130 mm 125x125 mm

CE CB ENEC LED TECH IP40
A A+ A++ DALI PUSH 0/1-10V

POWER SUPPLY CODE

230Vac
TU501 ■ ■ **DB** White
TU501 ■ ■ **DN** Black
TU501 ■ ■ **DG** Grey

230Vac 0/1-10V + PUSH
TU501 ■ ■ **DBR** White
TU501 ■ ■ **DNR** Black
TU501 ■ ■ **DGR** Grey

230Vac DALI + PUSH
TU501 ■ ■ **DBD** White
TU501 ■ ■ **DND** Black
TU501 ■ ■ **DGD** Grey

230Vac MAINS DIMMING
TU501 ■ ■ **DBT** White
TU501 ■ ■ **DNT** Black
TU501 ■ ■ **DGT** Grey

■ POWER	1 - 15W 0 - 22W
■ LED COLOUR	F - 2700K 5 - 3000K 9 - 4000K
OPTICS	diffuse

LUMEN OUTPUT AT SOURCE	1870 lm (3000K, 15W) 2231 lm (3000K, 22W)
DELIVERED LUMEN OUTPUT	1312 lm (3000K, 15W) 1750 lm (3000K, 22W)
NO. AND TYPE OF LED	6 power LEDs (15W version) 8 power LEDs (22W version) 3-step MacAdam, 50000h L80 B10 (Ta 25°C)
MATERIAL	body in black-anodized aluminium trim in steel; screen in one-side-frosted, transparent plexiglass
POWER SUPPLY UNIT	included and wired
POWER CABLES	includes 0.30 m cable
MOUNTING	recessed (ceiling)
FEATURES	CRI >90
NOTES	available on request: Casambi-compatible version, controllable with the Casambi app, and version certified ETL
PHOTOMETRIC DATA	see p. 897

TURIS 5.1

Ø 220 mm H 160 mm Ø 117 mm

CE CB ENEC LED TECH IP40
A A+ A++ DALI PUSH 0/1-10V

230Vac
TU510 ■ ■ **DB** White
TU510 ■ ■ **DN** Black
TU510 ■ ■ **DG** Grey

230Vac 0/1-10V + PUSH
TU510 ■ ■ **DBR** White
TU510 ■ ■ **DNR** Black
TU510 ■ ■ **DGR** Grey

230Vac DALI + PUSH
TU510 ■ ■ **DBD** White
TU510 ■ ■ **DND** Black
TU510 ■ ■ **DGD** Grey

230Vac MAINS DIMMING
TU510 ■ ■ **DBT** White
TU510 ■ ■ **DNT** Black
TU510 ■ ■ **DGT** Grey

■ POWER	1 - 15W 0 - 22W
■ LED COLOUR	F - 2700K 5 - 3000K 9 - 4000K
OPTICS	diffuse

LUMEN OUTPUT AT SOURCE	1870 lm (3000K, 15W) 2231 lm (3000K, 22W)
DELIVERED LUMEN OUTPUT	1312 lm (3000K, 15W) 1750 lm (3000K, 22W)
NO. AND TYPE OF LED	6 power LEDs (15W version) 8 power LEDs (22W version) 3-step MacAdam, 50000h L80 B10 (Ta 25°C)
MATERIAL	body in black-anodized aluminium trim in steel screen in one-side-frosted, transparent plexiglass
POWER SUPPLY UNIT	included and wired
POWER CABLES	includes 0.30 m cable
MOUNTING	recessed (ceiling)
FEATURES	CRI >90
NOTES	available on request: Casambi-compatible version, controllable with the Casambi app, and version certified ETL
PHOTOMETRIC DATA	see p. 897



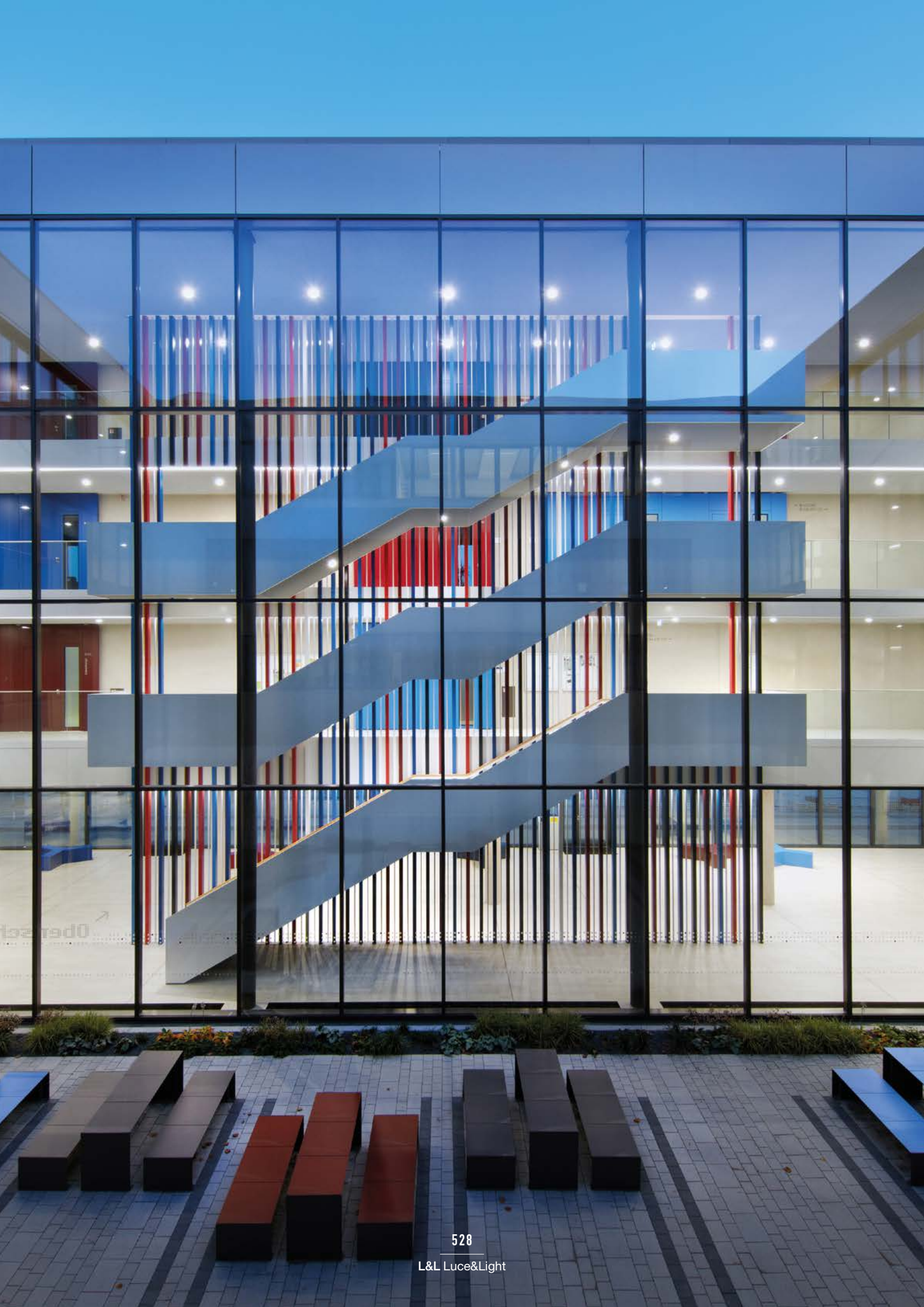

ACCESSORIES

ACCESSORIES FOR INSTALLATION

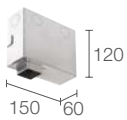

WC3107
Outer casing for solid walls
(Turis Mini 1.0)

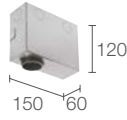

WC3108
Outer casing for solid walls
(Turis Mini 1.1)

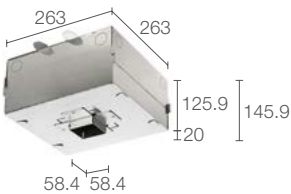

WC3101
Outer casing for solid walls
(Turis 1.0 / 1.2)

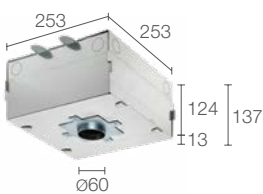

WC3105
Outer casing for solid walls
(Turis 1.1 / 1.3)

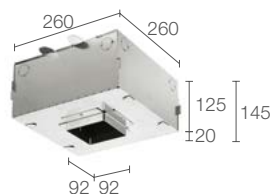

WC3103
Outer casing for solid walls
(Turis 3.0 / 3.2)



WC3106
Outer casing for solid walls
(Turis 3.1 / 3.3)

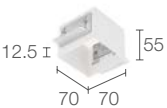

WC3102
Outer casing for plasterboard
(Turis 2.0)

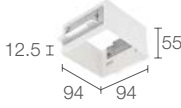

WC3104
Outer casing for plasterboard
(Turis 4.0)

< **TURIS 3.0**
4000K, 15W, white

Project by / ARGE DD-TOL
AB Raum und Bau GmbH,
AB Fuchs und Rudolph,
AGZ Zimmermann, Arch. GmbH
Contractor / STESAD GmbH
Photo by / Robert Gommlich
Gymnasium Tolkewitz, Dresden, Germany



INDOOR RECESSED DOWNLIGHTS FOR OFFICES AND WORK SPACES

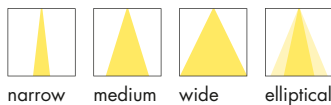

narrow medium wide elliptical



2700K 3000K 4000K



RECESSED

1 OPTICS



BITPOP 1.0 p. 532

6.5W 24Vdc
8W 230Vac
ON/OFF, DALI, 0/1-10V

2 OPTICS IN A LINE



BITPOP 2.1 p. 533

10W 230Vac
15W 230Vac
ON/OFF, DALI, 0/1-10V

4 OPTICS IN A SQUARE

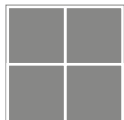

BITPOP 2.2 p. 533

18W 230Vac
26W 230Vac
ON/OFF, DALI, 0/1-10V

4 OPTICS IN A LINE



BITPOP 4.1 p. 534

18W 230Vac
26W 230Vac
ON/OFF, DALI, 0/1-10V

8 OPTICS IN A LINE



BITPOP 8.1 p. 535

35W 230Vac
50W 230Vac
ON/OFF, DALI, 0/1-10V

CEILING MOUNTED

BITPOP C p. 650

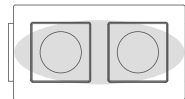
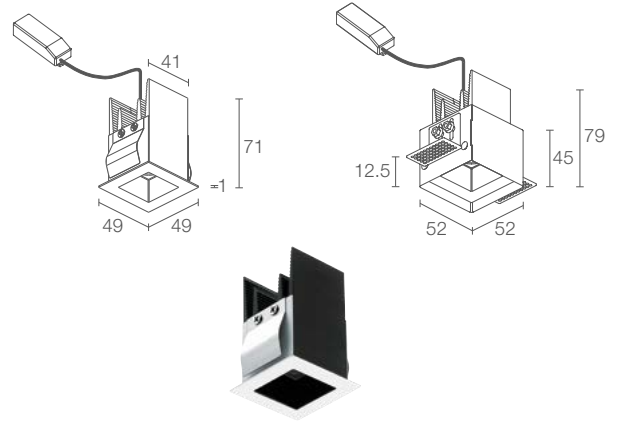

17°x45° optics

Power supply unit included in the 230Vac version
Outer casing for deep-set installation not included

BITPOP 1.0

140x140 mm
H 125 mm

43x43 mm



kg 0.26 IP40

A A+ A++ DALI PUSH 0/1-10V

POWER / POWER SUPPLY CODE

6.5W 24Vdc

BP1000 ■ ■ **W O** White – white interior
BP1000 ■ ■ **B O** White – black interior
BP1000 ■ ■ **N O** Black – black interior

8W 230Vac

BP1010 ■ ■ **W ■** White – white interior
BP1010 ■ ■ **B ■** White – black interior
BP1010 ■ ■ **N ■** Black – black interior

LED COLOUR

1F - 2700K CRI >90
15 - 3000K CRI >90
09 - 4000K CRI 80

OPTICS

S - 17°
F - 30°
L - 42°
W - 17°x45°

CONTROL SYSTEM

O - on/off
R - 0/1-10V + PUSH
D - DALI + PUSH

LUMEN OUTPUT AT SOURCE 480 lm (3000K)

DELIVERED LUMEN OUTPUT 335 lm (3000K, 30°)

NO. AND TYPE OF LED 1 high-intensity power LED
3-step MacAdam, 50000h L85 B10 (Ta 25°C)

MATERIAL body in black-anodized aluminium
trim in steel

POWER SUPPLY UNIT 24Vdc: not included, see p. 904
230Vac: included and wired

POWER CABLES 24Vdc: includes 1.5 m PVC cable
FROR 2x0.35 Ø3.5 mm
230Vac: includes 0.30 m cable

MOUNTING recessed (ceiling: rebated or deep set)

ACCESSORIES see p. 537

FEATURES UGR < 10 for the 17° and 30° optics

NOTES ceiling-mounted version: Bitpop C, p. 650
Casambi-compatible version, controllable with the Casambi app, available on request

PHOTOMETRIC DATA see p. 791

▼

BITPOP 2.2
3000K, 26W, 17°, white
rebated installation

BITPOP 2.2
3000K, 26W, 17°, white
deep-set installation with outer casing

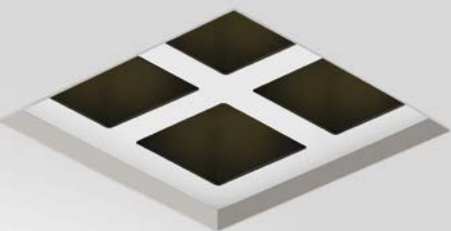
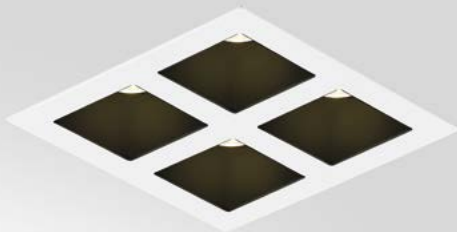

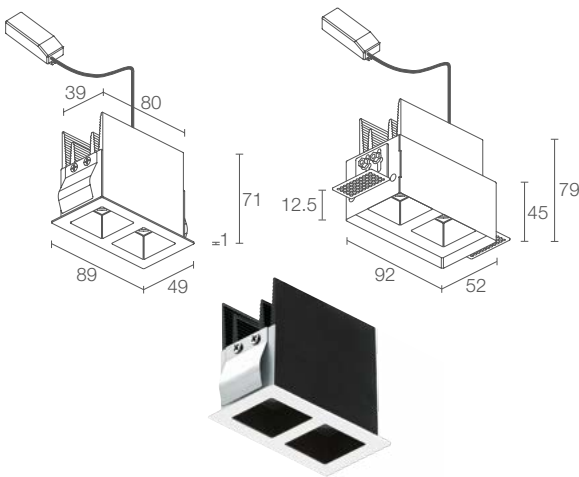

Outer casing for deep-set installation not included

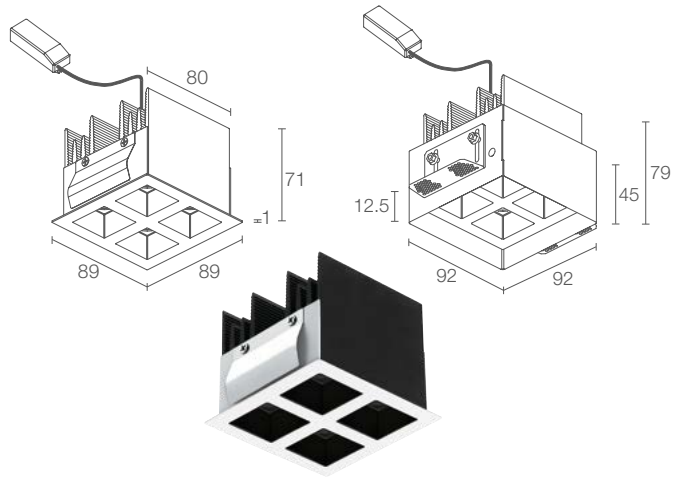

Outer casing for deep-set installation not included

BITPOP 2.1

170x90 mm
H 130 mm
83x42 mm



kg 0.35 IP40

A A+ A++ DALI PUSH 0/1-10V

10W 230Vac

BP2110 W White – white interior
BP2110 B White – black interior
BP2110 N Black – black interior

15W 230Vac

BP2111 W White – white interior
BP2111 B White – black interior
BP2111 N Black – black interior

1F - 2700K CRI >90
15 - 3000K CRI >90
09 - 4000K CRI 80

S - 17°
F - 30°
L - 42°
W - 17°x45°

O - on/off
R - 0/1-10V + PUSH
D - DALI

700 lm (3000K, 10W)
 960 lm (3000K, 15W)

496 lm (3000K, 30°, 10W)
 670 lm (3000K, 30°, 15W)

2 high-intensity power LEDs
 3-step MacAdam, 50000h L85 B10 (Ta 25°C)

body in black-anodized aluminium
 trim in steel

included and wired

includes 0.30 m cable

recessed (ceiling: rebated or deep set)

see p. 537

UGR < 10 for the 17° and 30° optics

ceiling-mounted version: Bitpop C, p. 650
 Casambi-compatible version, controllable with the
 Casambi app, available on request

see p. 791

BITPOP 2.2

170x170 mm
H 130 mm
82x82 mm



kg 0.96 IP40

A A+ A++ DALI PUSH 0/1-10V

18W 230Vac

BP2210 W White – white interior
BP2210 B White – black interior
BP2210 N Black – black interior

26W 230Vac

BP2211 W White – white interior
BP2211 B White – black interior
BP2211 N Black – black interior

1F - 2700K CRI >90
15 - 3000K CRI >90
09 - 4000K CRI 80

S - 17°
F - 30°
L - 42°
W - 17°x45°

O - on/off
R - 0/1-10V + PUSH
D - DALI + PUSH

1400 lm (3000K, 18W)
 1920 lm (3000K, 26W)

992 lm (3000K, 30°, 18W)
 1340 lm (3000K, 30°, 26W)

4 high-intensity power LEDs
 3-step MacAdam, 50000h L85 B10 (Ta 25°C)

body in black-anodized aluminium
 trim in steel

included and wired

includes 0.30 m cable

recessed (ceiling: rebated or deep set)

see p. 537

UGR < 10 for the 17° and 30° optics

ceiling-mounted version: Bitpop C, p. 650
 Casambi-compatible version, controllable with the
 Casambi app, available on request

see p. 792



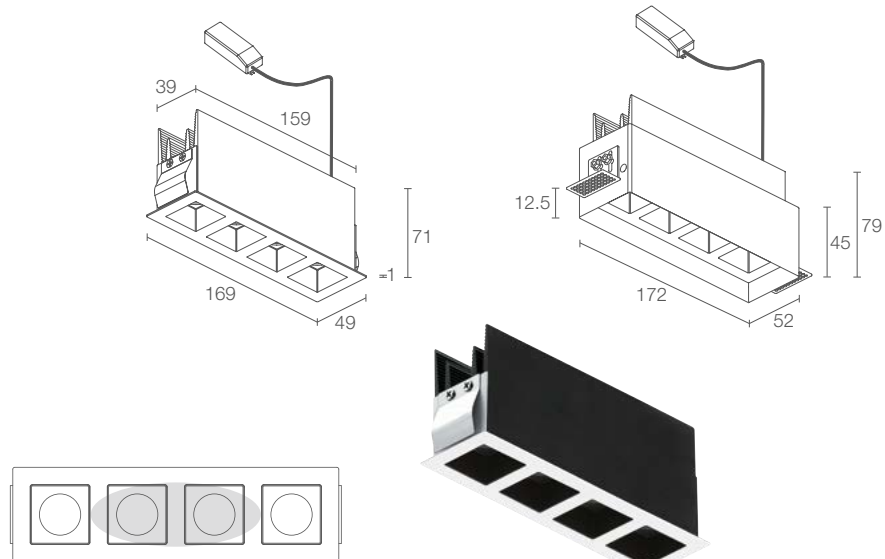

17°x45° optics

Outer casing for deep-set installation not included

BITPOP 4.1

340x100 mm
H 130 mm

162x42 mm

CE CB EAC S LED TECH kg 0.42 IP40
A A+ A++ DALI PUSH 0/1-10V

POWER / POWER SUPPLY CODE

18W 230Vac

BP4110 ■ ■ **W** ■ White – white interior
BP4110 ■ ■ **B** ■ White – black interior
BP4110 ■ ■ **N** ■ Black – black interior

26W 230Vac

BP4111 ■ ■ **W** ■ White – white interior
BP4111 ■ ■ **B** ■ White – black interior
BP4111 ■ ■ **N** ■ Black – black interior

LED COLOUR

1F - 2700K CRI >90
15 - 3000K CRI >90
09 - 4000K CRI 80

OPTICS

S - 17°
F - 30°
L - 42°
W - 17°x45°

CONTROL SYSTEM

O - on/off
R - 0/1-10V + PUSH
D - DALI + PUSH

LUMEN OUTPUT AT SOURCE 1400 lm (3000K, 18W)
 1920 lm (3000K, 26W)

DELIVERED LUMEN OUTPUT 992 lm (3000K, 30°, 18W)
 1340 lm (3000K, 30°, 26W)

NO. AND TYPE OF LED 4 high-intensity power LEDs
 3-step MacAdam, 50000h L85 B10 (Ta 25°C)

MATERIAL body in black-anodized aluminium
 trim in steel

POWER SUPPLY UNIT included and wired

POWER CABLES includes 0.30 m cable

MOUNTING recessed (ceiling: rebated or deep set)

ACCESSORIES see p. 537

FEATURES UGR < 10 for the 17° and 30° optics

NOTES ceiling-mounted version: Bitpop C, p. 650
 Casambi-compatible version, controllable with the
 Casambi app, available on request

PHOTOMETRIC DATA see p. 792

v

BITPOP 4.1
 3000K, 26W, 17°, white
 rebated installation

BITPOP 4.1
 3000K, 26W, 17°, white
 deep-set installation with outer casing



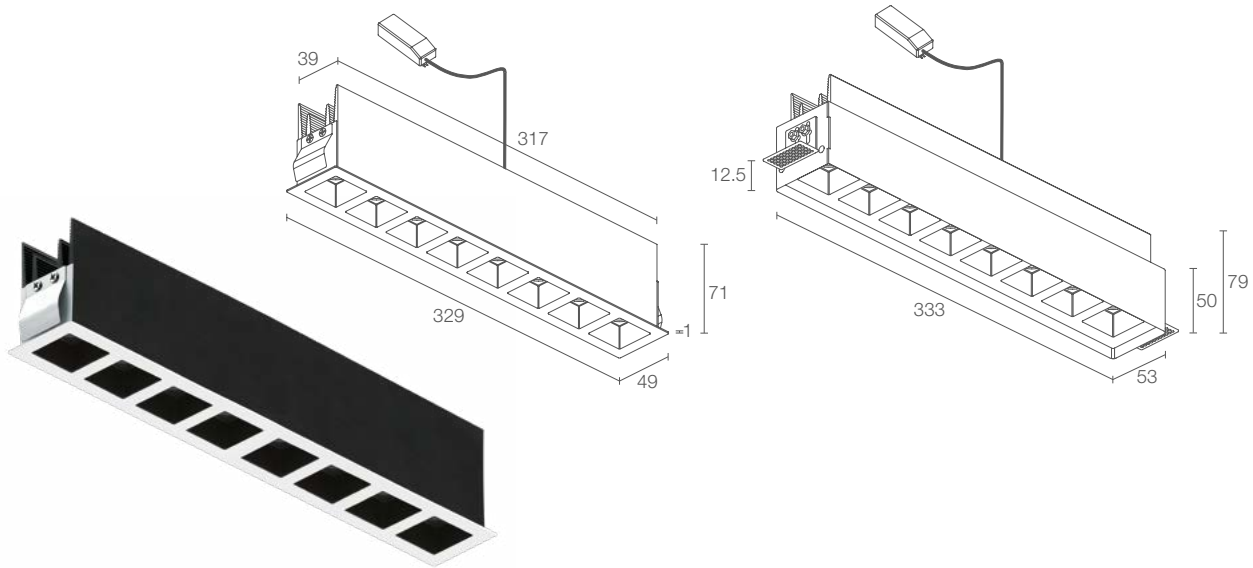

Outer casing for deep-set installation not included

BITPOP 8.1

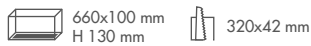

35W 230Vac

- BP8110** ■ ■ **W** ■ White – white interior
- BP8110** ■ ■ **B** ■ White – black interior
- BP8110** ■ ■ **N** ■ Black – black interior

50W 230Vac

- BP8111** ■ ■ **W** ■ White – white interior
- BP8111** ■ ■ **B** ■ White – black interior
- BP8111** ■ ■ **N** ■ Black – black interior

- **1F** - 2700K CRI >90
- **15** - 3000K CRI >90
- **09** - 4000K CRI 80

- **S** - 17°
- **F** - 30°
- **L** - 42°
- **W** - 17°x45°

- **O** - on/off
- **R** - 0/1-10V + PUSH
- **D** - DALI + PUSH

2800 lm (3000K, 35W)
3840 lm (3000K, 50W)

1984 lm (3000K, 30°, 35W)
2680 lm (3000K, 30°, 50W)

8 high-intensity power LEDs
3-step MacAdam, 50000h L85 B10 (Ta 25°C)

body in black-anodized aluminium
trim in steel

included and wired

includes 0.30 m cable

recessed (ceiling: rebated or deep set)

see p. 537

UGR < 10 for the 17° and 30° optics

ceiling-mounted version: Bitpop C, p. 650
Casambi-compatible version, controllable with the
Casambi app, available on request

see p. 792





ACCESSORIES

ACCESSORIES FOR INSTALLATION

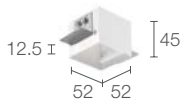

WC8703 - White
WC8703N - Black

Outer casing for deep-set installation in plasterboard ceilings (Bitpop 1.0)

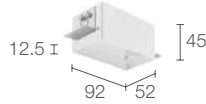

WC8713 - White
WC8713N - Black

Outer casing for deep-set installation in plasterboard ceilings (Bitpop 2.1)



WC8704 - White
WC8704N - Black

Outer casing for deep-set installation in plasterboard ceilings (Bitpop 2.2)

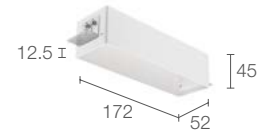

WC8705 - White
WC8705N - Black

Outer casing for deep-set installation in plasterboard ceilings (Bitpop 4.1)

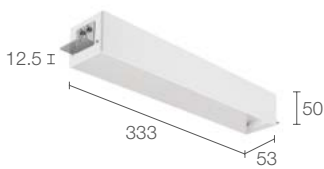

WC8710 - White
WC8710N - Black

Outer casing for deep-set installation in plasterboard ceilings (Bitpop 8.1)

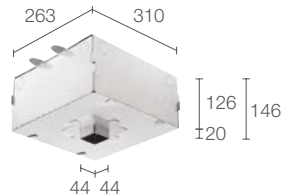

WC8700

Outer casing for rebated installation in solid ceilings (Bitpop 1.0)

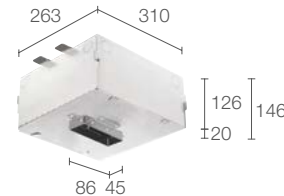

WC8712

Outer casing for rebated installation in solid ceilings (Bitpop 2.1)

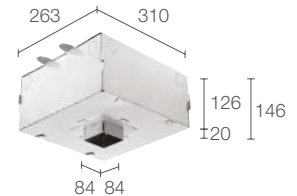

WC8701

Outer casing for rebated installation in solid ceilings (Bitpop 2.2)

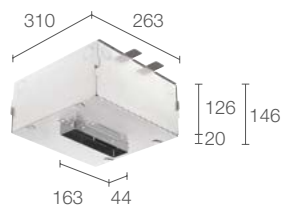

WC8702

Outer casing for rebated installation in solid ceilings (Bitpop 4.1)

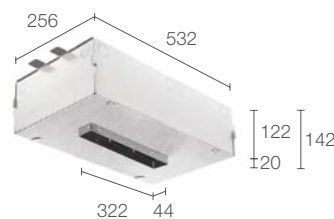

WC8709

Outer casing for rebated installation in solid ceilings (Bitpop 8.1)



INDOOR RECESSED DOWNLIGHTS SHOWCASES AND NICHE IN MUSEUMS AND RETAIL SPACES

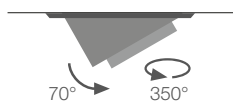

2700K 3000K 4000K

Ø55 mm

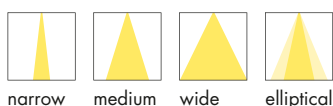

narrow medium wide elliptical

**WITH ANTI-GLARE
SNOOT**



CIAK 1.0 p. 542
max 1.5W max 500mA
constant current



CIAK 1.6 p. 543
2.5W 24Vdc
constant voltage

**WITHOUT ANTI-GLARE
SNOOT**



CIAK 1.1 p. 542
max 1.5W max 500mA
constant current



CIAK 1.7 p. 543
2.5W 24Vdc
constant voltage

Ø70 mm

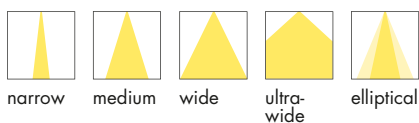

narrow medium wide ultra-wide elliptical



CIAK 2.6 p. 545
5W 24Vdc
constant voltage



CIAK 2.7 p. 545
5W 24Vdc
constant voltage



BUILT-IN PROTECTION SYSTEMS:
EPS
ELECTRICAL PROTECTION SYSTEM



CRI >90
THE ENTIRE CIAK FAMILY USES
LIGHT SOURCES WITH A
HIGH COLOUR RENDERING INDEX

BODY AND TRIM
IN ALUMINIUM,
MADE ENTIRELY
ON A CNC LATHE

- THE LIGHT BEAM CAN BE PRECISELY
DIRECTED THANKS TO THE HIGH
ADJUSTABILITY OF THE OPTICAL UNIT:
- ROTATABLE UP TO 350° ON VERTICAL AXIS
 - TILTABLE UP TO 70° ON HORIZONTAL AXIS

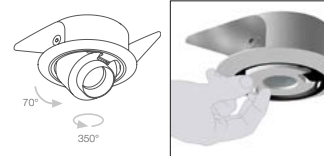

LOW THICKNESSES
CIAK'S COMPACT HEIGHT
– 22 MM (CIAK 1)
AND 30 MM (CIAK 2) –
MEANS IT CAN BE RECESSED
INTO SHALLOW SHELVES SUCH
AS THOSE IN SHOP WINDOWS
AND DISPLAY CABINETS AND
STILL RESPECT THE NECESSARY
HEAT-TRANSFER VOLUMES



UNIQUE SELLING POINTS



RAL FINISH
ON REQUEST



WHITE



BLACK

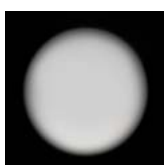

CIAK HAS SHARP OPTICS
TO PRODUCE A LIGHT BEAM
WITH PIN-SHARP EDGES



ALL VERSIONS ARE AVAILABLE
WITH OR WITHOUT AN
ANTI-GLARE SNOOT FOR
GREATER VISUAL COMFORT



< **CIAK 2.6**
3000K, 5W, 13°x43°, black

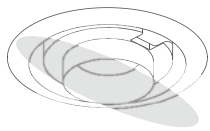

16°x34° optics
(Ciak 1.0 / 1.6)

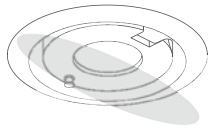

16°x34° optics
(Ciak 1.1 / 1.7)

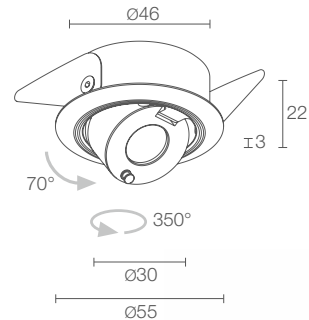
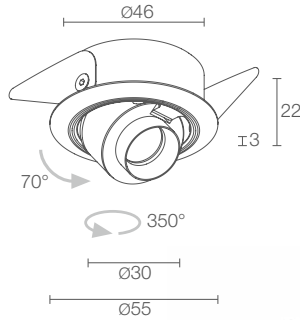

CIAK 1.0

Ø 50 mm

CE CB ENEC LED TECH III kg 0.11 IP40
A A+ A++ CASAMBI

POWER / POWER SUPPLY CODE

max 1.5W max 500mA
CK10101 B White
CK10101 N Black

LED COLOUR

F - 2700K
5 - 3000K
9 - 4000K

OPTICS

S - 17°
M - 29°
P - 48° sharp
L - 52°
W - 16°x34°

LUMEN OUTPUT AT SOURCE	157 lm (3000K, 500mA)
DELIVERED LUMEN OUTPUT	144 lm (3000K, 500mA, 29°)
NO. AND TYPE OF LED	1 power LED 1/4 ANSI BIN, 50000h L90 B10 (Ta 25°C)
MATERIAL	body and trim in aluminium
POWER SUPPLY UNIT	not included, see p. 904
POWER CABLES	includes 1.5 m PVC cable FROR 2x0.35 Ø3.5 mm
WIRING	series
MOUNTING	recessed (ceiling, shelf, shop windows)
FEATURES	CRI >90
PHOTOMETRIC DATA	see p. 808

CIAK 1.1

Ø 50 mm

CE CB ENEC LED TECH III kg 0.07 IP40
A A+ A++ CASAMBI

max 1.5W max 500mA
CK11101 B White
CK11101 N Black

F - 2700K
5 - 3000K
9 - 4000K

S - 17°
M - 29°
P - 48° sharp
L - 52°
W - 16°x34°

LUMEN OUTPUT AT SOURCE	157 lm (3000K, 500mA)
DELIVERED LUMEN OUTPUT	144 lm (3000K, 500mA, 29°)
NO. AND TYPE OF LED	1 power LED 1/4 ANSI BIN, 50000h L90 B10 (Ta 25°C)
MATERIAL	body and trim in aluminium
POWER SUPPLY UNIT	not included, see p. 904
POWER CABLES	includes 1.5 m PVC cable FROR 2x0.35 Ø3.5 mm
WIRING	series
MOUNTING	recessed (ceiling, shelf, shop windows)
FEATURES	CRI >90
PHOTOMETRIC DATA	see p. 808

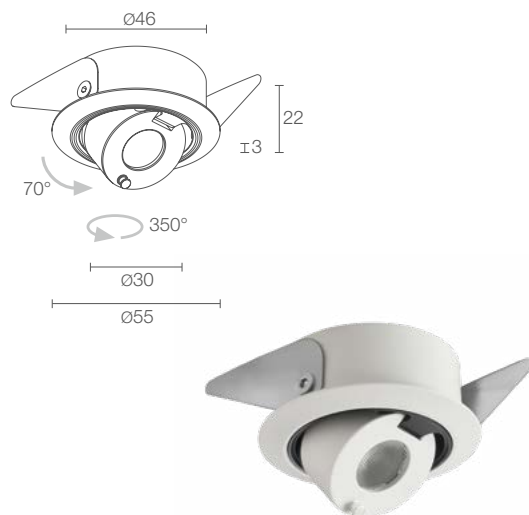

CIAK 1.6

Ø 50 mm

CE CB ENEC LED TECH III kg 0.11 IP40
 A A+ A++ EPS CASAMBI

2.5W 24Vdc

CK16001 B White
 CK16001 N Black

F - 2700K
 5 - 3000K
 9 - 4000K

S - 17°
 M - 29°
 P - 48° sharp
 L - 52°
 W - 16°x34°

157 lm (3000K)

144 lm (3000K, 29°)

1 power LED
 1/4 ANSI BIN, 50000h L90 B10 (Ta 25°C)

body and trim in aluminium

not included, see p. 904

includes 1.5 m PVC cable
 FROR 2x0.35/0.35 Ø3.5 mm

parallel

recessed (ceiling, shelf, shop windows)

CRI >90

see p. 808

CIAK 1.7

Ø 50 mm

CE CB ENEC LED TECH III kg 0.07 IP40
 A A+ A++ EPS CASAMBI

2.5W 24Vdc

CK17001 B White
 CK17001 N Black

F - 2700K
 5 - 3000K
 9 - 4000K

S - 17°
 M - 29°
 P - 48° sharp
 L - 52°
 W - 16°x34°

157 lm (3000K)

144 lm (3000K, 29°)

1 power LED
 1/4 ANSI BIN, 50000h L90 B10 (Ta 25°C)

body and trim in aluminium

not included, see p. 904

includes 1.5 m PVC cable
 FROR 2x0.35/0.35 Ø3.5 mm

parallel

recessed (ceiling, shelf, shop windows)

CRI >90

see p. 808





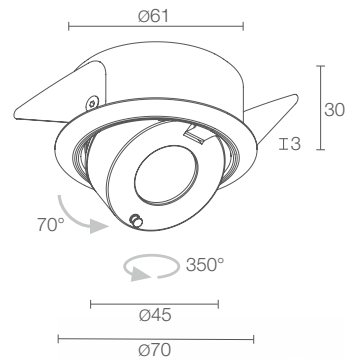
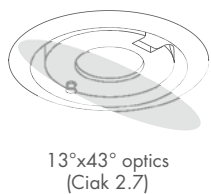
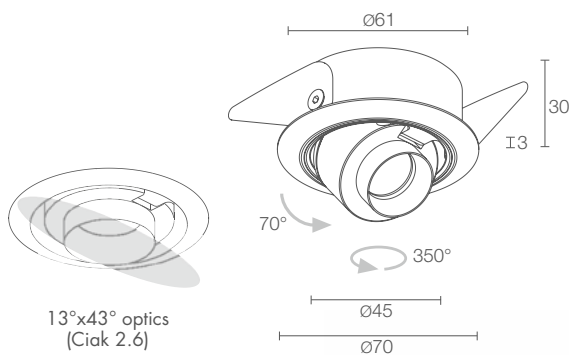

CIAK 2.6

Ø 65 mm

CE CB ENEC LED TECH III kg 0.15 IP40
A A+ A++ EPS CASAMBI

POWER / POWER SUPPLY CODE

5W 24Vdc
CK26001 ■ ■ B White
CK26001 ■ ■ N Black

LED COLOUR

F - 2700K
 5 - 3000K
 9 - 4000K

OPTICS

S - 11°
 M - 17°
 P - 19° sharp
 L - 32°
 J - 65°
 W - 13°x43°

LUMEN OUTPUT AT SOURCE	452 lm (3000K)
DELIVERED LUMEN OUTPUT	303 lm (3000K, 32°)
NO. AND TYPE OF LED	1 high-intensity power LED 3-step MacAdam, 50000h L95 B10 (Ta 25°C)
MATERIAL	body and trim in aluminium
POWER SUPPLY UNIT	not included, see p. 904
POWER CABLES	includes 1.5 m PVC cable FROR 2x0.35/0.35 Ø3.5 mm
MOUNTING	recessed (ceiling, shelf, shop windows)
FEATURES	CRI >90
PHOTOMETRIC DATA	see p. 808

CIAK 2.7

Ø 65 mm

CE CB ENEC LED TECH III kg 0.15 IP40
A A+ A++ EPS CASAMBI

5W 24Vdc
CK27001 ■ ■ B White
CK27001 ■ ■ N Black

F - 2700K
 5 - 3000K
 9 - 4000K

S - 11°
 M - 17°
 P - 19° sharp
 L - 32°
 J - 65°
 W - 13°x43°

LUMEN OUTPUT AT SOURCE	452 lm (3000K)
DELIVERED LUMEN OUTPUT	303 lm (3000K, 32°)
NO. AND TYPE OF LED	1 high-intensity power LED 3-step MacAdam, 50000h L95 B10 (Ta 25°C)
MATERIAL	body and trim in aluminium
POWER SUPPLY UNIT	not included, see p. 904
POWER CABLES	includes 1.5 m PVC cable FROR 2x0.35/0.35 Ø3.5 mm
MOUNTING	recessed (ceiling, shelf, shop windows)
FEATURES	CRI >90
PHOTOMETRIC DATA	see p. 808





INDOOR RECESSED DOWNLIGHTS FALSE CEILINGS AND NICHE IN PRIVATE HOMES



2700K 3000K 4000K

FIXED OPTICS AND FIXED FOCUS

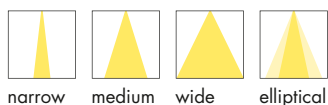

narrow medium wide elliptical

Ø39 mm



CAMEO 1.0 p. 548
max 1.5W max 500mA
constant current

CAMEO 1.6 p. 550
2.5W 24Vdc
constant voltage

Ø49 mm



CAMEO 2.6 p. 552
5W 24Vdc
constant voltage

TILTABLE OPTICS AND FIXED FOCUS

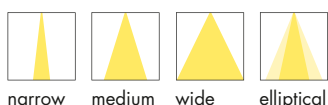

narrow medium wide elliptical

Ø58 mm



CAMEO 1.1 p. 549
max 1.5W max 500mA
constant current

CAMEO 1.7 p. 551
2.5W 24Vdc
constant voltage

Ø69 mm



CAMEO 2.7 p. 553
5W 24Vdc
constant voltage

TILTABLE ZOOM LENS

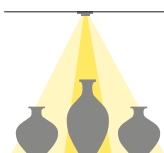

Ø58 mm



CAMEO 1.2 p. 549
max 1.5W max 500mA
constant current

CAMEO 1.8 p. 551
2.5W 24Vdc
constant voltage

Ø69 mm



CAMEO 2.8 p. 553
5W 24Vdc
constant voltage



^
CAMEO 1.1
 3000K, 1.5W, 29°, black

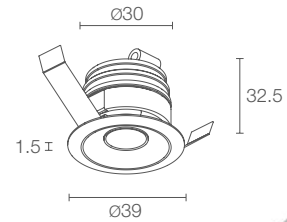

CAMEO 1.0

Ø 35 mm

CE CB ENEC LED TECH III kg 0.07 IP40
 A A+ A++ CASAMBI

POWER / POWER SUPPLY CODE max 1.5W max 500mA
CM10201000 **O** **E** White
CM10201000 **O** **N** Black

LED COLOUR **F** - 2700K
5 - 3000K
9 - 4000K

OPTICS **S** - 17°
M - 29°
P - 48° sharp
L - 52°
W - 16°x34°

LUMEN OUTPUT AT SOURCE	157 lm (3000K, 500mA)
DELIVERED LUMEN OUTPUT	144 lm (3000K, 500mA, 29°)
NO. AND TYPE OF LED	1 power LED, 1/4 ANSI BIN 50000h L90 B10 (T _a 25°C)
MATERIAL	body and trim in aluminium
POWER SUPPLY UNIT	not included, see p. 904
POWER CABLES	includes 1.5 m PVC cable FROR 2x0.35 Ø3.5 mm
WIRING	series
MOUNTING	recessed (ceilings, false ceilings, niches in plasterboard)
FEATURES	CRI >90
PHOTOMETRIC DATA	see p. 806



CAMEO 1.1 Ø 54 mm















max 1.5W max 500mA
CM11201000  **O E** White
CM11201000  **O N** Black

 **F** - 2700K
5 - 3000K
9 - 4000K

 **S** - 17° tiltable ±20°
M - 29° tiltable ±20°
P - 48° sharp tiltable ±20°
L - 52° tiltable ±20°
W - 16°x34° tiltable ±20°

157 lm (3000K, 500mA)

144 lm (3000K, 500mA, 29°)

1 power LED, 1/4 ANSI BIN
50000h L90 B10 (Ta 25°C)

body and trim in aluminium

not included, see p. 904

includes 1.5 m PVC cable
FROR 2x0.35 Ø3.5 mm

series

recessed (ceilings, false ceilings, niches in plasterboard)

CRI >90

see p. 806

CAMEO 1.2 Ø 54 mm













max 1.5W max 500mA
CM12201000  **R1 E** White
CM12201000  **R1 N** Black

 **F** - 2700K
5 - 3000K
9 - 4000K

optical range 8°-40° tiltable ±20°

157 lm (3000K, 500mA)

50 lm (3000K, 500mA, 40°)

1 power LED, 1/4 ANSI BIN
50000h L90 B10 (Ta 25°C)

body and trim in aluminium

not included, see p. 904

includes 1.5 m PVC cable
FROR 2x0.35 Ø3.5 mm

series

recessed (ceilings, false ceilings, niches in plasterboard)

CRI >90

see p. 806





^
CAMEO 1.8
 3000K, 2.5W, tiltable zoom lens 8°–40°, black

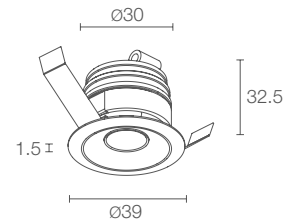

CAMEO 1.6

Ø 35 mm

CE CB EAC LED TECH III kg 0.07 IP40
 A A+ A++ EPS CASAMBI

POWER / POWER SUPPLY CODE

2.5W 24Vdc

CM16001000 0 E White

CM16001000 0 N Black

LED COLOUR

F - 2700K

5 - 3000K

9 - 4000K

OPTICS

S - 17°

M - 29°

P - 48° sharp

L - 52°

W - 16°x34°

LUMEN OUTPUT AT SOURCE 157 lm (3000K)

DELIVERED LUMEN OUTPUT 144 lm (3000K, 29°)

NO. AND TYPE OF LED 1 power LED, 1/4 ANSI BIN
 50000h L90 B10 (T_a 25°C)

MATERIAL body and trim in aluminium

POWER SUPPLY UNIT not included, see p. 904

POWER CABLES includes 1.5 m PVC cable
 FROR 2x0.35/0.35 Ø3.5 mm

MOUNTING recessed (ceilings, false ceilings, niches in plasterboard)

FEATURES CRI >90

PHOTOMETRIC DATA see p. 806

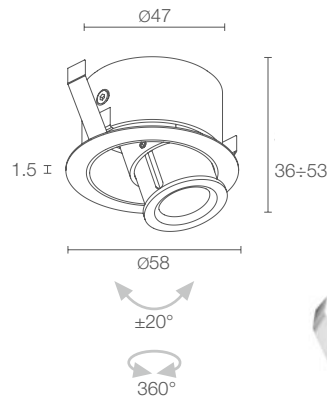
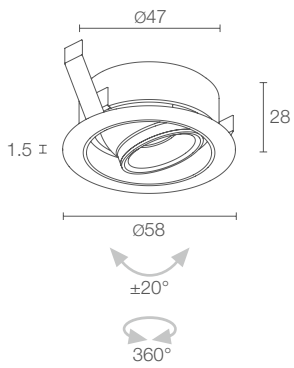

CAMEO 1.7



CE CB ENEC LED TECH III kg 0.07 IP40
 A A+ A++ EPS CASAMBI

2.5W 24Vdc

CM17001000 **O** **E** White
 CM17001000 **O** **N** Black

F - 2700K
5 - 3000K
9 - 4000K

S - 17° tiltable ±20°
M - 29° tiltable ±20°
P - 48° sharp tiltable ±20°
L - 52° tiltable ±20°
W - 16°x34° tiltable ±20°

157 lm (3000K)

144 lm (3000K, 29°)

1 power LED, 1/4 ANSI BIN
 50000h L90 B10 (Ta 25°C)

body and trim in aluminium

not included, see p. 904

includes 1.5 m PVC cable
 FROR 2x0.35/0.35 Ø3.5 mm

recessed (ceilings, false ceilings, niches in plasterboard)

CRI >90

see p. 806

CAMEO 1.8



CE CB ENEC LED TECH III kg 0.07 IP40
 A A+ A++ EPS CASAMBI

2.5W 24Vdc

CM18001000 **R1 E** White
 CM18001000 **R1 N** Black

F - 2700K
5 - 3000K
9 - 4000K

optical range 8°-40° tiltable ±20°

157 lm (3000K)

50 lm (3000K, 40°)

1 power LED, 1/4 ANSI BIN
 50000h L90 B10 (Ta 25°C)

body and trim in aluminium

not included, see p. 904

includes 1.5 m PVC cable
 FROR 2x0.35/0.35 Ø3.5 mm

recessed (ceilings, false ceilings, niches in plasterboard)

CRI >90

see p. 806





^
CAMEO 2.6
 3000K, 5W, 17°, black

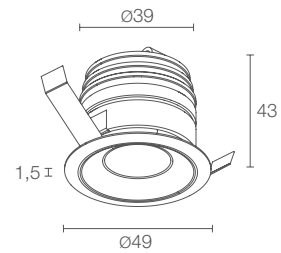

CAMEO 2.6

Ø 45 mm

CE CB ENEC LED TECH kg 0.15 IP40

A A+ A++ CASAMBI

POWER / POWER SUPPLY CODE 5W 24Vdc
CM26001000 **0** **E** White
CM26001000 **0** **N** Black

LED COLOUR	F - 2700K 5 - 3000K 9 - 4000K
OPTICS	S - 11° M - 17° P - 19° sharp L - 32° J - 65° W - 13°x43°

LUMEN OUTPUT AT SOURCE	452 lm (3000K)
DELIVERED LUMEN OUTPUT	303 lm (3000K, 32°)
NO. AND TYPE OF LED	1 high-intensity power LED, 3-step MacAdam 50000h L95 B10 (T _a 25°C)
MATERIAL	body and trim in aluminium
POWER SUPPLY UNIT	not included, see p. 904
POWER CABLES	includes 1.5 m PVC cable FROR 2x0.35/0.35 Ø3.5 mm
MOUNTING	recessed (ceilings, false ceilings, niches in plasterboard)
FEATURES	CRI >90
PHOTOMETRIC DATA	see p. 807

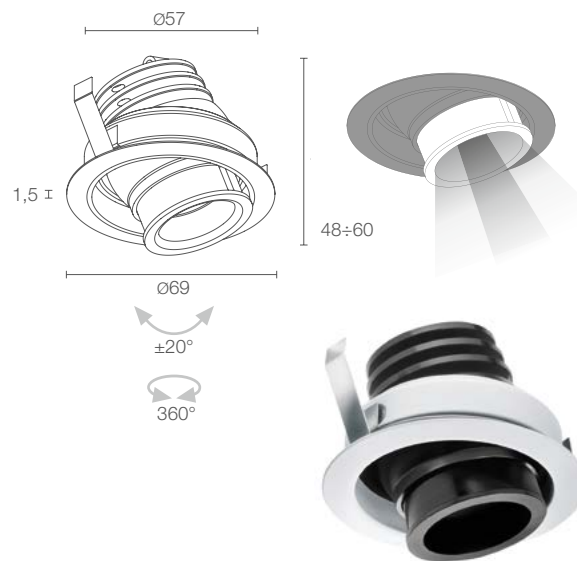

CAMEO 2.7

CAMEO 2.8







CE CB ENEC LED TECH  kg 0.15 IP40

A A+ A++  CASAMBI

5W 24Vdc

CM27001000  O  E White
CM27001000  O  N Black

 F - 2700K
 5 - 3000K
 9 - 4000K

 S - 11° tiltable ±20°
 M - 17° tiltable ±20°
 P - 19° sharp tiltable ±20°
 L - 32° tiltable ±20°
 J - 65° tiltable ±20°
 W - 13°x43° tiltable ±20°

CE CB ENEC LED TECH  kg 0.15 IP40

A A+ A++  CASAMBI

5W 24Vdc

CM28001000  R1  E White
CM28001000  R1  N Black

 F - 2700K
 5 - 3000K
 9 - 4000K

optical range 8°–58° tiltable ±20°

452 lm (3000K)

303 lm (3000K, 32°)

1 high-intensity power LED, 3-step MacAdam
50000h L95 B10 (Ta 25°C)

body and trim in aluminium

not included, see p. 904

includes 1.5 m PVC cable
FROR 2x0.35/0.35 Ø3.5 mm

recessed (ceilings, false ceilings, niches in plasterboard)

CRI >90

see p. 807

452 lm (3000K)

241 lm (3000K, 58°)

1 high-intensity power LED, 3-step MacAdam
50000h L95 B10 (Ta 25°C)

body and trim in aluminium

not included, see p. 904

includes 1.5 m PVC cable
FROR 2x0.35/0.35 Ø3.5 mm

recessed (ceilings, false ceilings, niches in plasterboard)

CRI >90

see p. 807





^
ESEM 3.2
 3000K, 8W, black

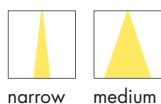
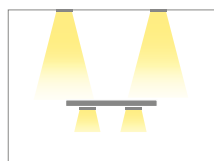

narrow medium

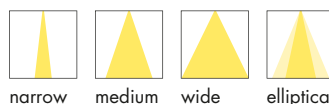
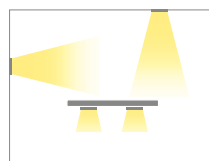

narrow medium wide elliptical

FIXED OPTICS

Ø31 mm



ESEM MINI 1.0 p. 556
 max 2W max 500mA
 constant current

ESEM MINI 1.6 p. 557
 2W 24Vdc
 constant voltage

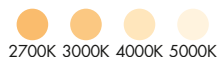

2700K 3000K 4000K 5000K

Ø46 mm



ESEM MID 1.0 p. 558
 max 3W max 350mA
 constant current

ESEM MID 1.6 p. 559
 3W 24Vdc
 constant voltage



2700K 3000K 4000K 5000K

TILTABLE OPTICS

Ø40 mm



ESEM MINI 1.1 p. 556
 max 2W max 500mA
 constant current

ESEM MINI 1.7 p. 557
 2W 24Vdc
 constant voltage

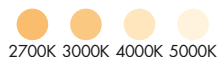

2700K 3000K 4000K 5000K

Ø55 mm



ESEM MID 1.1 p. 558
 max 3W max 350mA
 constant current

ESEM MID 1.7 p. 559
 3W 24Vdc
 constant voltage



2700K 3000K 4000K 5000K

INDOOR RECESSED DOWNLIGHTS SHOWCASES AND FALSE CEILINGS IN HOSPITALITY AND PRIVATE HOMES

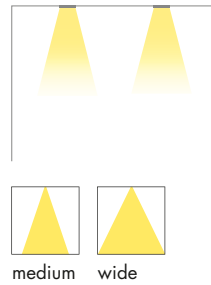
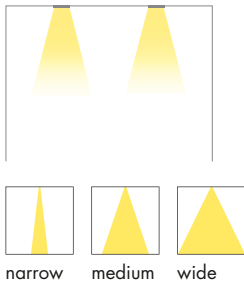

Ø38 mm

Ø59 mm

Ø75 mm



ESEM 2.0 p. 561
max 2W max 500mA
constant current

ESEM 3.0 p. 562
8W 230Vac
ON/OFF, DALI
mains voltage

ESEM 4.0 p. 564
14W 230Vac
ON/OFF, DALI,
0/1-10V, mains dimming
mains voltage

ESEM 2.6 p. 561
2W 24Vdc
constant voltage



Ø74 mm

Ø74 mm

Ø89 mm

Ø89 mm



ESEM 3.1 p. 563
8W 230Vac
ON/OFF, DALI,
0/1-10V
mains voltage

ESEM 3.2 p. 563
8W 230Vac
ON/OFF, DALI,
0/1-10V
mains voltage

ESEM 4.1 p. 565
14W 230Vac
ON/OFF, DALI,
0/1-10V, mains dimming
mains voltage

ESEM 4.2 p. 565
14W 230Vac
ON/OFF, DALI,
0/1-10V, mains dimming
mains voltage



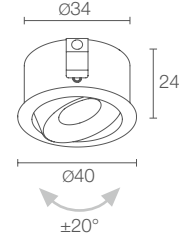
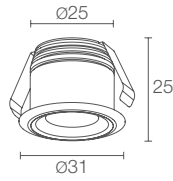

ESEM MINI 1.0



POWER / POWER SUPPLY CODE

max 2W max 500mA
ME1012 ■ ■ **B** White
ME1012 ■ ■ **N** Black
ME1012 ■ ■ **A** Anodized grey

LED COLOUR

F - 2700K
5 - 3000K
9 - 4000K
0 - 5000K

OPTICS

S - 14°
M - 27°

LUMEN OUTPUT AT SOURCE	145 lm (3000K, 500mA)
DELIVERED LUMEN OUTPUT	125 lm (3000K, 500mA, 27°)
NO. AND TYPE OF LED	1 power LED 1/4 ANSI BIN, 50000h L90 B10 (Ta 25°C)
MATERIAL	body in aluminium
POWER SUPPLY UNIT	not included, see p. 904
POWER CABLES	includes 2x0.50 m single-core cables
WIRING	series
MOUNTING	recessed (ceiling, shelf)
NOTES	certified ETL version available on request
PHOTOMETRIC DATA	see p. 826

ESEM MINI 1.1



max 2W max 500mA
ME1112 ■ ■ **B** White
ME1112 ■ ■ **N** Black
ME1112 ■ ■ **A** Anodized grey

F - 2700K
5 - 3000K
9 - 4000K
0 - 5000K

S - 14° tiltable ±20°
M - 27° tiltable ±20°

LUMEN OUTPUT AT SOURCE	145 lm (3000K, 500mA)
DELIVERED LUMEN OUTPUT	125 lm (3000K, 500mA, 27°)
NO. AND TYPE OF LED	1 power LED 1/4 ANSI BIN, 50000h L90 B10 (Ta 25°C)
MATERIAL	body in aluminium
POWER SUPPLY UNIT	not included, see p. 904
POWER CABLES	includes 2x0.50 m single-core cables
WIRING	series
MOUNTING	recessed (ceiling, shelf)
NOTES	certified ETL version available on request
PHOTOMETRIC DATA	see p. 826



ESEM MINI 1.6

Ø 90 mm
H 60 mm
Ø 27 mm

CE CB ENEC LED TECH III kg 0.045 IP20
A A+ A++ CASAMBI

2W 24Vdc

ME1600 ■ **B** White
ME1600 ■ **N** Black
ME1600 ■ **A** Anodized grey

■ **F** - 2700K
5 - 3000K
9 - 4000K
0 - 5000K

■ **S** - 14°
M - 27°

145 lm (3000K)

125 lm (3000K, 27°)

1 power LED
1/4 ANSI BIN, 50000h L90 B10 (Ta 25°C)

body in aluminium

not included, see p. 904

includes 1.5 m PVC cable
FROR 2x0.35/0.35 Ø3.5 mm

parallel

recessed (ceiling, shelf)

certified ETL version available on request

see p. 826



ESEM MINI 1.7

Ø 90 mm
H 60 mm
Ø 35 mm

CE CB ENEC LED TECH III kg 0.07 IP20
A A+ A++ CASAMBI

2W 24Vdc

ME1700 ■ **B** White
ME1700 ■ **N** Black
ME1700 ■ **A** Anodized grey

■ **F** - 2700K
5 - 3000K
9 - 4000K
0 - 5000K

■ **S** - 14° tiltable ±20°
M - 27° tiltable ±20°

145 lm (3000K)

125 lm (3000K, 27°)

1 power LED
1/4 ANSI BIN, 50000h L90 B10 (Ta 25°C)

body in aluminium

not included, see p. 904

includes 1.5 m PVC cable
FROR 2x0.35/0.35 Ø3.5 mm

parallel

recessed (ceiling, shelf)

certified ETL version available on request

see p. 826

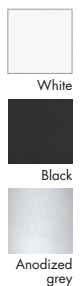

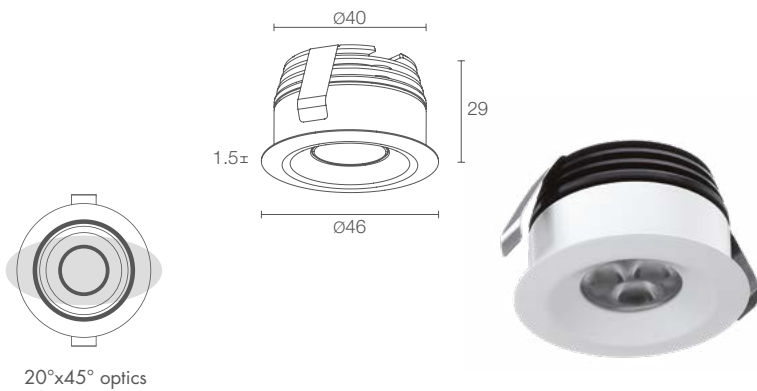

20°x45° optics



ESEM MID 1.0



POWER / POWER SUPPLY CODE

max 3W max 350mA
EM1031 ■ ■ **B** White
EM1031 ■ ■ **N** Black
EM1031 ■ ■ **A** Anodized grey

LED COLOUR

F - 2700K
5 - 3000K
9 - 4000K
0 - 5000K

OPTICS

S - 11°
M - 22°
L - 30°
W - 20°x45°

LUMEN OUTPUT AT SOURCE	309 lm (3000K, 350mA)
DELIVERED LUMEN OUTPUT	220 lm (3000K, 350mA, 22°)
NO. AND TYPE OF LED	3 power LEDs 1/4 ANSI BIN, 50000h L95 B10 (Ta 25°C)
MATERIAL	body and trim in aluminium
POWER SUPPLY UNIT	not included, see p. 904
POWER CABLES	includes 1.5 m PVC cable FROR 2x0.35 Ø3.5 mm
WIRING	series
MOUNTING	recessed (ceiling, wall, shelf)
NOTES	IP44 version available on request
PHOTOMETRIC DATA	see p. 826

ESEM MID 1.1



max 3W max 350mA
EM1131 ■ ■ **B** White
EM1131 ■ ■ **N** Black
EM1131 ■ ■ **A** Anodized grey

F - 2700K
5 - 3000K
9 - 4000K
0 - 5000K

S - 11° tiltable ±20°
M - 22° tiltable ±20°
L - 30° tiltable ±20°
W - 20°x45° tiltable ±20°

LUMEN OUTPUT AT SOURCE	309 lm (3000K, 350mA)
DELIVERED LUMEN OUTPUT	220 lm (3000K, 350mA, 22°)
NO. AND TYPE OF LED	3 power LEDs 1/4 ANSI BIN, 50000h L95 B10 (Ta 25°C)
MATERIAL	body and trim in aluminium
POWER SUPPLY UNIT	not included, see p. 904
POWER CABLES	includes 1.5 m PVC cable FROR 2x0.35 Ø3.5 mm
WIRING	series
MOUNTING	recessed (ceiling, wall, shelf)
NOTES	IP44 version available on request
PHOTOMETRIC DATA	see p. 826



ESEM MID 1.6

Ø 90 mm
H 80 mm

Ø 41 mm

CE CB ENEC LED TECH III kg 0.09 IP40
A A+ A++ CASAMBI

3W 24Vdc

EM1600 ■ ■ **B** White

EM1600 ■ ■ **N** Black

EM1600 ■ ■ **A** Anodized grey

■ **F** - 2700K
5 - 3000K
9 - 4000K
0 - 5000K

■ **S** - 11°
M - 22°
L - 30°
W - 20°x45°

309 lm (3000K)

220 lm (3000K, 22°)

3 power LEDs
1/4 ANSI BIN, 50000h L95 B10 (Ta 25°C)

body and trim in aluminium

not included, see p. 904

includes 1.5 m PVC cable
FROR 2x0.35/0.35 Ø3.5 mm

parallel

recessed (ceiling, wall, shelf)

IP44 version available on request

see p. 826

ESEM MID 1.7

Ø 90 mm
H 80 mm

Ø 50 mm

CE CB ENEC LED TECH III kg 0.09 IP40
A A+ A++ CASAMBI

3W 24Vdc

EM1700 ■ ■ **B** White

EM1700 ■ ■ **N** Black

EM1700 ■ ■ **A** Anodized grey

■ **F** - 2700K
5 - 3000K
9 - 4000K
0 - 5000K

■ **S** - 11° tiltable ±20°
M - 22° tiltable ±20°
L - 30° tiltable ±20°
W - 20°x45° tiltable ±20°

309 lm (3000K)

220 lm (3000K, 22°)

3 power LEDs
1/4 ANSI BIN, 50000h L95 B10 (Ta 25°C)

body and trim in aluminium

not included, see p. 904

includes 1.5 m PVC cable
FROR 2x0.35/0.35 Ø3.5 mm

parallel

recessed (ceiling, wall, shelf)

IP44 version available on request

see p. 826

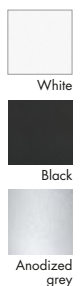

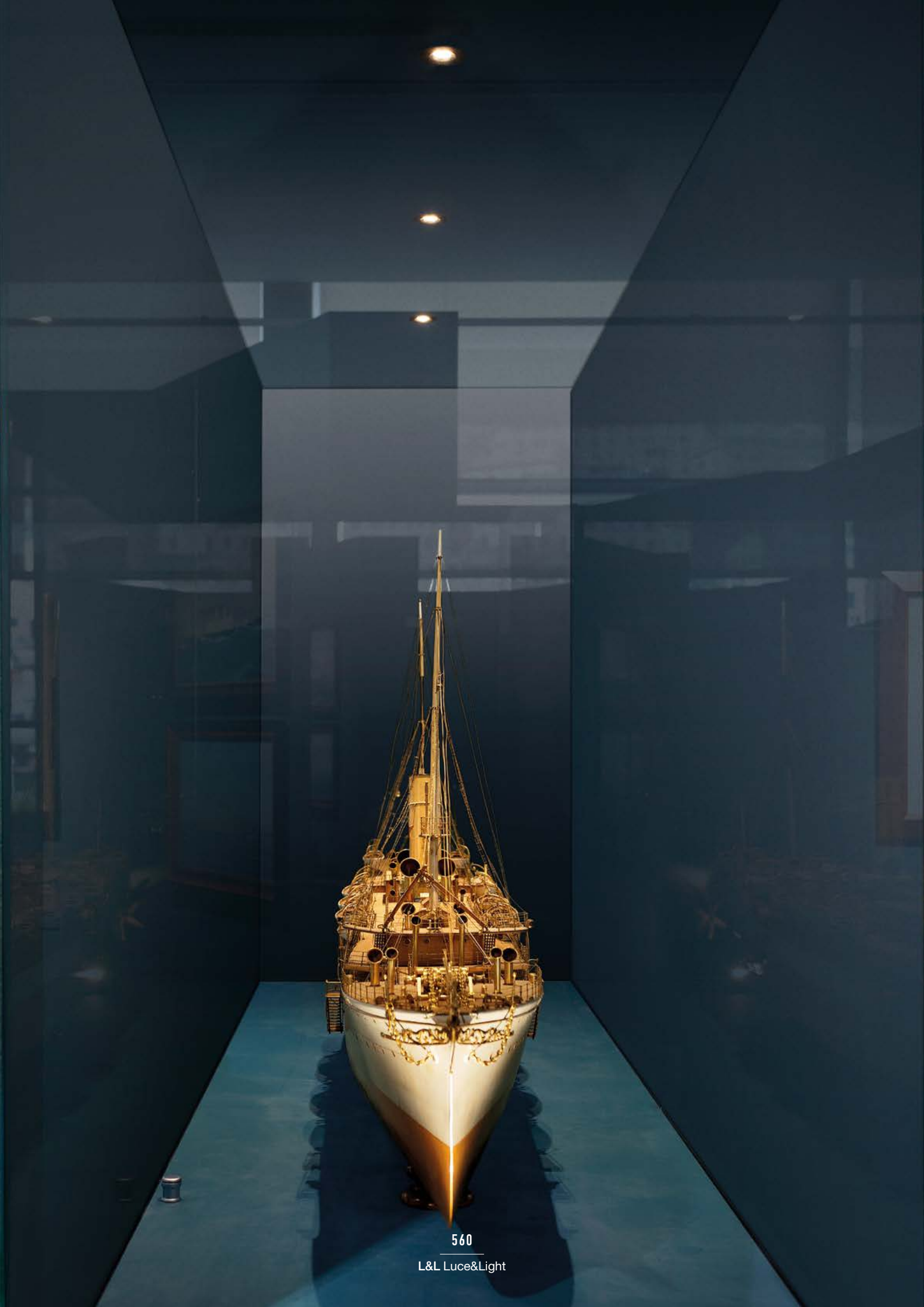

560

L&L Luce&Light



ESEM 2.0

Ø 130 mm
H 90 mm

Ø 30 mm

CE CB ENEC LED TECH III kg 0.09 IP40

A A+ A++ EPS CASAMBI

POWER / POWER SUPPLY CODE

max 2W max 500mA
ES2012 ■ ■ E B White

LED COLOUR

F - 2700K
5 - 3000K
9 - 4000K
0 - 5000K

OPTICS

S - 16°
M - 36°
L - 80°

LUMEN OUTPUT AT SOURCE	145 lm (3000K, 500mA)
DELIVERED LUMEN OUTPUT	122 lm (3000K, 500mA, 36°)
NO. AND TYPE OF LED	1 power LED 1/4 ANSI BIN, 50000h L90 B10 (Ta 25°C)
MATERIAL	body in aluminium
POWER SUPPLY UNIT	not included, see p. 904
POWER CABLES	includes 1.5 m PVC cable FROR 2x0.35 Ø3.5 mm
WIRING	series
MOUNTING	recessed (ceiling)
ACCESSORIES	WFO110 PVC cable FROR 2x0.35 Ø3.5 mm your choice of length order together with the lighting fixture
PHOTOMETRIC DATA	see p. 826

ESEM 2.6

Ø 130 mm
H 90 mm

Ø 30 mm

CE CB ENEC LED TECH III kg 0.09 IP40

A A+ A++ EPS CASAMBI

2W 24Vdc

ES2600 ■ ■ B White

F - 2700K
5 - 3000K
9 - 4000K
0 - 5000K

S - 16°
M - 36°
L - 80°

LUMEN OUTPUT AT SOURCE	145 lm (3000K)
DELIVERED LUMEN OUTPUT	122 lm (3000K, 36°)
NO. AND TYPE OF LED	1 power LED 1/4 ANSI BIN, 50000h L90 B10 (Ta 25°C)
MATERIAL	body in aluminium
POWER SUPPLY UNIT	not included, see p. 904
POWER CABLES	includes 1.5 m PVC cable FROR 2x0.35 Ø3.5 mm
WIRING	parallel
MOUNTING	recessed (ceiling)
ACCESSORIES	none
PHOTOMETRIC DATA	see p. 826



White

< ESEM MID 1.1

3000K, 3W, 30°, black

Project by / Studio ARCHH Lorenzo Agnese,
Giovanni Guerrieri

Photo by / Alessio Tamborini
The Coeclerici Gallery - Galata Maritime Museum,
Genoa, Italy

✓
ESEM 3.1
 3000K, 8W, 20°, white

Interior design by / Cristian Turra
 Photo by / Alessio Tamborini
 Private residence, Brescia, Italy



ESEM 3.0

Ø 170 mm H 150 mm Ø 50 mm

CE ENEC LED TECH DALI kg 0.25 IP40
 A A+ A++ DALI PUSH

POWER / POWER SUPPLY CODE

8W 230Vac
ES3010 ■ ■ **B** White
ES3010 ■ ■ **N** Black

8W 230Vac DALI + PUSH
ES3010 ■ ■ **BD** White
ES3010 ■ ■ **ND** Black

LED COLOUR

F - 2700K
5 - 3000K
9 - 4000K

OPTICS

S - 20°
M - 30°
L - 54°

LUMEN OUTPUT AT SOURCE	512 lm (3000K)
DELIVERED LUMEN OUTPUT	425 lm (3000K, 30°)
NO. AND TYPE OF LED	1 multichip power LED 2-step MacAdam, 50000h L90 B10 (Ta 25°C)
MATERIAL	body and trim in aluminium
POWER SUPPLY UNIT	included and wired
POWER CABLES	includes 0.30 m cable
MOUNTING	recessed (ceiling)
NOTES	available on request: Casambi-compatible version, controllable with the Casambi app, and version certified ETL
PHOTOMETRIC DATA	see p. 827



ESEM 3.1

Ø 180 mm
H 150 mm

Ø 65 mm

CE EAC LED TECH DALI kg 0.30 IP40
A A+ A++ DALI PUSH 0/1-10V

8W 230Vac
ES3100 ■ ■ B White
ES3100 ■ ■ N Black

8W 230Vac 0/1-10V + PUSH
ES3100 ■ ■ BR White
ES3100 ■ ■ NR Black

8W 230Vac DALI + PUSH
ES3100 ■ ■ BD White
ES3100 ■ ■ ND Black

■ F - 2700K
■ 5 - 3000K
■ 9 - 4000K

■ S - 20° tiltable ±25°
■ M - 30° tiltable ±25°
■ L - 54° tiltable ±25°

512 lm (3000K)

425 lm (3000K, 30°)

1 multichip power LED
2-step MacAdam, 50000h L90 B10 (Ta 25°C)

body and trim in aluminium

included and wired

includes 0.30 m cable

recessed (ceiling)

available on request: Casambi-compatible
version, controllable with the Casambi app,
and version certified ETL

see p. 827

ESEM 3.2

Ø 180 mm
H 150 mm

Ø 65 mm

CE EAC LED TECH DALI kg 0.30 IP40
A A+ A++ DALI PUSH 0/1-10V

8W 230Vac
ES3200 ■ ■ B White
ES3200 ■ ■ N Black

8W 230Vac 0/1-10V + PUSH
ES3200 ■ ■ BR White
ES3200 ■ ■ NR Black

8W 230Vac DALI + PUSH
ES3200 ■ ■ BD White
ES3200 ■ ■ ND Black

■ F - 2700K
■ 5 - 3000K
■ 9 - 4000K

■ S - 16° tiltable ±25°
■ M - 29° tiltable ±25°
■ L - 46° tiltable ±25°

512 lm (3000K)

436 lm (3000K, 29°)

1 multichip power LED
2-step MacAdam, 50000h L90 B10 (Ta 25°C)

body and trim in aluminium

included and wired

includes 0.30 m cable

recessed (ceiling)

available on request: Casambi-compatible
version, controllable with the Casambi app,
and version certified ETL

see p. 827



White

Black

✓
ESEM 4.2
 3000K, 14W, 24°, white

Interior design by / Cristian Turra
 Photo by / Alessio Tamborini
 Private residence, Brescia, Italy



ESEM 4.0

Ø 190 mm
 H 170 mm

Ø 65 mm

CE ENEC LED TECH
 kg 0.50 IP40
 A A+ A++ DALI PUSH 0/1-10V

POWER / POWER SUPPLY CODE

14W 230Vac
ES4010 ■ ■ **B** White
ES4010 ■ ■ **N** Black

14W 230Vac 0/1-10V + PUSH
ES4010 ■ ■ **BR** White
ES4010 ■ ■ **NR** Black

14W 230Vac DALI + PUSH
ES4010 ■ ■ **BD** White
ES4010 ■ ■ **ND** Black

14W 230Vac MAINS DIMMING
ES4010 ■ ■ **BT** White
ES4010 ■ ■ **NT** Black

■ LED COLOUR	F - 2700K 5 - 3000K 9 - 4000K
■ OPTICS	M - 20° L - 40°

LUMEN OUTPUT AT SOURCE	1219 lm (3000K)
DELIVERED LUMEN OUTPUT	957 lm (3000K, 20°)
NO. AND TYPE OF LED	1 multichip power LED 2-step MacAdam, 50000h L85 B10 (Ta 25°C)
MATERIAL	body and trim in aluminium
POWER SUPPLY UNIT	included and wired
POWER CABLES	includes 0.30 m cable
MOUNTING	recessed (ceiling)
NOTES	available on request: Casambi-compatible version, controllable with the Casambi app, and version certified ETL
PHOTOMETRIC DATA	see p. 827



ESEM 4.1

Ø 200 mm H 200 mm Ø 80 mm

CE EAC LED TECH IP40
A A+ A++ DALI PUSH 0/1-10V

14W 230Vac
ES4100 ■ ■ B White
ES4100 ■ ■ N Black

14W 230Vac 0/1-10V + PUSH
ES4100 ■ ■ BR White
ES4100 ■ ■ NR Black

14W 230Vac DALI + PUSH
ES4100 ■ ■ BD White
ES4100 ■ ■ ND Black

14W 230Vac MAINS DIMMING
ES4100 ■ ■ BT White
ES4100 ■ ■ NT Black

■ F - 2700K
 5 - 3000K
 9 - 4000K

■ M - 20° tilttable ±25°
 L - 40° tilttable ±25°

1219 lm (3000K)

957 lm (3000K, 20°)

1 multichip power LED
 2-step MacAdam, 50000h L85 B10 (Ta 25°C)

body and trim in aluminium

included and wired

includes 0.30 m cable

recessed (ceiling)

available on request: Casambi-compatible version, controllable with the Casambi app, and version certified ETL

see p. 827

ESEM 4.2

Ø 200 mm H 200 mm Ø 80 mm

CE EAC LED TECH IP40
A A+ A++ DALI PUSH 0/1-10V

14W 230Vac
ES4200 ■ ■ B White
ES4200 ■ ■ N Black

14W 230Vac 0/1-10V + PUSH
ES4200 ■ ■ BR White
ES4200 ■ ■ NR Black

14W 230Vac DALI + PUSH
ES4200 ■ ■ BD White
ES4200 ■ ■ ND Black

14W 230Vac MAINS DIMMING
ES4200 ■ ■ BT White
ES4200 ■ ■ NT Black

■ F - 2700K
 5 - 3000K
 9 - 4000K

■ M - 24° tilttable ±20°
 L - 37° tilttable ±20°

1219 lm (3000K)

940 lm (3000K, 24°)

1 multichip power LED
 2-step MacAdam, 50000h L85 B10 (Ta 25°C)

body and trim in aluminium

included and wired

includes 0.30 m cable

recessed (ceiling)









available on request: Casambi-compatible version, controllable with the Casambi app, and version certified ETL

see p. 827





INDOOR RECESSED DOWNLIGHTS STARRY SKY, SHELVES, SHOWCASES AND FALSE CEILINGS

	CONSTANT CURRENT	CONSTANT VOLTAGE
<p>IDEAL FOR STARRY SKY</p> <p>2700K 3000K 4000K 5000K blue</p> <p>wide diffuse</p>	<p>Ø25 mm</p>  <p>EYES 1.0 p. 568 max 1W max 350mA</p>	<p>Ø25 mm</p>  <p>EYES 1.6 p. 569 1W 24Vdc</p>
	<p>25x25 mm</p>  <p>EYES 1.2 p. 568 max 1W max 350mA</p>	<p>25x25 mm</p>  <p>EYES 1.8 p. 569 1W 24Vdc</p>
<p>IDEAL FOR SHELVES AND SHOWCASES</p> <p>2700K 3000K 4000K</p> <p>narrow medium elliptical diffuse</p>	<p>Ø34 mm</p>  <p>EYES 2.R p. 570 max 2.5W max 700mA</p>	<p>Ø34 mm</p>  <p>EYES 2.T p. 571 3W 24Vdc</p>
	<p>35x35 mm</p>  <p>EYES 2.S p. 570 max 2.5W max 700mA</p>	<p>35x35 mm</p>  <p>EYES 2.U p. 571 3W 24Vdc</p>

< EYES 2.R
4000K, 2.5W, 23°, white

Project and light planning by / Studio Casolaro
Giuseppe e Ottavio
Offices, Foggia, Italy

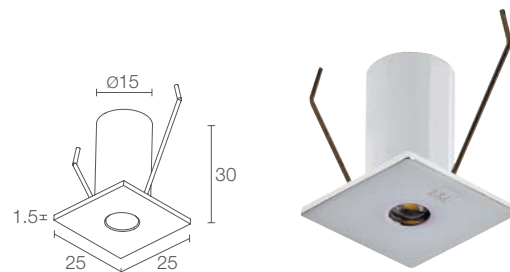
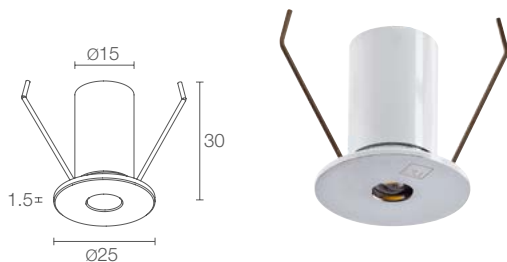

EYES 1.0



POWER / POWER SUPPLY CODE

max 1W max 350mA
EY1011 ■ ■ **B** White
EY1011 ■ ■ **C** Chrome
EY1011 ■ ■ **D** Gold
EY1011 ■ ■ **S** Satin
EY1011 ■ ■ **N** Black

LED COLOUR

F - 2700K
5 - 3000K
9 - 4000K
0 - 5000K
1 - blue

OPTICS

F - 40°
D - diffuse

LUMEN OUTPUT AT SOURCE	110 lm (3000K, 350mA)
DELIVERED LUMEN OUTPUT	54 lm (3000K, 350mA, 40°)
NO. AND TYPE OF LED	1 power LED 1/4 ANSI BIN (white LED colour) 50000h L90 B10 (Ta 25°C)
MATERIAL	body in anodized aluminium trim in brass
POWER SUPPLY UNIT	not included, see p. 904
POWER CABLES	includes 1.5 m PVC cable FROR 2x0.35 Ø3.5 mm
WIRING	series
MOUNTING	recessed (ceiling)
ACCESSORIES	see p. 573
PHOTOMETRIC DATA	see p. 828

EYES 1.2

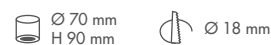

max 1W max 350mA
EY1211 ■ ■ **B** White
EY1211 ■ ■ **C** Chrome
EY1211 ■ ■ **D** Gold
EY1211 ■ ■ **S** Satin
EY1211 ■ ■ **N** Black

F - 2700K
5 - 3000K
9 - 4000K
0 - 5000K
1 - blue

F - 40°
D - diffuse

LUMEN OUTPUT AT SOURCE	110 lm (3000K, 350mA)
DELIVERED LUMEN OUTPUT	54 lm (3000K, 350mA, 40°)
NO. AND TYPE OF LED	1 power LED 1/4 ANSI BIN (white LED colour) 50000h L90 B10 (Ta 25°C)
MATERIAL	body in anodized aluminium trim in brass
POWER SUPPLY UNIT	not included, see p. 904
POWER CABLES	includes 1.5 m PVC cable FROR 2x0.35 Ø3.5 mm
WIRING	series
MOUNTING	recessed (ceiling)
ACCESSORIES	see p. 573
PHOTOMETRIC DATA	see p. 828

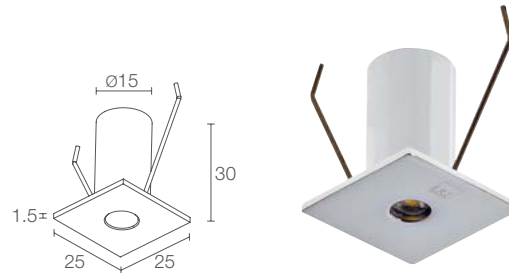
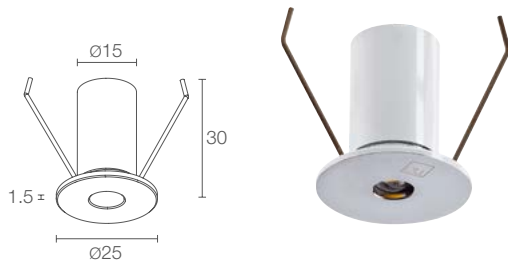

EYES 1.6

Ø 70 mm
H 90 mm

Ø 18 mm

CE EAC LED TECH III kg 0.08 IP40
A A+ A++ EPS CASAMBI

1W 24Vdc

EY1611 ■ ■ B White
EY1611 ■ ■ C Chrome
EY1611 ■ ■ D Gold
EY1611 ■ ■ S Satin
EY1611 ■ ■ N Black

■ F - 2700K
5 - 3000K
9 - 4000K
0 - 5000K
1 - blue

■ F - 40°
D - diffuse

110 lm (3000K)

54 lm (3000K, 40°)

1 power LED
1/4 ANSI BIN (white LED colour)
50000h L90 B10 (Ta 25°C)

body in anodized aluminium
trim in brass

not included, see p. 904

includes 1.5 m PVC cable
FROR 2x0.35 Ø3.5 mm

parallel

recessed (ceiling)

none

see p. 828

EYES 1.8

Ø 70 mm
H 90 mm

Ø 18 mm

CE EAC LED TECH III kg 0.08 IP40
A A+ A++ EPS CASAMBI

1W 24Vdc

EY1811 ■ ■ B White
EY1811 ■ ■ C Chrome
EY1811 ■ ■ D Gold
EY1811 ■ ■ S Satin
EY1811 ■ ■ N Black

■ F - 2700K
5 - 3000K
9 - 4000K
0 - 5000K
1 - blue

■ F - 40°
D - diffuse

110 lm (3000K)

54 lm (3000K, 40°)

1 power LED
1/4 ANSI BIN (white LED colour)
50000h L90 B10 (Ta 25°C)

body in anodized aluminium
trim in brass

not included, see p. 904

includes 1.5 m PVC cable
FROR 2x0.35 Ø3.5 mm

parallel

recessed (ceiling)

none

see p. 828



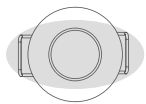

20°x40° optics
(Eyes 2.R / 2.T)



EYES 2.R

∅ 110 mm
H 90 mm

∅ 30 mm

CE LED TECH III kg 0.075 IP40
A A+ A++ EPS CASAMBI

POWER / POWER SUPPLY CODE

max 2.5W max 700mA
EY2R201000 O B White
EY2R201000 O S Satin
EY2R201000 O N Black

LED COLOUR

F - 2700K
5 - 3000K
9 - 4000K

OPTICS

S - 17°
M - 23°
L - 36°
W - 20°x40°
D - diffuse

LUMEN OUTPUT AT SOURCE	260 lm (3000K, 700mA)
DELIVERED LUMEN OUTPUT	160 lm (3000K, 700mA, 23°)
NO. AND TYPE OF LED	1 power LED 2-step MacAdam, 60000h L90 B10 (Ta 25°C)
MATERIAL	body in brass
POWER SUPPLY UNIT	not included, see p. 904
POWER CABLES	includes 1.5 m PVC cable FROR 2x0.35 ∅3.5 mm
WIRING	series
MOUNTING	recessed (ceiling)
ACCESSORIES	see p. 573
FEATURES	CRI >90
PHOTOMETRIC DATA	see p. 828

EYES 2.S

∅ 110 mm
H 90 mm

∅ 30 mm

CE LED TECH III kg 0.075 IP40
A A+ A++ EPS CASAMBI

max 2.5W max 700mA
EY2S201000 O B White
EY2S201000 O S Satin
EY2S201000 O N Black

F - 2700K
5 - 3000K
9 - 4000K

S - 17°
M - 23°
L - 36°
W - 20°x40°
D - diffuse

LUMEN OUTPUT AT SOURCE	260 lm (3000K, 700mA)
DELIVERED LUMEN OUTPUT	160 lm (3000K, 700mA, 23°)
NO. AND TYPE OF LED	1 power LED 2-step MacAdam, 60000h L90 B10 (Ta 25°C)
MATERIAL	body in brass
POWER SUPPLY UNIT	not included, see p. 904
POWER CABLES	includes 1.5 m PVC cable FROR 2x0.35 ∅3.5 mm
WIRING	series
MOUNTING	recessed (ceiling)
ACCESSORIES	see p. 573
FEATURES	CRI >90
PHOTOMETRIC DATA	see p. 828

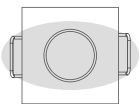
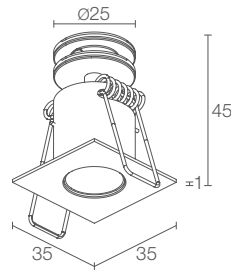
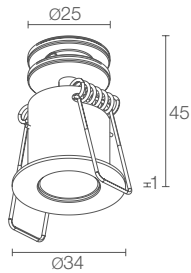

20°x40° optics
(Eyes 2.S / 2.U)



EYES 2.T

Ø 110 mm
H 90 mm
Ø 30 mm

CE LED TECH III kg 0.075 IP40
A A+ A++ EPS CASAMBI

3W 24Vdc

EY2T001000 ■ ■ ■ B White
EY2T001000 ■ ■ ■ S Satin
EY2T001000 ■ ■ ■ N Black

■ **F** - 2700K
5 - 3000K
9 - 4000K

■ **S** - 17°
M - 23°
L - 36°
W - 20°x40°
D - diffuse

260 lm (3000K)

160 lm (3000K, 23°)

1 power LED
2-step MacAdam, 60000h L90 B10 (Ta 25°C)

body in brass

not included, see p. 904

includes 1.5 m PVC cable
FROR 2x0.35 Ø3.5 mm

parallel

recessed (ceiling)

see p. 573

CRI >90

see p. 828

EYES 2.U

Ø 110 mm
H 90 mm
Ø 30 mm

CE LED TECH III kg 0.075 IP40
A A+ A++ EPS CASAMBI

3W 24Vdc

EY2U001000 ■ ■ ■ B White
EY2U001000 ■ ■ ■ S Satin
EY2U001000 ■ ■ ■ N Black

■ **F** - 2700K
5 - 3000K
9 - 4000K

■ **S** - 17°
M - 23°
L - 36°
W - 20°x40°
D - diffuse

260 lm (3000K)

160 lm (3000K, 23°)

1 power LED
2-step MacAdam, 60000h L90 B10 (Ta 25°C)

body in brass

not included, see p. 904

includes 1.5 m PVC cable
FROR 2x0.35 Ø3.5 mm

parallel

recessed (ceiling)

see p. 573

CRI >90

see p. 828





ACCESSORIES

ACCESSORIES
FOR INSTALLATION**WC0202**

Outer casing

(Eyes 2.R / 2.S / 2.T / 2.U)

POWER CABLES AND
CONTROL GEAR

Low-voltage converter with
350 mm cable to be used with
constant-voltage power supply unit
input: 24Vdc
output: 350mA constant, max 8.4W
dimnable with PWM
IP20

WFA024350

(Eyes 1.0 / 1.2 / 2.R / 2.S)



Low-voltage converter with
350 mm cable to be used with
constant-voltage power supply unit
input: 24Vdc
output: 500mA constant, max 12W
dimnable with PWM
IP20

WFA024500

(Eyes 2.R / 2.S)



Low-voltage converter with
350 mm cable to be used with
constant-voltage power supply unit
input: 24Vdc
output: 700mA constant, max 16.8W
dimnable with PWM
IP20

WFA024700

(Eyes 2.R / 2.S)

order together with the lighting fixture



INDOOR RECESSED DOWNLIGHTS FALSE CEILINGS IN RETAIL SPACES AND PRIVATE HOMES

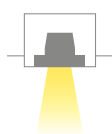

SINGLE BEAM

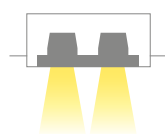

DOUBLE BEAM



3 BEAMS

2700K 3000K 4000K 5000K blue RGB



narrow medium wide



QUAD 6.1 p. 576
max 6W max 500mA



QUAD 6.2 p. 577
max 12W max 500mA



QUAD 6.3 p. 577
max 18W max 500mA

< **QUAD 6.3**
3000K, 18W, 24°, white

Interior design by / Cristian Turra
Private residence, Iseo, Brescia, Italy

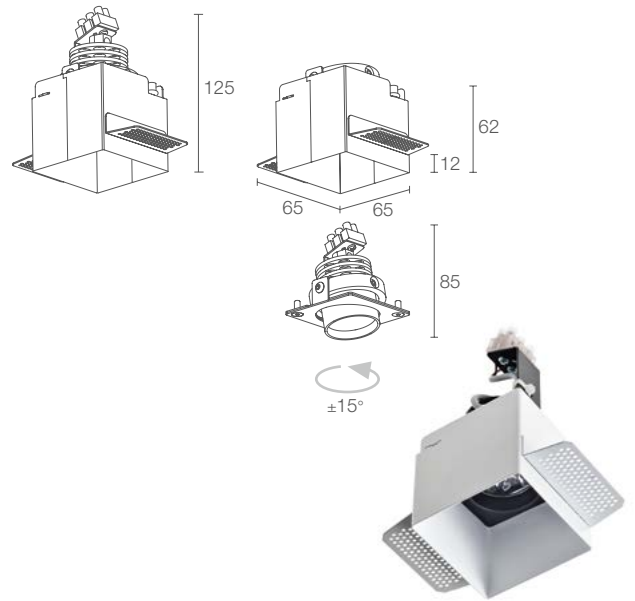

Required outer casing, not included

QUAD 6.1

165x165 mm
H 150 mm

65x65 mm

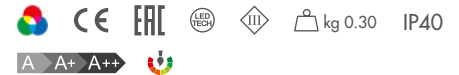

POWER / POWER SUPPLY CODE

max 6W max 500mA
QD6132 ■ **B** White
QD6132 ■ **N** Black

LED COLOUR

F - 2700K
5 - 3000K
9 - 4000K
0 - 5000K
1 - blue
6 - RGB

OPTICS

S - 12° tiltable ±15°
M - 24° tiltable ±15°
L - 56° tiltable ±15°

LUMEN OUTPUT AT SOURCE 436 lm (3000K, 500mA)
 RGB: 294 lm, R: 108 lm G: 140 lm
 B: 46 lm (500mA)

DELIVERED LUMEN OUTPUT 336 lm (3000K, 500mA, 24°)
 RGB: 210 lm, R: 77 lm G: 100 lm
 B: 33 lm (500mA, 24°)

NO. AND TYPE OF LED 3 power LEDs
 1/4 ANSI BIN (white LED colour)
 50000h L90 B10 (Ta 25°C)

MATERIAL body in anodized aluminium
 trim in steel

POWER SUPPLY UNIT not included, see p. 904 and 917

POWER CABLES terminal block

WIRING series

MOUNTING recessed (ceiling)

ACCESSORIES see p. 579

NOTES Casambi-compatible version, controllable with the Casambi app, available on request

PHOTOMETRIC DATA see p. 865

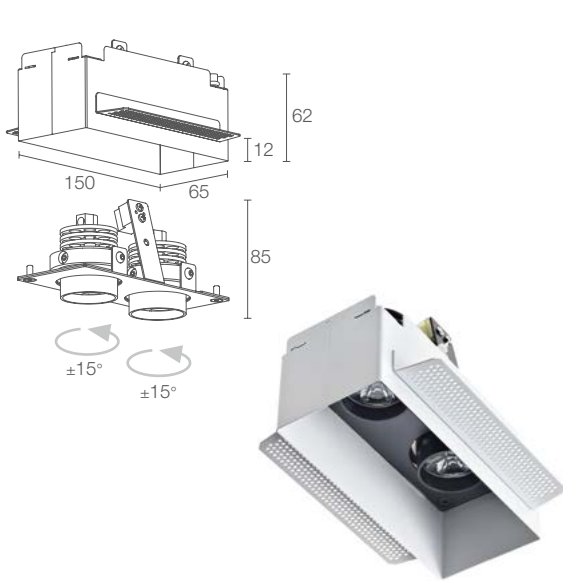

Required outer casing, not included

QUAD 6.2

165x250 mm
H 150 mm 65x150 mm

CE EAC LED TECH III kg 0.60 IP40

A A+ A++

max 12W max 500mA

QD6262 B White

QD6262 N Black

F - 2700K
5 - 3000K
9 - 4000K
0 - 5000K
1 - blue
6 - RGB

S - 12° tiltable ±15°
M - 24° tiltable ±15°
L - 56° tiltable ±15°

872 lm (3000K, 500mA)
RGB: 588 lm, R: 216 lm G: 280 lm
B: 92 lm (500mA)

672 lm (3000K, 500mA, 24°)
RGB: 420 lm, R: 154 lm G: 200 lm
B: 66 lm (500mA, 24°)

6 power LEDs
1/4 ANSI BIN (white LED colour)
50000h L90 B10 (Ta 25°C)

body in anodized aluminium
trim in steel

not included, see p. 904 and 917

terminal block

series

recessed (ceiling)

see p. 579

Casambi-compatible version, controllable with the
Casambi app, available on request

see p. 865

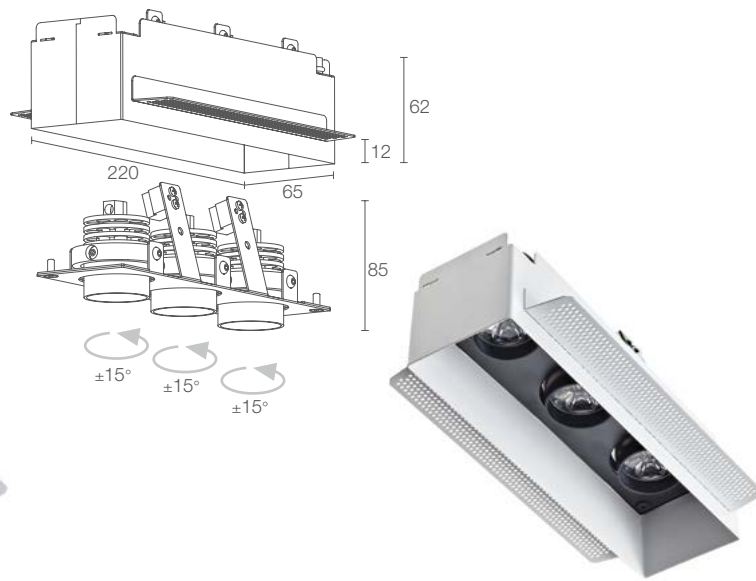

Required outer casing, not included

QUAD 6.3

165x325 mm
H 150 mm 65x220 mm

CE EAC LED TECH III kg 0.80 IP40

A A+ A++

max 18W max 500mA

QD6392 B White

QD6392 N Black

F - 2700K
5 - 3000K
9 - 4000K
0 - 5000K
1 - blue
6 - RGB

S - 12° tiltable ±15°
M - 24° tiltable ±15°
L - 56° tiltable ±15°

1308 lm (3000K, 500mA)
RGB: 882 lm, R: 324 lm G: 420 lm
B: 138 lm (500mA)

1008 lm (3000K, 500mA, 24°)
RGB: 630 lm, R: 231 lm G: 300 lm
B: 99 lm (500mA, 24°)

9 power LEDs
1/4 ANSI BIN (white LED colour)
50000h L90 B10 (Ta 25°C)

body in anodized aluminium
trim in steel

not included, see p. 904 and 917

terminal block

series

recessed (ceiling)

see p. 579

Casambi-compatible version, controllable with the
Casambi app, available on request

see p. 865



White



Black



ACCESSORIES

ACCESSORIES FOR INSTALLATION



WC2001
Outer casing for plasterboard
(Quad 6.1)

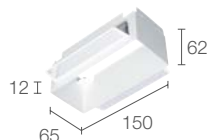

WC2002
Outer casing for plasterboard
(Quad 6.2)



WC2003
Outer casing for plasterboard
(Quad 6.3)



LED OPTICAL FIBRES

INDOOR RECESSED STARRY SKY

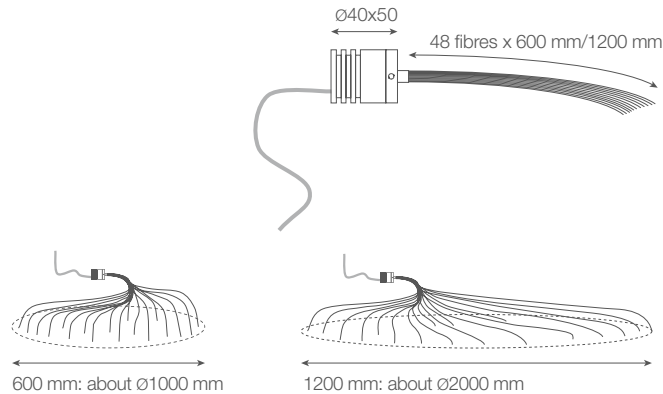

LED OPTICAL FIBRES

Ø 130 mm
H 90 mm

Ø 1 mm x 48



POWER / POWER SUPPLY CODE

max 3W max 700mA blue/white light 600 mm
FB1013 ■ **06EA**

max 3W max 700mA blue/white light 1200 mm
FB1013 ■ **12EA**

max 3W max 350mA RGB light 600 mm
FB1011 6 06A

max 3W max 350mA RGB light 1200 mm
FB1011 6 12A

LED COLOUR

F - 2700K
5 - 3000K
9 - 4000K
0 - 5000K
1 - blue

OPTICS

points of light

LUMEN OUTPUT AT SOURCE	186 lm (3000K, 700mA) RGB: 56 lm, R: 21 lm G: 26 lm B: 9 lm (350mA)
DELIVERED LUMEN OUTPUT	107 lm (3000K, 700mA) RGB: 40 lm, R: 15 lm G: 19 lm B: 6 lm (350mA)
NO. AND TYPE OF LED	1 power LED, 1/4 ANSI BIN (blue/white LED colour) RGB: 1 full-colour LED 50000h L90 B10 (Ta 25°C)
MATERIAL	anodized aluminium, optical fibres
POWER SUPPLY UNIT	not included, see p. 904 and 917
POWER CABLES	includes 1.5 m PVC cable FROR 2x0.50 Ø5.0 mm RGB: includes 1.5 m PVC cable FROR 6x0.25 Ø5.0 mm
WIRING	series
MOUNTING	recessed (ceiling, wall)
ACCESSORIES	WF0100 PVC cable FROR 2x0.50 Ø5.0 mm your choice of length (white LED colour) WF0210 PVC cable FROR 6x0.25 Ø5.0 mm your choice of length (RGB) order together with the lighting fixture
NOTES	available on request with optical fibres in non-standard lengths

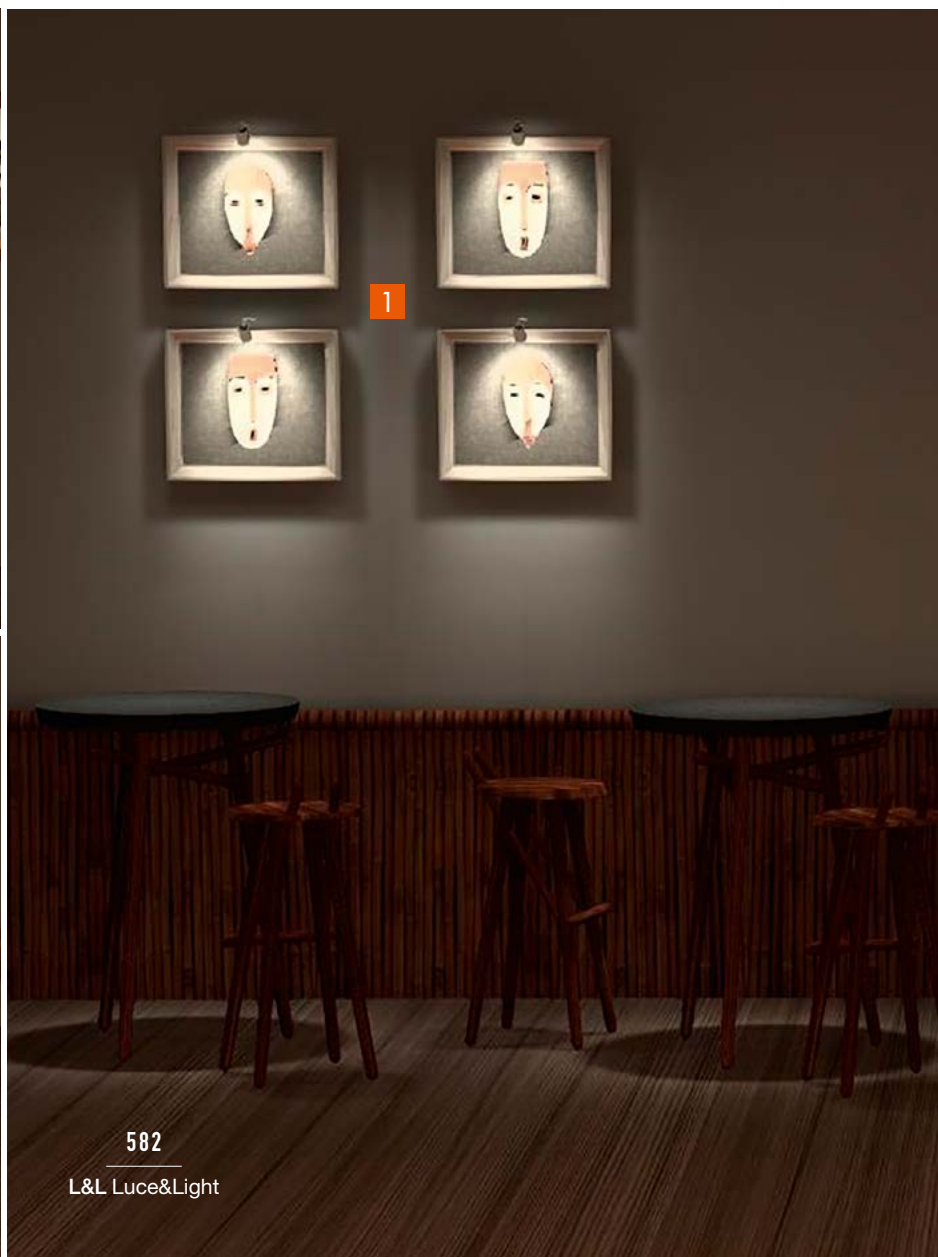
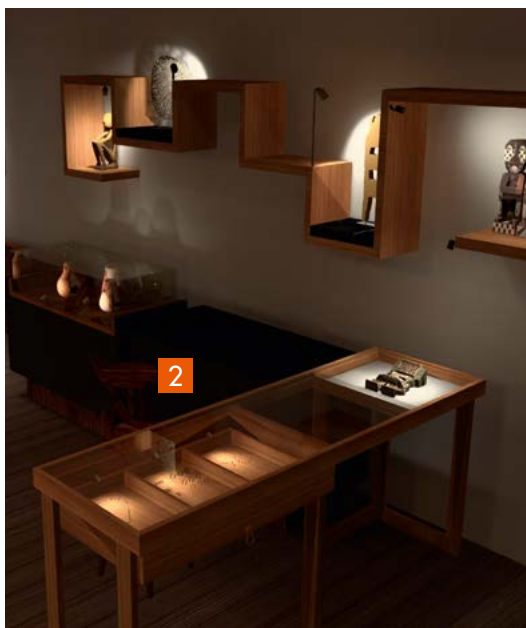



PROJECTORS FOR INDOOR APPLICATIONS



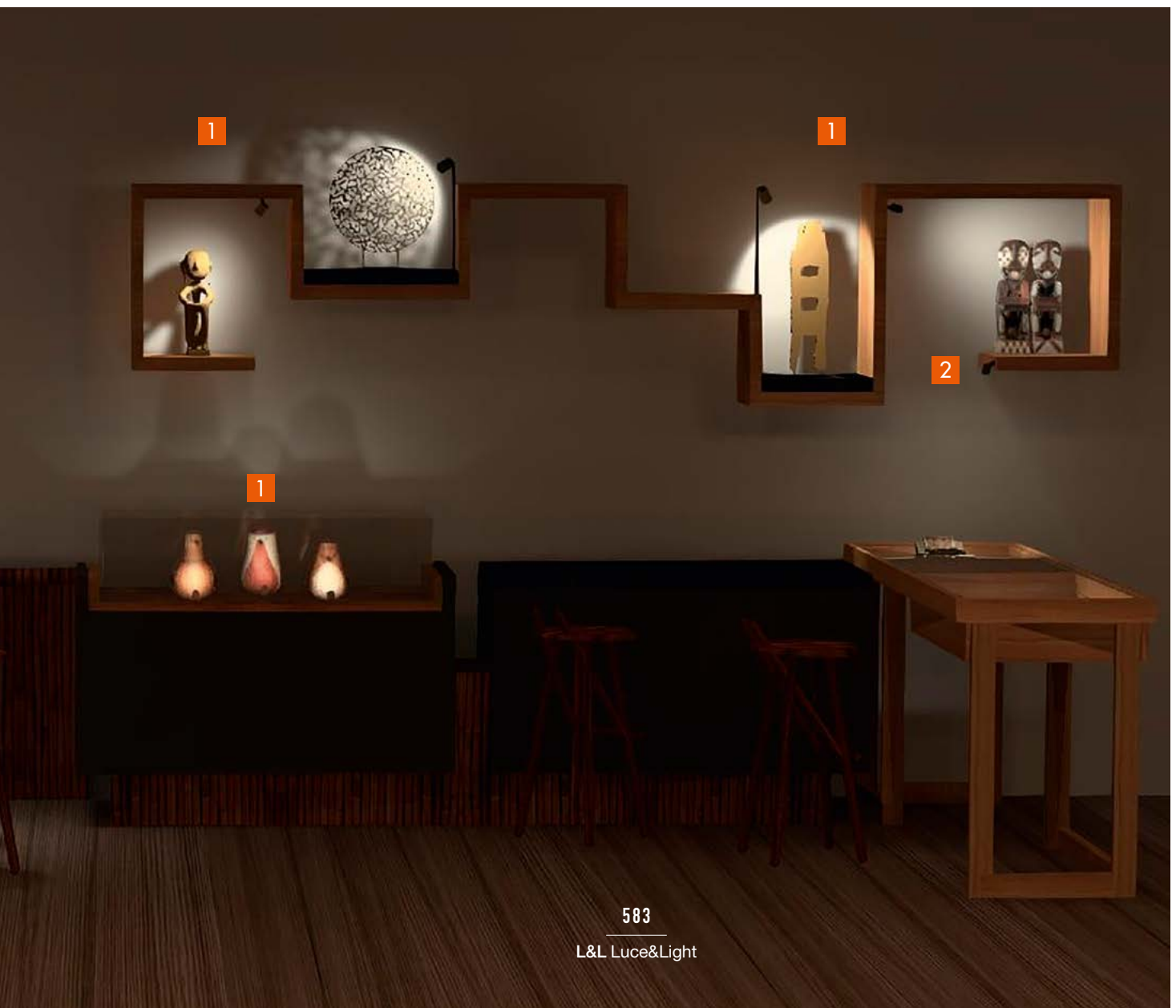

ACCENT LIGHTING IN RETAIL, MUSEUMS AND PRIVATE HOMES

KRILL p. 586 **1**

GEM p. 598 **2**



**ACCENT LIGHTING
IN RETAIL, MUSEUMS
AND PRIVATE HOMES**

		BEAM	LIGHT COLOUR	POWER	POWER SUPPLY
<p>KRILL see p. 586</p>  <p>MUSEUMS, RETAIL</p>		<p>FIXED FOCUS ZOOM LENS</p>	 <p>2700K 3000K 4000K</p>	<p>max 1–max 4.5W</p>	<p>CONSTANT CURRENT (power supply unit not included) max 350mA max 700mA</p>
<p>GEM see p. 598</p>  <p>MUSEUMS, RETAIL, PRIVATE HOMES</p>		<p>FIXED FOCUS</p>	 <p>2700K 3000K 4000K</p>	<p>max 1–max 4.5W</p>	<p>CONSTANT CURRENT (power supply unit not included) max 350mA max 700mA</p>



PROJECTORS FOR INDOOR APPLICATIONS

**DELIVERED LUMEN OUTPUT
(3000K)**

IP

**APPLIANCE
CLASS**

INSTALLATION

51-281 lm

IP40



showcases, display cabinets
shelf, ceiling, wall

61-280 lm

IP40



shelf, ceiling, wall





INDOOR PROJECTORS BUILD THE VERSION YOU WANT IN THREE STEPS

1 CHOOSE THE BODY



KRILL 1.0
FIXED FOCUS



KRILL 1.4
ZOOM LENS



KRILL 2.0
FIXED FOCUS



KRILL 2.4
ZOOM LENS



KRILL 3.0
FIXED FOCUS



KRILL 3.4
ZOOM LENS

2 CHOOSE THE REQUIRED INSTALLATION ACCESSORY

every accessory is compatible with all Krill products



FIXING
BASE



CEILING
ROSE



MAGNETIC
PLATE



FIXING
SPRING



NIPPLE
COUPLER

3 COMPLETE YOUR CHOICE WITH OPTIONAL ACCESSORIES



SNOOT
only compatible with
Krill 2.0 and Krill 3.0



HONEYCOMB LOUVRE
only compatible with
Krill 2.0 and Krill 3.0



ARM - 150 mm or 300 mm
only compatible with
fixing base and nipple coupler

< **KRILL 1.0**
3000K, 1W, 40°x26°, antique bronze
KRILL 3.4
3000K, 4.5W, optical range 18°-80°,
antique bronze, with rigid arm





INDOOR PROJECTORS DISPLAY LIGHTING FOR MUSEUMS AND RETAIL SETTINGS

2700K 3000K 4000K

Ø18 mm

Ø25 mm

Ø30 mm



narrow medium wide elliptical



KRILL 1.0 p. 592
max 1W max 350mA



KRILL 2.0 p. 593
max 2.5W max 700mA



KRILL 3.0 p. 595
max 4.5W max 350mA



zoom lens



KRILL 1.4 p. 592
max 1W max 350mA



KRILL 2.4 p. 593
max 2.5W max 700mA



KRILL 3.4 p. 595
max 4.5W max 350mA

< **KRILL 1.0**
3000K, 1W, 23°, black, customized ceiling rose
Project by / arch. Mariangela Alicino, Archingegno
Photo by / Alessio Tamborini
Residential building, Andria, Italy

16°



COMPACT DIMENSIONS AND PARED-DOWN DESIGN FOR LIGHTING INSIDE SHOWCASES AND DISPLAY CABINETS IN THE RETAIL AND MUSEUM SECTORS



CRI >90
THE ENTIRE KRILL RANGE USES LED LIGHT SOURCES WITH A HIGH COLOUR RENDERING INDEX

KRILL IS AVAILABLE WITH EITHER FIXED OPTICS OR A ZOOM LENS WITH WHICH THE ANGLE OF THE LIGHT BEAM CAN BE ADJUSTED AND ADAPTED AS THE OBJECTS DISPLAYED CHANGE



THE ARM'S DOUBLE JOINT MEANS KRILL CAN BE ADJUSTED BY UP TO 180°

42°

21°x50°

50°x21°



18°

80°



UNIQUE SELLING POINTS



KRILL HAS A WIDE RANGE OF ACCESSORIES TO ENABLE IT TO EASILY REACH THE DETAILS TO BE EMPHASISED



RAL FINISH
ON REQUEST



ROSE GOLD



ANTIQUE BRONZE



WHITE



BLACK



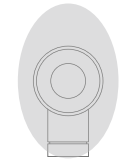

40°x26° optics
(Krill 1.0)

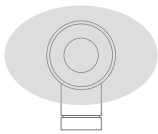
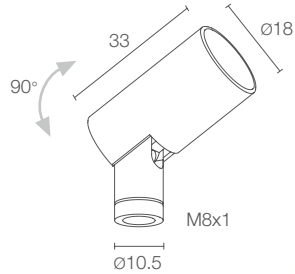

26°x40° optics
(Krill 1.0)



KRILL 1.0

Required installation accessories, not included



POWER / POWER SUPPLY CODE

max 1W max 350mA	
KI10201000 ■ O ■ E	White
KI10201000 ■ O ■ N	Black
KI10201000 ■ O ■ Y	Rose gold
KI10201000 ■ O ■ Z	Antique bronze

LED COLOUR

F - 2700K
5 - 3000K
9 - 4000K

OPTICS

M - 23°
L - 36°
J - 48°
W - 26°x40°
X - 40°x26°

LUMEN OUTPUT AT SOURCE	105 lm (3000K, 350mA)
DELIVERED LUMEN OUTPUT	51 lm (3000K, 350mA, 36°)
NO. AND TYPE OF LED	1 power LED 3-step MacAdam, 50000h L90 B10 (Ta 25°C)
MATERIAL	body in anticorodal aluminium joint in brass
POWER SUPPLY UNIT	not included, see p. 904
POWER CABLES	includes 1.5 m PVC cable HT105° 2x0.20 Ø3.0 mm
WIRING	series
MOUNTING	surface mounted (showcase, display cabinet shelf, ceiling, wall)
ACCESSORIES	see p. 596 and 597
FEATURES	CRI >90
PHOTOMETRIC DATA	see p. 842

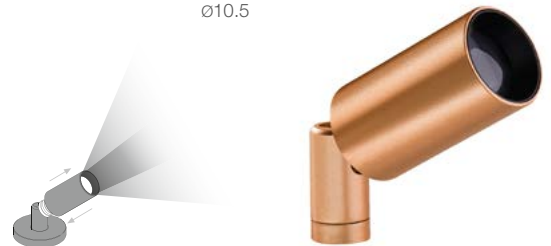
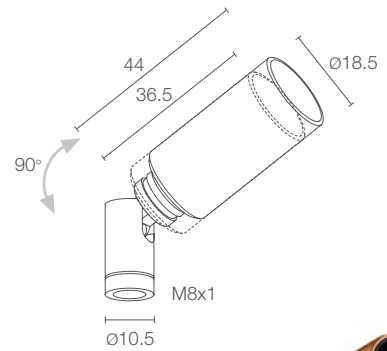

KRILL 1.4

Required installation accessories, not included



max 1W max 350mA	
KI14201000 ■ R1 ■ E	White
KI14201000 ■ R1 ■ N	Black
KI14201000 ■ R1 ■ Y	Rose gold
KI14201000 ■ R1 ■ Z	Antique bronze

F - 2700K
5 - 3000K
9 - 4000K

optical range 22°-64°

LUMEN OUTPUT AT SOURCE	105 lm (3000K, 350mA)
DELIVERED LUMEN OUTPUT	60 lm (3000K, 350mA, 64°)
NO. AND TYPE OF LED	1 power LED 3-step MacAdam, 50000h L90 B10 (Ta 25°C)
MATERIAL	body in anticorodal aluminium joint in brass
POWER SUPPLY UNIT	not included, see p. 904
POWER CABLES	includes 1.5 m PVC cable HT105° 2x0.20 Ø3.0 mm
WIRING	series
MOUNTING	surface mounted (showcase, display cabinet shelf, ceiling, wall)
ACCESSORIES	see p. 596 and 597
FEATURES	CRI >90
PHOTOMETRIC DATA	see p. 842

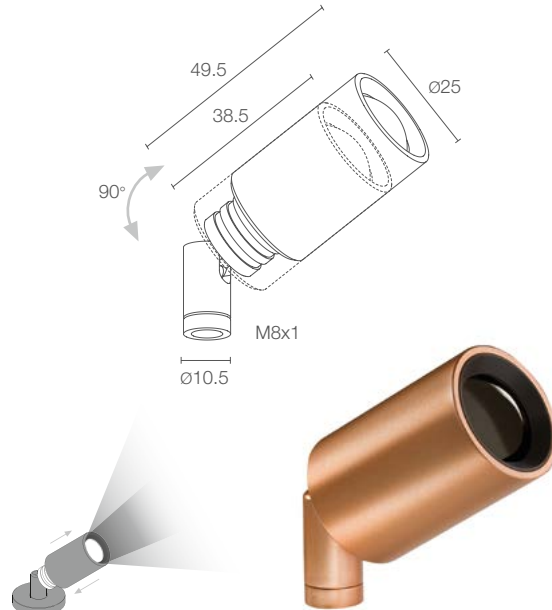
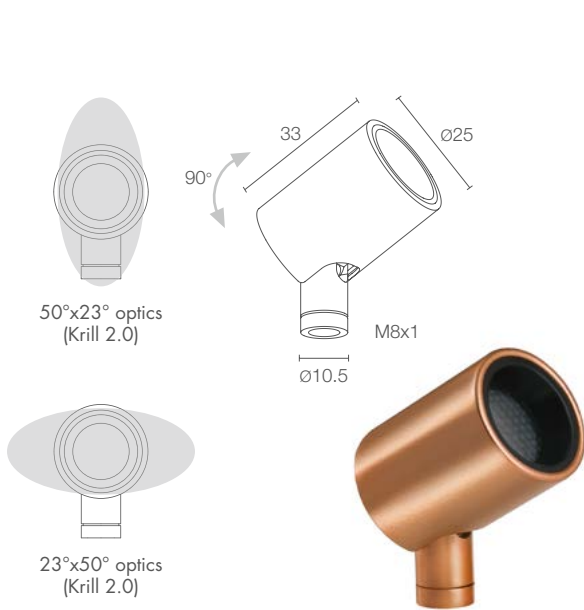

KRILL 2.0

Required installation accessories, not included

CE CB EAC LED TECH III kg 0.05 IP40
 A A+ A++ CASAMBI

max 2.5W max 700mA
KI20201000 ■ **O** ■ **E** White
KI20201000 ■ **O** ■ **N** Black
KI20201000 ■ **O** ■ **Y** Rose gold
KI20201000 ■ **O** ■ **Z** Antique bronze

■ **F** - 2700K
5 - 3000K
9 - 4000K

■ **S** - 17°
M - 25°
L - 33°
W - 23°x50°
X - 50°x23°

202 lm (3000K, 700mA)

150 lm (3000K, 700mA, 17°)

1 power LED
 1/4 ANSI BIN, 50000h L90 B10 (Ta 25°C)

body in anticorodal aluminium
 joint in brass

not included, see p. 904

includes 1.5 m PVC cable
 HT105° 2x0.20 Ø3.0 mm

series

surface mounted (showcase, display cabinet
 shelf, ceiling, wall)

see p. 596 and 597

CRI >90

see p. 842 and 843

KRILL 2.4

Required installation accessories, not included

CE CB EAC LED TECH III kg 0.065 IP40
 A A+ A++ CASAMBI

max 2.5W max 700mA
KI24201000 ■ **R1 E** White
KI24201000 ■ **R1 N** Black
KI24201000 ■ **R1 Y** Rose gold
KI24201000 ■ **R1 Z** Antique bronze

■ **F** - 2700K
5 - 3000K
9 - 4000K

optical range 9°-70°

202 lm (3000K, 700mA)

176 lm (3000K, 700mA, 70°)

1 power LED
 1/4 ANSI BIN, 50000h L90 B10 (Ta 25°C)

body in anticorodal aluminium
 joint in brass

not included, see p. 904

includes 1.5 m PVC cable
 HT105° 2x0.20 Ø3.0 mm

series

surface mounted (showcase, display cabinet
 shelf, ceiling, wall)

see p. 596 and 597

CRI >90

see p. 843

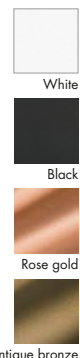



594

L&L Luce&Light

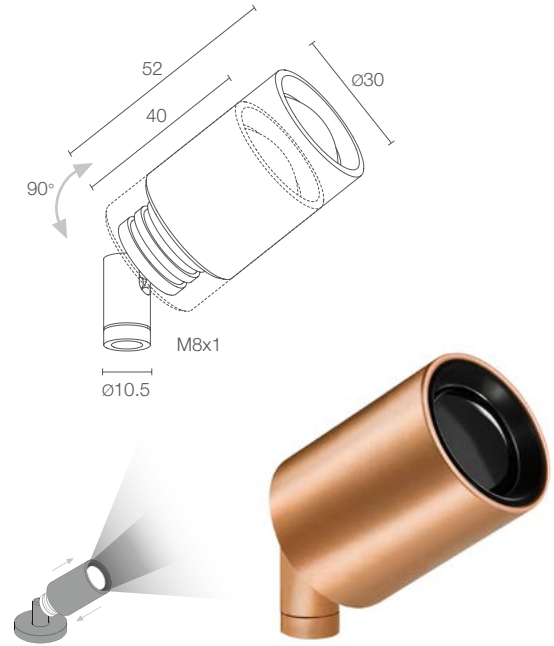
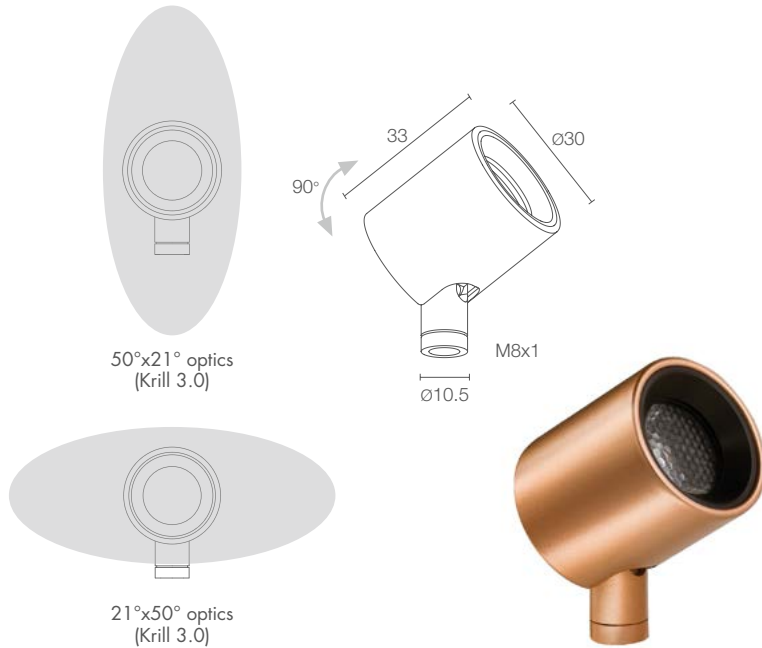

KRILL 3.0

Required installation accessories, not included



POWER / POWER SUPPLY CODE

max 4.5W max 350mA
KI30201000 ■ O ■ E White
KI30201000 ■ O ■ N Black
KI30201000 ■ O ■ Y Rose gold
KI30201000 ■ O ■ Z Antique bronze

LED COLOUR

F - 2700K
5 - 3000K
9 - 4000K

OPTICS

S - 16°
M - 23°
L - 33°
K - 42°
W - 21°x50°
X - 50°x21°

LUMEN OUTPUT AT SOURCE	452 lm (3000K, 350mA)
DELIVERED LUMEN OUTPUT	281 lm (3000K, 350mA, 23°)
NO. AND TYPE OF LED	1 high-intensity power LED 3-step MacAdam, 50000h L90 B10 (Ta 25°C)
MATERIAL	body in anticorrosional aluminium joint in brass
POWER SUPPLY UNIT	not included, see p. 904
POWER CABLES	includes 1.5 m PVC cable HT105° 2x0.20 Ø3.0 mm
WIRING	series
MOUNTING	surface mounted (showcase, display cabinet shelf, ceiling, wall)
ACCESSORIES	see p. 596 and 597
FEATURES	CRI >90
PHOTOMETRIC DATA	see p. 843

KRILL 3.4

Required installation accessories, not included



max 4.5W max 350mA

KI34201000 ■ R1 ■ E White
KI34201000 ■ R1 ■ N Black
KI34201000 ■ R1 ■ Y Rose gold
KI34201000 ■ R1 ■ Z Antique bronze

F - 2700K
5 - 3000K
9 - 4000K

optical range 18°-80°

LUMEN OUTPUT AT SOURCE	452 lm (3000K, 350mA)
DELIVERED LUMEN OUTPUT	253 lm (3000K, 350mA, 80°)
NO. AND TYPE OF LED	1 high-intensity power LED 3-step MacAdam, 50000h L90 B10 (Ta 25°C)
MATERIAL	body in anticorrosional aluminium joint in brass
POWER SUPPLY UNIT	not included, see p. 904
POWER CABLES	includes 1.5 m PVC cable HT105° 2x0.20 Ø3.0 mm
WIRING	series
MOUNTING	surface mounted (showcase, display cabinet shelf, ceiling, wall)
ACCESSORIES	see p. 596 and 597
FEATURES	CRI >90
PHOTOMETRIC DATA	see p. 843

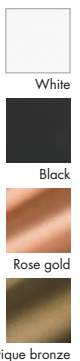

< **KRILL 2.4**
 3000K, 2.5W, optical range 9°-70°
 rose gold, with magnetic plates on an iron pole

ANTI-GLARE ACCESSORIES



WHK120AO (Krill 2.0)
WHK130AO (Krill 3.0)
 Honeycomb louvre

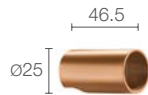

WBA00E - White
WBA00N - Black
WBA00Y - Rose gold
WBA00Z - Antique bronze
 Standard snoot
 (Krill 2.0)

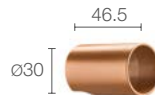

WBA01E - White
WBA01N - Black
WBA01Y - Rose gold
WBA01Z - Antique bronze
 Standard snoot
 (Krill 3.0)

ACCESSORIES FOR INSTALLATION



WDA00E - White
WDA00N - Black
WDA00Y - Rose gold
WDA00Z - Antique bronze
 Fixing base



WDA03E - White
WDA03N - Black
WDA03Y - Rose gold
WDA03Z - Antique bronze
 Ceiling rose



WDA04E - White
WDA04N - Black
WDA04Y - Rose gold
WDA04Z - Antique bronze
 Magnetic plate

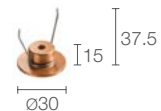

WGA08E - White
WGA08N - Black
WGA08Y - Rose gold
WGA08Z - Antique bronze
 Fixing spring Ø30 mm



h 150 mm
WDA01E - White
WDA01N - Black
WDA01Y - Rose gold
WDA01Z - Antique bronze

h 300 mm
WDA02E - White
WDA02N - Black
WDA02Y - Rose gold
WDA02Z - Antique bronze

Rigid arm
 order together with the fixing
 base or the nipple coupler



WGA01
 Nipple coupler

Required installation accessories, not included



ACCESSORIES

POWER CABLES

PVC cable
HT105° 2x0.20 Ø3.0 mm
your choice of length

WF0600

order together with the lighting fixture

▼

KRILL 3.0

3000K, 4.5W, 42°, antique bronze, rigid arm 300 mm

Executed by / Scopel Impianti
Photo by / Tommy Ijai
Church of Madonna delle Grazie
Fonzaso, Belluno, Italy







INDOOR PROJECTOR LIGHTING FOR DISPLAY CASES IN MUSEUMS, HOMES AND RETAIL SETTINGS

2700K 3000K 4000K

Ø12 mm

Ø22 mm

Ø32 mm

narrow medium wide



GEM MINI 1 p. 600
max 1W max 350mA



GEM 1.1 p. 601
max 2.5W max 700mA



GEM 2.1 p. 601
max 4.5W max 350mA

< GEM 1.1
3000K, 2.5W, 42°, black

Project by / Studio ARCHH Lorenzo Agnese, Giovanni Guerrieri
Photo by / Alessio Tamborini
The Coeclerici Gallery, Galata Maritime Museum, Genoa, Italy

v

GEM 1.1
3000K, 2.5W, 42°, black

Project by / Studio ARCHH Lorenzo Agnese
Giovanni Guerrieri

Photo by / Alessio Tamborini
The Coeclerici Gallery, Galata Maritime Museum
Genoa, Italy

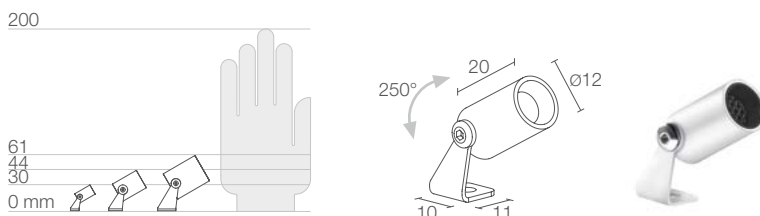

GEM MINI 1

CE LED TECH III kg 0.021 IP40

A A+ A++ CASAMBI

POWER / POWER SUPPLY CODE max 1W max 350mA
GE01201000 **0** **B** White
GE01201000 **0** **P** Pearl chrome
GE01201000 **0** **N** Black

■ HONEYCOMB LOUVRE

LED COLOUR **F** - 2700K
5 - 3000K
9 - 4000K

OPTICS **M** - 23°
F - 36°
L - 48°

LUMEN OUTPUT AT SOURCE	105 lm (3000K, 350mA)
DELIVERED LUMEN OUTPUT	51 lm (3000K, 350mA, 36°)
NO. AND TYPE OF LED	1 power LED 3-step MacAdam, 50000h L90 B10 (Ta 25°C)
MATERIAL	body in anticorrosion aluminium bracket in aluminium
POWER SUPPLY UNIT	not included, see p. 904
POWER CABLE	includes 1.5 m PVC cable HT105° 2x0.20 Ø3.0 mm
WIRING	series
MOUNTING	surface mounted (ceiling, wall, shelf, showcase)
ACCESSORIES	see p. 602 and 603
FEATURES	CRI >90
PHOTOMETRIC DATA	see p. 831

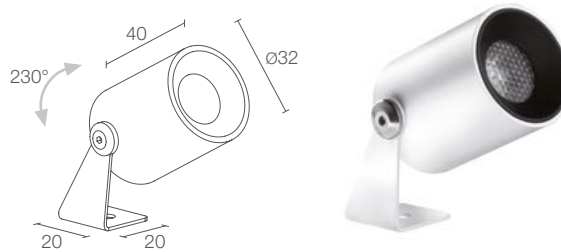
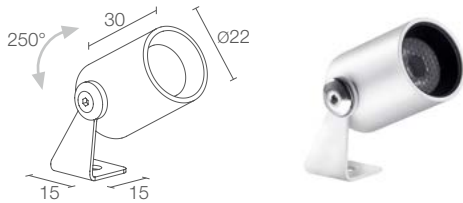

GEM 1.1

CE EAC LED TECH III kg 0.039 IP40

A A+ A++ CASAMBI

max 2.5W max 700mA

GE1120100 ■ ■ ■ **O B** White
GE1120100 ■ ■ ■ **O P** Pearl chrome
GE1120100 ■ ■ ■ **O N** Black

■	O - not present 1 - present
■	F - 2700K 5 - 3000K 9 - 4000K
■	S - 17° M - 23° F - 32° L - 42°

260 lm (3000K, 700mA)

160 lm (3000K, 700mA, 23°)

1 power LED
2-step MacAdam, 50000h L90 B10 (Ta 25°C)

body in anticorrosion aluminium
bracket in aluminium

not included, see p. 904

includes 1.5 m PVC cable
HT105° 2x0.20 Ø3.0 mm

series

surface mounted (ceiling, wall, shelf, showcase)

see p. 602 and 603

CRI >90

see p. 831

GEM 2.1

CE LED TECH III kg 0.073 IP40

A A+ A++ PID CASAMBI

max 4.5W max 350mA

GE2120100 ■ ■ ■ **O B** White
GE2120100 ■ ■ ■ **O P** Pearl chrome
GE2120100 ■ ■ ■ **O N** Black

■	O - not present 1 - present
■	F - 2700K 5 - 3000K 9 - 4000K
■	S - 16° M - 23° F - 33° L - 42°

452 lm (3000K, 350mA)

280 lm (3000K, 350mA, 23°)

1 high-intensity power LED
3-step MacAdam, 50000h L90 B10 (Ta 25°C)

body in anticorrosion aluminium
bracket in aluminium

not included, see p. 904

includes 1.5 m PVC cable
HT105° 2x0.20 Ø3.0 mm

series

surface mounted (ceiling, wall, shelf, showcase)

see p. 602 and 603

CRI >90

see p. 831

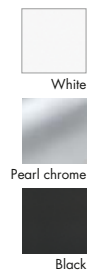

POWER CABLES

PVC cable
HT105° 2x0.20 Ø3.0 mm
your choice of length

WF0600 - Grey
WF4000 - Black

order together with the lighting fixture

▼
GEM MINI 1
3000K, 1W, 48°, pearl chrome
GEM 1.1
3000K, 2.5W, 42°, pearl chrome
GEM 2.1
3000K, 4.5W, 42°, pearl chrome

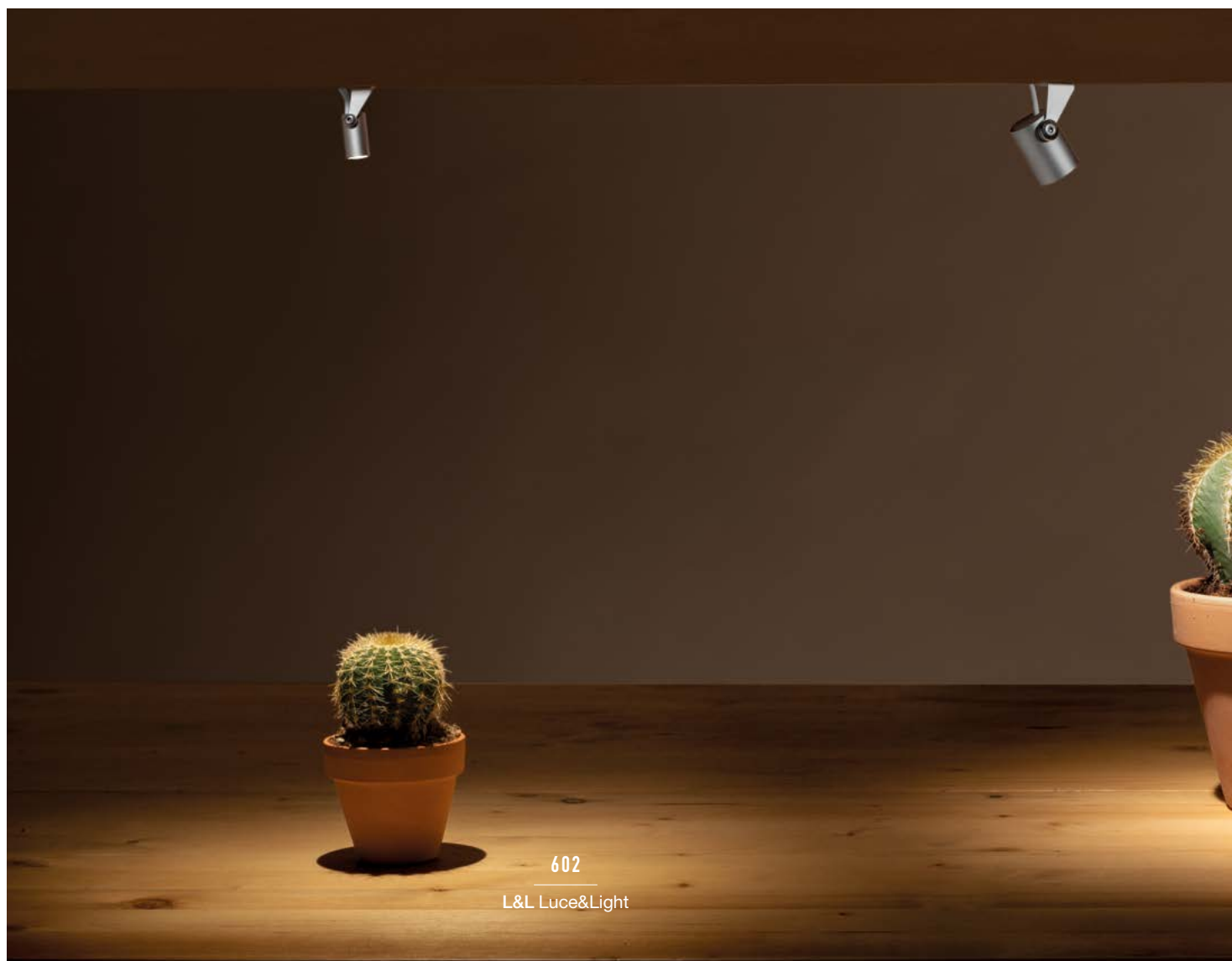



ACCESSORIES

CONTROL GEAR



Low-voltage converter with 350 mm cable to be used with constant-voltage power supply unit. Output: 350mA constant, max 8.4W

WFA024350

(Gem Mini 1, Gem 1.1 / 2.1)



Low-voltage converter with 350 mm cable to be used with constant-voltage power supply unit. Output: 500mA constant, max 12W

WFA024500

(Gem 1.1)



Low-voltage converter with 350 mm cable to be used with constant-voltage power supply unit. Output: 700mA constant, max 16.8W

WFA024700

(Gem 1.1)

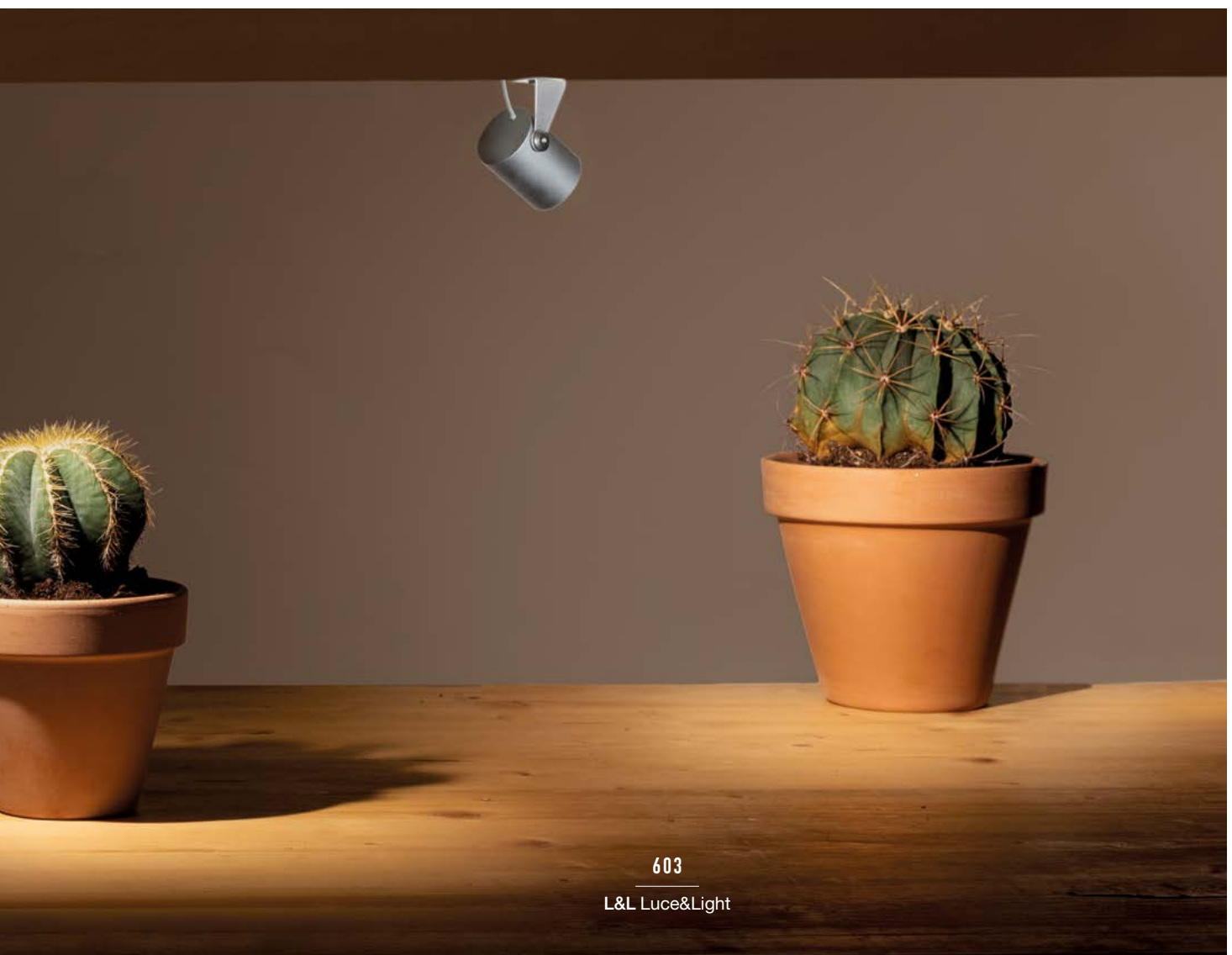



1

3

WALL MOUNTED FOR INDOOR APPLICATIONS

HOSPITALITY, PRIVATE HOMES

BERICA IN p. 608 **1**

ELLA IN p. 622 **2**





VERSA p. 628 **3**



605

L&L Luce&Light

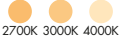
**HOSPITALITY,
PRIVATE HOMES**

	OPTICS	BEAM	LIGHT COLOUR
BERICA IN see p. 608 	DIFFUSE ELLIPTICAL ASYMMETRICAL	DOUBLE BEAM	 2700K 3000K 4000K
ELLA IN see p. 622 	DIFFUSE	SINGLE BEAM	 2700K 3000K 4000K
VERSA see p. 628 	DIFFUSE	SINGLE BEAM DOUBLE BEAM	 2700K 3000K 4000K

WALL MOUNTED FOR INDOOR APPLICATIONS

POWER SUPPLY	POWER SUPPLY UNIT	IP	APPLIANCE CLASS
230Vac	built in	IP40	□
230Vac	built in	IP40	⊕
230Vac	built in	IP40	⊕



INDOOR WALL MOUNTED DOUBLE BEAM

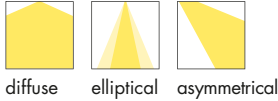

diffuse elliptical asymmetrical



2700K 3000K 4000K

INDOOR WALL MOUNTED

120 mm

340 mm

620 mm

CONVEX COVER



BERICA IN 1.0
p. 312
8W 230Vac
ON/OFF



BERICA IN 1.1
p. 613
27W 230Vac
ON/OFF, DALI+PUSH



BERICA IN 1.2
p. 613
54W 230Vac
ON/OFF, DALI+PUSH

FLAT COVER



BERICA IN 2.0
p. 614
8W 230Vac
ON/OFF



BERICA IN 2.1
p. 615
27W 230Vac
ON/OFF, DALI+PUSH



BERICA IN 2.2
p. 615
54W 230Vac
ON/OFF, DALI+PUSH

CONCAVE COVER



BERICA IN 3.0
p. 616
8W 230Vac
ON/OFF



BERICA IN 3.1
p. 617
27W 230Vac
ON/OFF, DALI+PUSH



BERICA IN 3.2
p. 617
54W 230Vac
ON/OFF, DALI+PUSH

OUTDOOR WALL MOUNTED

BERICA OUT
p. 316

INDOOR SUSPENDED

BERICA S
p. 668



230
Vac

BUILT-IN POWER
SUPPLY UNIT

DALI

DALI
AVAILABLE IN A DALI DIMMABLE VERSION
IN THE LENGTHS 340 MM AND 620 MM

CRI >90

BERICA IN USES LED LIGHT SOURCES WITH
A HIGH COLOUR RENDERING INDEX

BODY AND COVER MADE OF
LOW-COPPER-CONTENT ANTICORODAL
ALUMINIUM ALLOY EN AW 6060 T5 FOR
EXCELLENT RESISTANCE TO CORROSION

WITH THE ASYMMETRICAL OPTICS,
THE LIGHT OUTPUT CAN REACH
BOTH FLOOR AND CEILING IN
CORRIDORS AND PASSAGEWAYS

OUTDOOR VERSION: BERICA OUT, PAGE 316
SUSPENDED VERSION: BERICA S, PAGE 668

UNIQUE SELLING POINTS



RAL FINISH
ON REQUEST



ANTIQUÉ BRONZE



WHITE



ANTIQUÉ WHITE



MATT ALUMINIUM GREY



SLIM DESIGN:
COMPACT FIXTURE
WITH A THICKNESS
OF JUST 30 MM



THREE DIFFERENT
TYPES OF COVER:
CONVEX, FLAT
AND CONCAVE

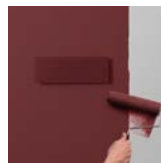

ON THE VERSION COVERED
IN A NEUTRAL, BONDING
PRIMER, THE SURFACE OF
BERICA'S IN COVER CAN BE
FINISHED IN THE SAME PAINT
AS THE WALL IT'S ON OR
COVERED IN WALLPAPER,
FOCUSING ATTENTION ON
THE LIGHT OUTPUT ALONE



^
BERICA IN 1.2
 4000K, 54W, diffuse, primer version with wallpaper

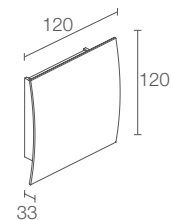

BERICA IN 1.0

CE ENEC LED TECH kg 0.35 IP40
 A A+ A++

POWER / POWER SUPPLY CODE

8W 230Vac
BB10101000 ■ **B** White
BB10101000 ■ **6** Antique white
BB10101000 ■ **Z** Antique bronze
BB10101000 ■ **K** Matt aluminium grey
BB10101000 ■ **8** Primer

CONTROL SYSTEM

on/off

LED COLOUR

F - 2700K
5 - 3000K
9 - 4000K

OPTICS

OA - asymmetrical
OD - diffuse
LW - 43°x96°
KW - 54°x90°

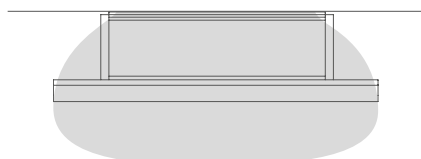

Asymmetrical optics



Diffuse optics

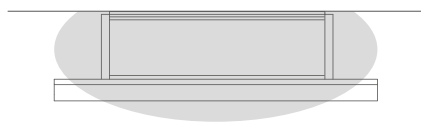

43°x96° optics

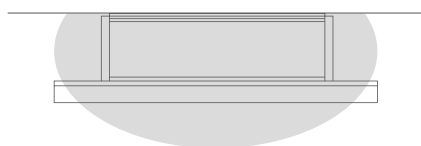

54°x90° optics

LUMEN OUTPUT AT SOURCE	820 lm (3000K)
DELIVERED LUMEN OUTPUT	656 lm (3000K, 43°x96°)
NO. AND TYPE OF LED	16 mid-power LEDs 3-step MacAdam, 50000h L80 B10 (Ta 25°C)
MATERIAL	body and cover in anticorrosion aluminium
POWER SUPPLY UNIT	built in
MOUNTING	surface mounted (wall)
FEATURES	CRI >90
NOTES	outdoor version: Berica OUT 1, p. 318 suspended version: Berica S 1, p. 670 non-standard lengths and single-beam version available on request Casambi-compatible version, controllable with the Casambi app, available on request
PHOTOMETRIC DATA	see p. 782

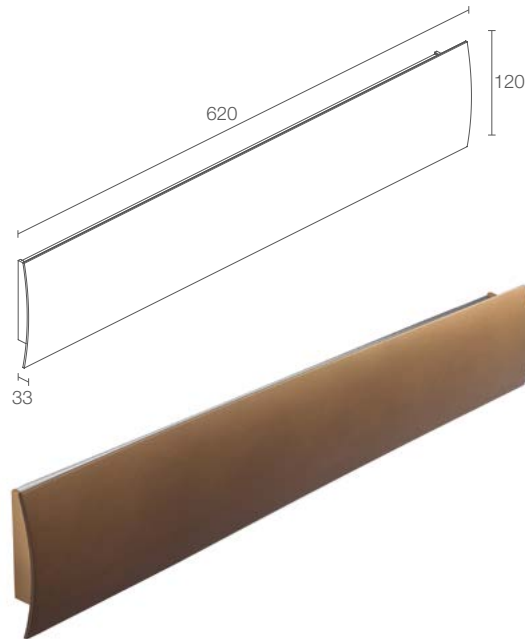
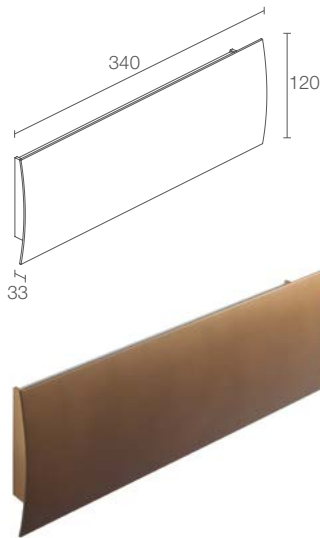

BERICA IN 1.1

CE ENEC LED TECH IP40 DALI PUSH
 A A+ A++

27W 230Vac
BB11101 ■ **00** ■ **B** White
BB11101 ■ **00** ■ **6** Antique white
BB11101 ■ **00** ■ **Z** Antique bronze
BB11101 ■ **00** ■ **K** Matt aluminium grey
BB11101 ■ **00** ■ **8** Primer

■	O - on/off D - DALI+PUSH
■	F - 2700K 5 - 3000K 9 - 4000K
■	OA - asymmetrical OD - diffuse LW - 43°x96° KW - 54°x90°

3280 lm (3000K)

2624 lm (3000K, 43°x96°)

64 mid-power LEDs
 3-step MacAdam, 50000h L80 B10 (Ta 25°C)

body and cover in anticorrosion aluminium

built in

surface mounted (wall)

CRI >90

outdoor version: Berica OUT 1, p. 318
 suspended version: Berica S 1, p. 670
 non-standard lengths and
 single-beam version available on request
 Casambi-compatible version, controllable with
 the Casambi app, available on request

see p. 782

BERICA IN 1.2

CE ENEC LED TECH IP40 DALI PUSH
 A A+ A++

54W 230Vac
BB12101 ■ **00** ■ **B** White
BB12101 ■ **00** ■ **6** Antique white
BB12101 ■ **00** ■ **Z** Antique bronze
BB12101 ■ **00** ■ **K** Matt aluminium grey
BB12101 ■ **00** ■ **8** Primer

■	O - on/off D - DALI+PUSH
■	F - 2700K 5 - 3000K 9 - 4000K
■	OA - asymmetrical OD - diffuse LW - 43°x96° KW - 54°x90°

6560 lm (3000K)

5248 lm (3000K, 43°x96°)

128 mid-power LEDs
 3-step MacAdam, 50000h L80 B10 (Ta 25°C)

body and cover in anticorrosion aluminium

built in

surface mounted (wall)

CRI >90

outdoor version: Berica OUT 1, p. 318
 suspended version: Berica S 1, p. 670
 non-standard lengths and
 single-beam version available on request
 Casambi-compatible version, controllable with
 the Casambi app, available on request

see p. 782





^
BERICA IN 2.1
 3000K, 27W, 45°x96°, antique bronze
 Courtesy of / Désirée Divani

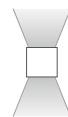
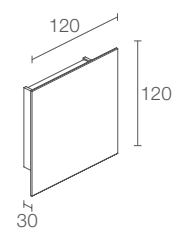

BERICA IN 2.0

CE ENEC LED TECH kg 0.35 IP40
 A A+ A++

POWER / POWER SUPPLY CODE

8W 230Vac
BB20101000 ■ **B** White
BB20101000 ■ **6** Antique white
BB20101000 ■ **Z** Antique bronze
BB20101000 ■ **K** Matt aluminium grey
BB20101000 ■ **8** Primer

CONTROL SYSTEM

on/off

LED COLOUR

F - 2700K
5 - 3000K
9 - 4000K

OPTICS

OA - asymmetrical
OD - diffuse
LW - 45°x96°
KW - 57°x90°



Asymmetrical optics

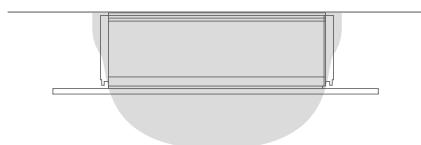

Diffuse optics



45°x96° optics



57°x90° optics

LUMEN OUTPUT AT SOURCE	820 lm (3000K)
DELIVERED LUMEN OUTPUT	670 lm (3000K, 45°x96°)
NO. AND TYPE OF LED	16 mid-power LEDs 3-step MacAdam, 50000h L80 B10 (Ta 25°C)
MATERIAL	body and cover in anticorrosion aluminium
POWER SUPPLY UNIT	built in
MOUNTING	surface mounted (wall)
FEATURES	CRI >90
NOTES	outdoor version: Berica OUT 2, p. 320 suspended version: Berica S 2, p. 672 non-standard lengths and single-beam version available on request Casambi-compatible version, controllable with the Casambi app, available on request
PHOTOMETRIC DATA	see p. 783

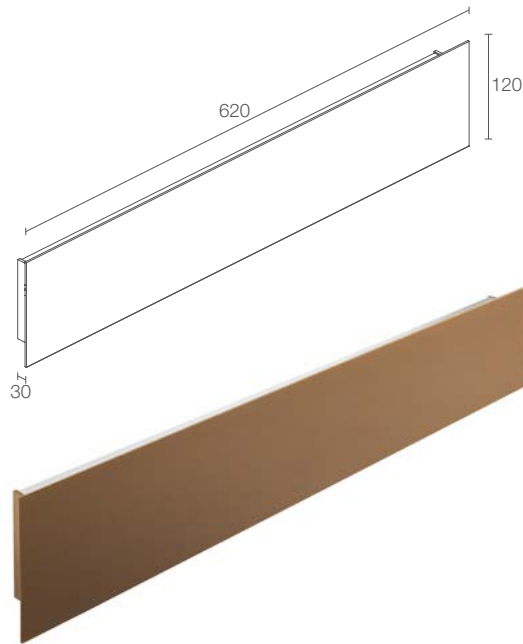
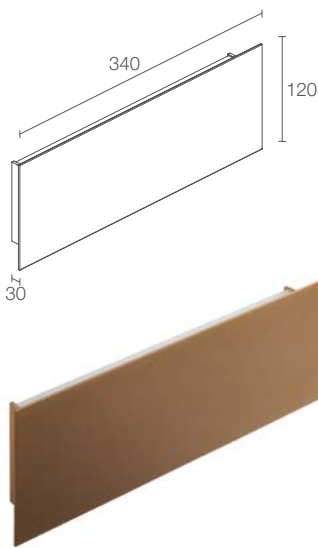

BERICA IN 2.1



CE ENEC LED TECH kg 0.90 IP40 DALI PUSH
 A A+ A++

27W 230Vac

BB21101 ■ **00** ■ **B** White
BB21101 ■ **00** ■ **6** Antique white
BB21101 ■ **00** ■ **Z** Antique bronze
BB21101 ■ **00** ■ **K** Matt aluminium grey
BB21101 ■ **00** ■ **8** Primer

■ **O** - on/off
D - DALI+PUSH

■ **F** - 2700K
5 - 3000K
9 - 4000K

■ **OA** - asymmetrical
OD - diffuse
LW - 45°x96°
KW - 57°x90°

3280 lm (3000K)

2680 lm (3000K, 45°x96°)

64 mid-power LEDs
 3-step MacAdam, 50000h L80 B10 (Ta 25°C)

body and cover in anticorrosion aluminium

built in

surface mounted (wall)

CRI >90

outdoor version: Berica OUT 2, p. 320
 suspended version: Berica S 2, p. 672
 non-standard lengths and
 single-beam version available on request
 Casambi-compatible version, controllable with
 the Casambi app, available on request

see p. 783

BERICA IN 2.2

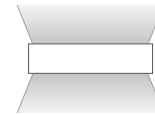

CE ENEC LED TECH kg 1.60 IP40 DALI PUSH
 A A+ A++

54W 230Vac

BB22101 ■ **00** ■ **B** White
BB22101 ■ **00** ■ **6** Antique white
BB22101 ■ **00** ■ **Z** Antique bronze
BB22101 ■ **00** ■ **K** Matt aluminium grey
BB22101 ■ **00** ■ **8** Primer

■ **O** - on/off
D - DALI+PUSH

■ **F** - 2700K
5 - 3000K
9 - 4000K

■ **OA** - asymmetrical
OD - diffuse
LW - 45°x96°
KW - 57°x90°

6560 lm (3000K)

5360 lm (3000K, 45°x96°)

128 mid-power LEDs
 3-step MacAdam, 50000h L80 B10 (Ta 25°C)

body and cover in anticorrosion aluminium

built in

surface mounted (wall)

CRI >90

outdoor version: Berica OUT 2, p. 320
 suspended version: Berica S 2, p. 672
 non-standard lengths and
 single-beam version available on request
 Casambi-compatible version, controllable with
 the Casambi app, available on request

see p. 783





^
BERICA IN 2.1
 3000K, 27W, 57°x90°, antique bronze

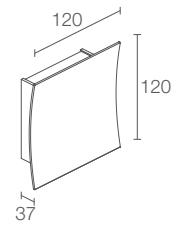

BERICA IN 3.0

CE ENEC LED TECH kg 0.35 IP40
 A A+ A++

POWER / POWER SUPPLY CODE

8W 230Vac
BB30101000 ■ **B** White
BB30101000 ■ **6** Antique white
BB30101000 ■ **Z** Antique bronze
BB30101000 ■ **K** Matt aluminium grey
BB30101000 ■ **8** Primer

CONTROL SYSTEM

on/off

LED COLOUR

F - 2700K
5 - 3000K
9 - 4000K

OPTICS

0A - asymmetrical
0D - diffuse
LW - 45°x96°
KW - 59°x90°



Asymmetrical optics



Diffuse optics

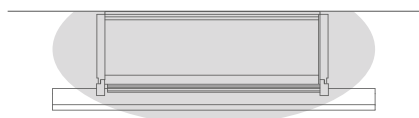

45°x96° optics



59°x90° optics

LUMEN OUTPUT AT SOURCE	820 lm (3000K)
DELIVERED LUMEN OUTPUT	682 lm (3000K, diffuse optics)
NO. AND TYPE OF LED	16 mid-power LEDs 3-step MacAdam, 50000h L80 B10 (Ta 25°C)
MATERIAL	body and cover in anticorrosion aluminium
POWER SUPPLY UNIT	built in
MOUNTING	surface mounted (wall)
FEATURES	CRI >90
NOTES	outdoor version: Berica OUT 3, p. 322 suspended version: Berica S 3, p. 674 non-standard lengths and single-beam version available on request Casambi-compatible version, controllable with the Casambi app, available on request
PHOTOMETRIC DATA	see p. 784

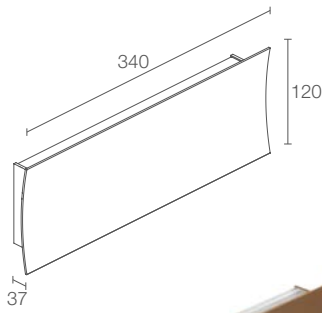

BERICA IN 3.1

CE ENEC LED TECH kg 0.90 IP40 DALI PUSH

27W 230Vac

BB31101 **B** White
BB31101 **6** Antique white
BB31101 **Z** Antique bronze
BB31101 **K** Matt aluminium grey
BB31101 **8** Primer

O - on/off
D - DALI+PUSH

F - 2700K
5 - 3000K
9 - 4000K

OA - asymmetrical
OD - diffuse
LW - 45°x96°
KW - 59°x90°

3280 lm (3000K)

2728 lm (3000K, diffuse optics)

64 mid-power LEDs
 3-step MacAdam, 50000h L80 B10 (Ta 25°C)

body and cover in anticorrosional aluminium

built in

surface mounted (wall)

CRI >90

outdoor version: Berica OUT 3, p. 322
 suspended version: Berica S 3, p. 674
 non-standard lengths and
 single-beam version available on request
 Casambi-compatible version, controllable with
 the Casambi app, available on request

see p. 784

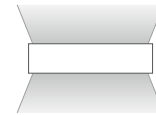
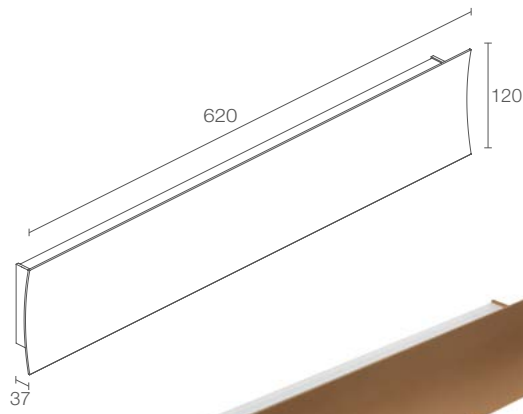

BERICA IN 3.2

CE ENEC LED TECH kg 1.60 IP40 DALI PUSH

54W 230Vac

BB32101 **B** White
BB32101 **6** Antique white
BB32101 **Z** Antique bronze
BB32101 **K** Matt aluminium grey
BB32101 **8** Primer

O - on/off
D - DALI+PUSH

F - 2700K
5 - 3000K
9 - 4000K

OA - asymmetrical
OD - diffuse
LW - 45°x96°
KW - 59°x90°

6560 lm (3000K)

5456 lm (3000K, diffuse optics)

128 mid-power LEDs
 3-step MacAdam, 50000h L80 B10 (Ta 25°C)

body and cover in anticorrosional aluminium

built in

surface mounted (wall)

CRI >90

outdoor version: Berica OUT 3, p. 322
 suspended version: Berica S 3, p. 674
 non-standard lengths and
 single-beam version available on request
 Casambi-compatible version, controllable with
 the Casambi app, available on request

see p. 784



BERICA IN 2.1

Installation height: 1.80 m; ceiling height: 3 metres

0A - Asymmetrical

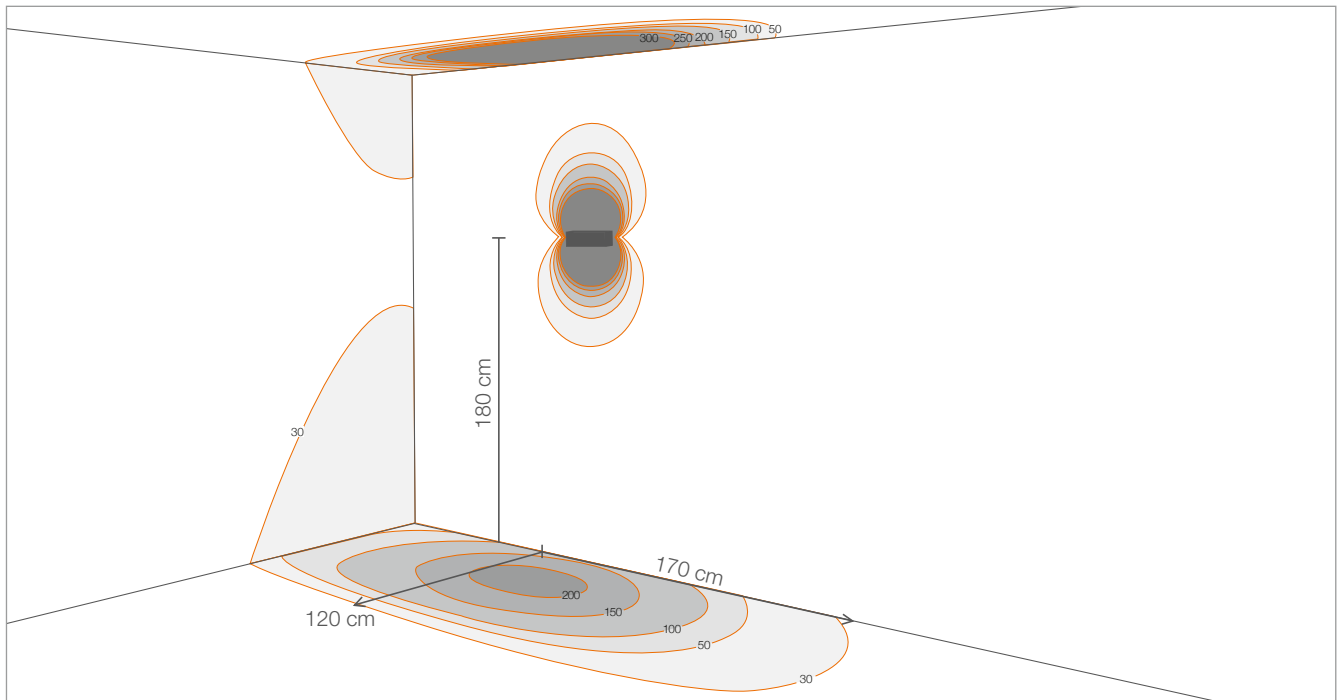

0D - Diffuse

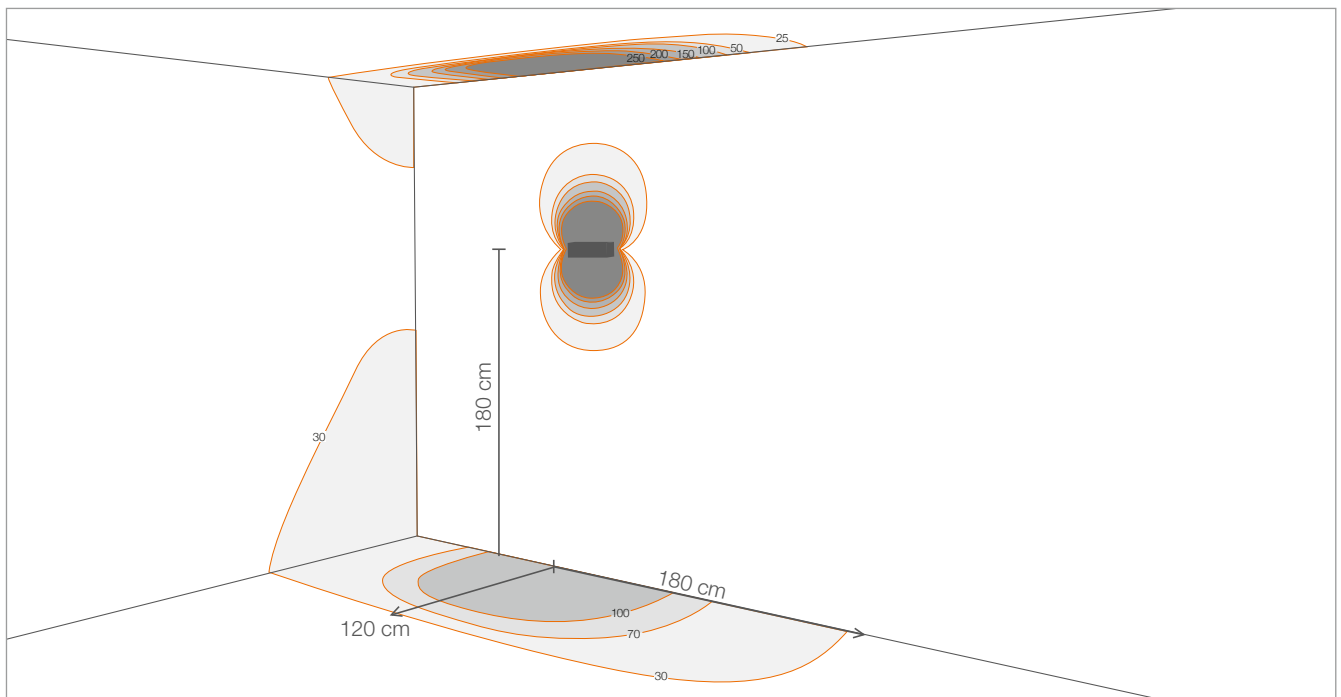

POSITIONING DIAGRAMS

LW - 45°x96°

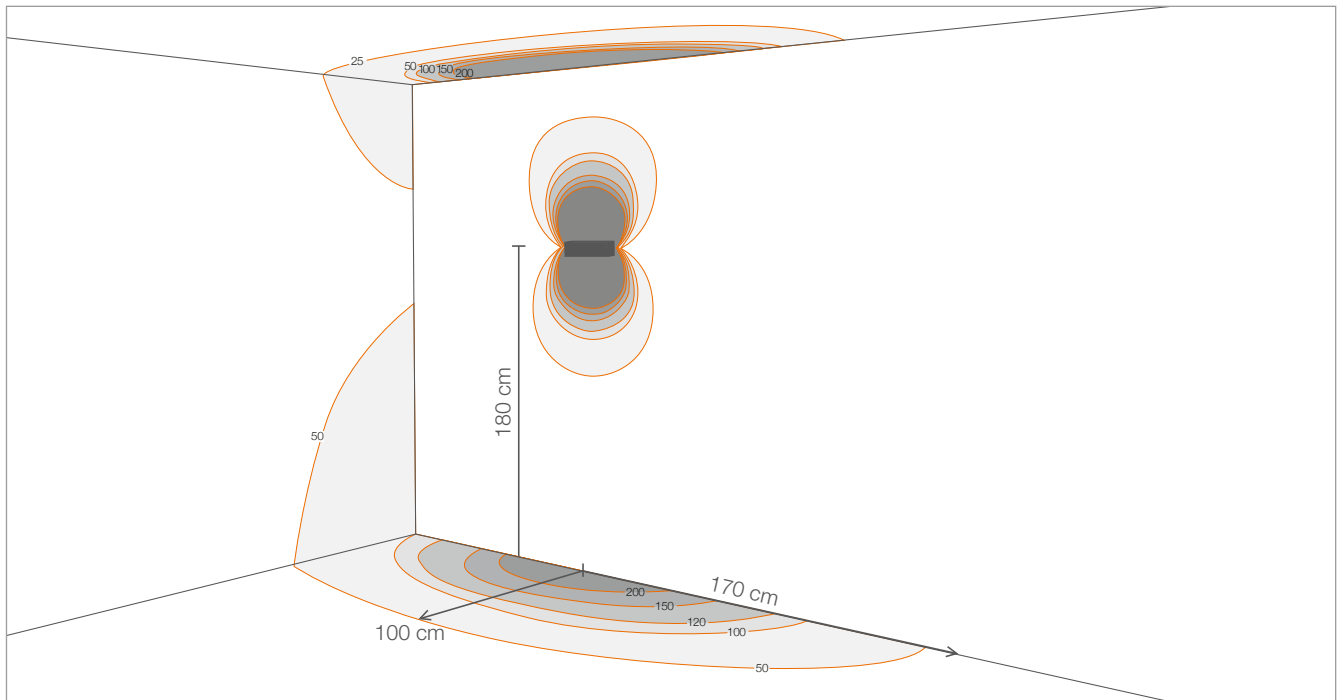

KW - 57°x90°

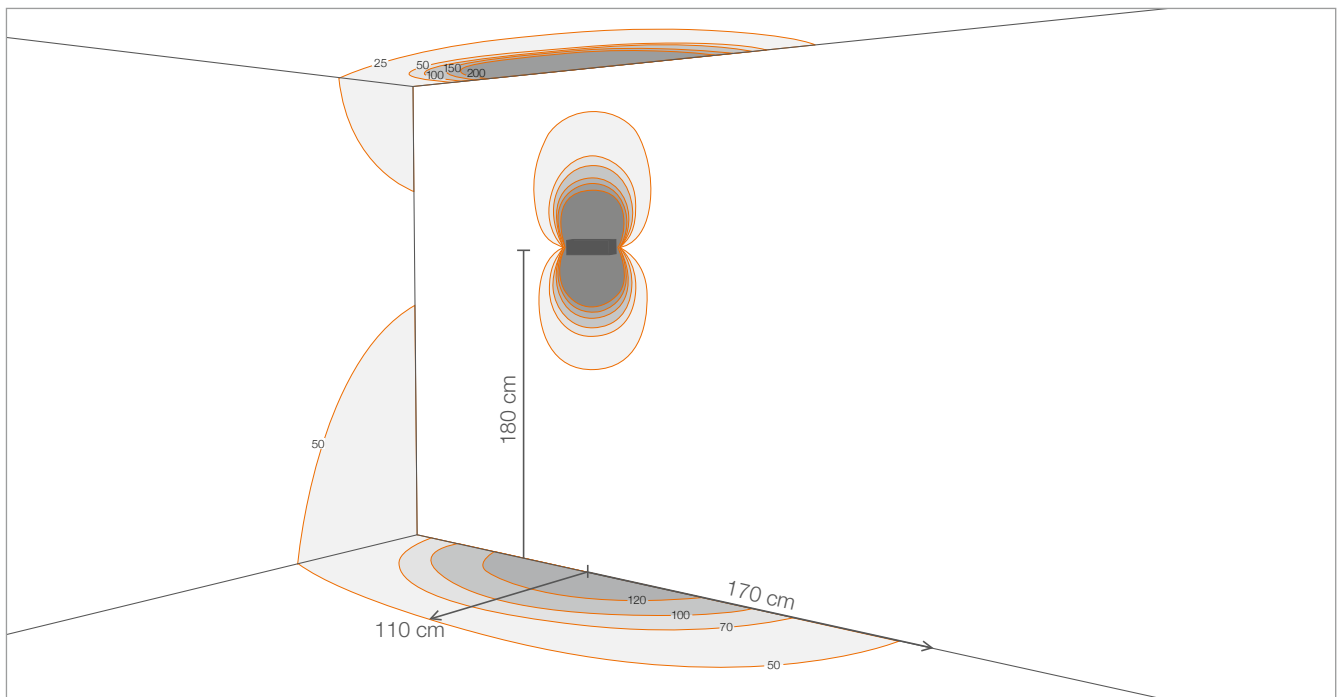

BERICA IN 2.1

Installation in a corridor:
ceiling height: 3 metres
width: 2 metres
average illuminance on the ground: 100 lux

0A - Asymmetrical

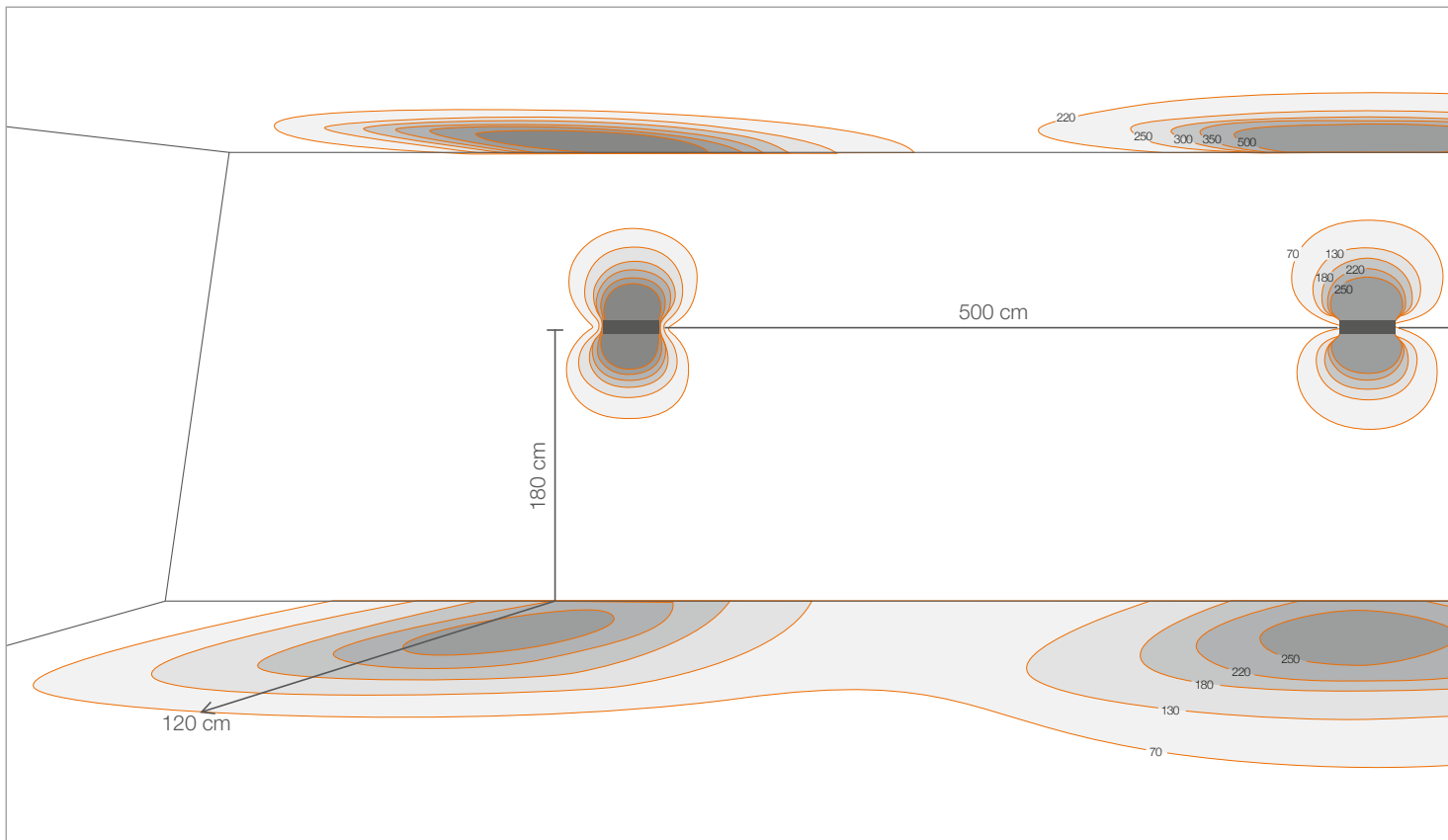

POSITIONING DIAGRAMS

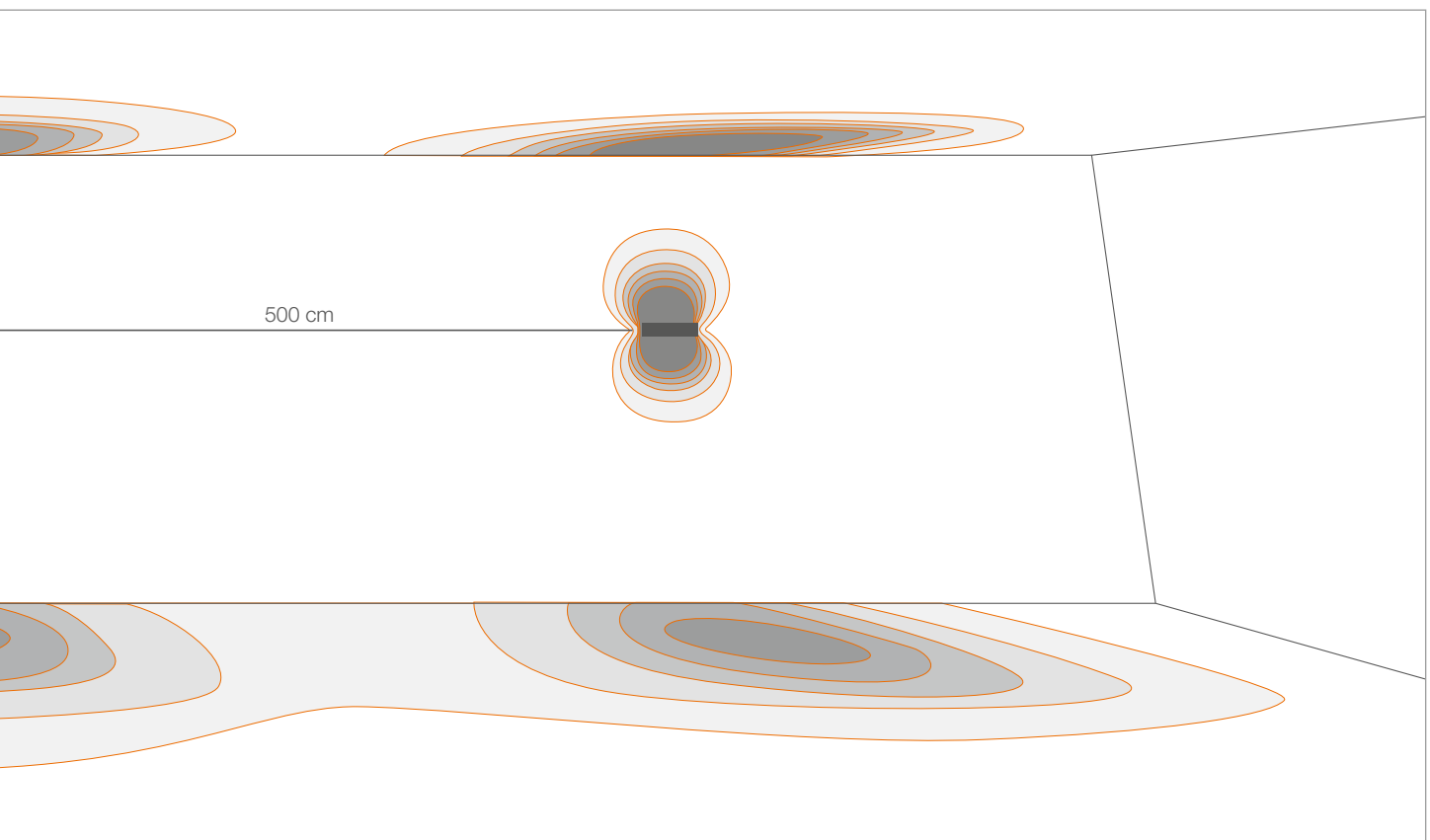



INDOOR WALL MOUNTED SINGLE BEAM, DIFFUSE LIGHT



diffuse



2700K 3000K 4000K

INDOOR

OUTDOOR

WALL MOUNTED



ELLA IN 1.0 p. 624
7W 230Vac
493 lm (3000K)



ELLA IN 2.0 p. 625
13W 230Vac
985 lm (3000K)



ELLA IN 3.0 p. 625
19W 230Vac
1478 lm (3000K)

ELLA OUT p. 350



CEILING MOUNTED **ELLO IN** p. 658

ELLO OUT p. 380

< **ELLA IN 2.0**
3000K, 13W, white

Project by / arch. Fernanda Cantone
Light planning by / Light Style
Castello Tafuri Charming Suites
Portopalo di Capo Passero, Syracuse, Italy

v

ELLA IN 3.0

3000K, 19W, white

ESEM MID 1.0

3000K, 3W, 22°, white, customized IP44 version

Project and light planning by / DVDV Studio Architetti

Photo by / Alessio Tamborini

Private residence, Milan, Italy

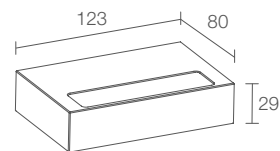

ELLA IN 1.0

CE EAC LED TECH kg 0.40 IP40 IK08
 A A+ A++

POWER / POWER SUPPLY CODE

7W 230Vac
EA1010 DB N White
EA1010 DC N Chrome
EA1010 D 1 N Pure orange
EA1010 D 2 N Reseda green
EA1010 D 3 N Capri blue
EA1010 D 4 N Light ivory

LED COLOUR

F - 2700K
 5 - 3000K
 9 - 4000K

OPTICS

diffuse

LUMEN OUTPUT AT SOURCE 954 lm (3000K)

DELIVERED LUMEN OUTPUT 493 lm (3000K)

NO. AND TYPE OF LED 18 mid-power LEDs
 3-step MacAdam, 50000h L80 B10 (Ta 25°C)

MATERIAL body in aluminium
 screen in serigraphed extra-clear microprismatic glass

POWER SUPPLY UNIT built in

MOUNTING surface mounted (wall)

ACCESSORIES see p. 626 and 627

NOTES outdoor version: Ella OUT 1.0, p. 352
 ceiling-mounted version: Ello IN 1.0, p. 660
 Casambi-compatible version, controllable with the Casambi app, available on request

PHOTOMETRIC DATA see p. 824

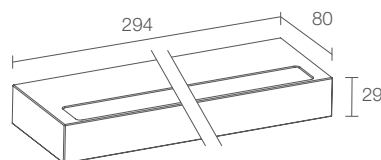
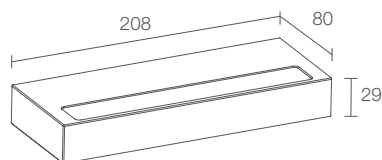

ELLA IN 2.0



CE ENEC LED TEC kg 0.80 IP40 IK08

A A+ A++

13W 230Vac
EA2010 **DB N** White
EA2010 **DC N** Chrome
EA2010 **D 1 N** Pure orange
EA2010 **D 2 N** Reseda green
EA2010 **D 3 N** Capri blue
EA2010 **D 4 N** Light ivory

F - 2700K
 5 - 3000K
 9 - 4000K

diffuse

1908 lm (3000K)

985 lm (3000K)

36 mid-power LEDs
 3-step MacAdam, 50000h L80 B10 (Ta 25°C)

body in aluminium
 screen in serigraphed extra-clear
 microprismatic glass

built in

surface mounted (wall)

see p. 626 and 627

outdoor version: Ella OUT 2.0, p. 353
 ceiling-mounted version: Ello IN 2.0, p. 661
 Casambi-compatible version, controllable with
 the Casambi app, available on request

see p. 824

ELLA IN 3.0

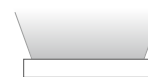

CE ENEC LED TEC kg 1.20 IP40 IK08

A A+ A++

19W 230Vac
EA3010 **DB N** White
EA3010 **DC N** Chrome
EA3010 **D 1 N** Pure orange
EA3010 **D 2 N** Reseda green
EA3010 **D 3 N** Capri blue
EA3010 **D 4 N** Light ivory

F - 2700K
 5 - 3000K
 9 - 4000K

diffuse

2862 lm (3000K)

1478 lm (3000K)

54 mid-power LEDs
 3-step MacAdam, 50000h L80 B10 (Ta 25°C)

body in aluminium
 screen in serigraphed extra-clear
 microprismatic glass

built in

surface mounted (wall)

see p. 626 and 627

outdoor version: Ella OUT 3.0, p. 353
 ceiling-mounted version: Ello IN 3.0, p. 661
 Casambi-compatible version, controllable with
 the Casambi app, available on request

see p. 824

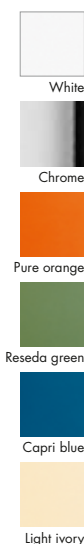

ACCESSORIES FOR INSTALLATION

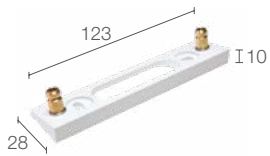

WD0601B - White
WD0601C - Chrome
WD06011 - Pure orange
WD06012 - Reseda green
WD06013 - Capri blue
WD06014 - Light ivory
Spacer for 15° inclination
RAL finish available on request
(Ella IN 1.0)

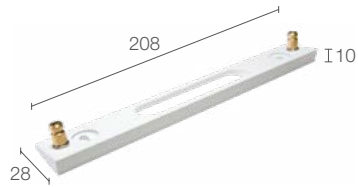

WD0602B - White
WD0602C - Chrome
WD06021 - Pure orange
WD06022 - Reseda green
WD06023 - Capri blue
WD06024 - Light ivory
Spacer for 15° inclination
RAL finish available on request
(Ella IN 2.0)

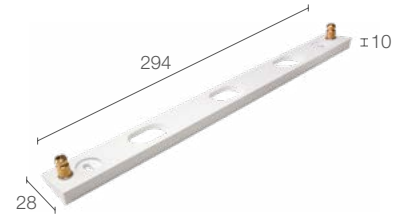

WD0603B - White
WD0603C - Chrome
WD06031 - Pure orange
WD06032 - Reseda green
WD06033 - Capri blue
WD06034 - Light ivory
Spacer for 15° inclination
RAL finish available on request
(Ella IN 3.0)

ACCESSORIES

STANDARD FINISHES



White



Chrome



Pure orange



Reseda green

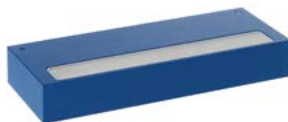

Capri blue



Light ivory

∨
ELLA IN 1.0
without spacer



∨
ELLA IN 1.0
with spacer (15° inclination)





INDOOR WALL MOUNTED DIFFUSE LIGHT, SINGLE OR DOUBLE BEAM

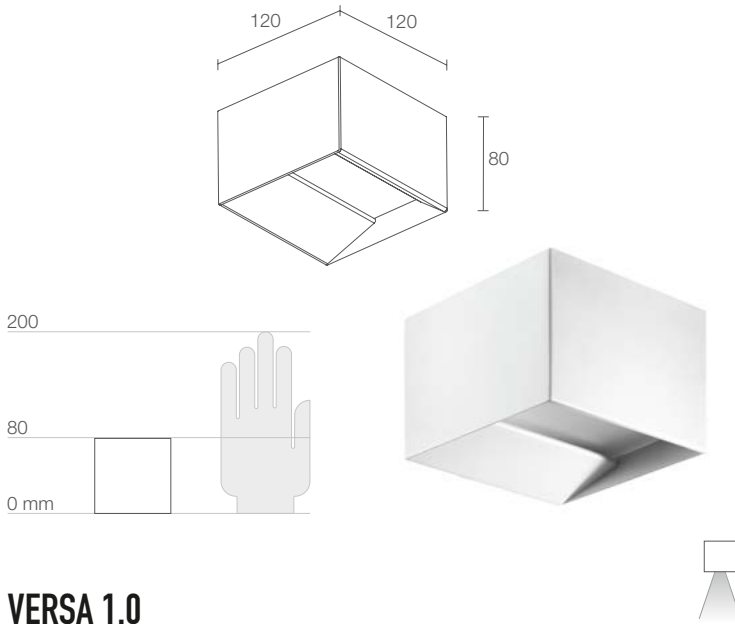

VERSA 1.0

CE ENEC LED TECH kg 0.40 IP40
A A+ A++

POWER / POWER SUPPLY CODE 9W 230Vac
VR1010 D B White

LED COLOUR
F - 2700K
5 - 3000K
9 - 4000K

OPTICS diffuse

LUMEN OUTPUT AT SOURCE 745 lm (3000K)

DELIVERED LUMEN OUTPUT 530 lm (3000K)

NO. AND TYPE OF LED mid-power LED matrix
3-step MacAdam, 50000h L80 B10 (Ta 25°C)

MATERIAL body in steel
screen in one-side-frosted, transparent plexiglass

POWER SUPPLY UNIT built in

POWER CABLES terminal block

MOUNTING surface mounted (wall)

DESIGN BY arch. Enrico Novello

NOTES Casambi-compatible version, controllable with
the Casambi app, available on request

PHOTOMETRIC DATA see p. 899

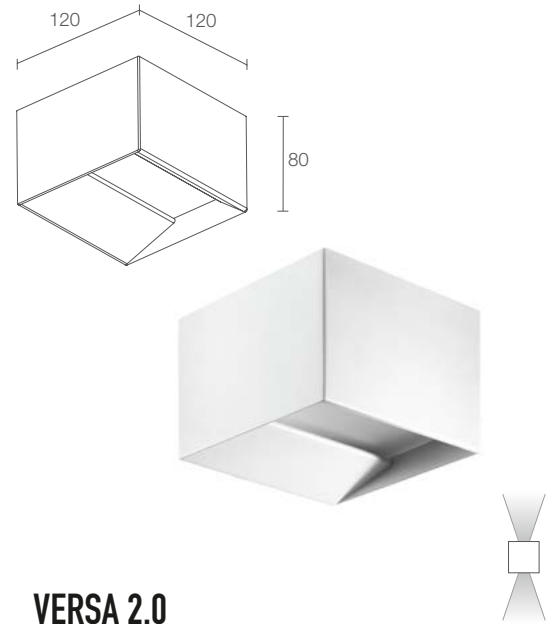

VERSA 2.0

CE ENEC LED TECH kg 0.40 IP40
A A+ A++

18W 230Vac
VR2010 D B White

LED COLOUR
F - 2700K
5 - 3000K
9 - 4000K

OPTICS diffuse

LUMEN OUTPUT AT SOURCE 1646 lm (3000K)

DELIVERED LUMEN OUTPUT 1170 lm (3000K)

NO. AND TYPE OF LED mid-power LED matrix
3-step MacAdam, 50000h L80 B10 (Ta 25°C)

MATERIAL body in steel
screen in one-side-frosted, transparent plexiglass

POWER SUPPLY UNIT built in

POWER CABLES terminal block

MOUNTING surface mounted (wall)

DESIGN BY arch. Enrico Novello

NOTES Casambi-compatible version, controllable with
the Casambi app, available on request

PHOTOMETRIC DATA see p. 899



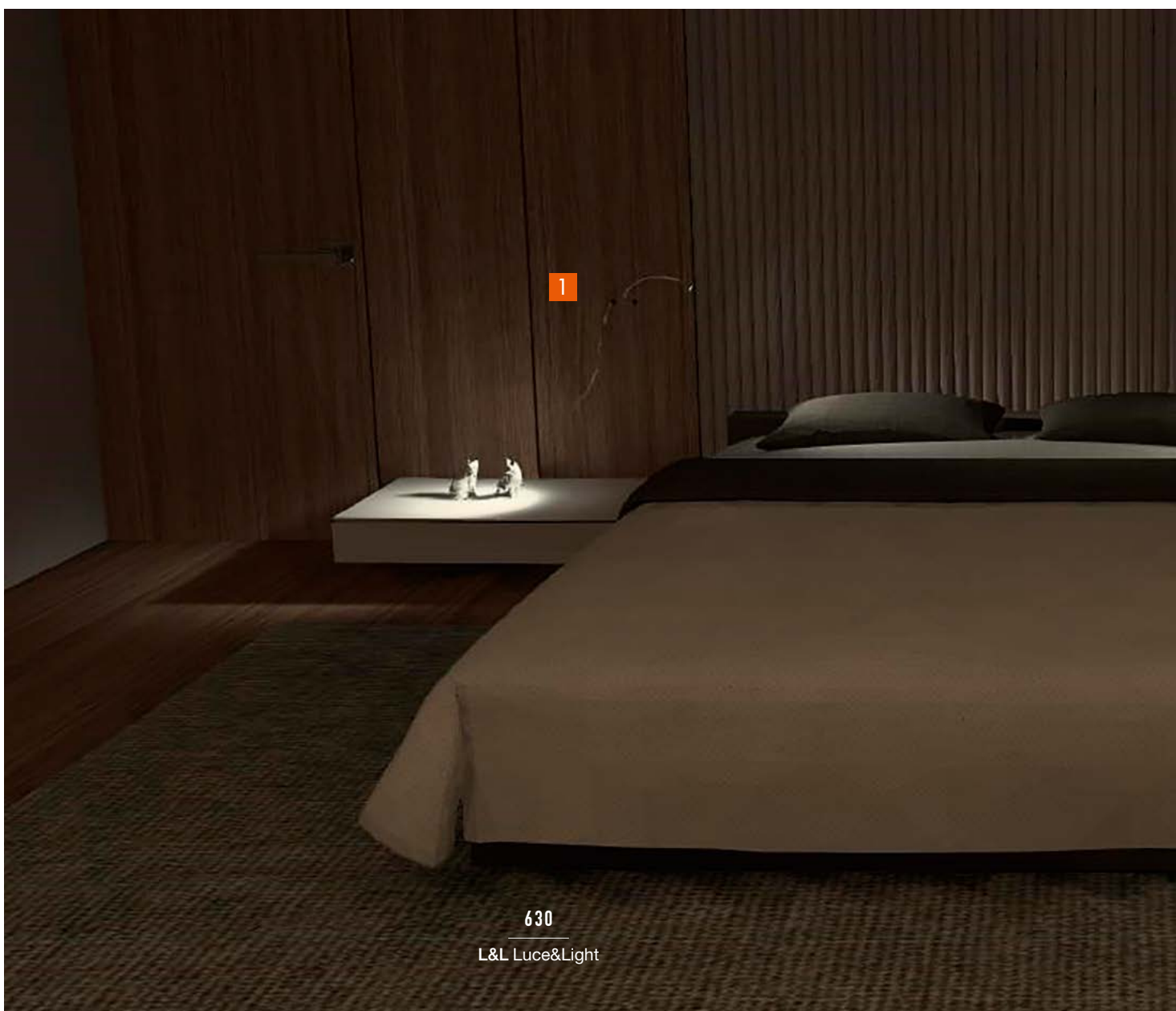



READING LAMPS

WALL p. 632 **1**

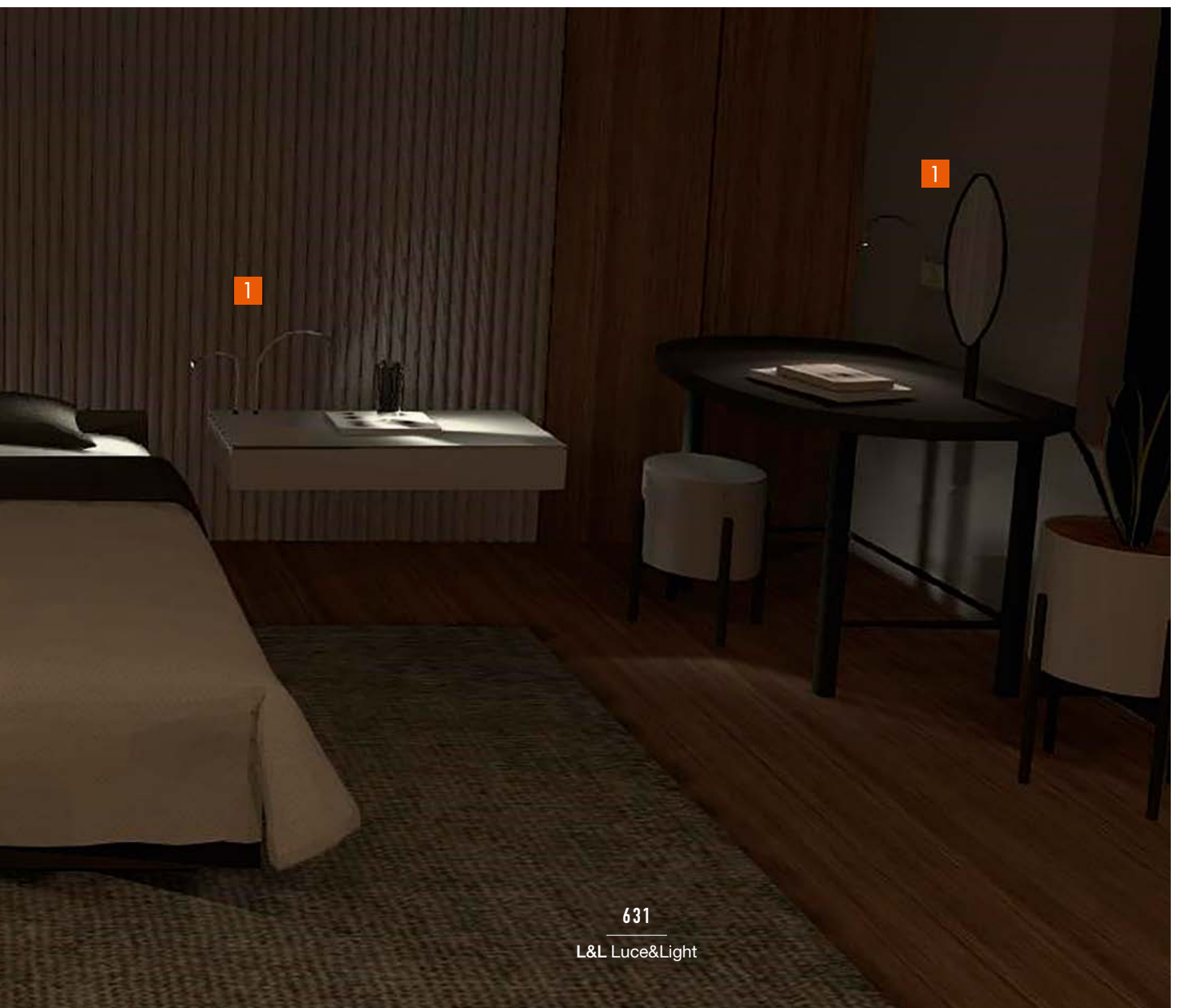





READING LAMPS FOR HOSPITALITY AND PRIVATE HOMES



**WALL
MOUNTED**



**MOUNTED ON
A SPARE GANG**



**MOUNTED ON
A SHELF**

ZOOM LENS

3000K 5000K



zoom lens



WALL 1 p. 634
2.5W 230Vac
3.5W 230Vac



WALL 3 p. 635
2.5W 230Vac
3.5W 230Vac

OPTICS VERSION

2700K 3000K 4000K 5000K



narrow medium wide



WALL 8.1 p. 637
2.5W 230Vac
3.5W 230Vac



WALL 8.0 p. 636
max 2W max 500mA



WALL 8.2 p. 637
2.5W 230Vac
3.5W 230Vac

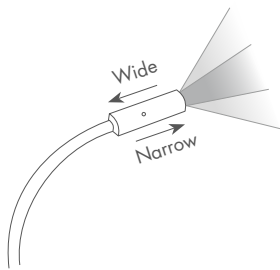

Adjustable beam



Flexible neck:
 Ø6 mm - 400 mm
 Ø8 mm - 400/500 mm



Standard version:
 bottom cable entry

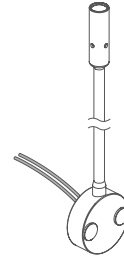

Available on request:
 rear cable entry



WALL 1

kg 0.30 400 mm Ø6 mm
 kg 0.32 400 mm Ø8 mm
 kg 0.33 500 mm Ø8 mm

IP20

A A+ A++

POWER / POWER SUPPLY CODE

2.5W 230Vac	400 mm	Neck Ø6 mm
L11640	C	Chrome
L11640	D	Gold
L11640	S	Satin
3.5W 230Vac	400 mm	Neck Ø6 mm
L12640	C	Chrome
L12640	D	Gold
L12640	S	Satin
2.5W 230Vac	400 mm	Neck Ø8 mm
L11840	C	Chrome
L11840	D	Gold
L11840	S	Satin
3.5W 230Vac	400 mm	Neck Ø8 mm
L12840	C	Chrome
L12840	D	Gold
L12840	S	Satin
2.5W 230Vac	500 mm	Neck Ø8 mm
L11850	C	Chrome
L11850	D	Gold
L11850	S	Satin
3.5W 230Vac	500 mm	Neck Ø8 mm
L12850	C	Chrome
L12850	D	Gold
L12850	S	Satin

LED COLOUR

5 - 3000K
0 - 5000K

OPTICS

optical range 20–55°

LUMEN OUTPUT AT SOURCE	145 lm (3000K, 3.5W)
DELIVERED LUMEN OUTPUT	61 lm (3000K, 3.5W)
NO. AND TYPE OF LEDS	1 power LED 1/4 ANSI BIN, 50000h L90 B10 (T _a 25°C)
MATERIAL	body in aluminium, neck in brass
POWER SUPPLY UNIT	power supply unit built into plug with switch on cable
POWER CABLES	includes 1.5 m cable, with built-in plug and PSU
MOUNTING	surface mounted (wall)
NOTES	version with rear cable entry available on request Casambi-compatible version, controllable with the Casambi app, available on request
PHOTOMETRIC DATA	see p. 900



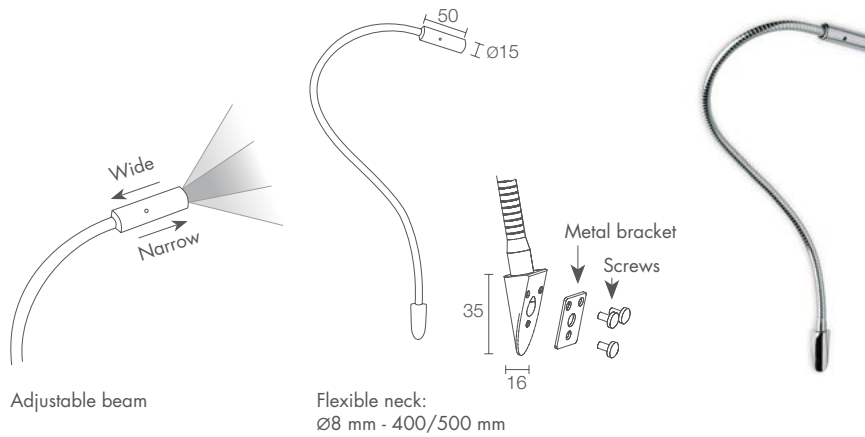

Adjustable beam

Flexible neck:
Ø8 mm - 400/500 mm

WALL 3

kg 0.19 400 mm IP20
 kg 0.29 500 mm
A A+ A++

POWER / POWER SUPPLY CODE

2.5W 230Vac 400 mm Neck Ø8 mm
PL11840 C Chrome
PL11840 D Gold
PL11840 S Satin
3.5W 230Vac 400 mm Neck Ø8 mm
PL12840 C Chrome
PL12840 D Gold
PL12840 S Satin
2.5W 230Vac 500 mm Neck Ø8 mm
PL11850 C Chrome
PL11850 D Gold
PL11850 S Satin
3.5W 230Vac 500 mm Neck Ø8 mm
PL12850 C Chrome
PL12850 D Gold
PL12850 S Satin

LED COLOUR

5 - 3000K
0 - 5000K

OPTICS

optical range 20–55°

LUMEN OUTPUT AT SOURCE	145 lm (3000K, 3.5W)
DELIVERED LUMEN OUTPUT	61 lm (3000K, 3.5W)
NO. AND TYPE OF LEDS	1 power LED 1/4 ANSI BIN, 50000h L90 B10 (Ta 25°C)
MATERIAL	body in aluminium, neck in brass
POWER SUPPLY UNIT	included
POWER CABLES	includes 0.30 m two-core cable
MOUNTING	on a spare gang
NOTES	Casambi-compatible version, controllable with the Casambi app, available on request
PHOTOMETRIC DATA	see p. 900



✓
WALL 1
 3000K, 2.5W, satin, customized version
 with rear cable entry

Private collection, Milan, Italy
 Courtesy of / Susanna Roda



Flexible neck:
 Ø8 mm - 400 mm



WALL 8.0

CE ENEC LED TECH III kg 0.16 IP40

A A+ A++

POWER / POWER SUPPLY CODE

max 2W max 500mA 400 mm
PL801240 ■ C Chrome
PL801240 ■ S Satin

LED COLOUR

F - 2700K
5 - 3000K
9 - 4000K
0 - 5000K

OPTICS

S - 10°
M - 25°
L - 40°

LUMEN OUTPUT AT SOURCE	145 lm (3000K, 500mA)
DELIVERED LUMEN OUTPUT	103 lm (3000K, 500mA, 25°)
NO. AND TYPE OF LEDS	1 power LED 1/4 ANSI BIN, 50000h L90 B10 (Ta 25°C)
MATERIAL	body in aluminium, neck in brass
POWER SUPPLY UNIT	not included, see p. 904
POWER CABLES	includes 0.50 m PVC cable FROR 2x0.35 Ø3.5 mm
WIRING	series
MOUNTING	surface mounted (shelf max 30 mm)
ACCESSORIES	see p. 639
NOTES	Casambi-compatible version, controllable with the Casambi app, available on request
PHOTOMETRIC DATA	see p. 900



Flexible neck:
Ø8 mm - 400 mm

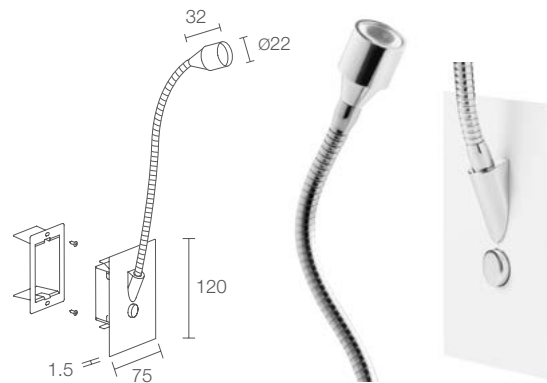

Flexible neck:
Ø8 mm - 400 mm

Chrome finish: white plate
Satin finish: satin plate

WALL 8.1

CE ENEC LED TECH kg 0.34 IP20

A A+ A++

2.5W 230Vac 400 mm
PL811140 C Chrome
PL811140 S Satin

3.5W 230Vac 400 mm
PL811240 C Chrome
PL811240 S Satin

F - 2700K
 5 - 3000K
 9 - 4000K
 0 - 5000K

S - 10°
 M - 25°
 L - 40°

145 lm (3000K, 3.5W)

103 lm (3000K, 25°, 3.5W)

1 power LED
 1/4 ANSI BIN, 50000h L90 B10 (Ta 25°C)

body in aluminium, neck in brass
 base in steel

built in with switch on base of neck

none

mains voltage

surface mounted (wall)

none

Casambi-compatible version, controllable with
 the Casambi app, available on request

see p. 900

WALL 8.2

CE ENEC LED TECH kg 0.37 IP20

A A+ A++

2.5W 230Vac 400 mm
PL821140 C Chrome
PL821140 S Satin

3.5W 230Vac 400 mm
PL821240 C Chrome
PL821240 S Satin

F - 2700K
 5 - 3000K
 9 - 4000K
 0 - 5000K

S - 10°
 M - 25°
 L - 40°

145 lm (3000K, 3.5W)

103 lm (3000K, 25°, 3.5W)

1 power LED
 1/4 ANSI BIN, 50000h L90 B10 (Ta 25°C)

body in aluminium, neck in brass
 plate in steel

built in with switch on base of neck

includes 0.30 m two-core cable

mains voltage

surface mounted (wall)

see p. 639

Casambi-compatible version, controllable with
 the Casambi app, available on request

see p. 900

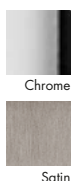





ACCESSORIES

ACCESSORIES FOR INSTALLATION



WC0301

Optional outer casing
(Wall 8.2)

POWER CABLES

PVC cable
FROR 2x0.35 Ø3.5 mm
your choice of length

WF0110

(Wall 8.0)

order together with the lighting fixture



CEILING MOUNTED FOR INDOOR APPLICATIONS

INTONO C IN p. 644 **1**

BITPOP C p. 650 **2**

TEKO p. 654 **3**

ELLO IN p. 658 **4**

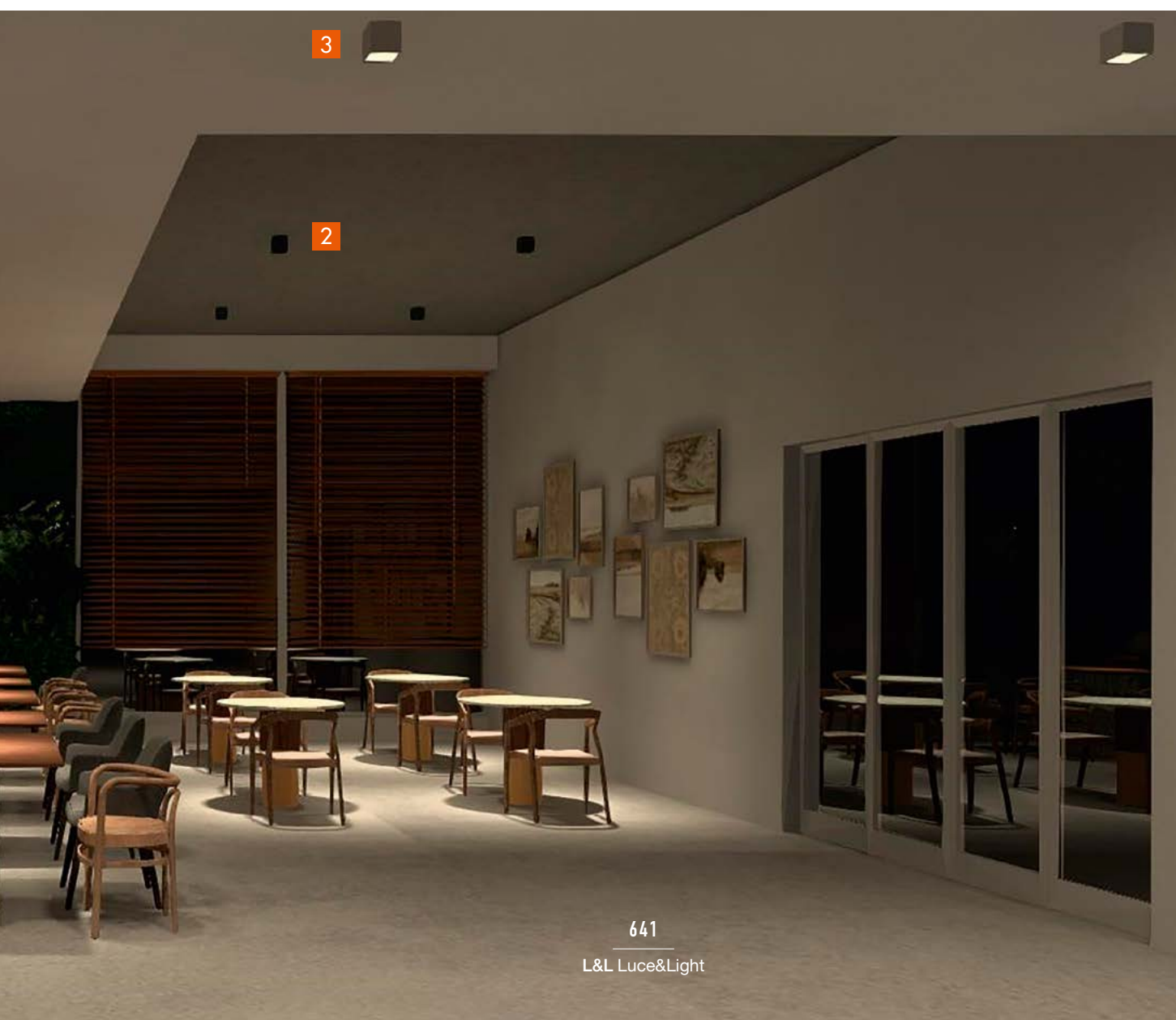

	BEAM	LIGHT COLOUR	POWER SUPPLY
INTONO C IN see p. 644  HOSPITALITY AND PRIVATE HOMES	DIFFUSE VERSION OPTICS VERSION	 2700K 3000K 4000K	CONSTANT VOLTAGE (power supply unit not included) 24Vdc MAINS VOLTAGE (built-in power supply unit) 230Vac
BITPOP C see p. 650  RETAIL, OFFICES AND WORKPLACES	OPTICS VERSION	 2700K 3000K 4000K	CONSTANT VOLTAGE (power supply unit not included) 24Vdc MAINS VOLTAGE (built-in power supply unit) 230Vac
TEKO see p. 654  CORRIDORS AND HALLWAYS	DIFFUSE VERSION	 2700K 3000K 4000K	MAINS VOLTAGE (built-in power supply unit) 230Vac
ELLO IN see p. 658  CORRIDORS AND HALLWAYS	DIFFUSE VERSION	 2700K 3000K 4000K	MAINS VOLTAGE (built-in power supply unit) 230Vac

CEILING MOUNTED FOR INDOOR APPLICATIONS

IP	APPLIANCE CLASS	UNIQUE SELLING POINTS
IP40	 	version with primer version with speaker
IP40	 	UGR < 10 for 17° and 30° optics
IP40		
IP40		



644

L&L Luce&Light

INTONO C IN

INDOOR CEILING MOUNTED WITH LIGHT OUTPUT ALONE OR ALSO WITH SPEAKER FOR PRIVATE HOMES AND HOSPITALITY

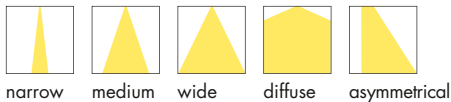

INDOOR

OUTDOOR

CEILING MOUNTED



INTONO C IN 2.3 p. 646
12W 230Vac
ON/OFF

INTONO C OUT p. 374



INTONO C IN 3.3 p. 647
20W 230Vac
ON/OFF, DALI, 0/1-10V

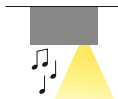

INTONO C IN 3.8 p. 647
9W 24Vdc

WALL MOUNTED

INTONO p. 324



^
INTONO C IN 3.8

speaker:
maximum power
nominal impedance Z
mean sound pressure level

3W
16 Ohm
86 dB (1W/1m)

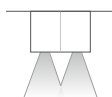

INTONO C IN 2.3

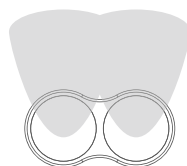
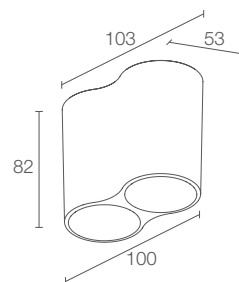

Asymmetrical optics
(Intono C IN 3.3)

v
INTONO C IN 3.3

painting primer version



CE LED TECH IP40 IK06
A A+ A++

POWER / POWER SUPPLY CODE

12W 230Vac
NC2310 00 **B** White
NC2310 00 **N** Black
NC2310 00 **Z** Antique bronze
NC2310 00 **7** Primer

CRI
0 - CRI 80
1 - CRI >90

CONTROL SYSTEM on/off

HONEYCOMB LOUVRE
0 - not present
1 - present
 (not compatible with the diffuse optics)

LED COLOUR
F - 2700K
5 - 3000K
9 - 4000K

OPTICS
TT - 11°
MM - 34°
KK - 68°
DD - diffuse

LUMEN OUTPUT AT SOURCE	976 lm (3000K, CRI 80)
DELIVERED LUMEN OUTPUT	704 lm (3000K, 34°, CRI 80)
NO. AND TYPE OF LED	2 power LEDs 3-step MacAdam, 50000h L90 B10 (Ta 25°C)
MATERIAL	body in die-cast aluminium screen in black-serigraphed and transparent, tempered extra-clear glass
POWER SUPPLY UNIT	built in
MOUNTING	surface mounted (ceiling)
ACCESSORIES	none
FEATURES	easy installation thanks to 4-point magnetic fastener
NOTES	outdoor version: Intono C OUT 2.4 p. 376 wall-mounted version: Intono p. 324 version compatible with Google Home or Amazon Echo available on request for voice command control Casambi-compatible version, controllable with the Casambi app, available on request
PHOTOMETRIC DATA	see p. 839

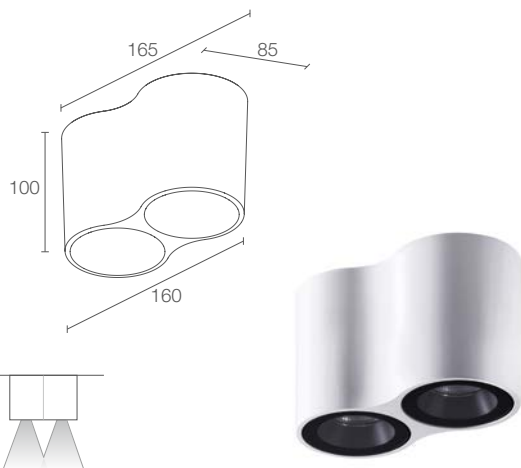

INTONO C IN 3.3

CE kg 1.15 IP40 IK06 DALI 0/1-10V

20W 230Vac

NC3310 **0** **B** White
NC3310 **0** **N** Black
NC3310 **0** **Z** Antique bronze
NC3310 **0** **7** Primer

0 - CRI 80
1 - CRI >90

0 - on/off
D - DALI
R - 0/1-10V

0 - not present
1 - present
 (not compatible with the asymmetrical optics)

F - 2700K
5 - 3000K
9 - 4000K

SS - 15°
MM - 20°
LL - 43°
AA - asymmetrical

1976 lm (3000K, CRI 80)

1674 lm (3000K, 15°, CRI 80)

2 high power density COB LEDs
 2-step MacAdam, 50000h L95 B10 (Ta 25°C)

body in die-cast aluminium
 screen in black-serigraphed and transparent,
 tempered extra-clear glass

built in

surface mounted (ceiling)

none

easy installation thanks to 4-point
 magnetic fastener

outdoor version: Intono C OUT 3.4 p. 377
 wall-mounted version: Intono p. 324
 version compatible with Google Home
 or Amazon Echo available on request
 for voice command control
 Casambi-compatible version, controllable with
 the Casambi app, available on request

see p. 839

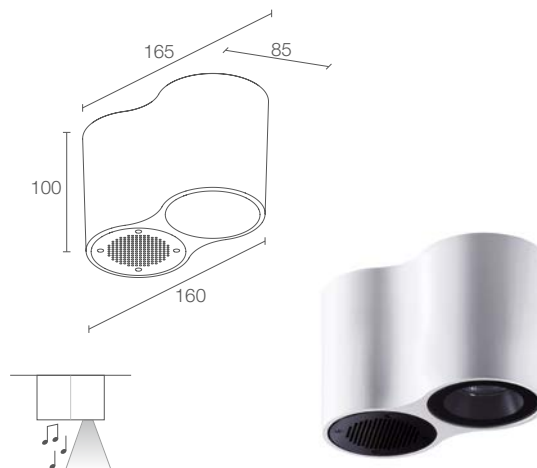

INTONO C IN 3.8

CE kg 1.15 IP40 IK06

9W 24Vdc

NC3800 **00** **M9 B** White
NC3800 **00** **M9 N** Black
NC3800 **00** **M9 Z** Antique bronze
NC3800 **00** **M9 7** Primer

0 - CRI 80
1 - CRI >90

0 - not present
1 - present

F - 2700K
5 - 3000K
9 - 4000K

20°

988 lm (3000K, CRI 80)

783 lm (3000K, 20°, CRI 80)

1 high power density COB LED
 2-step MacAdam, 50000h L95 B10 (Ta 25°C)

body in die-cast aluminium
 screen in black-serigraphed and transparent,
 tempered extra-clear glass

not included, see p. 904

surface mounted (ceiling)

see p. 649

easy installation thanks to 4-point
 magnetic fastener

outdoor version: Intono C OUT 3.9 p. 377
 wall-mounted version: Intono p. 324
 version compatible with Google Home
 or Amazon Echo available on request
 for voice command control
 Casambi-compatible version, controllable with
 the Casambi app, available on request

see p. 839

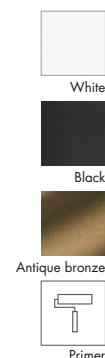



ACCESSORIES

ACCESSORIES



WUNT39A00

Bluetooth 3.0 audio control kit with power supply unit and amplifier (for Alexa or Google voice-control systems)
(Intono C IN 3.8)



WUNT39A01

Wi-Fi light control kit
(Intono C IN 3.8)

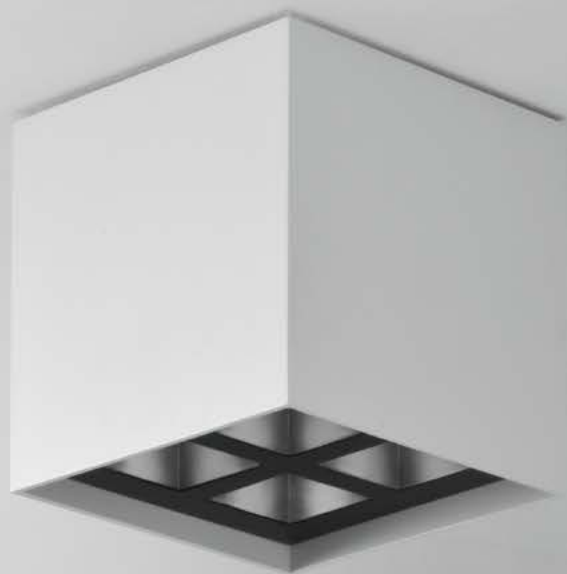

INDOOR CEILING MOUNTED FOR OFFICES AND WORK SPACES

2700K 3000K 4000K



1 OPTICS UNIT



**4 OPTICS
IN A SQUARE**



**4 OPTICS
IN A LINE**

CEILING MOUNTED

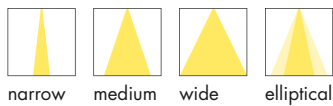

narrow medium wide elliptical



BITPOP C 1.0 p. 652
6.5W 24Vdc
ON/OFF



BITPOP C 2.2 p. 653
18W 230Vac
ON/OFF, DALI, 0/1-10V



BITPOP C 4.1 p. 653
18W 230Vac
ON/OFF, DALI, 0/1-10V

RECESSED

BITPOP p. 530

✓
BITPOP C 1.0
 4000K, 6.5W, 17°, black

Project by / Studio Carella + Salvato
 Executed by / ing. Giuseppe Occulto
 Photo by / Alessio Tamborini
 LEX law firm, Foggia, Italy

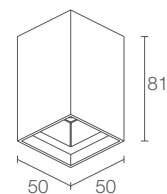
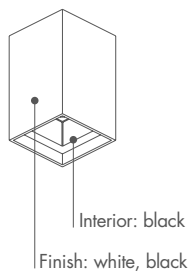

BITPOP C 1.0

CE CB ENEC LED TECH III kg 0.30 IP40

A A+ A++

POWER / POWER SUPPLY CODE

6.5W 24Vdc
BC1000 ■ ■ **B 0** White - Black
BC1000 ■ ■ **N 0** Black - Black

LED COLOUR

1F - 2700K CRI >90
15 - 3000K CRI >90
09 - 4000K CRI 80

OPTICS

S - 17°
F - 30°
L - 42°
W - 17°x45°

CONTROL SYSTEM

LUMEN OUTPUT AT SOURCE	480 lm (3000K)
DELIVERED LUMEN OUTPUT	335 lm (3000K, 30°)
NO. AND TYPE OF LED	1 high-intensity power LED 3-step MacAdam, 50000h L85 B10 (Ta 25°C)
MATERIAL	body in aluminium trim in steel
POWER SUPPLY UNIT	not included, see p. 904
POWER CABLES	includes 1.5 m PVC cable FROR 2x0.35 Ø3.5 mm
MOUNTING	surface mounted (ceiling)
FEATURES	UGR < 10 for the 17° and 30° optics
NOTES	recessed version: Bitpop 1.0, p. 532 Casambi-compatible version, controllable with the Casambi app, available on request
PHOTOMETRIC DATA	see p. 793

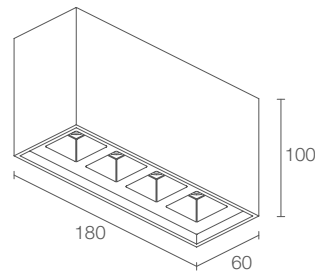
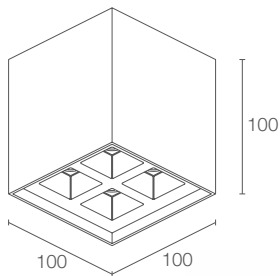

17°x45° optics

BITPOP C 2.2

CE CB ENEC LED TECH kg 0.70 IP40
 DALI PUSH 0/1-10V

18W 230Vac

BC2210 White - Black
BC2210 Black - Black

1F - 2700K CRI >90
15 - 3000K CRI >90
09 - 4000K CRI 80

S - 17°
F - 30°
L - 42°
W - 17°x45°

O - on/off
R - 0/1-10V + PUSH
D - DALI

1400 lm (3000K)

992 lm (3000K, 30°)

4 high-intensity power LEDs
 3-step MacAdam, 50000h L85 B10 (Ta 25°C)

body in aluminium
 trim in steel

included and wired

includes 0.30 m cable

surface mounted (ceiling)

UGR < 10 for the 17° and 30° optics

recessed version: Bitpop 2.2, p. 533
 Casambi-compatible version, controllable with
 the Casambi app, available on request

see p. 793

BITPOP C 4.1

CE CB ENEC LED TECH kg 0.70 IP40
 DALI PUSH 0/1-10V

18W 230Vac

BC4110 White - Black
BC4110 Black - Black

1F - 2700K CRI >90
15 - 3000K CRI >90
09 - 4000K CRI 80

S - 17°
F - 30°
L - 42°
W - 17°x45°

O - on/off
R - 0/1-10V
D - DALI + PUSH

1400 lm (3000K)

992 lm (3000K, 30°)

4 high-intensity power LEDs
 3-step MacAdam, 50000h L85 B10 (Ta 25°C)

body in aluminium
 trim in steel

included and wired

includes 0.30 m cable

surface mounted (ceiling)

UGR < 10 for the 17° and 30° optics

recessed version: Bitpop 4.1, p. 534
 Casambi-compatible version, controllable with
 the Casambi app, available on request

see p. 793

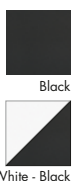



INDOOR CEILING MOUNTED WITH DIFFUSE LIGHT

2700K 3000K 4000K



diffuse

SQUARE

80x80 mm



TEKO 5.0 p. 656
5W 230Vac
9W 230Vac

100x100 mm



TEKO 7.0 p. 657
9W 230Vac
17W 230Vac

ROUND

Ø80 mm



TEKO 5.1 p. 656
5W 230Vac
9W 230Vac

Ø100 mm



TEKO 7.1 p. 657
9W 230Vac

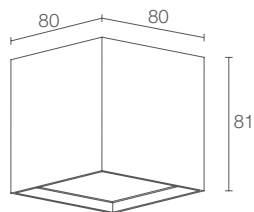

TEKO 5.0



POWER / POWER SUPPLY CODE

5W 230Vac
TK5010 ■ D B White

9W 230Vac
TK5011 ■ D B White

LED COLOUR

F - 2700K
5 - 3000K
9 - 4000K

OPTICS

diffuse

LUMEN OUTPUT AT SOURCE
 460 lm (3000K, 5W)
 826 lm (3000K, 9W)

DELIVERED LUMEN OUTPUT
 330 lm (3000K, 5W)
 590 lm (3000K, 9W)

NO. AND TYPE OF LED
 power LED matrix
 3-step MacAdam, 50000h L80 B10 (Ta 25°C)

MATERIAL
 body in anodized aluminium
 screen in one-side-frosted, transparent plexiglass

POWER SUPPLY UNIT
 built in

POWER CABLES
 terminal block

MOUNTING
 surface mounted (ceiling)

NOTES
 Casambi-compatible version, controllable with the Casambi app, available on request

PHOTOMETRIC DATA
 see p. 894

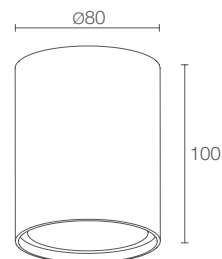

TEKO 5.1



5W 230Vac
TK5110 ■ D B White

9W 230Vac
TK5111 ■ D B White

F - 2700K
5 - 3000K
9 - 4000K

diffuse

LUMEN OUTPUT AT SOURCE
 534 lm (3000K, 5W)
 958 lm (3000K, 9W)

DELIVERED LUMEN OUTPUT
 382 lm (3000K, 5W)
 684 lm (3000K, 9W)

NO. AND TYPE OF LED
 power LED matrix
 3-step MacAdam, 50000h L80 B10 (Ta 25°C)

MATERIAL
 body in anodized aluminium
 screen in one-side-frosted, transparent plexiglass

POWER SUPPLY UNIT
 built in

POWER CABLES
 terminal block

MOUNTING
 surface mounted (ceiling)

NOTES
 Casambi-compatible version, controllable with the Casambi app, available on request

PHOTOMETRIC DATA
 see p. 894

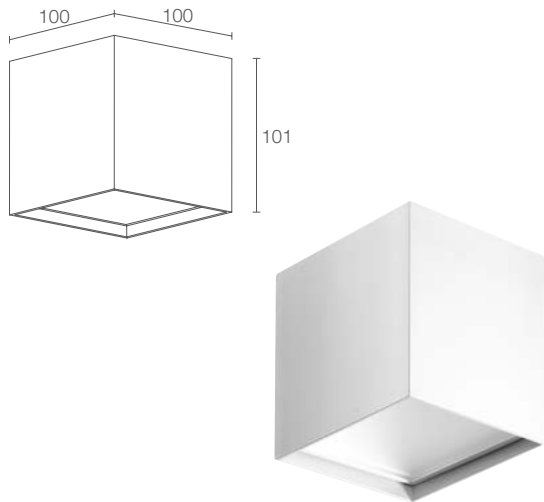

TEKO 7.0

CE EAC LED TECH kg 0.60 IP40
 A A+ A++

9W 230Vac
TK7010 ■ D B White

17W 230Vac
TK7011 ■ D B White

■ F - 2700K
 5 - 3000K
 9 - 4000K

diffuse

826 lm (3000K, 9W)
 1565 lm (3000K, 17W)

590 lm (3000K, 9W)
 1119 lm (3000K, 17W)

power LED matrix
 3-step MacAdam, 50000h L80 B10 (Ta 25°C)

body in anodized aluminium
 screen in one-side-frosted, transparent plexiglass

built in

terminal block

surface mounted (ceiling)

Casambi-compatible version, controllable with the Casambi app, available on request

see p. 894

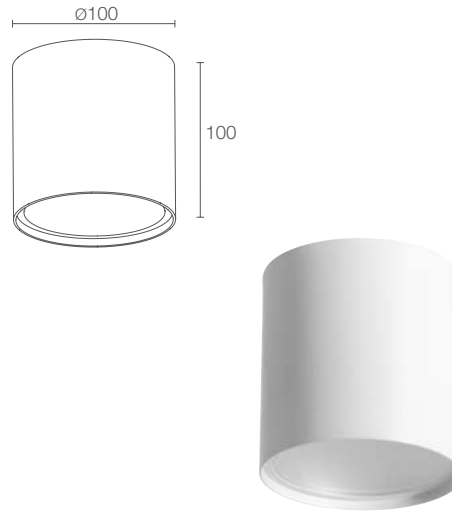

TEKO 7.1

CE EAC LED TECH kg 0.76 IP40
 A A+ A++

9W 230Vac
TK7110 ■ D B White

■ F - 2700K
 5 - 3000K
 9 - 4000K

diffuse

958 lm (3000K)

684 lm (3000K)

power LED matrix
 3-step MacAdam, 50000h L80 B10 (Ta 25°C)

body in anodized aluminium
 screen in one-side-frosted, transparent plexiglass

built in

terminal block

surface mounted (ceiling)

Casambi-compatible version, controllable with the Casambi app, available on request

see p. 894





INDOOR CEILING MOUNTED WITH DIFFUSE LIGHT



diffuse



2700K 3000K 4000K

INDOOR

OUTDOOR

CEILING MOUNTED

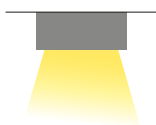

ELLO IN 1.0 p. 660
7W 230Vac
493 lm (3000K)



ELLO IN 2.0 p. 661
13W 230Vac
985 lm (3000K)



ELLO IN 3.0 p. 661
19W 230Vac
1478 lm (3000K)

ELLO OUT p. 380

WALL MOUNTED

ELLA IN p. 622

ELLA OUT p. 350

✓
ELLO IN 2.0
 3000K, 13W, white

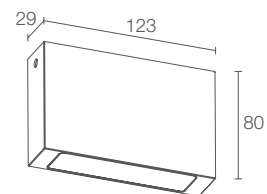

ELLO IN 1.0

CE ENEC LED TECH kg 0.40 IP40 IK08
 A A+ A++

POWER / POWER SUPPLY CODE

7W 230Vac
EP1010 **DB N** White
EP1010 **DC N** Chrome
EP1010 **D 1 N** Pure orange
EP1010 **D 2 N** Reseda green
EP1010 **D 3 N** Capri blue
EP1010 **D 4 N** Light ivory

LED COLOUR

F - 2700K
5 - 3000K
9 - 4000K

OPTICS

diffuse

LUMEN OUTPUT AT SOURCE 954 lm (3000K)

DELIVERED LUMEN OUTPUT 493 lm (3000K)

NO. AND TYPE OF LED 18 mid-power LEDs
 3-step MacAdam, 50000h L80 B10 (Ta 25°C)

MATERIAL body in aluminium
 screen in serigraphed extra-clear microprismatic glass

POWER SUPPLY UNIT built in

MOUNTING surface mounted (ceiling)

ACCESSORIES see p. 663

NOTES outdoor version: Ello OUT 1.0, p. 382
 wall-mounted version: Ella IN 1.0, p. 624
 Casambi-compatible version, controllable with the Casambi app, available on request

PHOTOMETRIC DATA see p. 825

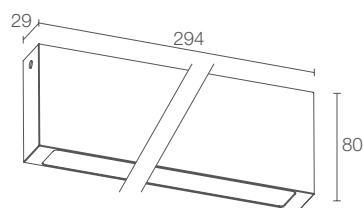
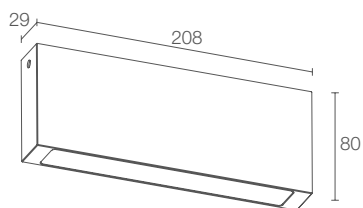

ELLO IN 2.0

CE ENEC LED TECH kg 0.80 IP40 IK08
 A A+ A++

13W 230Vac

- EP2010** **D B N** White
- EP2010** **D C N** Chrome
- EP2010** **D 1 N** Pure orange
- EP2010** **D 2 N** Reseda green
- EP2010** **D 3 N** Capri blue
- EP2010** **D 4 N** Light ivory

- F** - 2700K
- 5** - 3000K
- 9** - 4000K

diffuse

1908 lm (3000K)

985 lm (3000K)

36 mid-power LEDs
 3-step MacAdam, 50000h L80 B10 (Ta 25°C)

body in aluminium
 screen in serigraphed extra-clear microprismatic glass

built in

surface mounted (ceiling)

see p. 663

outdoor version: Ello OUT 2.0, p. 383
 wall-mounted version: Ella IN 2.0, p. 625
 Casambi-compatible version, controllable with
 the Casambi app, available on request

see p. 825

ELLO IN 3.0

CE ENEC LED TECH kg 1.20 IP40 IK08
 A A+ A++

19W 230Vac

- EP3010** **D B N** White
- EP3010** **D C N** Chrome
- EP3010** **D 1 N** Pure orange
- EP3010** **D 2 N** Reseda green
- EP3010** **D 3 N** Capri blue
- EP3010** **D 4 N** Light ivory

- F** - 2700K
- 5** - 3000K
- 9** - 4000K

diffuse

2862 lm (3000K)

1478 lm (3000K)

54 mid-power LEDs
 3-step MacAdam, 50000h L80 B10 (Ta 25°C)

body in aluminium
 screen in serigraphed extra-clear microprismatic glass

built in

surface mounted (ceiling)

see p. 663

outdoor version: Ello OUT 3.0, p. 383
 wall-mounted version: Ella IN 3.0, p. 625
 Casambi-compatible version, controllable with
 the Casambi app, available on request

see p. 825





ACCESSORIES

ACCESSORIES FOR INSTALLATION

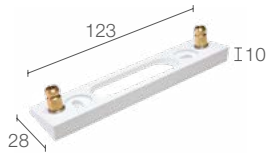

WD0601B - White
WD0601C - Chrome
WD06011 - Pure orange
WD06012 - Reseda green
WD06013 - Capri blue
WD06014 - Light ivory
 Spacer for 15° inclination
 RAL finish available on request
 (Ello IN 1.0)

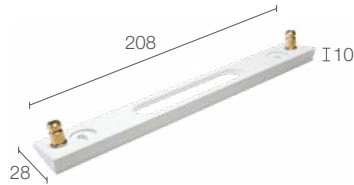

WD0602B - White
WD0602C - Chrome
WD06021 - Pure orange
WD06022 - Reseda green
WD06023 - Capri blue
WD06024 - Light ivory
 Spacer for 15° inclination
 RAL finish available on request
 (Ello IN 2.0)

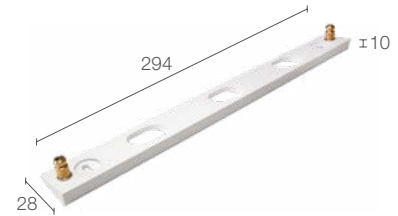

WD0603B - White
WD0603C - Chrome
WD06031 - Pure orange
WD06032 - Reseda green
WD06033 - Capri blue
WD06034 - Light ivory
 Spacer for 15° inclination
 RAL finish available on request
 (Ello IN 3.0)

∨
ELLO IN 1.0
 with spacer (15° inclination)



STANDARD FINISHES



White



Chrome



Pure orange



Reseda green

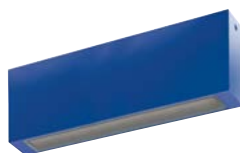

Capri blue



Light ivory

< **ELLO IN 3.0**
 3000K, 19W, white
 Private residence, Milan, Italy

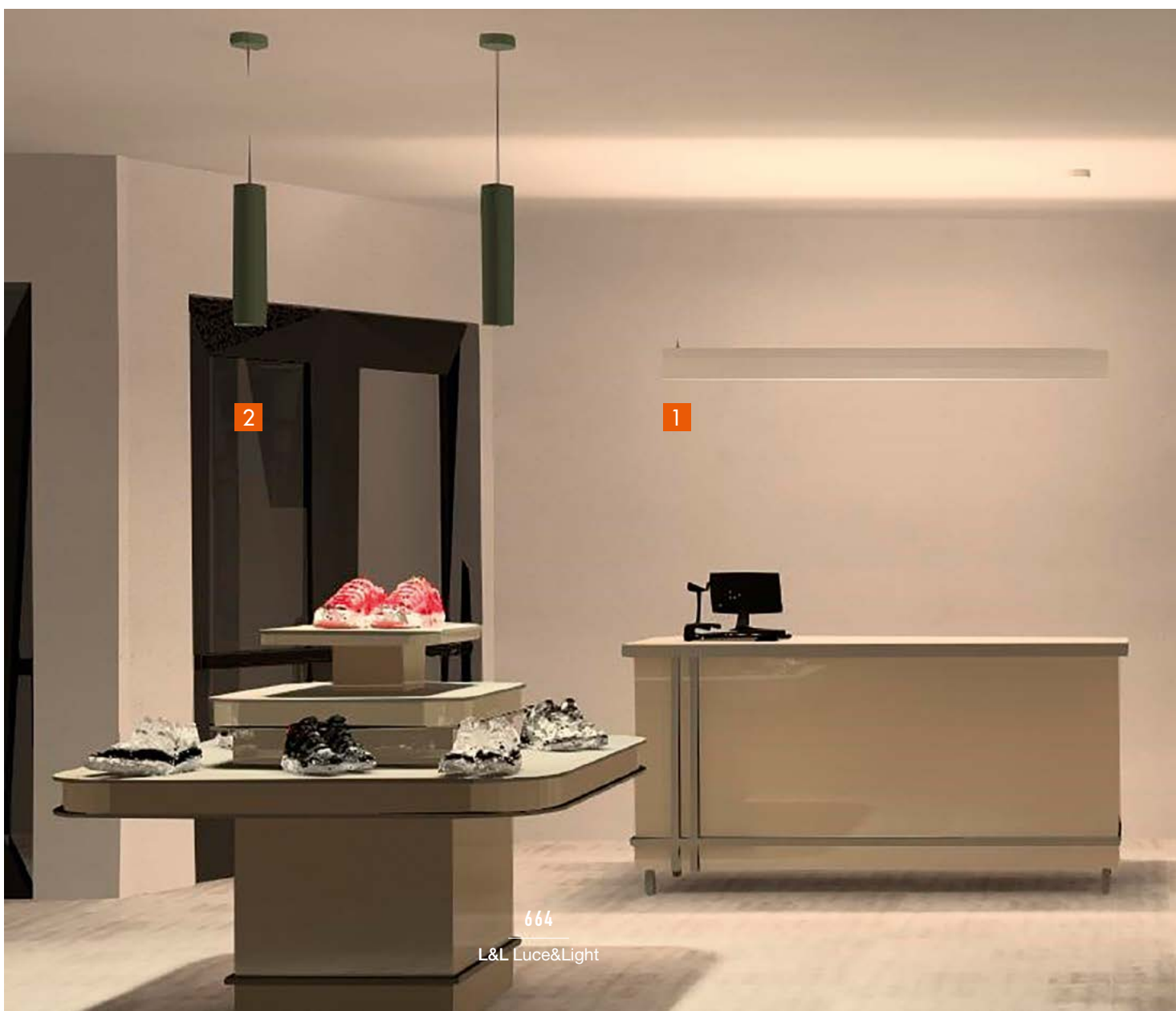

2

1

SUSPENDED FOR INDOOR APPLICATIONS



BERICA S p. 668 **1**





KORA p. 676 **2**

2



665

L&L Luce&Light

	OPTICS	BEAM	LIGHT COLOUR	POWER SUPPLY
BERICA S see p. 668  RETAIL, HOSPITALITY, OFFICES, PRIVATE HOMES	DIFFUSE ELLIPTICAL	DOUBLE BEAM	 2700K 3000K 4000K	MAINS VOLTAGE (built-in power supply unit) 230Vac
KORA see p. 676  PRIVATE HOMES, HOSPITALITY	ROTATIONALLY SYMMETRICAL	SINGLE BEAM	 2700K 3000K 4000K	MAINS VOLTAGE (built-in power supply unit) 230Vac

SUSPENDED FOR INDOOR APPLICATIONS



IP	CONTROL SYSTEM	APPLIANCE CLASS	UNIQUE SELLING POINTS
IP40	ON/OFF DALI		version with primer
IP40	ON/OFF		



SUSPENDED FOR INDOOR APPLICATIONS DOUBLE BEAM FOR RETAIL, HOSPITALITY, OFFICES AND PRIVATE HOMES



diffuse elliptical



2700K 3000K 4000K

620 mm

1180 mm

1740 mm

CONVEX COVER



BERICA S 1.0 p. 670
14W 230Vac
ON/OFF, DALI+PUSH



BERICA S 1.1 p. 671
28W 230Vac
ON/OFF, DALI+PUSH



BERICA S 1.2 p. 671
39W 230Vac
ON/OFF, DALI+PUSH

FLAT COVER



BERICA S 2.0 p. 672
14W 230Vac
ON/OFF, DALI+PUSH



BERICA S 2.1 p. 673
28W 230Vac
ON/OFF, DALI+PUSH



BERICA S 2.2 p. 673
39W 230Vac
ON/OFF, DALI+PUSH

CONCAVE COVER



BERICA S 3.0 p. 674
14W 230Vac
ON/OFF, DALI+PUSH



BERICA S 3.1 p. 675
28W 230Vac
ON/OFF, DALI+PUSH



BERICA S 3.2 p. 675
39W 230Vac
ON/OFF, DALI+PUSH

INDOOR WALL MOUNTED

BERICA IN p. 608

OUTDOOR WALL MOUNTED

BERICA OUT p. 316



^
BERICA S 2.0
 3000K, 14W, 58°x99°, antique bronze

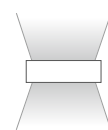
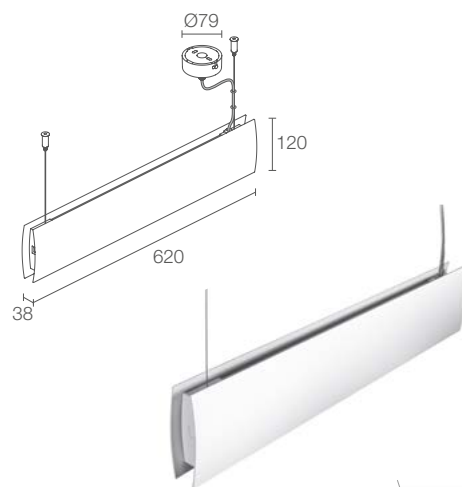

BERICA S 1.0

CE ENEC LED TECH kg 2.0 IP40 DALI PUSH
 A A+ A++

POWER / POWER SUPPLY CODE

14W 230Vac
BS10101 ■ 00 ■ D ■ B White
BS10101 ■ 00 ■ D ■ 6 Antique white
BS10101 ■ 00 ■ D ■ Z Antique bronze
BS10101 ■ 00 ■ D ■ K Matt aluminium grey
BS10101 ■ 00 ■ D ■ 8 Primer

■ CONTROL SYSTEM	0 - on/off D - DALI+PUSH
■ LED COLOUR	F - 2700K 5 - 3000K 9 - 4000K
■ LOWER OPTICS	L - 44°x90° K - 58°x99° D - diffuse
UPPER OPTICS	diffuse

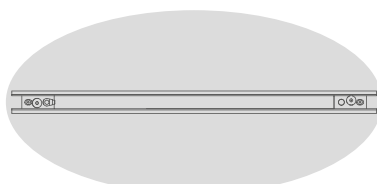

44°x90° optics

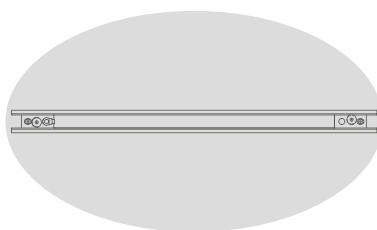

58°x99° optics

LUMEN OUTPUT AT SOURCE	1647 lm (3000K)
DELIVERED LUMEN OUTPUT	1159 lm (3000K, 44°x90°+ diffuse)
NO. AND TYPE OF LED	84 mid-power LEDs 3-step MacAdam, 60 000h L90 B10 (Ta 25°C)
MATERIAL	body and cover in anticorrosional aluminium ceiling rose in steel
POWER SUPPLY UNIT	built in
POWER CABLES	on/off: includes 2.5 m PVC + PVC cable 2x0.75 Ø5.4 mm DALI: includes 2.5 m PVC + PVC cable 5x0.75 Ø6.6 mm
MOUNTING	surface mounted (ceiling) with ceiling rose
FEATURES	CRI >90
NOTES	indoor wall-mounted version: Berica IN 1, p. 612 outdoor wall-mounted version: Berica OUT 1, p. 318 non-standard lengths available on request single-beam version available on request Casambi-compatible version, controllable with the Casambi app, available on request
PHOTOMETRIC DATA	see p. 788

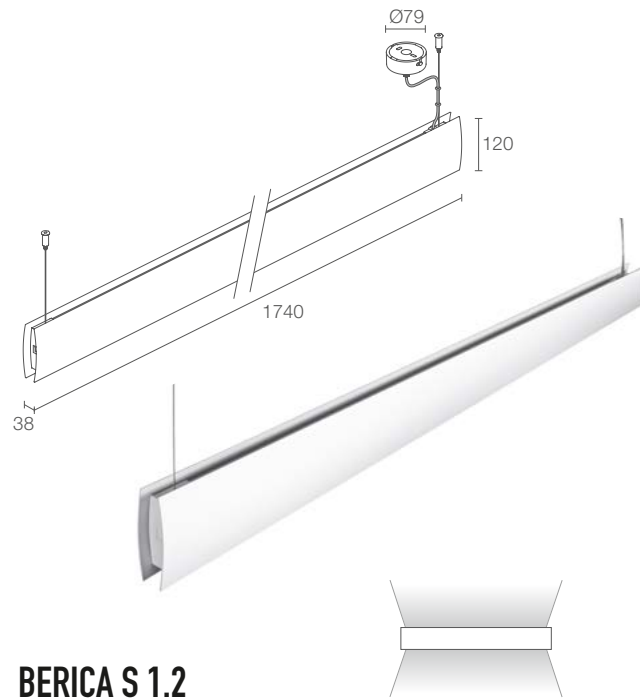
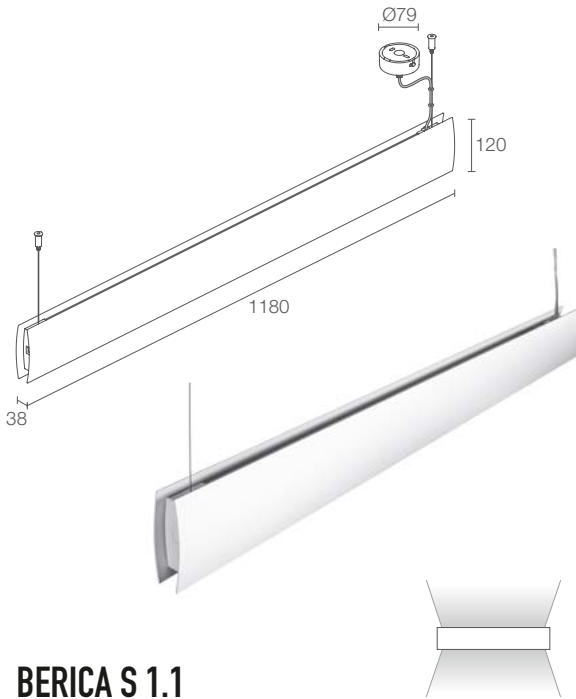

BERICA S 1.1

BERICA S 1.2

CE ENEC LED TECH IP40 DALI PUSH
 A A+ A++

CE ENEC LED TECH IP40 DALI PUSH
 A A+ A++

28W 230Vac

BS11101 ■ **00** ■ **D** ■ **B** White
BS11101 ■ **00** ■ **D** ■ **6** Antique white
BS11101 ■ **00** ■ **D** ■ **Z** Antique bronze
BS11101 ■ **00** ■ **D** ■ **K** Matt aluminium grey
BS11101 ■ **00** ■ **D** ■ **8** Primer

39W 230Vac

BS12101 ■ **00** ■ **D** ■ **B** White
BS12101 ■ **00** ■ **D** ■ **6** Antique white
BS12101 ■ **00** ■ **D** ■ **Z** Antique bronze
BS12101 ■ **00** ■ **D** ■ **K** Matt aluminium grey
BS12101 ■ **00** ■ **D** ■ **8** Primer

■ **0** - on/off
 ■ **D** - DALI+PUSH

■ **0** - on/off
 ■ **D** - DALI+PUSH

■ **F** - 2700K
 ■ **5** - 3000K
 ■ **9** - 4000K

■ **F** - 2700K
 ■ **5** - 3000K
 ■ **9** - 4000K

■ **L** - 44°x90°
 ■ **K** - 58°x99°
 ■ **D** - diffuse

■ **L** - 44°x90°
 ■ **K** - 58°x99°
 ■ **D** - diffuse

diffuse

diffuse

3312 lm (3000K)

4747 lm (3000K)

2320 lm (3000K, 44°x90°+ diffuse)

3333 lm (3000K, 44°x90°+ diffuse)

180 mid-power LEDs
 3-step MacAdam, 60000h L90 B10 (Ta 25°C)

270 mid-power LEDs
 3-step MacAdam, 60000h L90 B10 (Ta 25°C)

body and cover in anticorrosional aluminium
 ceiling rose in steel

body and cover in anticorrosional aluminium
 ceiling rose in steel

built in

built in

on/off: includes 2.5 m PVC + PVC cable
 2x0.75 Ø5.4 mm
 DALI: includes 2.5 m PVC + PVC cable
 5x0.75 Ø6.6 mm

on/off: includes 2.5 m PVC + PVC cable
 2x0.75 Ø5.4 mm
 DALI: includes 2.5 m PVC + PVC cable
 5x0.75 Ø6.6 mm

surface mounted (ceiling) with ceiling rose

surface mounted (ceiling) with ceiling rose

CRI >90

CRI >90

indoor wall-mounted version: Berica IN 1, p. 612
 outdoor wall-mounted version: Berica OUT 1, p. 318
 non-standard lengths available on request
 single-beam version available on request
 Casambi-compatible version, controllable with
 the Casambi app, available on request

indoor wall-mounted version: Berica IN 1, p. 612
 outdoor wall-mounted version: Berica OUT 1, p. 318
 non-standard lengths available on request
 single-beam version available on request
 Casambi-compatible version, controllable with
 the Casambi app, available on request

see p. 788

see p. 788





^
BERICA S 2.0
antique bronze

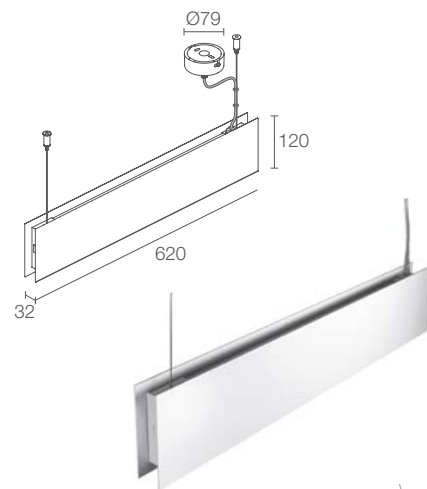

BERICA S 2.0

CE ENEC LED TECH IP40 DALI PUSH
A A+ A++

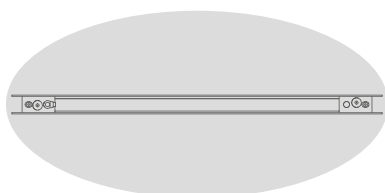

44°x90° optics

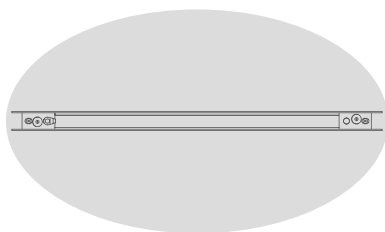

58°x99° optics

POWER / POWER SUPPLY CODE 14W 230Vac
BS20101 ■ 00 ■ D ■ B White
BS20101 ■ 00 ■ D ■ 6 Antique white
BS20101 ■ 00 ■ D ■ Z Antique bronze
BS20101 ■ 00 ■ D ■ K Matt aluminium grey
BS20101 ■ 00 ■ D ■ 8 Primer

■ CONTROL SYSTEM	0 - on/off D - DALI+PUSH
■ LED COLOUR	F - 2700K 5 - 3000K 9 - 4000K
■ LOWER OPTICS	L - 44°x90° K - 58°x99° D - diffuse
UPPER OPTICS	diffuse

LUMEN OUTPUT AT SOURCE	1647 lm (3000K)
DELIVERED LUMEN OUTPUT	1325 lm (3000K, 44°x90°+ diffuse)
NO. AND TYPE OF LED	84 mid-power LEDs 3-step MacAdam, 60000h L90 B10 (Ta 25°C)
MATERIAL	body and cover in anticorrosional aluminium ceiling rose in steel
POWER SUPPLY UNIT	built in
POWER CABLES	on/off: includes 2.5 m PVC + PVC cable 2x0.75 Ø5.4 mm DALI: includes 2.5 m PVC + PVC cable 5x0.75 Ø6.6 mm
MOUNTING	surface mounted (ceiling) with ceiling rose
FEATURES	CRI >90
NOTES	indoor wall-mounted version: Berica IN 2, p. 614 outdoor wall-mounted version: Berica OUT 2, p. 320 non-standard lengths available on request single-beam version available on request Casambi-compatible version, controllable with the Casambi app, available on request
PHOTOMETRIC DATA	see p. 789

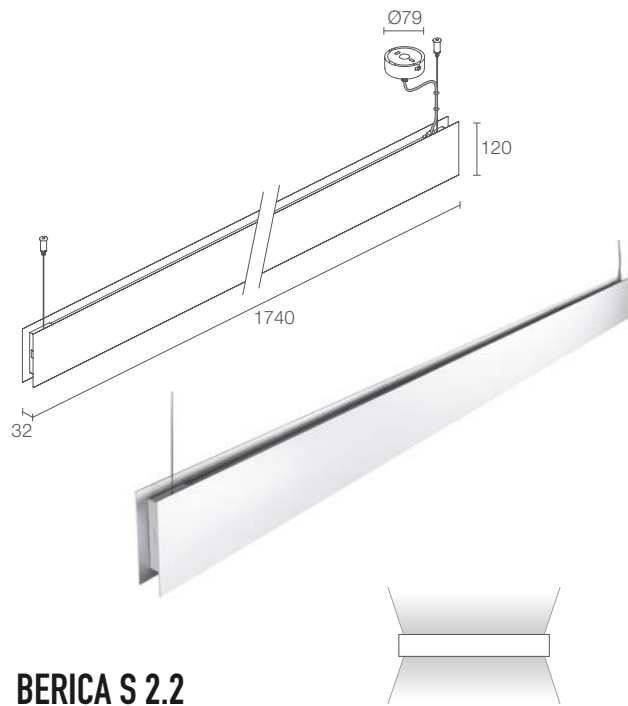
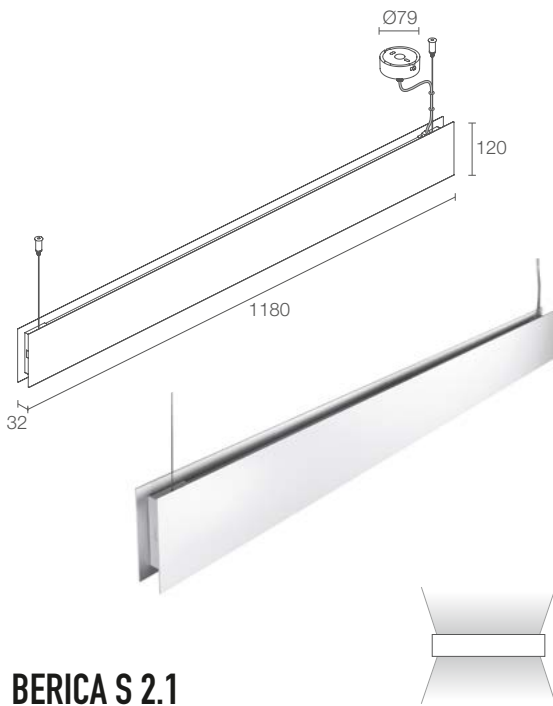

BERICA S 2.1

BERICA S 2.2

CE ENEC LED TECH IP40 DALI PUSH
A A+ A++

CE ENEC LED TECH IP40 DALI PUSH
A A+ A++

28W 230Vac

BS21101 ■ **00** ■ **D** ■ **B** White
BS21101 ■ **00** ■ **D** ■ **6** Antique white
BS21101 ■ **00** ■ **D** ■ **Z** Antique bronze
BS21101 ■ **00** ■ **D** ■ **K** Matt aluminium grey
BS21101 ■ **00** ■ **D** ■ **8** Primer

39W 230Vac

BS22101 ■ **00** ■ **D** ■ **B** White
BS22101 ■ **00** ■ **D** ■ **6** Antique white
BS22101 ■ **00** ■ **D** ■ **Z** Antique bronze
BS22101 ■ **00** ■ **D** ■ **K** Matt aluminium grey
BS22101 ■ **00** ■ **D** ■ **8** Primer

■ **0** - on/off
 ■ **D** - DALI+PUSH

■ **0** - on/off
 ■ **D** - DALI+PUSH

■ **F** - 2700K
 ■ **5** - 3000K
 ■ **9** - 4000K

■ **F** - 2700K
 ■ **5** - 3000K
 ■ **9** - 4000K

■ **L** - 44°x90°
 ■ **K** - 58°x99°
 ■ **D** - diffuse

■ **L** - 44°x90°
 ■ **K** - 58°x99°
 ■ **D** - diffuse

diffuse

diffuse

3312 lm (3000K)

4747 lm (3000K)

2653 lm (3000K, 44°x90°+ diffuse)

3800 lm (3000K, 44°x90°+ diffuse)

180 mid-power LEDs
 3-step MacAdam, 60000h L90 B10 (Ta 25°C)

270 mid-power LEDs
 3-step MacAdam, 60000h L90 B10 (Ta 25°C)

body and cover in anticorodal aluminium
 ceiling rose in steel

body and cover in anticorodal aluminium
 ceiling rose in steel

built in

built in

on/off: includes 2.5 m PVC + PVC cable
 2x0.75 Ø5.4 mm
 DALI: includes 2.5 m PVC + PVC cable
 5x0.75 Ø6.6 mm

on/off: includes 2.5 m PVC + PVC cable
 2x0.75 Ø5.4 mm
 DALI: includes 2.5 m PVC + PVC cable
 5x0.75 Ø6.6 mm

surface mounted (ceiling) with ceiling rose

surface mounted (ceiling) with ceiling rose

CRI >90

CRI >90

indoor wall-mounted version: Berica IN 2, p. 614
 outdoor wall-mounted version: Berica OUT 2, p. 320
 non-standard lengths available on request
 single-beam version available on request
 Casambi-compatible version, controllable with
 the Casambi app, available on request

indoor wall-mounted version: Berica IN 2, p. 614
 outdoor wall-mounted version: Berica OUT 2, p. 320
 non-standard lengths available on request
 single-beam version available on request
 Casambi-compatible version, controllable with
 the Casambi app, available on request

see p. 789

see p. 789



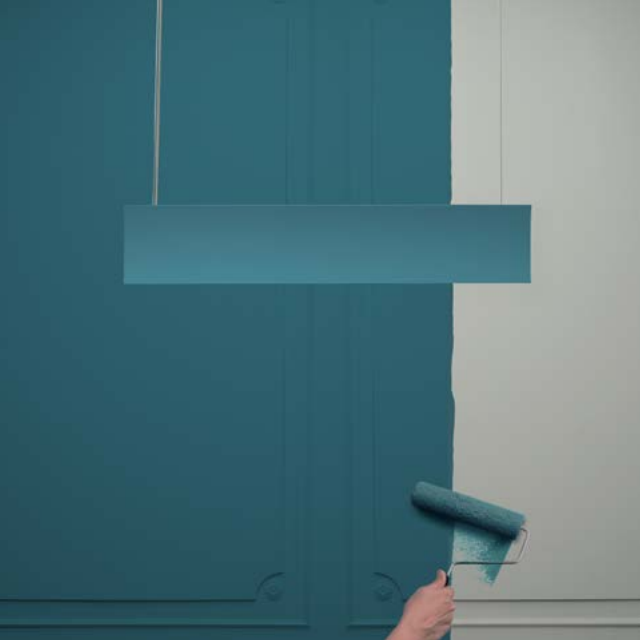

^
BERICA S 3.0
painted primer version

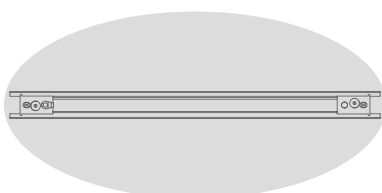
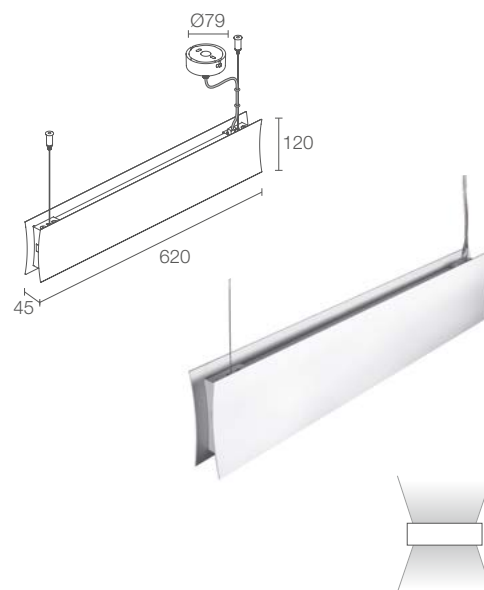

44°x90° optics

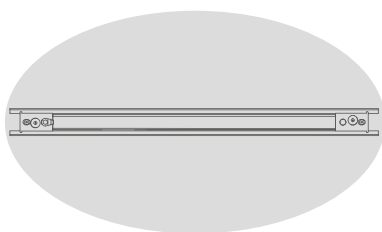

58°x99° optics

BERICA S 3.0

CE ENEC LED TECH kg 2.0 IP40 DALI PUSH
A A+ A++

POWER / POWER SUPPLY CODE	14W 230Vac
BS30101	00 D B White
BS30101	00 D 6 Antique white
BS30101	00 D Z Antique bronze
BS30101	00 D K Matt aluminium grey
BS30101	00 D 8 Primer

CONTROL SYSTEM	0 - on/off D - DALI+PUSH
LED COLOUR	F - 2700K 5 - 3000K 9 - 4000K
LOWER OPTICS	L - 44°x90° K - 58°x99° D - diffuse
UPPER OPTICS	diffuse

LUMEN OUTPUT AT SOURCE	1647 lm (3000K)
DELIVERED LUMEN OUTPUT	1432 lm (3000K, 44°x90° + diffuse)
NO. AND TYPE OF LED	84 mid-power LEDs 3-step MacAdam, 60000h L90 B10 (Ta 25°C)
MATERIAL	body and cover in anticorrosional aluminium ceiling rose in steel
POWER SUPPLY UNIT	built in
POWER CABLES	on/off: includes 2.5 m PVC + PVC cable 2x0.75 Ø5.4 mm DALI: includes 2.5 m PVC + PVC cable 5x0.75 Ø6.6 mm
MOUNTING	surface mounted (ceiling) with ceiling rose
FEATURES	CRI >90
NOTES	indoor wall-mounted version: Berica IN 3, p. 616 outdoor wall-mounted version: Berica OUT 3, p. 322 non-standard lengths available on request single-beam version available on request Casambi-compatible version, controllable with the Casambi app, available on request
PHOTOMETRIC DATA	see p. 790

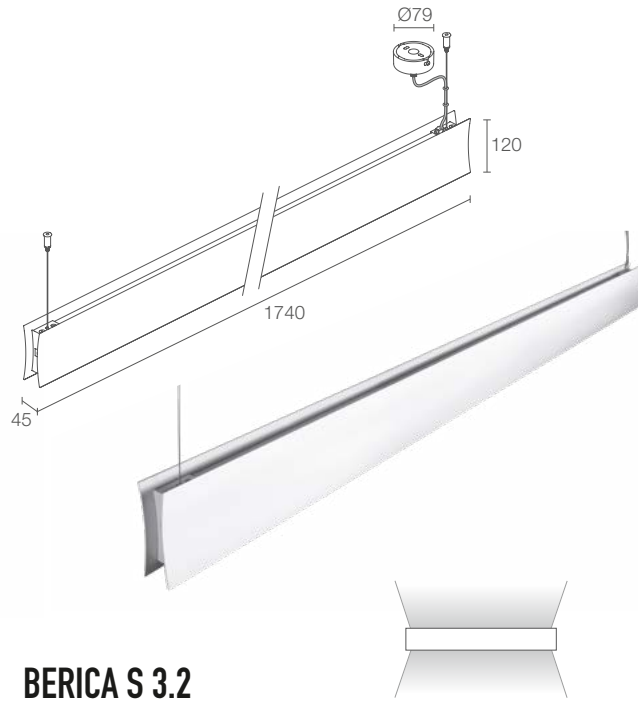
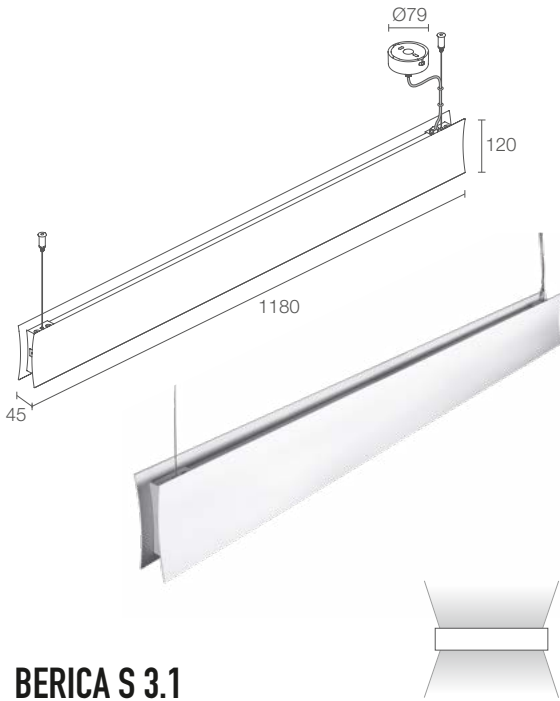

BERICA S 3.1

BERICA S 3.2

CE ENEC LED TECH □ kg 3.8 IP40 DALI PUSH
 A A+ A++

CE ENEC LED TECH □ kg 5.1 IP40 DALI PUSH
 A A+ A++

28W 230Vac

BS31101 ■ **00** ■ **D** ■ **B** White
BS31101 ■ **00** ■ **D** ■ **6** Antique white
BS31101 ■ **00** ■ **D** ■ **Z** Antique bronze
BS31101 ■ **00** ■ **D** ■ **K** Matt aluminium grey
BS31101 ■ **00** ■ **D** ■ **8** Primer

39W 230Vac

BS32101 ■ **00** ■ **D** ■ **B** White
BS32101 ■ **00** ■ **D** ■ **6** Antique white
BS32101 ■ **00** ■ **D** ■ **Z** Antique bronze
BS32101 ■ **00** ■ **D** ■ **K** Matt aluminium grey
BS32101 ■ **00** ■ **D** ■ **8** Primer

■ **0** - on/off
 ■ **D** - DALI+PUSH

■ **0** - on/off
 ■ **D** - DALI+PUSH

■ **F** - 2700K
 ■ **5** - 3000K
 ■ **9** - 4000K

■ **F** - 2700K
 ■ **5** - 3000K
 ■ **9** - 4000K

■ **L** - 44°x90°
 ■ **K** - 58°x99°
 ■ **D** - diffuse

■ **L** - 44°x90°
 ■ **K** - 58°x99°
 ■ **D** - diffuse

diffuse

diffuse

3312 lm (3000K)

4747 lm (3000K)

2881 lm (3000K, 44°x90°+ diffuse)

4129 lm (3000K, 44°x90°+ diffuse)

180 mid-power LEDs
 3-step MacAdam, 60000h L90 B10 (Ta 25°C)

270 mid-power LEDs
 3-step MacAdam, 60000h L90 B10 (Ta 25°C)

body and cover in anticorodal aluminium
 ceiling rose in steel

body and cover in anticorodal aluminium
 ceiling rose in steel

built in

built in

on/off: includes 2.5 m PVC + PVC cable
 2x0.75 Ø5.4 mm
 DALI: includes 2.5 m PVC + PVC cable
 5x0.75 Ø6.6 mm

on/off: includes 2.5 m PVC + PVC cable
 2x0.75 Ø5.4 mm
 DALI: includes 2.5 m PVC + PVC cable
 5x0.75 Ø6.6 mm

surface mounted (ceiling) with ceiling rose

surface mounted (ceiling) with ceiling rose

CRI >90

CRI >90

indoor wall-mounted version: Berica IN 3, p. 616
 outdoor wall-mounted version: Berica OUT 3, p. 322
 non-standard lengths available on request
 single-beam version available on request
 Casambi-compatible version, controllable with
 the Casambi app, available on request

indoor wall-mounted version: Berica IN 3, p. 616
 outdoor wall-mounted version: Berica OUT 3, p. 322
 non-standard lengths available on request
 single-beam version available on request
 Casambi-compatible version, controllable with
 the Casambi app, available on request

see p. 790

see p. 790





INDOOR SUSPENDED LIGHTING FOR HOSPITALITY AND PRIVATE HOMES



2700K 3000K 4000K



KORA 1.0 p. 678
3.5W 230Vac



narrow medium



KORA 2.0 p. 679
6W 230Vac



narrow medium wide



KORA 3.0 p. 679
21W 230Vac



narrow medium wide

▼
KORA 3.0
 3000K, 21W, 38°, white

Interior design by / Cristian Turra
 Photo by / Alessio Tamborini
 Private residence, Brescia, Italy

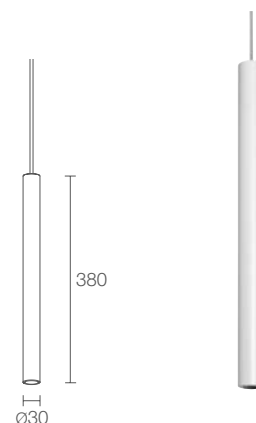

KORA 1.0

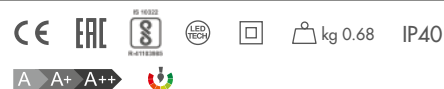

POWER / POWER SUPPLY CODE

3.5W 230Vac
KR101010 ■ B White
KR101010 ■ C Chrome
KR101010 ■ N Black
KR101010 ■ 1 Pure orange
KR101010 ■ 2 Reseda green
KR101010 ■ 3 Capri blue
KR101010 ■ 4 Light ivory

LED COLOUR

F - 2700K
5 - 3000K
9 - 4000K

OPTICS

S - 18°
M - 35°

LUMEN OUTPUT AT SOURCE	184 lm (3000K)
DELIVERED LUMEN OUTPUT	120 lm (3000K, 35°)
NO. AND TYPE OF LED	1 power LED 1/4 ANSI BIN, 50000h L90 B10 (Ta 25°C)
MATERIAL	body in anticorodal aluminium ceiling rose in steel
POWER SUPPLY UNIT	built in
POWER CABLES	includes 2.50 m PVC cable FROR 2x0.75 Ø5.4 mm
MOUNTING	surface mounted (ceiling) with ceiling rose
NOTES	Casambi-compatible version, controllable with the Casambi app, available on request
DESIGN BY	Cibicworkshop
PHOTOMETRIC DATA	see p. 841

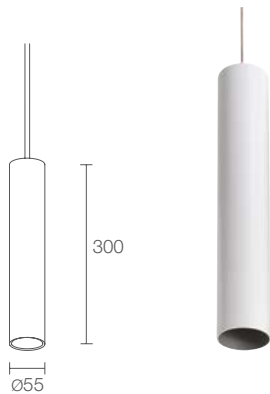

KORA 2.0



6W 230Vac

- KR2010** ■ ■ **B** White
- KR2010** ■ ■ **C** Chrome
- KR2010** ■ ■ **N** Black
- KR2010** ■ ■ **1** Pure orange
- KR2010** ■ ■ **2** Reseda green
- KR2010** ■ ■ **3** Capri blue
- KR2010** ■ ■ **4** Light ivory

- **F** - 2700K
- **5** - 3000K
- **9** - 4000K

- **S** - 17°
- **M** - 24°
- **L** - 58°

460 lm (3000K)

285 lm (3000K, 24°)

1 multichip power LED
3-step MacAdam, 50000h L80 B10 (Ta 25°C)

body in anticorodal aluminium, ceiling rose in steel
screen in plexiglass

built in

includes 2.50 m PVC cable
FROR 2x0.75 Ø5.4 mm

surface mounted (ceiling) with ceiling rose

DALI and 0/1-10V versions available on request
Casambi-compatible version, controllable with the
Casambi app, available on request

Cibicworkshop

see p. 841

KORA 3.0



21W 230Vac

- KR3010** ■ ■ **B** White
- KR3010** ■ ■ **C** Chrome
- KR3010** ■ ■ **N** Black
- KR3010** ■ ■ **1** Pure orange
- KR3010** ■ ■ **2** Reseda green
- KR3010** ■ ■ **3** Capri blue
- KR3010** ■ ■ **4** Light ivory

- **F** - 2700K
- **5** - 3000K
- **9** - 4000K

- **S** - 23°
- **M** - 38°
- **L** - 65°

1870 lm (3000K)

1289 lm (3000K, 38°)

1 multichip power LED
3-step MacAdam, 50000h L80 B10 (Ta 25°C)

body in anticorodal aluminium, ceiling rose in steel
screen in plexiglass

built in

includes 2.50 m PVC cable
FROR 2x0.75 Ø5.4 mm

surface mounted (ceiling) with ceiling rose

DALI and 0/1-10V versions available on request
Casambi-compatible version, controllable with the
Casambi app, available on request

Cibicworkshop

see p. 841





FINISHES



STANDARD FINISHES



White



Chrome



Black



Pure orange



Reseda green



Capri blue



Light ivory

< **KORA 3.0**
3000K, 65°, customized version with 18W power,
DALL, red RAL finish for body, red cable

Project by / Cibicworkshop
Light planning by / Maurizio Corà
Photo by / Alberto Parise
Glam Hotel, Milan, Italy



LINEAR PROFILES FOR INDOOR APPLICATIONS

BRENTA p. 684

1



683

L&L Luce&Light



INDOOR LINEAR PROFILES FOR LINES OF CONTINUOUS LIGHT



diffuse microprismatic



2700K 3000K 4000K



WIDTH 42 mm

WIDTH 70 mm

STANDARD LENGTHS

562 mm
842 mm
1122 mm
1682 mm
2242 mm
2802 mm



BRENTA 1 p. 686
19W/m 230Vac
27W/m 230Vac



BRENTA 2 p. 688
27W/m 230Vac
54W/m 230Vac

CUSTOM LENGTHS

5000 mm
10000 mm
15000 mm



BRENTA 1 CUSTOM p. 690
19W/m 230Vac
27W/m 230Vac



BRENTA 2 CUSTOM p. 690
27W/m 230Vac
54W/m 230Vac



^
BRENTA 1
flush installation

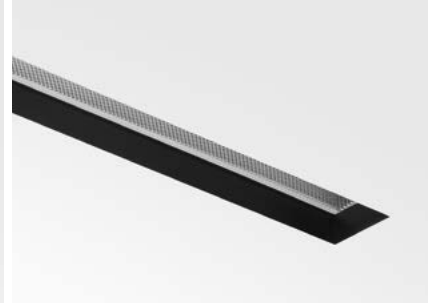

^
BRENTA 1
deep-set installation

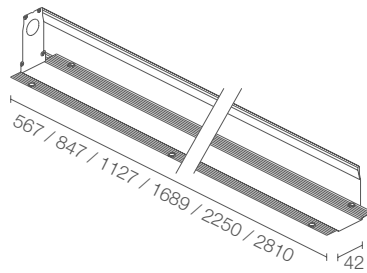

BRENTA 1

Required outer casing, not included
Required screen, not included

CE ENEC LED TECH flush kg/m 2.26 deep set kg/m 2.40 IP40 A A+ A++ DALI

POWER SUPPLY	230Vac	
POWER	19W/m 11W (562 mm) 16W (842 mm) 22W (1122 mm) 33W (1682 mm) 43W (2242 mm) 54W (2802 mm)	27W/m 15W (562 mm) 23W (842 mm) 30W (1122 mm) 46W (1682 mm) 61W (2242 mm) 76W (2802 mm)
LUMEN OUTPUT AT SOURCE	19W/m, 3000K 1780 lm/m	27W/m, 3000K 2500 lm/m
DELIVERED LUMEN OUTPUT	19W/m, 3000K, diffuse optics 1100 lm/m (flush installation) 750 lm/m (deep-set installation) 19W/m, 3000K, microprismatic optics 1000 lm/m (flush installation) 800 lm/m (deep-set installation)	27W/m, 3000K, diffuse optics 1550 lm/m (flush installation) 1050 lm/m (deep-set installation) 27W/m, 3000K, microprismatic optics 1400 lm/m (flush installation) 1100 lm/m (deep-set installation)
NO. AND TYPE OF LED	48 mid-power LEDs (562 mm), 3-step MacAdam, 50000h L90 B10 (Ta 25°C) 72 mid-power LEDs (842 mm), 3-step MacAdam, 50000h L90 B10 (Ta 25°C) 96 mid-power LEDs (1122 mm), 3-step MacAdam, 50000h L90 B10 (Ta 25°C) 144 mid-power LEDs (1682 mm), 3-step MacAdam, 50000h L90 B10 (Ta 25°C) 192 mid-power LEDs (2242 mm), 3-step MacAdam, 50000h L90 B10 (Ta 25°C) 240 mid-power LEDs (2802 mm), 3-step MacAdam, 50000h L90 B10 (Ta 25°C)	
MATERIAL	body in aluminium screen in opal polycarbonate (diffuse version) screen in microprismatic polycarbonate (microprismatic version)	
POWER SUPPLY UNIT	built in	
POWER CABLES	terminal block	
MOUNTING	recessed (ceiling, wall)	
FEATURES	CRI >90	
NOTES	see Brenta Custom, p. 690 Casambi-compatible version, controllable with the Casambi app, available on request	
PHOTOMETRIC DATA	see p. 795	

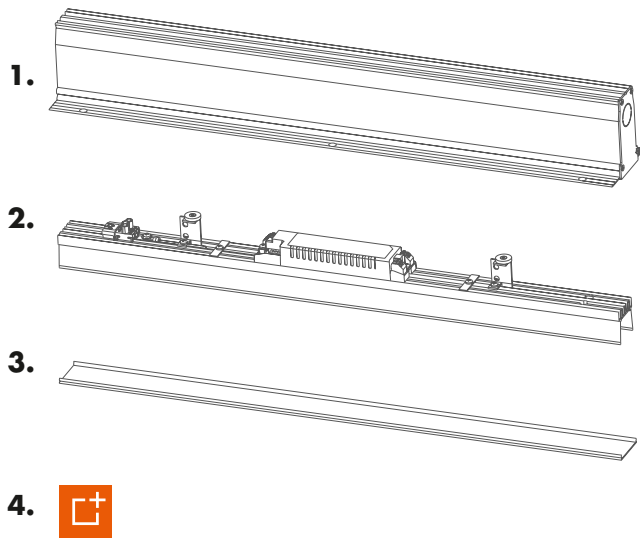

1. OUTER CASING	2. LIGHTING FIXTURE	3. SCREEN	4. ACCESSORIES
<p>WCBR11F - 567 mm WCBR12F - 847 mm WCBR13F - 1127 mm WCBR15F - 1689 mm WCBR17F - 2250 mm WCBR19F - 2810 mm</p> <p>Outer casing for flush installation h 80 mm</p> <p>WCBR11A - 567 mm WCBR12A - 847 mm WCBR13A - 1127 mm WCBR15A - 1689 mm WCBR17A - 2250 mm WCBR19A - 2810 mm</p> <p>Outer casing for deep-set installation – black h 95 mm</p> <p>WCBR190PF - flush installation WCBR190PA - deep-set installation</p> <p>Horizontal L-shaped outer casing 588x620 mm</p> <p>WCBR190SF - flush installation WCBR190SA - deep-set installation</p> <p>Vertical L-shaped outer casing 644x644 mm</p>	<p>CODE DALI 27W/m BR1 ■ 111 ■ OBD</p> <p>ON/OFF BR1 ■ 1 ■ 1 ■ OBO</p> <p>■ LENGTH 1 - 562 mm 2 - 842 mm 3 - 1122 mm 5 - 1682 mm 7 - 2242 mm 9 - 2802 mm</p> <p>■ POWER 0 - 19W/m 1 - 27W/m</p> <p>■ LED COLOUR F - 2700K 5 - 3000K 9 - 4000K</p>	<p>WRBR11D - 563 mm WRBR12D - 843 mm WRBR13D - 1123 mm WRBR15D - 1685 mm WRBR17D - 2246 mm WRBR19D - 2806 mm</p> <p>Diffuse optics</p> <p>WRBR11P - 563 mm WRBR12P - 843 mm WRBR13P - 1123 mm WRBR15P - 1685 mm WRBR17P - 2246 mm WRBR19P - 2806 mm</p> <p>Microprismatic optics</p>	<p>WABR101A Alignment kit for outer casings</p> <p>WF0321 Five-pin female connector</p> <p>WUBR1000 Casing filler kit</p> <p>WNB001A Anti-fall kit for outer casings: WCBR15F, WCBR15A WCBR17F, WCBR17A WCBR19F, WCBR19A</p> <p>for spare parts, see p. 932</p>

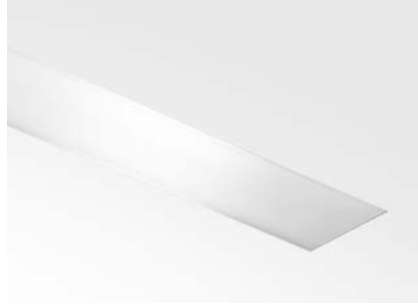

^
BRENTA 2
flush installation

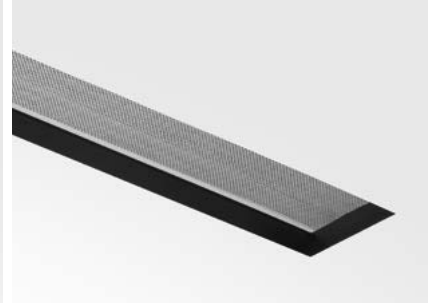

^
BRENTA 2
deep-set installation

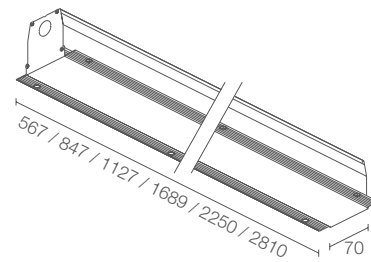

BRENTA 2

Required outer casing, not included
Required screen, not included

CE ENEC LED TECH flush kg/m 3.25 deep set kg/m 3.38 IP40 DALI

POWER SUPPLY	230Vac	
POWER	27W/m 15W (562 mm) 23W (842 mm) 30W (1122 mm) 46W (1682 mm) 61W (2242 mm) 76W (2802 mm)	54W/m 30W (562 mm) 46W (842 mm) 61W (1122 mm) 91W (1682 mm) 122W (2242 mm) 126W (2802 mm)
LUMEN OUTPUT AT SOURCE	27W/m, 3000K 2500 lm/m	54W/m, 3000K 5000 lm/m
DELIVERED LUMEN OUTPUT	27W/m, 3000K, diffuse optics 1550 lm/m (flush installation) 1200 lm/m (deep-set installation) 27W/m, 3000K, microprismatic optics 1500 lm/m (flush installation) 1350 lm/m (deep-set installation)	54W/m, 3000K, diffuse optics 3100 lm/m (flush installation) 2450 lm/m (deep-set installation) 54W/m, 3000K, microprismatic optics 3000 lm/m (flush installation) 2700 lm/m (deep-set installation)
NO. AND TYPE OF LED	96 mid-power LEDs (562 mm), 3-step MacAdam, 50000h L90 B10 (Ta 25°C) 144 mid-power LEDs (842 mm), 3-step MacAdam, 50000h L90 B10 (Ta 25°C) 192 mid-power LEDs (1122 mm), 3-step MacAdam, 50000h L90 B10 (Ta 25°C) 288 mid-power LEDs (1682 mm), 3-step MacAdam, 50000h L90 B10 (Ta 25°C) 384 mid-power LEDs (2242 mm), 3-step MacAdam, 50000h L90 B10 (Ta 25°C) 480 mid-power LEDs (2802 mm), 3-step MacAdam, 50000h L90 B10 (Ta 25°C)	
MATERIAL	body in aluminium screen in opal polycarbonate (diffuse version) screen in microprismatic polycarbonate (microprismatic version)	
POWER SUPPLY UNIT	built in	
POWER CABLES	terminal block	
MOUNTING	recessed (ceiling, wall)	
FEATURES	CRI >90	
NOTES	see Brenta Custom, p. 690 Casambi-compatible version, controllable with the Casambi app, available on request	
PHOTOMETRIC DATA	see p. 795	

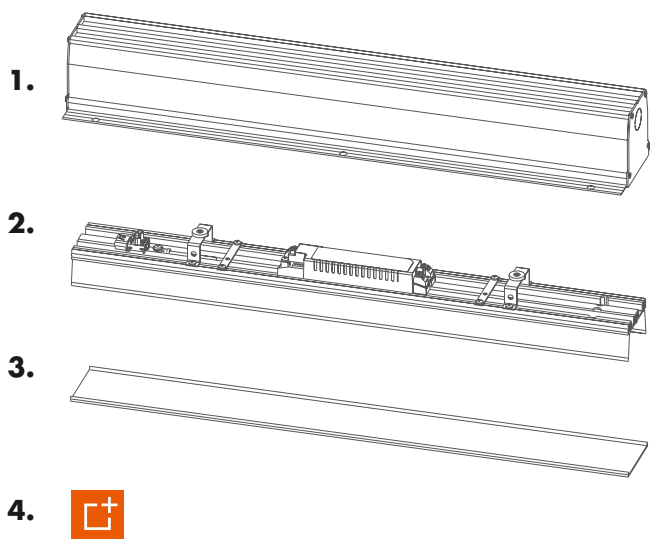

1. OUTER CASING	2. LIGHTING FIXTURE	3. SCREEN	4. ACCESSORIES
<p>WCBR21F - 567 mm WCBR22F - 847 mm WCBR23F - 1127 mm WCBR25F - 1689 mm WCBR27F - 2250 mm WCBR29F - 2810 mm</p> <p>Outer casing for flush installation h 76 mm</p> <p>WCBR21A - 567 mm WCBR22A - 847 mm WCBR23A - 1127 mm WCBR25A - 1689 mm WCBR27A - 2250 mm WCBR29A - 2810 mm</p> <p>Outer casing for deep-set installation – black h 91 mm</p> <p>WCBR290PF - flush installation WCBR290PA - deep-set installation</p> <p>Horizontal L-shaped outer casing 588x648 mm</p> <p>WCBR290SF - flush installation WCBR290SA - deep-set installation</p> <p>Vertical L-shaped outer casing 634x634 mm</p>	<p>CODE DALI 54W/m BR2 ■ 111 ■ OBD</p> <p>ON/OFF BR2 ■ 1 ■ 1 ■ OBO</p> <p>■ LENGTH 1 - 562 mm 2 - 842 mm 3 - 1122 mm 5 - 1682 mm 7 - 2242 mm 9 - 2802 mm</p> <p>■ POWER 0 - 27W/m 1 - 54W/m</p> <p>■ LED COLOUR F - 2700K 5 - 3000K 9 - 4000K</p>	<p>WRBR21D - 563 mm WRBR22D - 843 mm WRBR23D - 1123 mm WRBR25D - 1685 mm WRBR27D - 2246 mm WRBR29D - 2806 mm</p> <p>Diffuse optics</p> <p>WRBR21P - 563 mm WRBR22P - 843 mm WRBR23P - 1123 mm WRBR25P - 1685 mm WRBR27P - 2246 mm WRBR29P - 2806 mm</p> <p>Microprismatic optics</p>	<p>WHBR2000 Honeycomb louvre 562 mm version: 4 pieces honeycomb louvre 842 mm version: 6 pieces honeycomb louvre 1122 mm version: 8 pieces honeycomb louvre 1682 mm version: 12 pieces honeycomb louvre 2242 mm version: 16 pieces honeycomb louvre 2802 mm version: 20 pieces honeycomb louvre</p> <p>The honeycomb louvre can be fitted on diffuse optics and with outer casing for deep-set installation</p> <p>WABR201A Alignment kit for outer casings</p> <p>WF0321 Five-pin female connector</p> <p>WUBR2000 Casing filler kit</p> <p>WNBRO01A Anti-fall kit for outer casings: WCBR25F, WCBR25A WCBR27F, WCBR27A WCBR29F, WCBR29A</p> <p>for spare parts, see p. 932</p>

BRENTA CUSTOM

ASSEMBLE BRENTA IN THE LENGTH YOU WANT

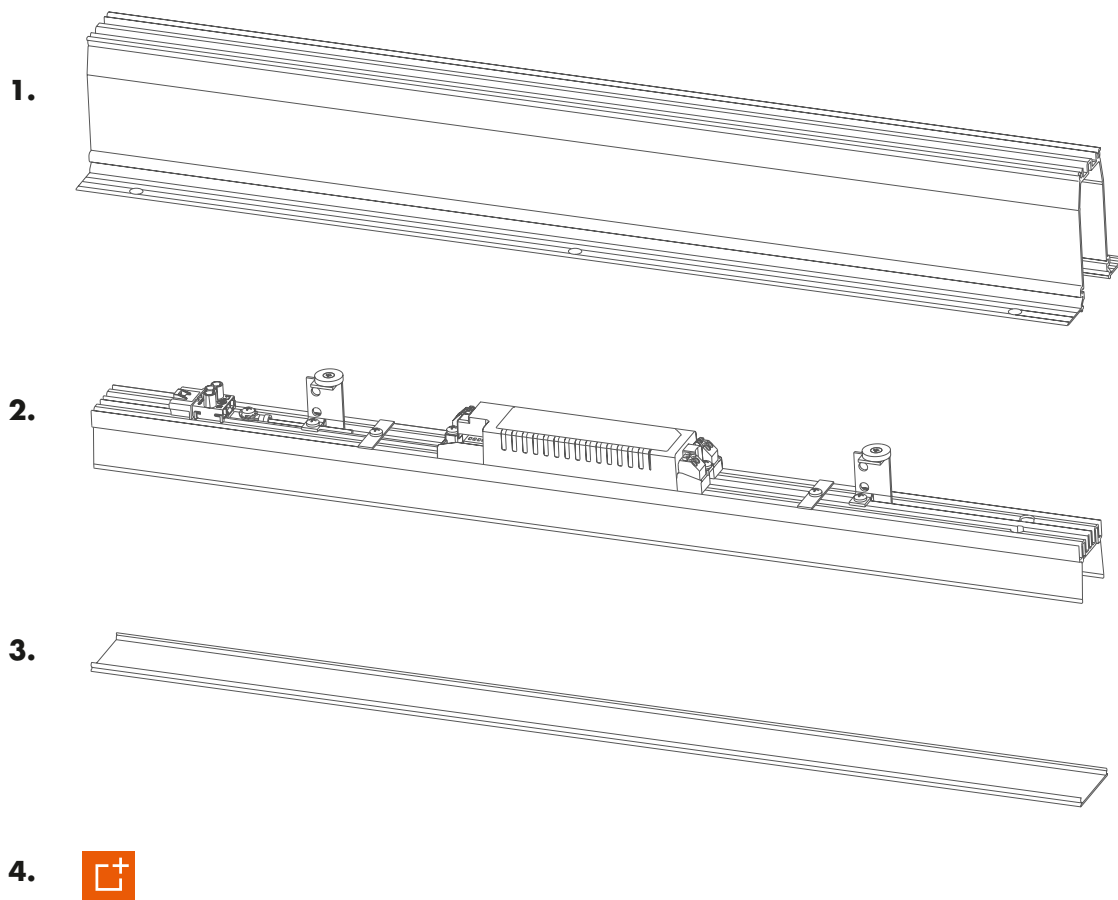

BRENTA 1
3000K, 19W/m, diffuse optics
installation flush with ceiling





690

L&L Luce&Light

1. OUTER CASING	BRENTA 1	BRENTA 2
<p>Outer casing for flush installation see the standard outer casings on p. 687 and 689 to achieve the desired length, if necessary</p> <p>Outer casing for deep-set installation – black see the standard outer casings on p. 687 and 689 to achieve the desired length, if necessary</p> <p>Required outer casing, not included</p>	<p>WCBR17FC 2247 mm</p> <p>WCBR19FC 2807 mm h 80 mm</p> <p>WCBR17AC 2247 mm</p> <p>WCBR19AC 2807 mm h 95 mm</p>	<p>WCBR27FC 2247 mm</p> <p>WCBR29FC 2807 mm h 76 mm</p> <p>WCBR27AC 2247 mm</p> <p>WCBR29AC 2807 mm h 91 mm</p>
<p>2. LIGHTING FIXTURE</p>	<p>CODE DALI 27W/m BR1 ■ 111 ■ OBD ON/OFF BR1 ■ 1 ■ 1 ■ OBO</p> <hr/> <p>■ LENGTH 1 - 562 mm 2 - 842 mm 3 - 1122 mm 5 - 1682 mm 7 - 2242 mm 9 - 2802 mm</p> <p>■ POWER 0 - 19W/m 1 - 27W/m</p> <p>■ LED COLOUR F - 2700K 5 - 3000K 9 - 4000K</p>	<p>CODE DALI 54W/m BR2 ■ 111 ■ OBD ON/OFF BR2 ■ 1 ■ 1 ■ OBO</p> <hr/> <p>■ LENGTH 1 - 562 mm 2 - 842 mm 3 - 1122 mm 5 - 1682 mm 7 - 2242 mm 9 - 2802 mm</p> <p>■ POWER 0 - 27W/m 1 - 54W/m</p> <p>■ LED COLOUR F - 2700K 5 - 3000K 9 - 4000K</p>
<p>3. SCREEN</p> <p>Diffuse optics</p> <p>Microprismatic optics</p> <p>Required screen, not included</p>	<p>WRBR105D 5000 mm</p> <p>WRBR110D 10000 mm</p> <p>WRBR115D 15000 mm</p> <p>WRBR105P 5000 mm</p> <p>WRBR110P 10000 mm</p> <p>WRBR115P 15000 mm</p>	<p>WRBR205D 5000 mm</p> <p>WRBR210D 10000 mm</p> <p>WRBR215D 15000 mm</p> <p>WRBR205P 5000 mm</p> <p>WRBR210P 10000 mm</p> <p>WRBR215P 15000 mm</p>

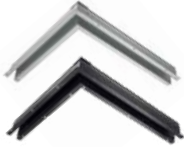
ASSEMBLE BRENTA IN THE LENGTH YOU WANT

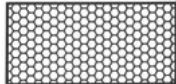
4. ACCESSORIES	BRENTA 1	BRENTA 2
<p>ACCESSORIES FOR INSTALLATION WITH CORNER</p>  <p>Horizontal L-shaped outer casing</p>  <p>Vertical L-shaped outer casing</p>	<p>WCBR190PF Flush installation</p> <p>WCBR190PA Deep-set installation 588x620 mm</p> <p>WCBR190SF Flush installation</p> <p>WCBR190SA Deep-set installation 644x644 mm</p>	<p>WCBR290PF Flush installation</p> <p>WCBR290PA Deep-set installation 588x648 mm</p> <p>WCBR290SF Flush installation</p> <p>WCBR290SA Deep-set installation 634x634 mm</p>
<p>ACCESSORIES FOR INSTALLATION</p> <p>Alignment kit for outer casings</p> <p>Connectors</p> <p>Pair of end caps for outer casings</p> <p>Pair of extractors for outer casings</p> <p>Casing filler kit</p> <p>Anti-fall kit</p>	<p>WABR101A</p> <p>WF0320 Three-pin female connector</p> <p>WF0321 Five-pin female connector</p> <p>WABR100F Flush installation</p> <p>WABR100A Deep-set installation</p> <p>WNBRO00A</p> <p>WUBR1000</p> <p>WNBRO01A for outer casing: WCBR15F, WCBR15A WCBR17F, WCBR17A WCBR19F, WCBR19A WCBR17FC, WCBR17AC WCBR19FC, WCBR19AC</p>	<p>WABR201A</p> <p>WF0320 Three-pin female connector</p> <p>WF0321 Five-pin female connector</p> <p>WABR200F Flush installation</p> <p>WABR200A Deep-set installation</p> <p>WNBRO00A</p> <p>WUBR2000</p> <p>WNBRO01A for outer casing: WCBR25F, WCBR25A WCBR27F, WCBR27A WCBR29F, WCBR29A WCBR27FC, WCBR27AC WCBR29FC, WCBR29AC</p>
<p>ANTI-GLARE ACCESSORIES</p>  <p>Honeycomb louvre</p> <p>the honeycomb louvre can be fitted on diffuse optics and with outer casing for deep-set installation</p>		<p>WHBR2000 length: 140 mm</p>

EXAMPLE OF BRENTA CUSTOM 2 CONFIGURATION

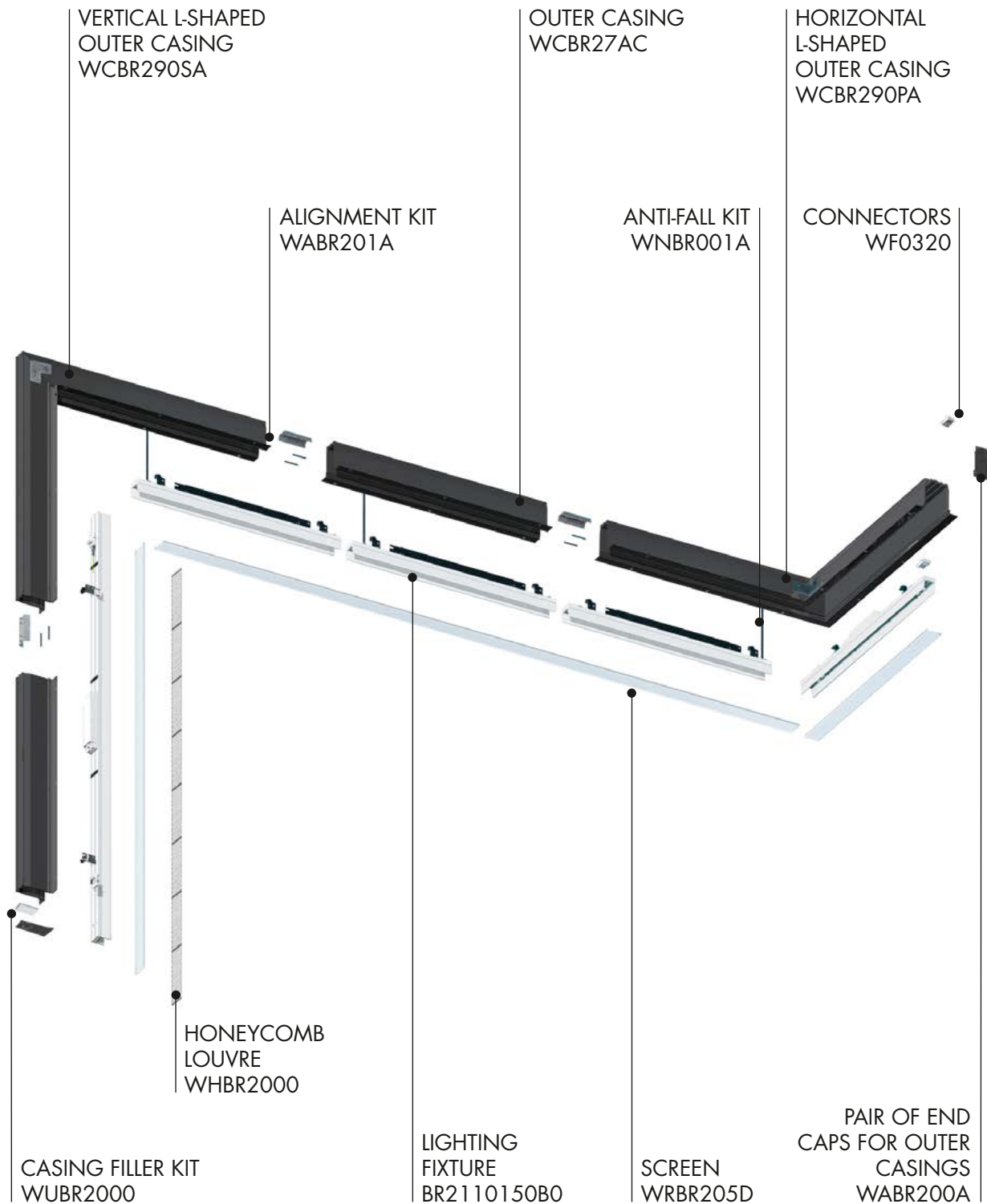

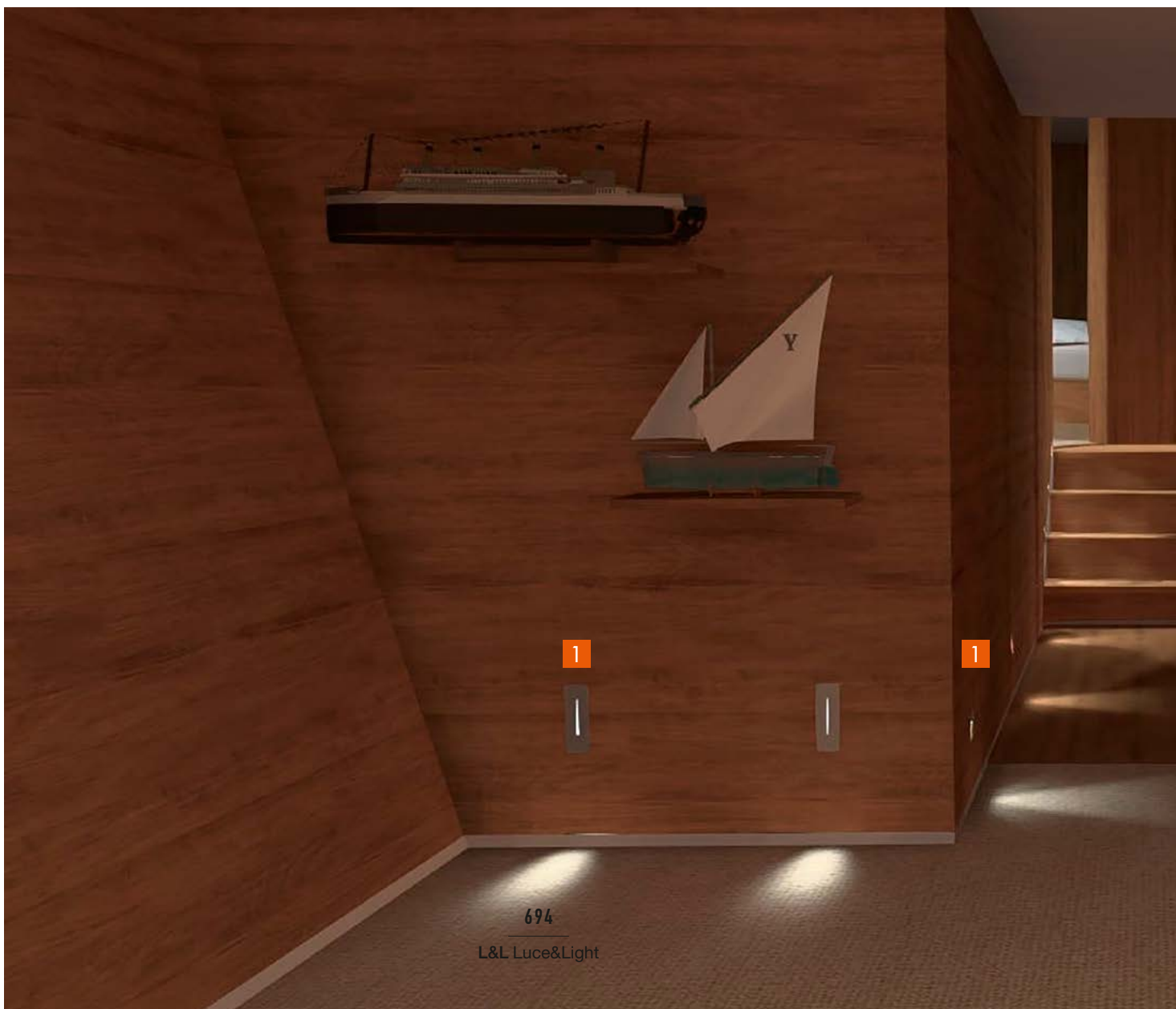

STEP LIGHTS FOR INDOOR APPLICATIONS

ORIENTATION LIGHT

LINE p. 698 **1**

STEP INSIDE p. 704 **2**

SIMPLY p. 710 **3**

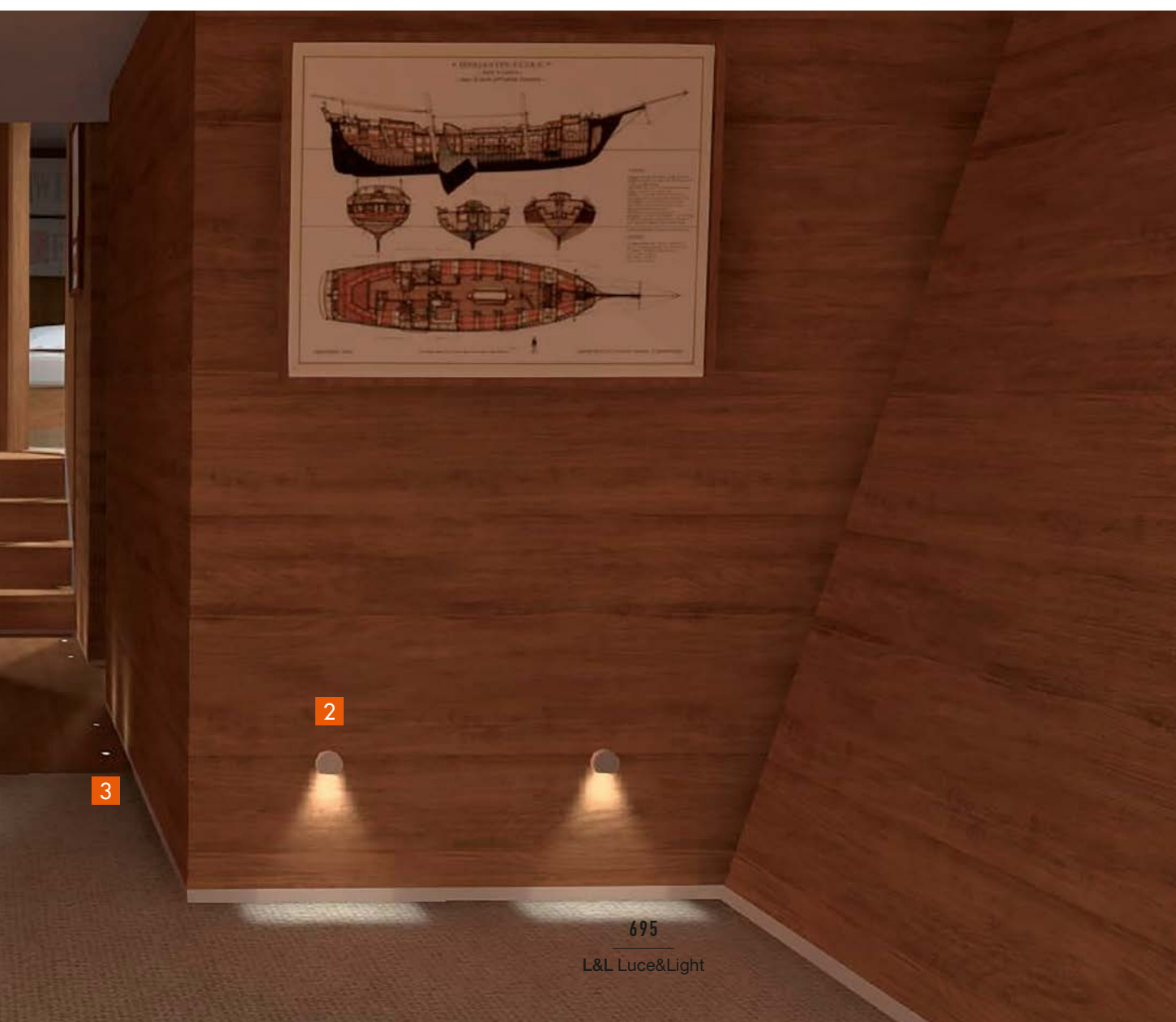

ORIENTATION LIGHT**MOUNTING****LUMINOUS INTENSITY****LIGHT COLOUR****LINE** see p. 698WALL
recessed

2700K 3000K 4000K 5000K blue

STEP INSIDE see p. 704WALL
semi-recessed

2700K 3000K 4000K 5000K blue

SIMPLY see p. 710CEILING
WALL
FLOOR
recessed

2700K 3000K 4000K 5000K blue

STEP LIGHTS FOR INDOOR APPLICATIONS

POWER SUPPLY

IP

APPLIANCE CLASS

CONSTANT CURRENT
(power supply unit not included)
max 500mA

IP20



CONSTANT CURRENT
(power supply unit not included)
max 500mA

IP40



CONSTANT VOLTAGE
(power supply unit not included)
24Vdc

CONSTANT CURRENT
(power supply unit not included)
max 250mA

IP44





INDOOR STEP LIGHTS LIGHTING FOR STAIRS AND CORRIDORS



diffuse

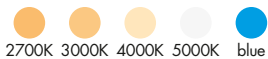

2700K 3000K 4000K 5000K blue

RECESSED IN SOLID WALLS

RECESSED IN PLASTERBOARD WALLS

60x70 mm

max 2W max 500mA



LINE 1.0 p. 700



LINE 1.1 p. 700

55x160 mm

max 2W max 500mA



LINE 2.0 p. 701



LINE 2.1 p. 701

< **LINE 1.0**
3000K, 2W, satin

Interior design by / Cristian Turra
Photo by / Alessio Tamborini
Private residence, Brescia, Italy

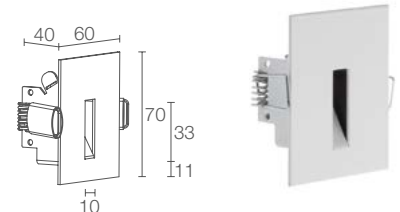
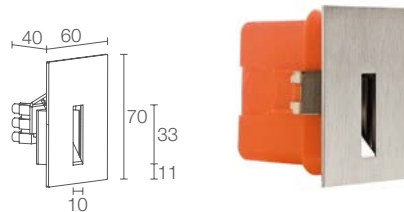

LINE 1.0

Required outer casing, not included



POWER / POWER SUPPLY CODE

max 2W max 500mA
FL1270 ■ **DB** White
FL1270 ■ **DS** Satin
FL1270 ■ **DT** Cor-ten

LED COLOUR

F - 2700K
5 - 3000K
9 - 4000K
0 - 5000K
1 - blue

OPTICS

diffuse

LUMEN OUTPUT AT SOURCE 145 lm (3000K, 500mA)

DELIVERED LUMEN OUTPUT 32 lm (3000K, 500mA)

NO. AND TYPE OF LED 1 power LED
 1/4 ANSI BIN (white LED colour)
 50000h L90 B10 (Ta 25°C)

MATERIAL body and cover in steel

POWER SUPPLY UNIT not included, see p. 904

POWER CABLES terminal block

WIRING series

MOUNTING recessed (solid walls)

ACCESSORIES see p. 703

NOTES certified ETL version available on request

PHOTOMETRIC DATA see p. 844

LINE 1.1

150x150 mm H 70 mm 38x55 mm



max 2W max 500mA
LN1112 ■ **AB** White
LN1112 ■ **AS** Satin
LN1112 ■ **AT** Cor-ten

F - 2700K
5 - 3000K
9 - 4000K
0 - 5000K
1 - blue

diffuse

145 lm (3000K, 500mA)

32 lm (3000K, 500mA)

1 power LED
 1/4 ANSI BIN (white LED colour)
 50000h L90 B10 (Ta 25°C)

body and cover in steel

not included, see p. 904

terminal block

series

recessed (plasterboard)

none

certified ETL version available on request

see p. 844

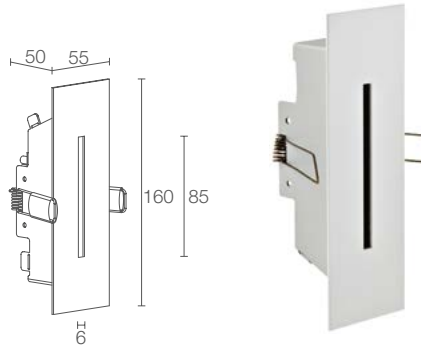
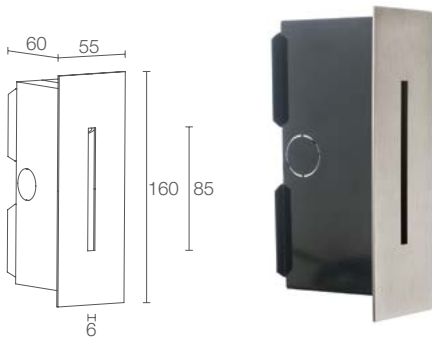

LINE 2.0

Required outer casing, not included

CE EAC LED VECO III kg 0.21 IP20
 A A+ A++ CASAMBI

max 2W max 500mA
LN2012 A B White
LN2012 A S Satin
LN2012 A T Cor-ten

F - 2700K
 5 - 3000K
 9 - 4000K
 0 - 5000K
 1 - blue

diffuse

145 lm (3000K, 500mA)

42 lm (3000K, 500mA)

1 power LED
 1/4 ANSI BIN (white LED colour)
 50000h L90 B10 (T_a 25°C)

body and cover in steel

not included, see p. 904

terminal block

series

recessed (solid walls)

see p. 703

certified ETL version available on request

see p. 844

LINE 2.1

150x210 mm H 70 mm 45x125 mm

CE EAC LED VECO III kg 0.32 IP20
 A A+ A++ CASAMBI

max 2W max 500mA
LN2112 A B White
LN2112 A S Satin
LN2112 A T Cor-ten

F - 2700K
 5 - 3000K
 9 - 4000K
 0 - 5000K
 1 - blue

diffuse

145 lm (3000K, 500mA)

42 lm (3000K, 500mA)

1 power LED
 1/4 ANSI BIN (white LED colour)
 50000h L90 B10 (T_a 25°C)

body and cover in steel

not included, see p. 904

terminal block

series

recessed (plasterboard)

none

certified ETL version available on request

see p. 844





ACCESSORIES AND POSITIONING DIAGRAMS

ACCESSORIES FOR INSTALLATION

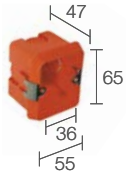

WC0300
Outer casing for solid walls
(Line 1.0)



WC1600
Outer casing for solid walls
(Line 2.0)

POSITIONING DIAGRAMS

LINE 1.0 / 1.1

D - Diffuse

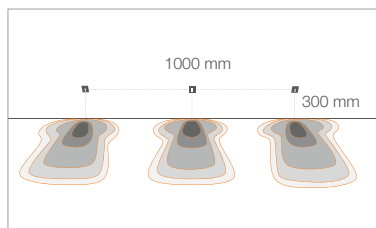
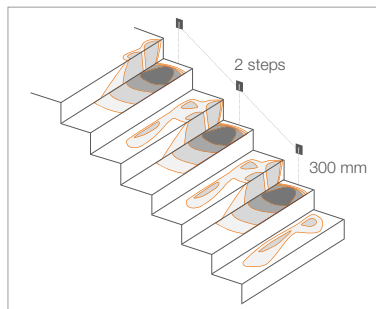

LINE 2.0 / 2.1

D - Diffuse

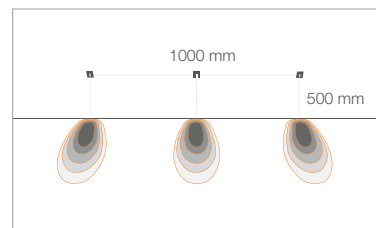
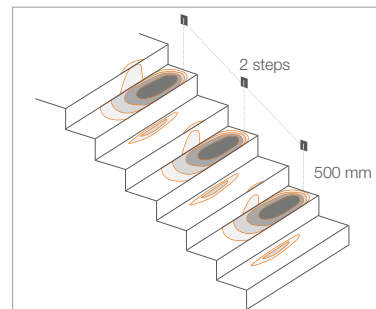



STEP INSIDE

INDOOR STEP LIGHTS ORIENTATION LIGHT

INDOOR



SQUARE COVER



ROUND COVER

SEMI-RECESSED



diffuse

2700K 3000K 4000K 5000K blue



STEP INSIDE 2.2 p. 706
max 2W max 500mA
constant current



STEP INSIDE 2.3 p. 706
max 2W max 500mA
constant current



STEP INSIDE 2.8 p. 707
2W 24Vdc
constant voltage



STEP INSIDE 2.9 p. 707
2W 24Vdc
constant voltage

OUTDOOR

STEP OUTSIDE p. 430

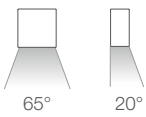
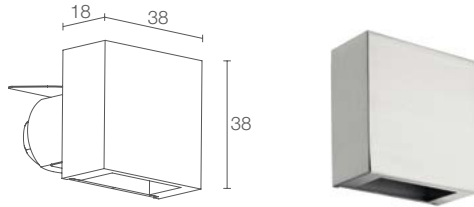

STEP INSIDE 2.2

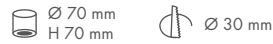

POWER / POWER SUPPLY CODE

max 2W max 500mA
SP2212 **D E** White
SP2212 **D C** Chrome
SP2212 **D S** Satin
SP2212 **D N** Black
SP2212 **D T** Cor-ten
SP2212 **D 4** Light ivory

LED COLOUR

F - 2700K
5 - 3000K
9 - 4000K
0 - 5000K
1 - blue

OPTICS

diffuse

LUMEN OUTPUT AT SOURCE 145 lm (3000K, 500mA)

DELIVERED LUMEN OUTPUT 35 lm (3000K, 500mA)

NO. AND TYPE OF LED 1 power LED
 1/4 ANSI BIN (white LED colour)
 50000h L90 B10 (Ta 25°C)

MATERIAL body and cover in aluminium
 screen in transparent extra-clear glass

POWER SUPPLY UNIT not included, see p. 904

POWER CABLES includes 1.5 m PVC cable
 FROR 2x0.35/0.35 Ø3.5 mm

WIRING series

MOUNTING semi-recessed (wall)

ACCESSORIES see p. 709

NOTES outdoor version: Step Outside 2.0, p. 432

PHOTOMETRIC DATA see p. 884

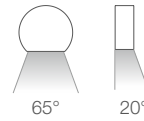
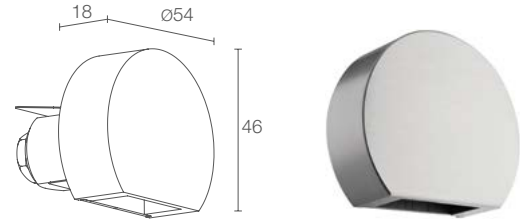

STEP INSIDE 2.3



max 2W max 500mA
SP2312 **D E** White
SP2312 **D C** Chrome
SP2312 **D S** Satin
SP2312 **D N** Black
SP2312 **D T** Cor-ten
SP2312 **D 4** Light ivory

F - 2700K
5 - 3000K
9 - 4000K
0 - 5000K
1 - blue

diffuse

LUMEN OUTPUT AT SOURCE 145 lm (3000K, 500mA)

DELIVERED LUMEN OUTPUT 35 lm (3000K, 500mA)

NO. AND TYPE OF LED 1 power LED
 1/4 ANSI BIN (white LED colour)
 50000h L90 B10 (Ta 25°C)

MATERIAL body and cover in aluminium
 screen in transparent extra-clear glass

POWER SUPPLY UNIT not included, see p. 904

POWER CABLES includes 1.5 m PVC cable
 FROR 2x0.35/0.35 Ø3.5 mm

WIRING series

MOUNTING semi-recessed (wall)

ACCESSORIES see p. 709

NOTES outdoor version: Step Outside 2.1, p. 432

PHOTOMETRIC DATA see p. 884

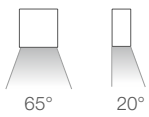
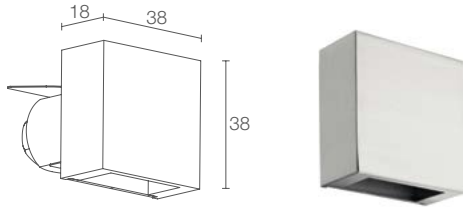

STEP INSIDE 2.8



2W 24Vdc
SP2800 **D E** White
SP2800 **D C** Chrome
SP2800 **D S** Satin
SP2800 **D N** Black
SP2800 **D T** Cor-ten
SP2800 **D 4** Light ivory

F - 2700K
5 - 3000K
9 - 4000K
0 - 5000K
1 - blue

diffuse

145 lm (3000K)

35 lm (3000K)

1 power LED
 1/4 ANSI BIN (white LED colour)
 50000h L90 B10 (Ta 25°C)

body and cover in aluminium
 screen in transparent extra-clear glass

not included, see p. 904

includes 1.5 m PVC cable
 FROR 2x0.35/0.35 Ø3.5 mm

parallel

semi-recessed (wall)

see p. 709

outdoor version: Step Outside 2.6, p. 433

see p. 884

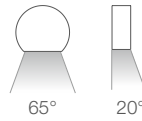
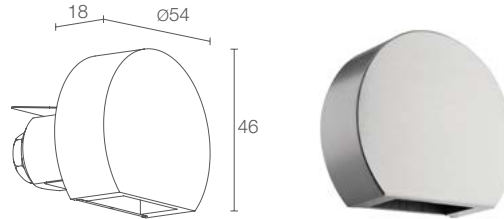

STEP INSIDE 2.9

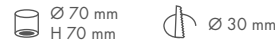

2W 24Vdc
SP2900 **D E** White
SP2900 **D C** Chrome
SP2900 **D S** Satin
SP2900 **D N** Black
SP2900 **D T** Cor-ten
SP2900 **D 4** Light ivory

F - 2700K
5 - 3000K
9 - 4000K
0 - 5000K
1 - blue

diffuse

145 lm (3000K)

35 lm (3000K)

1 power LED
 1/4 ANSI BIN (white LED colour)
 50000h L90 B10 (Ta 25°C)

body and cover in aluminium
 screen in transparent extra-clear glass

not included, see p. 904

includes 1.5 m PVC cable
 FROR 2x0.35/0.35 Ø3.5 mm

parallel

semi-recessed (wall)

see p. 709

outdoor version: Step Outside 2.7, p. 433

see p. 884



**POSITIONING
DIAGRAMS**

STEP INSIDE 2.2 / 2.3 / 2.8 / 2.9

D - Diffuse

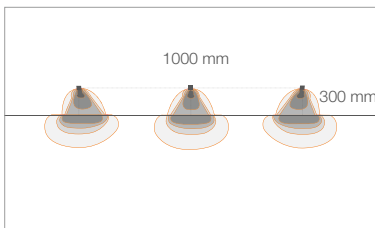
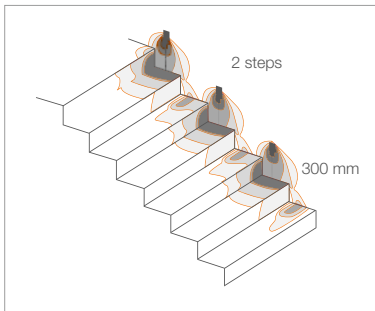

STANDARD FINISHES



White



Chrome



Satin



Black



Corten



Light ivory



ACCESSORIES AND POSITIONING DIAGRAMS

ACCESSORIES FOR INSTALLATION



WC0202
Outer casing

STEP INSIDE 2.3
3000K, 2W, white

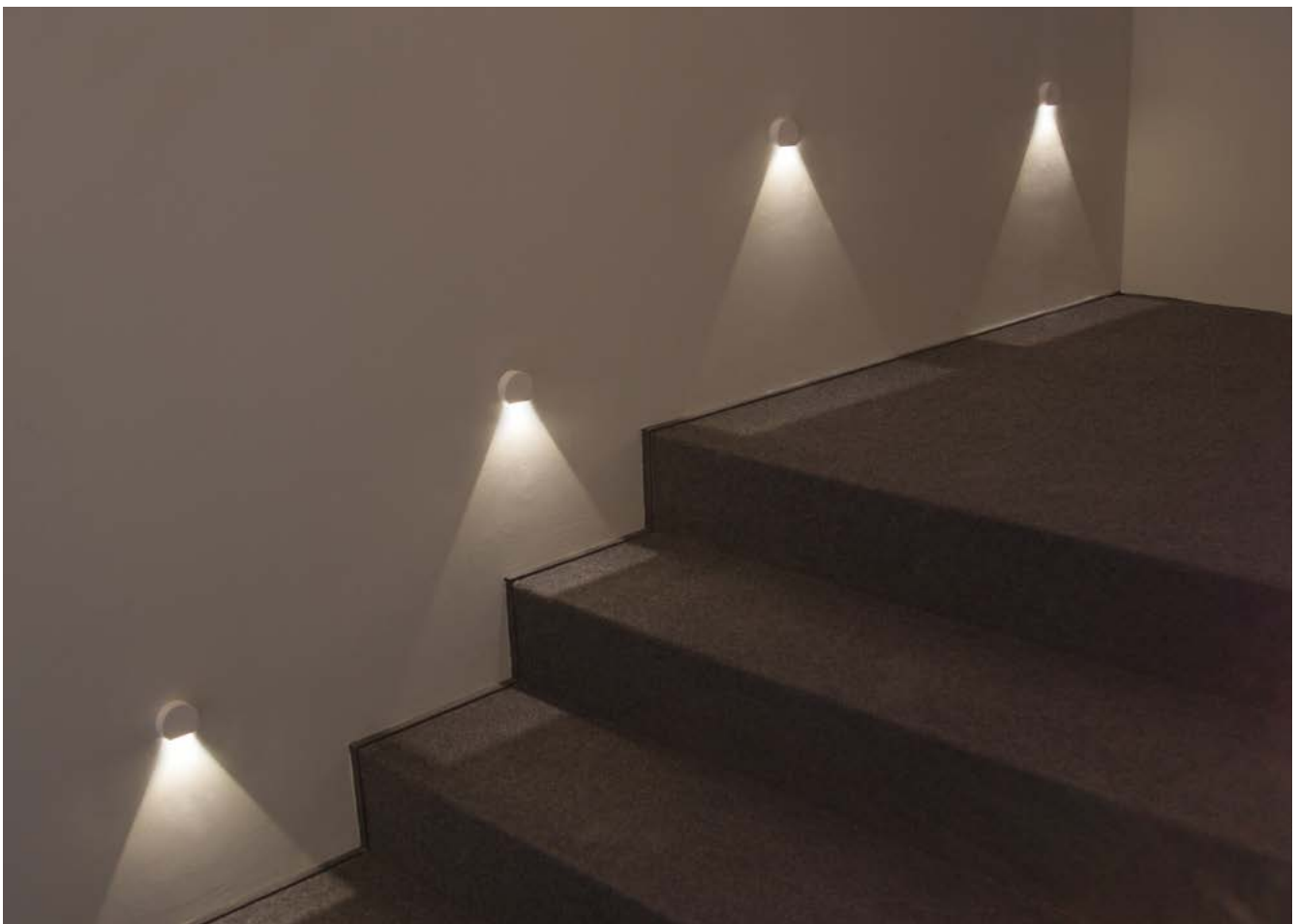



INDOOR UPLIGHT ORIENTATION LIGHT



SIMPLY 1.0

Ø 40 mm
H 10 mm

Ø 28 mm

CE EAC LED TECH III kg 0.03 IP44
A A+ A++ CASAMBI T max 40°C

POWER / POWER SUPPLY CODE

max 1W max 250mA
SM1011 **D C** Chrome
SM1011 **D P** Pearl chrome

LED COLOUR

F - 2700K
5 - 3000K
9 - 4000K
0 - 5000K
1 - blue

OPTICS

diffuse

LUMEN OUTPUT AT SOURCE 75 lm (3000K, 250mA)

DELIVERED LUMEN OUTPUT 37 lm (3000K, 250mA)

NO. AND TYPE OF LED 1 power LED
1/4 ANSI BIN (white LED colour)
50000h L95 B10 (Ta 25°C)

MATERIAL body and trim in anodized aluminium
screen in opal polycarbonate

POWER SUPPLY UNIT not included, see p. 904

POWER CABLES includes 2x0.30 m single-core cables

WIRING series

MOUNTING recessed (ceiling, wall, floor)

PHOTOMETRIC DATA see p. 873



Chrome



Pearl chrome

< **SIMPLY 1.0**
3000K, 1W, pearl chrome

Project and light planning by / DVDV Studio architetti
Photo by / Alessio Tamborini
Private residence, Milan, Italy



RECESSED FOR UNDERWATER APPLICATIONS

POOLS AND FOUNTAINS

MOBY p. 716 **1**

BRIGHT 316L p. 728 **2**



POOLS AND FOUNTAINS

BEAM

LIGHT COLOUR

MOBY see p. 716



OPTICS VERSION



BRIGHT 316L see p. 728



DIFFUSE VERSION

OPTICS VERSION

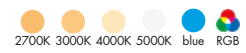



RECESSED FOR UNDERWATER APPLICATIONS

POWER SUPPLY

APPLIANCE CLASS

UNIQUE SELLING POINTS

CONSTANT VOLTAGE
(power supply unit not included)
24Vdc



glass cover with vitrified serigraphy
suitable for use in seawater

CONSTANT CURRENT
(power supply unit not included)
max 500mA (blue/white/RGB light)



CONSTANT VOLTAGE
(power supply unit not included)
24Vdc (blue/white light)

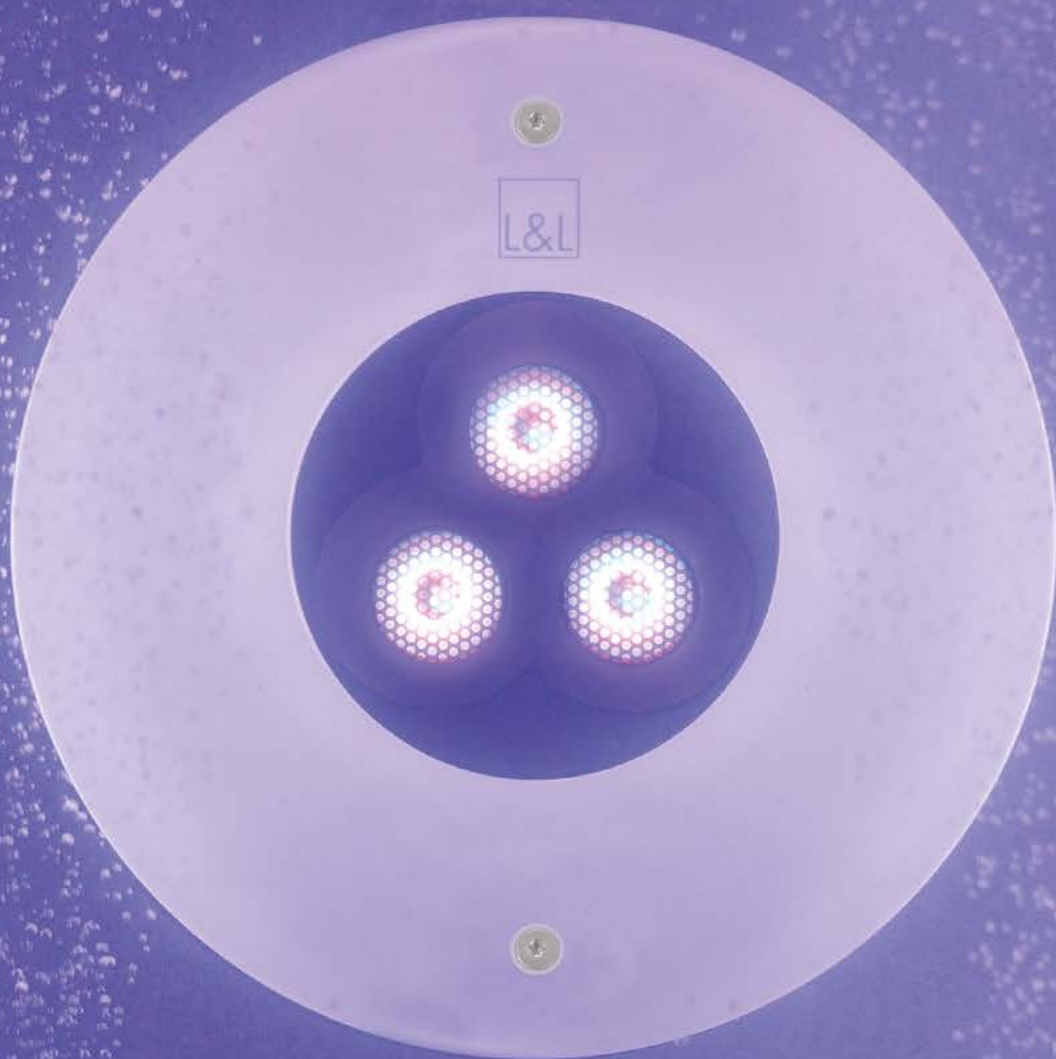



PERMANENT UNDERWATER RECESSED WHITE, RGBW AND CYAN LIGHTING SCENES IN POOLS AND FOUNTAINS

RECESSED

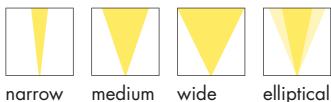

narrow medium wide elliptical

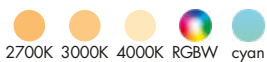

2700K 3000K 4000K RGBW cyan

9W 24Vdc
Ø180 mm

20W 24Vdc
Ø232 mm

30W 24Vdc
Ø270 mm

TRIM IN AISI 316L
STAINLESS STEEL



MOBY 1.0 p. 720



MOBY 2.0 p. 721



MOBY 3.0 p. 725

GLASS COVER WITH
VITRIFIED SERIGRAPHY



MOBY 1.1 p. 720



MOBY 2.1 p. 721



MOBY 3.1 p. 725

PROJECTORS

MOBY P p. 744



INSTALLATION IN SWIMMING POOLS
AND FOUNTAINS AT
GREAT DEPTHS: UP TO 10 M



BUILT-IN PROTECTION SYSTEMS:
IPS
INTELLIGENT PROTECTION SYSTEM



NTC
BUILT-IN TEMPERATURE SENSOR



IK10
THE GLASS'S THICKNESS OF UP TO 16 MM
GUARANTEES MAXIMUM IMPACT RESISTANCE



BODY IN THERMALLY CONDUCTIVE TECHNOPOLYMER FOR
EFFICIENT HEAT DISSIPATION AND TO PROTECT THE DEVICE
FROM THE HIGHLY CORROSIVE SUBSTANCES FOUND IN WATER:
CHLORINE (SWIMMING POOLS), SULPHUR (SPAS),
AND SODIUM CHLORIDE AND OTHER SALTS (SEAWATER).
SALT SPRAY TESTED (OVER 1500 HOURS)

THE HIGH-TRANSMITTANCE, TRANSPARENT, TEMPERED
EXTRA-CLEAR GLASS WITH VITRIFIED SERIGRAPHY
AND THE MIXING CHAMBER ENSURE CHROMATIC
UNIFORMITY OF THE WHITE, RGBW AND CYAN LIGHT



UNDERWATER PROJECTOR VERSION MOBY P, P. 744
(The maritime station, Genoa, Italy)

UNIQUE SELLING POINTS

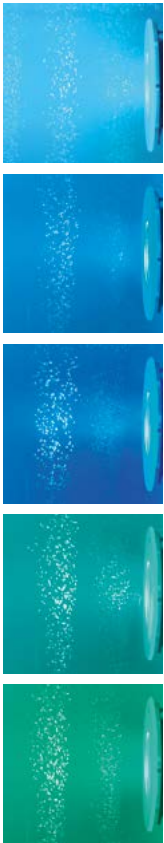

BY BLENDING THE GREEN AND BLUE, THE CYAN LED COLOUR CAN PRODUCE A RANGE OF COLOUR TONES, FROM TURQUOISE THROUGH AZURE TO AQUAMARINE



ANTI-GLARE
RECESSED OPTICS



INSTALLATION KIT SPECIFICALLY FOR SWIMMING POOLS WITH LINERS (MOBY WITH TRIM IN STAINLESS STEEL)



VERSION WITH TRIM IN PASSIVATED AND ELECTROPOLISHED AISI 316L STAINLESS STEEL, PRODUCED ENTIRELY ON A CNC LATHE: THE BEST CORROSION TREATMENT



VERSION WITH COVER IN GLASS WITH VITRIFIED SERIGRAPHY TO BLEND IN WITH THE UNDERWATER CLADDING: SUITABLE FOR USE IN SEAWATER, POOLS AND SPAS

MOBY 2.1

3000K, 20W, 31°x64°

Project by / arch. Rocco Valentini
Tenuta di Sipio, Ripa Teatina, Chieti, Italy

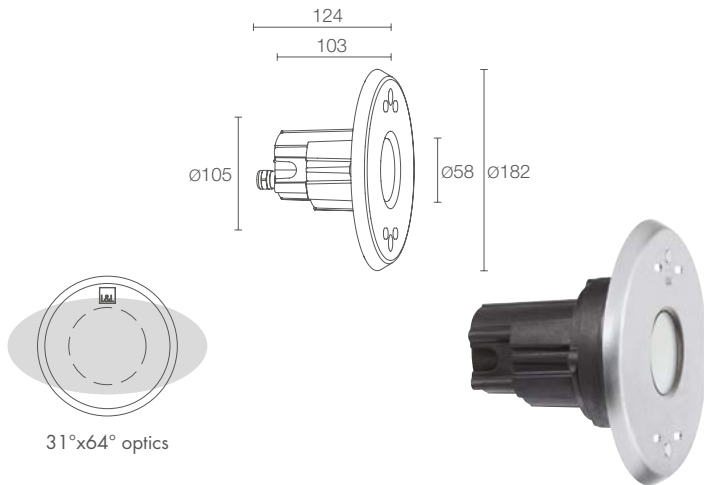

MOBY 1.0

MOBY 1.1

IP65 IP68 IK10 A A+ A++ NTC CASAMBI	
POWER / POWER SUPPLY CODE	9W 24Vdc MY1000 I Stainless steel
LED COLOUR	F - 2700K 5 - 3000K 9 - 4000K 7 - RGBW Y - shades of cyan
OPTICS	S - 22° M - 34° L - 62° W - 31°x64°
LUMEN OUTPUT AT SOURCE	507 lm (3000K) RGBW: 295 lm, R: 47 lm G: 85 lm B: 24 lm W: 139 lm (4000K) cyan: 260 lm
DELIVERED LUMEN OUTPUT	359 lm (3000K, 34°) RGBW: 208 lm, R: 33 lm G: 61 lm B: 16 lm W: 98 lm (4000K, 34°) cyan: 184 lm (34°)
NO. AND TYPE OF LED	1 power LED group, 2-step MacAdam RGBW: 1 RGBW power LED group cyan: 1 cyan power LED group 50000h L90 B10 (Ta 25°C)
MATERIAL	body in thermally conductive plastic trim in AISI 316L stainless steel screen in transparent, tempered extra-clear glass
POWER SUPPLY UNIT	not included, see p. 904 and 917
POWER CABLES	includes 5 m neoprene cable H05RN-F 2x1.00 Ø6.8 mm RGBW, cyan: includes 5 m FEP+RUB cable (equivalent to H05RN-F) 6x0.50 Ø6.3 mm
MOUNTING	recessed (wall) max depth 10 m
ACCESSORIES	see p. 727
NOTES	not suitable for use in salt water only suitable for underwater applications projector version: Moby P 1.0, p. 746
PHOTOMETRIC DATA	see p. 852

IP65 IP68 IK10 A A+ A++ NTC CASAMBI	
POWER / POWER SUPPLY CODE	9W 24Vdc MY1100 V Glass
LED COLOUR	F - 2700K 5 - 3000K 9 - 4000K 7 - RGBW Y - shades of cyan
OPTICS	S - 22° M - 34° L - 62° W - 31°x64°
LUMEN OUTPUT AT SOURCE	507 lm (3000K) RGBW: 295 lm, R: 47 lm G: 85 lm B: 24 lm W: 139 lm (4000K) cyan: 260 lm
DELIVERED LUMEN OUTPUT	359 lm (3000K, 34°) RGBW: 208 lm, R: 33 lm G: 61 lm B: 16 lm W: 98 lm (4000K, 34°) cyan: 184 lm (34°)
NO. AND TYPE OF LED	1 power LED group, 2-step MacAdam RGBW: 1 RGBW power LED group cyan: 1 cyan power LED group 50000h L90 B10 (Ta 25°C)
MATERIAL	body in thermally conductive plastic glass cover with vitrified serigraphy
POWER SUPPLY UNIT	not included, see p. 904 and 917
POWER CABLES	includes 5 m neoprene cable H05RN-F 2x1.00 Ø6.8 mm RGBW, cyan: includes 5 m FEP+RUB cable (equivalent to H05RN-F) 6x0.50 Ø6.3 mm
MOUNTING	recessed (wall) max depth 10 m
ACCESSORIES	see p. 727
NOTES	suitable for use in salt water only suitable for underwater applications projector version: Moby P 1.1, p. 746
PHOTOMETRIC DATA	see p. 852

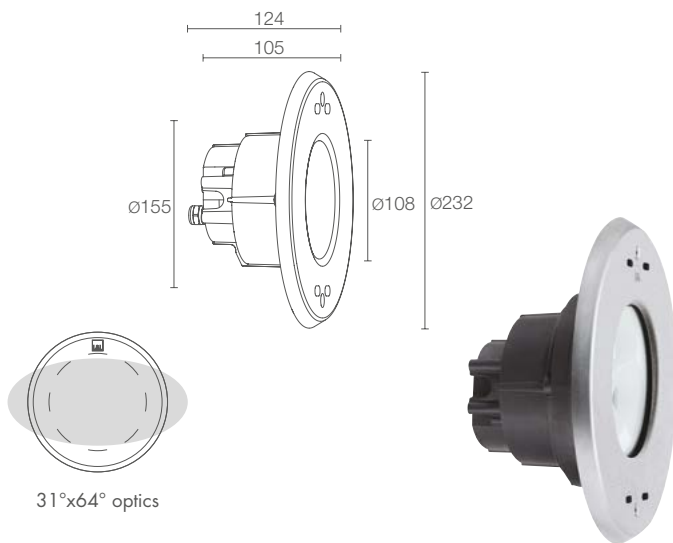

31°x64° optics



MOBY 2.0

IP65 IP68 IK10

A A+ A++ NTC CASAMBI

POWER / POWER SUPPLY CODE	20W 24Vdc MY2000 ■ ■ I Stainless steel
LED COLOUR	F - 2700K 5 - 3000K 9 - 4000K 7 - RGBW Y - shades of cyan
OPTICS	S - 22° M - 34° L - 62° W - 31°x64°

LUMEN OUTPUT AT SOURCE	1522 lm (3000K) RGBW: 884 lm, R: 138 lm G: 259 lm B: 69 lm W: 418 lm (4000K) cyan: 782 lm
DELIVERED LUMEN OUTPUT	1078 lm (3000K, 34°) RGBW: 626 lm, R: 97 lm G: 184 lm B: 48 lm W: 297 lm (4000K, 34°) cyan: 552 lm (34°)
NO. AND TYPE OF LED	3 power LED groups, 2-step MacAdam RGBW: 3 RGBW power LED groups cyan: 3 cyan power LED groups 50000h L90 B10 (Ta 25°C)
MATERIAL	body in thermally conductive plastic trim in AISI 316L stainless steel screen in transparent, tempered extra-clear glass
POWER SUPPLY UNIT	not included, see p. 904 and 917
POWER CABLES	includes 5 m neoprene cable H05RN-F 2x1.00 Ø6.8 mm RGBW, cyan: includes 5 m FEP+RUB cable (equivalent to H05RN-F) 6x0.50 Ø6.3 mm
MOUNTING	recessed (wall) max depth 10 m
ACCESSORIES	see p. 727
NOTES	not suitable for use in salt water only suitable for underwater applications projector version: Moby P 2.0, p. 747
PHOTOMETRIC DATA	see p. 852

MOBY 2.1

IP65 IP68 IK10

A A+ A++ NTC CASAMBI

POWER / POWER SUPPLY CODE	20W 24Vdc MY2100 ■ ■ V Glass
LED COLOUR	F - 2700K 5 - 3000K 9 - 4000K 7 - RGBW Y - shades of cyan
OPTICS	S - 22° M - 34° L - 62° W - 31°x64°

LUMEN OUTPUT AT SOURCE	1522 lm (3000K) RGBW: 884 lm, R: 138 lm G: 259 lm B: 69 lm W: 418 lm (4000K) cyan: 782 lm
DELIVERED LUMEN OUTPUT	1078 lm (3000K, 34°) RGBW: 626 lm, R: 97 lm G: 184 lm B: 48 lm W: 297 lm (4000K, 34°) cyan: 552 lm (34°)
NO. AND TYPE OF LED	3 power LED groups, 2-step MacAdam RGBW: 3 RGBW power LED groups cyan: 3 cyan power LED groups 50000h L90 B10 (Ta 25°C)
MATERIAL	body in thermally conductive plastic glass cover with vitrified serigraphy
POWER SUPPLY UNIT	not included, see p. 904 and 917
POWER CABLES	includes 5 m neoprene cable H05RN-F 2x1.00 Ø6.8 mm RGBW, cyan: includes 5 m FEP+RUB cable (equivalent to H05RN-F) 6x0.50 Ø6.3 mm
MOUNTING	recessed (wall) max depth 10 m
ACCESSORIES	see p. 727
NOTES	suitable for use in salt water only suitable for underwater applications projector version: Moby P 2.1, p. 747
PHOTOMETRIC DATA	see p. 852









MOBY 3.0

MOBY 3.1



IP65 IP68 IK10
A A+ A++ NTC CASAMBI



IP65 IP68 IK10
A A+ A++ NTC CASAMBI

POWER / POWER SUPPLY CODE	30W 24Vdc MY3000 I Stainless steel
LED COLOUR	F - 2700K 5 - 3000K 9 - 4000K 7 - RGBW Y - shades of cyan
OPTICS	S - 22° M - 34° L - 62° W - 31°x64°

POWER / POWER SUPPLY CODE	30W 24Vdc MY3100 V Glass
LED COLOUR	F - 2700K 5 - 3000K 9 - 4000K 7 - RGBW Y - shades of cyan
OPTICS	S - 22° M - 34° L - 62° W - 31°x64°

LUMEN OUTPUT AT SOURCE	2537 lm (3000K) RGBW: 1474 lm, R: 231 lm G: 432 lm B: 118 lm W: 693 lm (4000K) cyan: 1303 lm
DELIVERED LUMEN OUTPUT	1876 lm (3000K, 34°) RGBW: 1090 lm, R: 171 lm G: 319 lm B: 87 lm W: 513 lm (4000K, 34°) cyan: 961 lm (34°)
NO. AND TYPE OF LED	5 power LED groups, 2-step MacAdam RGBW: 5 RGBW power LED groups cyan: 5 cyan power LED groups 50000h L90 B10 (Ta 25°C)
MATERIAL	body in thermally conductive plastic trim in AISI 316L stainless steel screen in transparent, tempered extra-clear glass
POWER SUPPLY UNIT	not included, see p. 904 and 917
POWER CABLES	includes 5 m neoprene cable H05RN-F 2x1.00 Ø6.8 mm RGBW, cyan: includes 5 m FEP+RUB cable (equivalent to H05RN-F) 6x0.50 Ø6.3 mm
MOUNTING	recessed (wall) max depth 10 m
ACCESSORIES	see p. 727
NOTES	not suitable for use in salt water only suitable for underwater applications projector version: Moby P 3.0, p. 749
PHOTOMETRIC DATA	see p. 852





LUMEN OUTPUT AT SOURCE	2537 lm (3000K) RGBW: 1474 lm, R: 231 lm G: 432 lm B: 118 lm W: 693 lm (4000K) cyan: 1303 lm
DELIVERED LUMEN OUTPUT	1876 lm (3000K, 34°) RGBW: 1090 lm, R: 171 lm G: 319 lm B: 87 lm W: 513 lm (4000K, 34°) cyan: 961 lm (34°)
NO. AND TYPE OF LED	5 power LED groups, 2-step MacAdam RGBW: 5 RGBW power LED groups cyan: 5 cyan power LED groups 50000h L90 B10 (Ta 25°C)
MATERIAL	body in thermally conductive plastic glass cover with vitrified serigraphy
POWER SUPPLY UNIT	not included, see p. 904 and 917
POWER CABLES	includes 5 m neoprene cable H05RN-F 2x1.00 Ø6.8 mm RGBW, cyan: includes 5 m FEP+RUB cable (equivalent to H05RN-F) 6x0.50 Ø6.3 mm
MOUNTING	recessed (wall) max depth 10 m
ACCESSORIES	see p. 727
NOTES	suitable for use in salt water only suitable for underwater applications projector version: Moby P 3.1, p. 749
PHOTOMETRIC DATA	see p. 852

< **MOBY 2.1**
3000K, 20W, 31°x64°

Project by / arch. Rocco Valentini
Tenuta di Sipio, Ripa Teatina, Chieti, Italy



ACCESSORIES

	MOBY 1.0	MOBY 1.1	MOBY 2.0	MOBY 2.1	MOBY 3.0	MOBY 3.1
<p>ANTI-GLARE ACCESSORIES</p>  <p>Honeycomb louvre built into the lighting fixture order together with the lighting fixture</p>	WH0401	WH0401	WH0402	WH0402	WH0403	WH0403
<p>ACCESSORIES FOR INSTALLATION</p>  <p>Outer casing</p>  <p>Outer casing</p>  <p>Outer casing</p>  <p>Accessory for liner</p>	WC5201	WC5201	WC5202	WC5202	WC5203	WC5203
	WC5301		WC5302		WC5303	



< **BRIGHT 1.6 316L**
2700K, 2W, 40°
BRIGHT 2.6 316L
2700K, 6W, 38°
BRIGHT 1.6
2700K, 2W, 10°
Private residence
Côte d'Azur, France

RECESSED

UNDERWATER

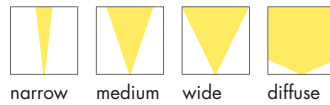

narrow medium wide diffuse

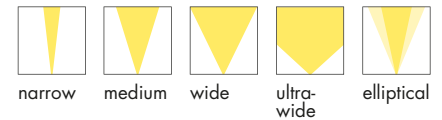

narrow medium wide ultra-wide elliptical

BLUE / WHITE LIGHT
CONSTANT CURRENT

Ø35 mm



BRIGHT 1.0 316L p. 730
max 2W max 500mA

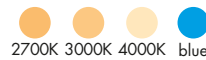

2700K 3000K 4000K blue

BLUE / WHITE LIGHT
CONSTANT VOLTAGE

Ø35 mm



BRIGHT 1.6 316L p. 731
2W 24Vdc



2700K 3000K 4000K blue

WHITE LIGHT
CONSTANT VOLTAGE
RGB LIGHT
CONSTANT CURRENT

Ø80 mm



BRIGHT 3.0 316L p. 736
7W / 9W 24Vdc
RGB: max 5W max 500mA



2700K 3000K 4000K RGB

BLUE/WHITE LIGHT
CONSTANT VOLTAGE
RGB LIGHT
CONSTANT CURRENT

UNDERWATER RECESSED LIGHTING FOR POOLS AND FOUNTAINS

OUTDOOR

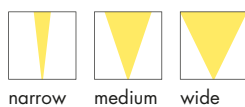
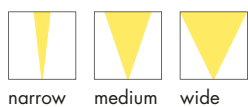

Ø133 mm



BRIGHT 2.0 316L p. 733
max 6W max 500mA



BRIGHT p. 90

Ø133 mm



BRIGHT 2.6 316L p. 733
6W 24Vdc

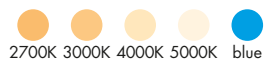

Ø201 mm



BRIGHT 5.0 316L p. 737
12W / 18W 24Vdc
RGB: max 18W max 500mA





^
BRIGHT 1.0 316L

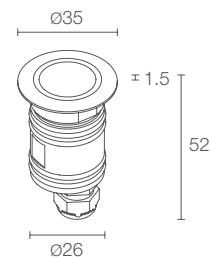



BRIGHT 1.0 316L

 Ø 30 mm

CE CB    kg 0.48

IP65 IP68 IK10

A A+ A++  CASAMBI  T max 50°C

POWER / POWER SUPPLY CODE	max 2W max 500mA CW1012  A I - 
LED COLOUR	F - 2700K 5 - 3000K 9 - 4000K 1 - blue
OPTICS	S - 10° M - 21° L - 43° D - diffuse
POWER CABLES	includes 5 m neoprene cable H05RN-F 2x0.35/0.75 Ø6.3 mm 2 - 10 m 3 - 15 m 4 - 20 m

LUMEN OUTPUT AT SOURCE	195 lm (3000K, 500mA)
DELIVERED LUMEN OUTPUT	127 lm (3000K, 500mA, 21°)
NO. AND TYPE OF LED	1 power LED 2-step MacAdam (white LED colour) 60000h L90 B10 (Ta 25°C)
MATERIAL	body and trim in AISI 316L stainless steel screen in transparent, tempered extra-clear glass (optics version) screen in acid-etched, tempered extra-clear glass (diffuse version)
POWER SUPPLY UNIT	not included, see p. 904
WIRING	series
MOUNTING	recessed (wall, ground) max depth 10 mm
ACCESSORIES	see p. 739
NOTES	also suitable for use out of water version with elliptical optics available on request
PHOTOMETRIC DATA	see p. 803

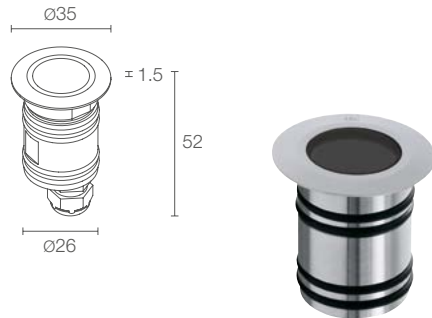

BRIGHT 1.6 316L



CE CB ENEC LED LIGHTS (II) kg 0.48

IP65 IP68 IK10

A A+ A++ IPS CASAMBI T max 50°C

2W 24Vdc

CW1600 I - ■

F - 2700K
5 - 3000K
9 - 4000K
1 - blue

S - 10°
M - 21°
L - 43°
D - diffuse

includes 5 m neoprene cable
 H05RN-F 2x0.35/0.75 Ø6.3 mm
2 - 10 m
3 - 15 m
4 - 20 m

195 lm (3000K)

127 lm (3000K, 21°)

1 power LED
 2-step MacAdam (white LED colour)
 60000h L90 B10 (Ta 25°C)

body and trim in AISI 316L stainless steel
 screen in transparent, tempered extra-clear glass
 (optics version)
 screen in acid-etched, tempered extra-clear glass
 (diffuse version)

not included, see p. 904

parallel

recessed (wall, ground)
 max depth 10 m

see p. 739

also suitable for use out of water
 version with elliptical optics available on request

see p. 803



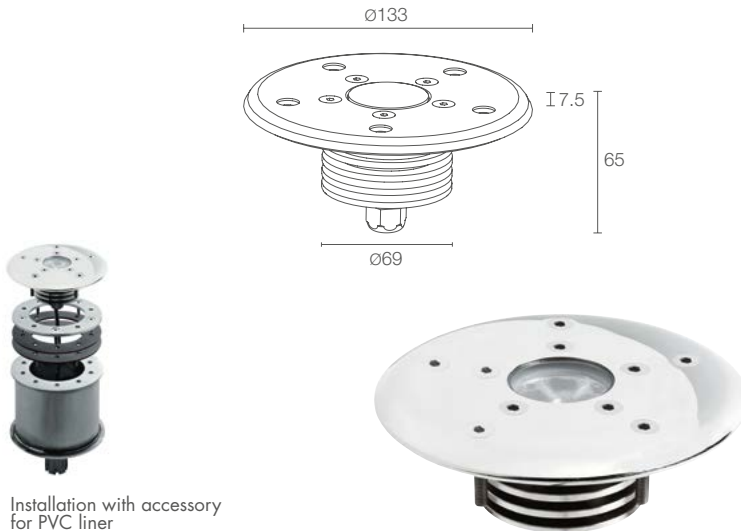

Installation with accessory for PVC liner

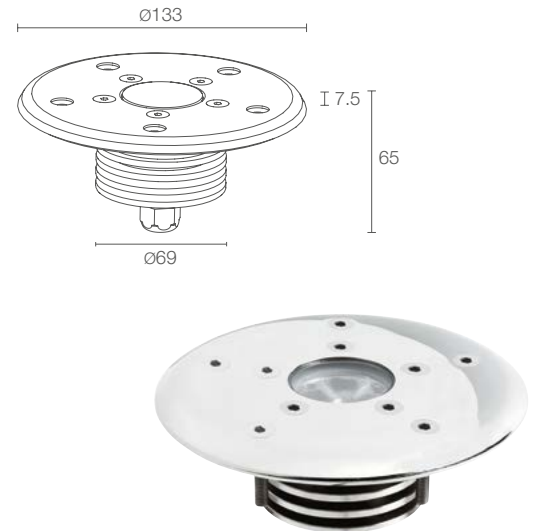

BRIGHT 2.0 316L



POWER / POWER SUPPLY CODE

max 6W max 500mA
CW2032 ■ ■ ■ A I - ■

LED COLOUR

F - 2700K
5 - 3000K
9 - 4000K
0 - 5000K
1 - blue
6 - RGB

OPTICS

S - 10°
M - 24°
L - 38°

POWER CABLES

includes 5 m neoprene cable
 H05RN-F 2x0.75/0.75 Ø6.3 mm
 RGB: includes 5 m FEP+RUB cable
 (equivalent to H05RN-F) 6x0.50/0.50 Ø6.3 mm
2 - 10 m
3 - 15 m
4 - 20 m

LUMEN OUTPUT AT SOURCE

436 lm (3000K, 500mA)
 RGB: 277 lm, R: 102 lm G: 132 lm
 B: 43 lm (500mA)

DELIVERED LUMEN OUTPUT

314 lm (3000K, 500mA, 24°)
 RGB: 198 lm, R: 73 lm G: 94 lm
 B: 31 lm (500mA, 24°)

NO. AND TYPE OF LED

3 power LEDs
 1/4 ANSI BIN (white LED colour)
 50000h L90 B10 (Ta 25°C)

MATERIAL

body and trim in AISI 316L stainless steel
 screen in transparent, tempered extra-clear glass

POWER SUPPLY UNIT

not included, see p. 904 and 917

WIRING

series

MOUNTING

recessed (wall, ground) max depth 10 m

ACCESSORIES

see p. 739

NOTES

also suitable for use out of water
 version with elliptical optics available on request

PHOTOMETRIC DATA

see p. 803

BRIGHT 2.6 316L



6W 24Vdc

CW2600 ■ ■ ■ I - ■

F - 2700K
5 - 3000K
9 - 4000K
0 - 5000K
1 - blue

S - 10°
M - 24°
L - 38°

includes 5 m neoprene cable
 H05RN-F 2x0.75/0.75 Ø6.3 mm
2 - 10 m
3 - 15 m
4 - 20 m

436 lm (3000K)

314 lm (3000K, 24°)

3 power LEDs
 1/4 ANSI BIN (white LED colour)
 50000h L90 B10 (Ta 25°C)

body and trim in AISI 316L stainless steel
 screen in transparent, tempered extra-clear glass

not included, see p. 904

parallel

recessed (wall, ground) max depth 10 m

see p. 739

also suitable for use out of water
 version with elliptical optics available on request

see p. 803





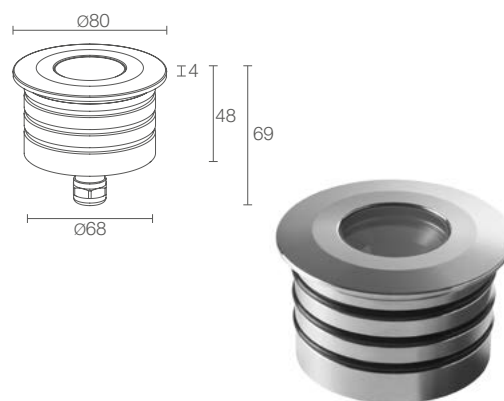

^
BRIGHT 3.0 316L

page 734

BRIGHT 2.6 316L
3000K, 6W, 24°

Light planning by / Lighting
Design International
The Edwardian Manchester,
A Radisson Collection Hotel
Manchester, United Kingdom

BRIGHT 3.0 316L



POWER / POWER SUPPLY CODE	7W 24Vdc white light CW30000 ■ ■ I - ■ 9W 24Vdc white light CW30010 ■ ■ I - ■ max 5W max 500mA RGB light CW3032 6 ■ ■ I - ■
LED COLOUR	F - 2700K 5 - 3000K 9 - 4000K
OPTICS	S - 11° M - 34° L - 45° K - 68° W - 13°x52° RGB: S - 20° M - 34° L - 45° W - 21°x42°
POWER CABLES	includes 5 m neoprene cable H05RN-F 2x1.00/1.00 Ø7.0 mm RGB: includes 5 m FEP+RUB cable (equivalent to H05RN-F) 6x0.50/0.50 Ø6.3 mm 2 - 10 m 3 - 15 m 4 - 20 m

LUMEN OUTPUT AT SOURCE	683 lm (3000K, 7W) 845 lm (3000K, 9W) RGB: 253 lm, R: 82 lm G: 114 lm B: 57 lm (500mA)
DELIVERED LUMEN OUTPUT	463 lm (3000K, 34°, 7W) 602 lm (3000K, 34°, 9W) RGB: 191 lm, R: 70 lm G: 90 lm B: 31 lm (500mA, 34°)
NO. AND TYPE OF LED	1 high-intensity power LED, 3-step MacAdam RGB: 3 power LEDs 50000h L90 B10 (Ta 25°C)
MATERIAL	body and trim in AISI 316L stainless steel screen in transparent, tempered extra-clear glass
POWER SUPPLY UNIT	not included, see p. 904 and 917
WIRING	parallel RGB: series
MOUNTING	recessed (wall, ground) max depth 10 mm
ACCESSORIES	see p. 739
NOTES	also suitable for use out of water the 7W version and the RGB version are also suitable for use out of water
PHOTOMETRIC DATA	see p. 804



Installation with accessory for PVC liner

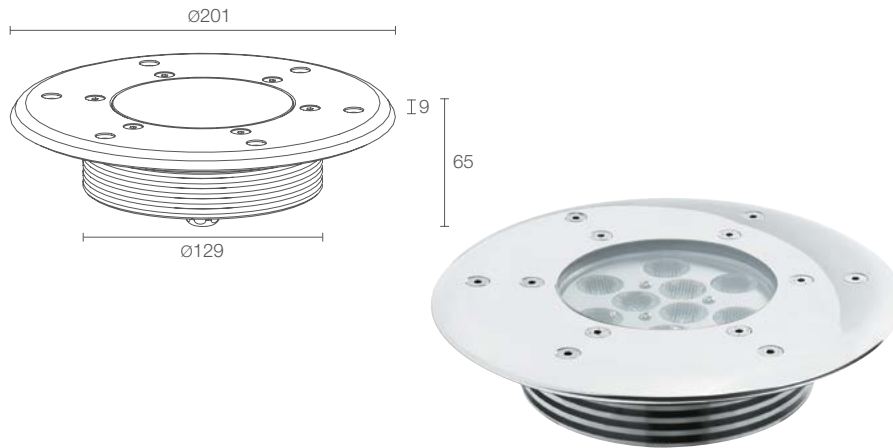

BRIGHT 5.0 316L



POWER / POWER SUPPLY CODE

12W 24Vdc blue/white light

CW5062 ■ ■ ■ A I - ■

18W 24Vdc blue/white light

CW5092 ■ ■ ■ A I - ■

max 18W max 500mA RGB light

CW5092 6 ■ ■ ■ A I - ■

LED COLOUR

F - 2700K

5 - 3000K

9 - 4000K

0 - 5000K

1 - blue

OPTICS

S - 10°

M - 20°

L - 40°

POWER CABLES

includes 5 m neoprene cable H05RN-F 2x0.75/0.75 Ø6.3 mm

RGB: includes 5 m FEP+RUB cable (equivalent to H05RN-F)

6x0.50/0.50 Ø6.3 mm

2 - 10 m

3 - 15 m

4 - 20 m

LUMEN OUTPUT AT SOURCE

872 lm (3000K, 12W)

1308 lm (3000K, 18W)

RGB: 785 lm, R: 288 lm G: 373 lm

B: 124 lm (500mA)

DELIVERED LUMEN OUTPUT

590 lm (3000K, 20°, 12W)

885 lm (3000K, 20°, 18W)

RGB: 561 lm, R: 206 lm G: 266 lm

B: 89 lm (500mA, 20°)

NO. AND TYPE OF LED

6, 9 power LEDs, 1/4 ANSI BIN (white LED colour)

RGB: 9 power LEDs

50000h L90 B10 (Ta 25°C)

MATERIAL

body and trim in AISI 316L stainless steel

screen in transparent, tempered extra-clear glass

POWER SUPPLY UNIT

not included, see p. 904 and 917

WIRING

parallel

RGB: series

MOUNTING

recessed (wall, ground)

max depth 10 m

ACCESSORIES

see p. 739

NOTES

also suitable for use out of water







version with elliptical optics available on request

PHOTOMETRIC DATA

see p. 804



ACCESSORIES

	BRIGHT 1.0 316L	BRIGHT 1.6 316L	BRIGHT 2.0 316L	BRIGHT 2.6 316L	BRIGHT 3.0 316L	BRIGHT 5.0 316L
<p>ANTI-GLARE ACCESSORIES</p>  <p>Honeycomb louvre built into the lighting fixture order together with the lighting fixture</p>					WH0201	
<p>ACCESSORIES FOR INSTALLATION</p>  <p>Outer casing</p>  <p>Outer casing</p>  <p>Outer casing</p>  <p>Outer casing</p>  <p>Outer casing</p>  <p>Accessory for PVC liner</p>	WC5003	WC5003		WC5002	WC5002	
					WC5004	
					WC5006	
						WC5005
			WC5102	WC5102		WC5105

for spare parts, see p. 932

< **BRIGHT 2.6 316L**
2700K, 6W, 24°

BRIGHT 1.6
2700K, 2W, 10°

Private residence, Côte d'Azur, France





PROJECTORS FOR UNDERWATER APPLICATIONS

FOUNTAINS

MOBY P p. 744 **1**

SPOT 316L p. 752 **2**

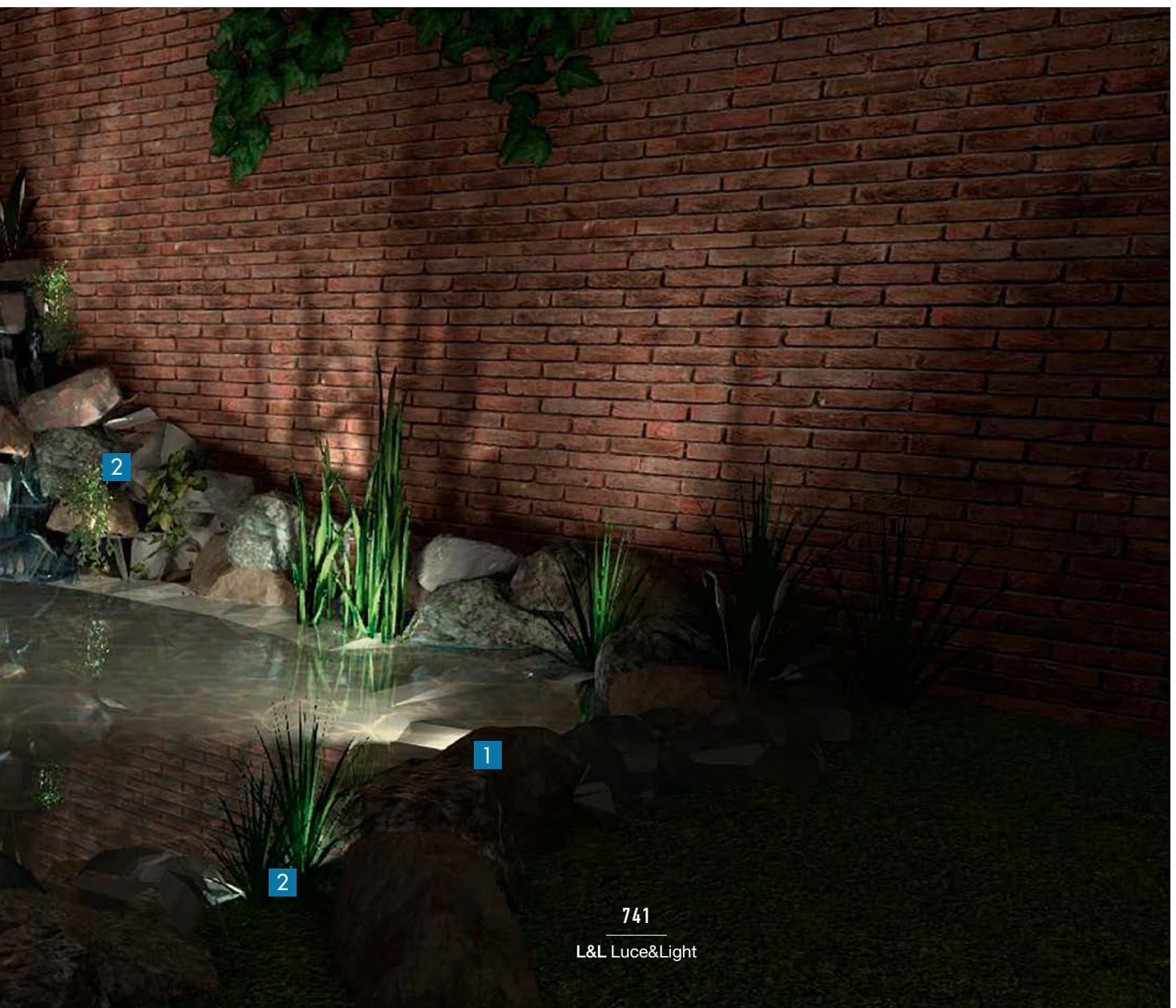

FOUNTAINS

LIGHT COLOUR

POWER SUPPLY

MOBY P see p. 744



CONSTANT VOLTAGE
(power supply unit not included)
24Vdc

SPOT 316L see p. 752



CONSTANT CURRENT
(power supply unit not included)
max 500mA (blue/white/RGB light)

CONSTANT VOLTAGE
(power supply unit not included)
24Vdc (blue/white light)



PROJECTORS FOR UNDERWATER APPLICATIONS

APPLIANCE CLASS**UNIQUE SELLING POINTS**

glass cover with vitrified serigraphy



also suitable for use out of water





PERMANENT UNDERWATER PROJECTORS WHITE, RGBW AND CYAN LIGHTING SCENES IN FOUNTAINS

PROJECTORS

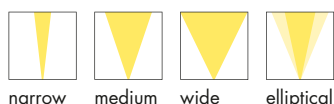

narrow medium wide elliptical

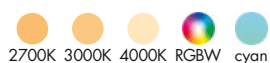

2700K 3000K 4000K RGBW cyan

9W 24Vdc
Ø105 mm

20W 24Vdc
Ø155 mm

30W 24Vdc
Ø193 mm

TRIM IN AISI 316L
STAINLESS STEEL



MOBY P 1.0 p. 746



MOBY P 2.0 p. 747



MOBY P 3.0 p. 749

GLASS COVER
WITH VITRIFIED SERIGRAPHY



MOBY P 1.1 p. 746



MOBY P 2.1 p. 747



MOBY P 3.1 p. 749

RECESSED

MOBY p. 716

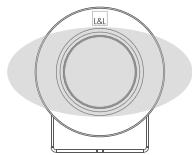

31°x64° optics



MOBY P 1.0



POWER / POWER SUPPLY CODE	9W 24Vdc MP1000 ■ ■ I Stainless steel
LED COLOUR	F - 2700K 5 - 3000K 9 - 4000K 7 - RGBW Y - shades of cyan
OPTICS	S - 22° M - 34° L - 62° W - 31°x64°

LUMEN OUTPUT AT SOURCE	507 lm (3000K) RGBW: 295 lm, R: 47 lm G: 85 lm B: 24 lm W: 139 lm (4000K) cyan: 260 lm
DELIVERED LUMEN OUTPUT	359 lm (3000K, 34°) RGBW: 208 lm, R: 33 lm G: 61 lm B: 16 lm W: 98 lm (4000K, 34°) cyan: 184 lm (34°)
NO. AND TYPE OF LED	1 power LED group, 2-step MacAdam RGBW: 1 RGBW LED group cyan: 1 cyan power LED group 50000h L90 B10 (Ta 25°C)
MATERIAL	body in thermally conductive plastic trim in AISI 316L stainless steel bracket in AISI 316L stainless steel screen in transparent, tempered extra-clear glass
POWER SUPPLY UNIT	not included, see p. 904 and 917
POWER CABLES	includes 5 m neoprene cable H05RN-F 2x1.00 Ø6.8 mm RGBW, cyan: includes 5 m FEP+RUB cable (equivalent to H05RN-F) 6x0.50 Ø6.3 mm
MOUNTING	surface mounted (wall, ground) max depth 10 m
ACCESSORIES	see p. 751
NOTES	not suitable for use in salt water only suitable for underwater applications recessed version: Moby 1.0, p. 720
PHOTOMETRIC DATA	see p. 852



MOBY P 1.1



POWER / POWER SUPPLY CODE	9W 24Vdc MP1100 ■ ■ V Glass
LED COLOUR	F - 2700K 5 - 3000K 9 - 4000K 7 - RGBW Y - shades of cyan
OPTICS	S - 22° M - 34° L - 62° W - 31°x64°

LUMEN OUTPUT AT SOURCE	507 lm (3000K) RGBW: 295 lm, R: 47 lm G: 85 lm B: 24 lm W: 139 lm (4000K) cyan: 260 lm
DELIVERED LUMEN OUTPUT	359 lm (3000K, 34°) RGBW: 208 lm, R: 33 lm G: 61 lm B: 16 lm W: 98 lm (4000K, 34°) cyan: 184 lm (34°)
NO. AND TYPE OF LED	1 power LED group, 2-step MacAdam RGBW: 1 RGBW LED group cyan: 1 cyan power LED group 50000h L90 B10 (Ta 25°C)
MATERIAL	body in thermally conductive plastic bracket in AISI 316L stainless steel glass cover with vitrified serigraphy
POWER SUPPLY UNIT	not included, see p. 904 and 917
POWER CABLES	includes 5 m neoprene cable H05RN-F 2x1.00 Ø6.8 mm RGBW, cyan: includes 5 m FEP+RUB cable (equivalent to H05RN-F) 6x0.50 Ø6.3 mm
MOUNTING	surface mounted (wall, ground) max depth 10 m
ACCESSORIES	see p. 751
NOTES	not suitable for use in salt water only suitable for underwater applications recessed version: Moby 1.1, p. 720
PHOTOMETRIC DATA	see p. 852

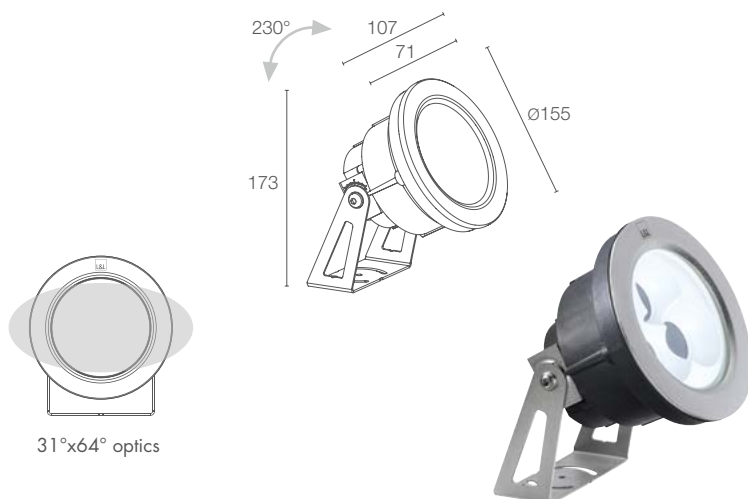

MOBY P 2.0



POWER / POWER SUPPLY CODE	20W 24Vdc MP2000 ■ ■ I Stainless steel
LED COLOUR	F - 2700K 5 - 3000K 9 - 4000K 7 - RGBW Y - shades of cyan
OPTICS	S - 22° M - 34° L - 62° W - 31°x64°



MOBY P 2.1



POWER / POWER SUPPLY CODE	20W 24Vdc MP2100 ■ ■ V Glass
LED COLOUR	F - 2700K 5 - 3000K 9 - 4000K 7 - RGBW Y - shades of cyan
OPTICS	S - 22° M - 34° L - 62° W - 31°x64°

LUMEN OUTPUT AT SOURCE	1522 lm (3000K) RGBW: 884 lm, R: 138 lm G: 259 lm B: 69 lm W: 418 lm (4000K) cyan: 782 lm
DELIVERED LUMEN OUTPUT	1078 lm (3000K, 34°) RGBW: 626 lm, R: 97 lm G: 184 lm B: 48 lm W: 297 lm (4000K, 34°) cyan: 552 lm (34°)
NO. AND TYPE OF LED	3 power LED groups, 2-step MacAdam RGBW: 3 RGBW LED groups cyan: 3 cyan power LED groups 50000h L90 B10 (Ta 25°C)
MATERIAL	body in thermally conductive plastic trim in AISI 316L stainless steel bracket in AISI 316L stainless steel screen in transparent, tempered extra-clear glass
POWER SUPPLY UNIT	not included, see p. 904 and 917
POWER CABLES	includes 5 m neoprene cable H05RN-F 2x1.00 Ø6.8 mm RGBW, cyan: includes 5 m FEP+RUB cable (equivalent to H05RN-F) 6x0.50 Ø6.3 mm
MOUNTING	surface mounted (wall, ground) max depth 10 m
ACCESSORIES	see p. 751
NOTES	not suitable for use in salt water only suitable for underwater applications recessed version: Moby 2.0, p. 721
PHOTOMETRIC DATA	see p. 852

LUMEN OUTPUT AT SOURCE	1522 lm (3000K) RGBW: 884 lm, R: 138 lm G: 259 lm B: 69 lm W: 418 lm (4000K) cyan: 782 lm
DELIVERED LUMEN OUTPUT	1078 lm (3000K, 34°) RGBW: 626 lm, R: 97 lm G: 184 lm B: 48 lm W: 297 lm (4000K, 34°) cyan: 552 lm (34°)
NO. AND TYPE OF LED	3 power LED groups, 2-step MacAdam RGBW: 3 RGBW LED groups cyan: 3 cyan power LED groups 50000h L90 B10 (Ta 25°C)
MATERIAL	body in thermally conductive plastic bracket in AISI 316L stainless steel glass cover with vitrified serigraphy
POWER SUPPLY UNIT	not included, see p. 904 and 917
POWER CABLES	includes 5 m neoprene cable H05RN-F 2x1.00 Ø6.8 mm RGBW, cyan: includes 5 m FEP+RUB cable (equivalent to H05RN-F) 6x0.50 Ø6.3 mm
MOUNTING	surface mounted (wall, ground) max depth 10 m
ACCESSORIES	see p. 751
NOTES	not suitable for use in salt water only suitable for underwater applications recessed version: Moby 2.1, p. 721
PHOTOMETRIC DATA	see p. 852



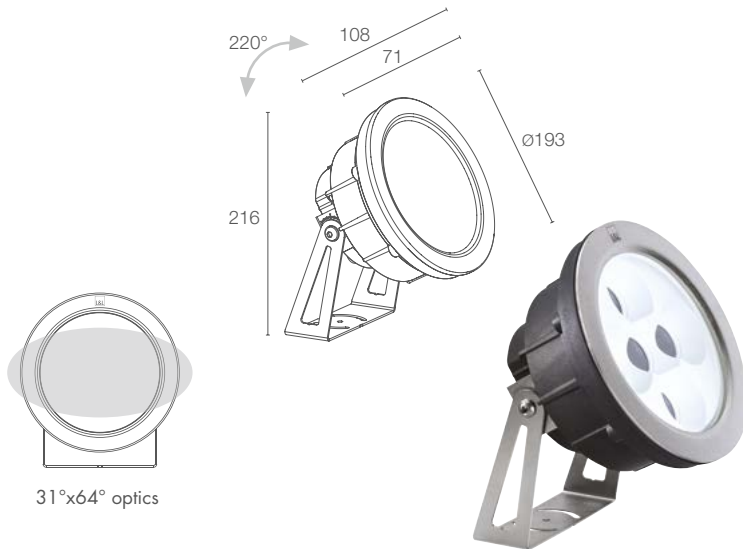

MOBY P 3.0

MOBY P 3.1



POWER / POWER SUPPLY CODE	30W 24Vdc MP3000 ■ ■ ■ Stainless steel
LED COLOUR	F - 2700K 5 - 3000K 9 - 4000K 7 - RGBW Y - shades of cyan
OPTICS	S - 22° M - 34° L - 62° W - 31°x64°

POWER / POWER SUPPLY CODE	30W 24Vdc MP3100 ■ ■ ■ V Glass
LED COLOUR	F - 2700K 5 - 3000K 9 - 4000K 7 - RGBW Y - shades of cyan
OPTICS	S - 22° M - 34° L - 62° W - 31°x64°

LUMEN OUTPUT AT SOURCE	2537 lm (3000K) RGBW: 1474 lm, R: 231 lm G: 432 lm B: 118 lm W: 693 lm (4000K) cyan: 1303 lm
DELIVERED LUMEN OUTPUT	1876 lm (3000K, 34°) RGBW: 1090 lm, R: 171 lm G: 319 lm B: 87 lm W: 513 lm (4000K, 34°) cyan: 961 lm (34°)
NO. AND TYPE OF LED	5 power LED groups, 2-step MacAdam RGBW: 5 RGBW LED groups cyan: 5 cyan power LED groups 50000h L90 B10 (Ta 25°C)
MATERIAL	body in thermally conductive plastic trim in AISI 316L stainless steel bracket in AISI 316L stainless steel screen in transparent, tempered extra-clear glass
POWER SUPPLY UNIT	not included, see p. 904 and 917
POWER CABLES	includes 5 m neoprene cable H05RN-F 2x1.00 Ø6.8 mm RGBW, cyan: includes 5 m FEP+RUB cable (equivalent to H05RN-F) 6x0.50 Ø6.3 mm
MOUNTING	surface mounted (wall, ground) max depth 10 m
ACCESSORIES	see p. 751
NOTES	not suitable for use in salt water only suitable for underwater applications recessed version: Moby 3.0, p. 725
PHOTOMETRIC DATA	see p. 852

LUMEN OUTPUT AT SOURCE	2537 lm (3000K) RGBW: 1474 lm, R: 231 lm G: 432 lm B: 118 lm W: 693 lm (4000K) cyan: 1303 lm
DELIVERED LUMEN OUTPUT	1876 lm (3000K, 34°) RGBW: 1090 lm, R: 171 lm G: 319 lm B: 87 lm W: 513 lm (4000K, 34°) cyan: 961 lm (34°)
NO. AND TYPE OF LED	5 power LED groups, 2-step MacAdam RGBW: 5 RGBW LED groups cyan: 5 cyan power LED groups 50000h L90 B10 (Ta 25°C)
MATERIAL	body in thermally conductive plastic bracket in AISI 316L stainless steel cover in glass with vitrified serigraphy
POWER SUPPLY UNIT	not included, see p. 904 and 917
POWER CABLES	includes 5 m neoprene cable H05RN-F 2x1.00 Ø6.8 mm RGBW, cyan: includes 5 m FEP+RUB cable (equivalent to H05RN-F) 6x0.50 Ø6.3 mm
MOUNTING	surface mounted (wall, ground) max depth 10 m
ACCESSORIES	see p. 751
NOTES	not suitable for use in salt water only suitable for underwater applications recessed version: Moby 3.1, p. 725
PHOTOMETRIC DATA	see p. 852

- < **MOBY P 1.1**
RGBW, 9W, 31°x64°
- MOBY P 2.1**
RGBW, 20W, 62°

Light planning by / Studio Luce, Gruppo Sacchi
Photo by / Alessio Tamborini
The maritime station, Genoa, Italy

▼
MOBY P 1.0
RGBW, 9W, 34°
MOBY P 2.0
RGBW, 20W, 34°
MOBY P 3.0
RGBW, 30W, 34°

Monumental fountain
Silvi Marina, Teramo, Italy





ACCESSORIES

	MOBY P 1.0	MOBY P 1.1	MOBY P 2.0	MOBY P 2.1	MOBY P 3.0	MOBY P 3.1
ANTI-GLARE ACCESSORIES  Honeycomb louvre built into the lighting fixture order together with the lighting fixture	WH0401	WH0401	WH0402	WH0402	WH0403	WH0403







OUTDOOR AND UNDERWATER PROJECTORS FOUNTAINS AND HARSH ENVIRONMENTS



narrow medium wide



2700K 3000K 4000K 5000K blue

UNDERWATER

COVER
Ø30 mm

COVER
Ø69 mm

COVER
Ø124 mm

CONSTANT CURRENT



SPOT 1.0 316L p. 754
max 2W max 500mA



SPOT 2.0 316L p. 755
max 6W max 500mA

CONSTANT VOLTAGE



SPOT 1.6 316L p. 754
2W 24Vdc



SPOT 2.6 316L p. 755
6W 24Vdc

WHITE AND BLUE LIGHT:
CONSTANT VOLTAGE

RGB LIGHT:
CONSTANT CURRENT



SPOT 3.0 316L p. 757
12W/18W 24Vdc
RGB: max 18W max 500mA

OUTDOOR

SPOT p. 272

< SPOT 3.0 316L
3000K, 12W, 40°

Light planning by / ing. Paolo Saracino
and ing. Donato Saracino
Grotta Zinzulusa, Castro Marina, Lecce, Italy

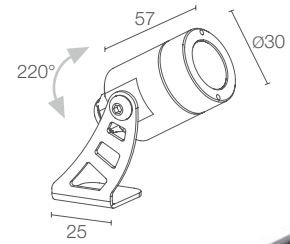
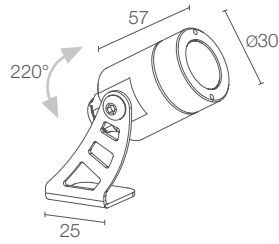
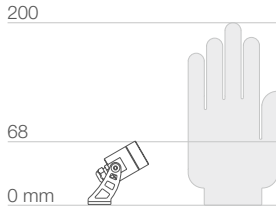

SPOT 1.0 316L



POWER / POWER SUPPLY CODE

max 2W max 500mA
PW1012 ■ ■ ■ A I - ■

LED COLOUR

F - 2700K
5 - 3000K
9 - 4000K
0 - 5000K
1 - blue

OPTICS

S - 10°
M - 20°
L - 40°

POWER CABLES

includes 5 m neoprene cable
 H05RN-F 2x0.35/0.75 Ø6.3 mm
2 - 10 m
3 - 15 m
4 - 20 m

LUMEN OUTPUT AT SOURCE 145 lm (3000K, 500mA)

DELIVERED LUMEN OUTPUT 88 lm (3000K, 500mA, 20°)

NO. AND TYPE OF LED 1 power LED
 1/4 ANSI BIN (white LED colour)
 50000h L90 B10 (Ta 25°C)

MATERIAL body and trim in AISI 316L stainless steel
 screen in transparent, tempered glass

POWER SUPPLY UNIT not included, see p. 904

WIRING series

MOUNTING surface mounted (ceiling, wall, ground, spike)
 max depth 10 m

ACCESSORIES see p. 759

NOTES also suitable for use out of water
 version with elliptical optics available on request

PHOTOMETRIC DATA see p. 883

SPOT 1.6 316L



2W 24Vdc
PW1600 ■ ■ ■ I - ■

F - 2700K
5 - 3000K
9 - 4000K
0 - 5000K
1 - blue

S - 10°
M - 20°
L - 40°

includes 5 m neoprene cable
 H05RN-F 2x0.35/0.75 Ø6.3 mm
2 - 10 m
3 - 15 m
4 - 20 m

145 lm (3000K)

88 lm (3000K, 20°)

1 power LED
 1/4 ANSI BIN (white LED colour)
 50000h L90 B10 (Ta 25°C)

body and trim in AISI 316L stainless steel
 screen in transparent, tempered glass

not included, see p. 904

parallel

surface mounted (ceiling, wall, ground, spike)
 max depth 10 m

see p. 759

also suitable for use out of water
 version with elliptical optics available on request

see p. 883

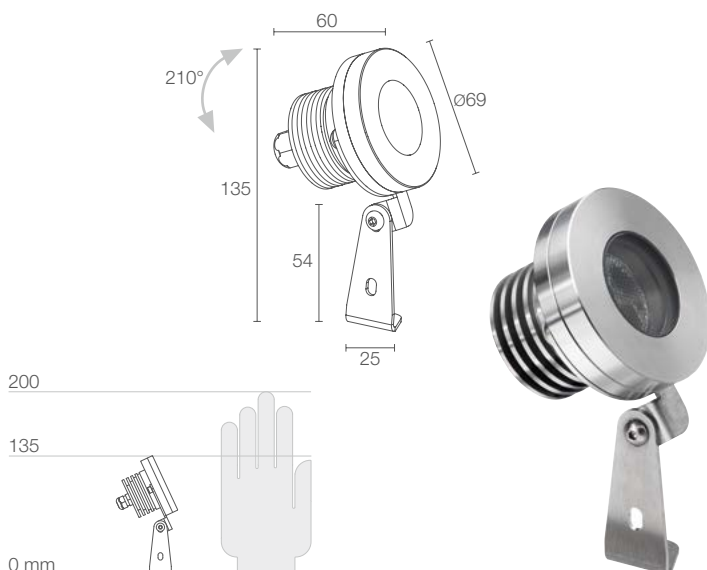

SPOT 2.0 316L



POWER / POWER SUPPLY CODE	max 6W max 500mA PW2032 ■ ■ ■ A I - ■
LED COLOUR	F - 2700K 5 - 3000K 9 - 4000K 0 - 5000K 1 - blue 6 - RGB
OPTICS	S - 10° M - 24° L - 38°
POWER CABLES	includes 5 m neoprene cable H05RN-F 2x0.75/0.75 Ø6.3 mm RGB: includes 5 m FEP+RUB cable (equivalent to H05RN-F) 6x0.50/0.50 Ø6.3 mm 2 - 10 m 3 - 15 m 4 - 20 m

LUMEN OUTPUT AT SOURCE	436 lm (3000K, 500mA) RGB: 277 lm, R: 102 lm G: 132 lm B: 43 lm (500mA)
DELIVERED LUMEN OUTPUT	314 lm (3000K, 500mA, 24°) RGB: 198 lm, R: 73 lm G: 94 lm B: 31 lm (500mA, 24°)
NO. AND TYPE OF LED	3 power LEDs 1/4 ANSI BIN (white LED colour) 50000h L90 B10 (Ta 25°C)
MATERIAL	body and trim in AISI 316L stainless steel screen in transparent, tempered extra-clear glass
POWER SUPPLY UNIT	not included, see p. 904 and 917
WIRING	series
MOUNTING	surface mounted (ceiling, wall, ground, spike) max depth 10 m
ACCESSORIES	see p. 759
NOTES	also suitable for use out of water version with elliptical optics available on request
PHOTOMETRIC DATA	see p. 883

SPOT 2.6 316L



POWER / POWER SUPPLY CODE	6W 24Vdc PW2600 ■ ■ ■ I - ■
LED COLOUR	F - 2700K 5 - 3000K 9 - 4000K 0 - 5000K 1 - blue
OPTICS	S - 10° M - 24° L - 38°
POWER CABLES	includes 5 m neoprene cable H05RN-F 2x0.75/0.75 Ø6.3 mm 2 - 10 m 3 - 15 m 4 - 20 m

LUMEN OUTPUT AT SOURCE	436 lm (3000K)
DELIVERED LUMEN OUTPUT	314 lm (3000K, 24°)
NO. AND TYPE OF LED	3 power LEDs 1/4 ANSI BIN (white LED colour) 50000h L90 B10 (Ta 25°C)
MATERIAL	body and trim in AISI 316L stainless steel screen in transparent, tempered extra-clear glass
POWER SUPPLY UNIT	not included, see p. 904
WIRING	parallel
MOUNTING	surface mounted (ceiling, wall, ground, spike) max depth 10 m
ACCESSORIES	see p. 759
NOTES	also suitable for use out of water version with elliptical optics available on request
PHOTOMETRIC DATA	see p. 883



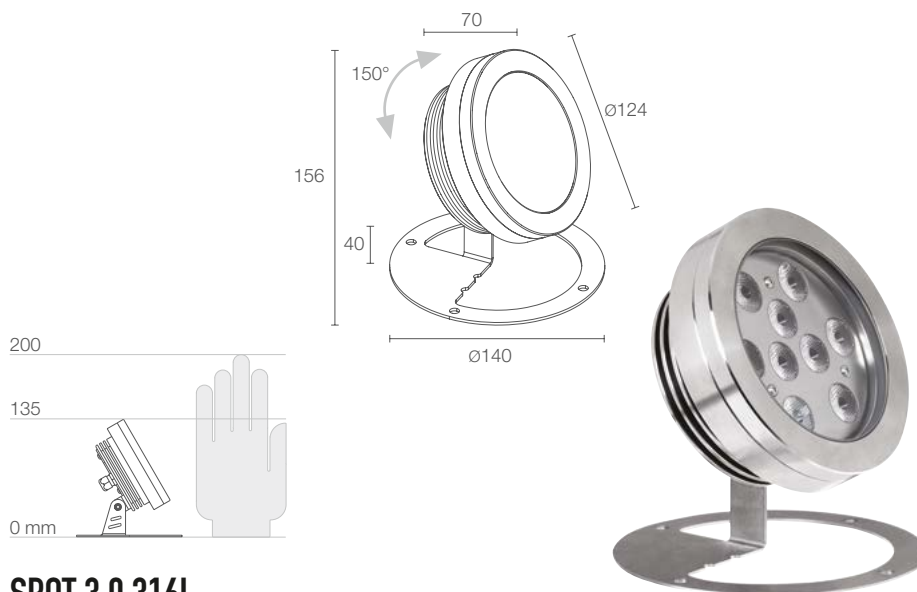

SPOT 3.0 316L



POWER / POWER SUPPLY CODE

12W 24Vdc blue/white light
PW3062 ■ ■ ■ A I - ■

18W 24Vdc blue/white light
PW3092 ■ ■ ■ A I - ■

max 18W max 500mA RGB light
PW3092 6 ■ ■ A I - ■

■ LED COLOUR	F - 2700K 5 - 3000K 9 - 4000K 0 - 5000K 1 - blue
■ OPTICS	S - 10° M - 20° L - 40°
■ POWER CABLES	includes 5 m neoprene cable H05RN-F 2x0.75/0.75 Ø6.3 mm RGB: includes 5 m FEP+RUB cable (equivalent to H05RN-F) 6x0.50/0.50 Ø6.3 mm 2 - 10 m 3 - 15 m 4 - 20 m

LUMEN OUTPUT AT SOURCE	872 lm (3000K, 12W) 1308 lm (3000K, 18W) RGB: 791 lm, R: 291 lm G: 375 lm B: 125 lm (500mA)
DELIVERED LUMEN OUTPUT	596 lm (3000K, 20°, 12W) 893 lm (3000K, 20°, 18W) RGB: 565 lm, R: 208 lm G: 268 lm B: 89 lm (500mA, 20°)
NO. AND TYPE OF LED	6, 9 power LEDs, 1/4 ANSI BIN (white LED colour) RGB: 9 power LEDs 50000h L90 B10 (Ta 25°C)
MATERIAL	body and trim in AISI 316L stainless steel screen in transparent, tempered extra-clear glass
POWER SUPPLY UNIT	not included, see p. 904 and 917
WIRING	parallel RGB: series
MOUNTING	surface mounted (ceiling, wall, ground) max depth 10 m
ACCESSORIES	see p. 759
NOTES	also suitable for use out of water version with elliptical optics available on request
PHOTOMETRIC DATA	see p. 883

< SPOT 3.0 316L
RGB, 18W

Light planning by / Garofoli
Bari Palese airport, Bari, Italy





ACCESSORIES

ACCESSORIES FOR INSTALLATION



WP0100

Spike for in-ground installation
(Spot 1.0 316L / 1.6 316L /
2.0 316L / 2.6 316L)



760

L&L Luce&Light



LINEAR PROFILES FOR UNDERWATER APPLICATIONS

POOLS AND FOUNTAINS

TREVI p. 764 **1**

RIO SUB p. 770 **2**



POOLS AND FOUNTAINS

MOUNTING

BEAM

LIGHT COLOUR

TREVI see p. 764



SURFACE MOUNTED
WITH BRACKETS

DIFFUSE VERSION
OPTICS VERSION



RIO SUB see p. 770



RECESSED

DIFFUSE VERSION





LINEAR PROFILES FOR UNDERWATER APPLICATIONS

POWER SUPPLY	PITCH	APPLIANCE CLASS
CONSTANT VOLTAGE (power supply unit not included) 24Vdc	100	◆ III
CONSTANT VOLTAGE (power supply unit not included) 24Vdc		◆ III



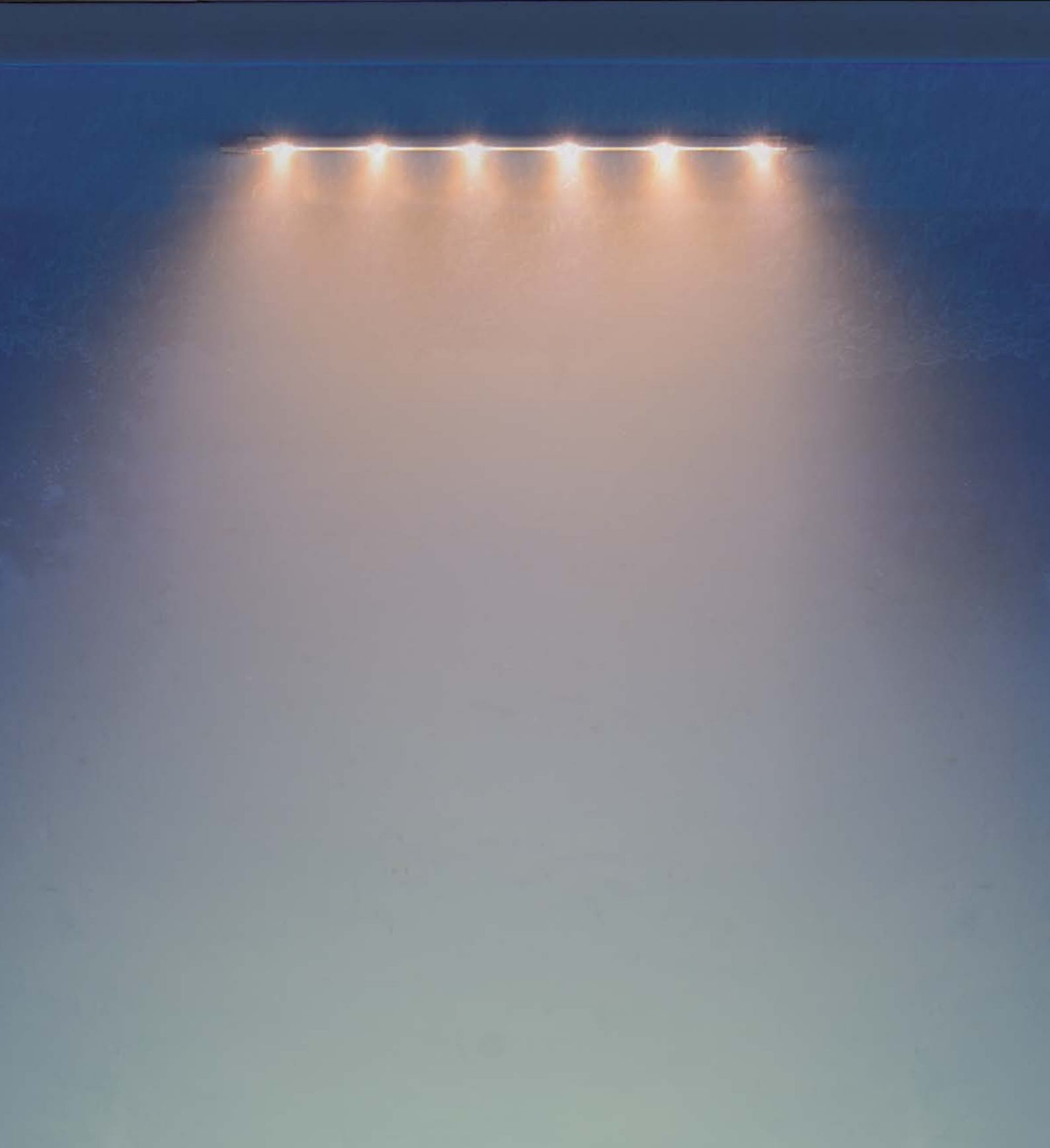



OUTDOOR AND UNDERWATER LINEAR PROFILES DIFFUSE LIGHT OR WITH OPTICS IN POOLS AND FOUNTAINS

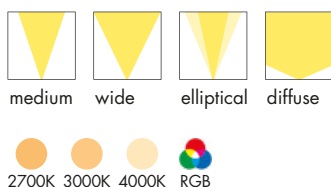

613 mm

TREVI 1.0 p. 766
white light: 7W 24Vdc (optics version)
white light: 10W 24Vdc (diffuse version)
RGB light: 11W 24Vdc (diffuse version)

1208 mm

TREVI 1.1 p. 767
white light: 14W 24Vdc (optics version)
white light: 21W 24Vdc (diffuse version)
RGB light: 24W 24Vdc (diffuse version)

1803 mm

TREVI 1.2 p. 767
white light: 21W 24Vdc (optics version)
white light: 32W 24Vdc (diffuse version)
RGB light: 37W 24Vdc (diffuse version)

✓
TREVI 1.0
 3000K, 10W, diffuse

Light planning by / City Green Light,
 ing. Patrizia Maesano
 The "Fontana del Canale"
 Campobello di Licata, Agrigento, Italy

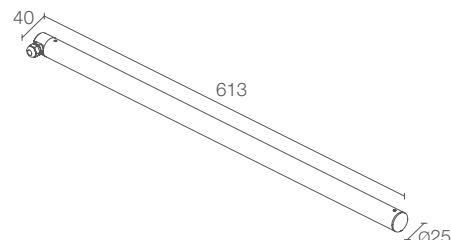

TREVI 1.0



POWER / POWER SUPPLY	7W 24Vdc white light 613 mm pitch 100 10W 24Vdc white light 613 mm diffuse
CODE	TR1000 ■ ■ A 11W 24Vdc RGB light 613 mm diffuse TR1000 6 D A
LED COLOUR	F - 2700K 5 - 3000K 9 - 4000K
OPTICS	M - 40° L - 65° W - 20°x50° D - diffuse

LUMEN OUTPUT AT SOURCE	619 lm (3000K, optics version) 1092 lm (3000K, diffuse version) RGB: 526 lm, R: 118 lm G: 336 lm B: 72 lm (diffuse version)
DELIVERED LUMEN OUTPUT	504 lm (3000K, 40°) 548 lm (3000K, diffuse optics) RGB: 376 lm, R: 84 lm G: 240 lm B: 52 lm (diffuse optics)
NO. AND TYPE OF LED	6 power LEDs, pitch 100, 1/4 ANSI BIN (optics version) 78 mid-power LEDs, 3-step MacAdam (diffuse version) RGB: 42 low-power, full-colour LEDs 50000h L90 B10 (Ta 25°C)
MATERIAL	screen in transparent polycarbonate (optics version) screen in opal polycarbonate (diffuse version) end caps in AISI 316L stainless steel
POWER SUPPLY UNIT	not included, see p. 904 and 917
POWER CABLES	includes 5 m neoprene cable H05RN-F 2x0.75 Ø6.3 mm RGB: includes 5 m FEP+PCP cable (equivalent to H05RN-F) 4x0.50/0.50 Ø6.3 mm
MOUNTING	surface mounted (ceiling, wall, ground) max depth 10 m
ACCESSORIES	see p. 769
NOTES	also suitable for use out of water available on request in the following versions: 313 mm and 4W power (optics version) 313 mm and 5W power (diffuse version) 313 mm and 5W power (RGB version)
PHOTOMETRIC DATA	see p. 895

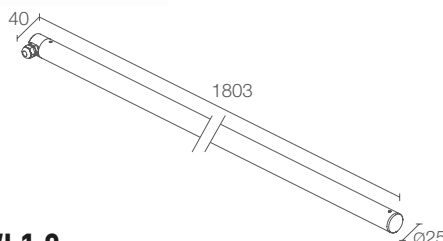
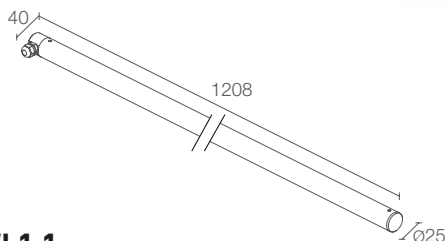

TREVI 1.1

TREVI 1.2



14W 24Vdc white light 1208 mm pitch 100
 21W 24Vdc white light 1208 mm diffuse
TR1100 ■ ■ ■ A

24W 24Vdc RGB light 1208 mm diffuse
TR1100 6 D A

21W 24Vdc white light 1803 mm pitch 100
 32W 24Vdc white light 1803 mm diffuse
TR1200 ■ ■ ■ A

37W 24Vdc RGB light 1803 mm diffuse
TR1200 6 D A

■ **F** - 2700K
 ■ **5** - 3000K
 ■ **9** - 4000K

■ **F** - 2700K
 ■ **5** - 3000K
 ■ **9** - 4000K

■ **M** - 40°
 ■ **L** - 65°
 ■ **W** - 20°x50°
 ■ **D** - diffuse

■ **M** - 40°
 ■ **L** - 65°
 ■ **W** - 20°x50°
 ■ **D** - diffuse

1237 lm (3000K, optics version)
 2268 lm (3000K, diffuse version)
 RGB: 1100 lm, R: 245 lm G: 703 lm
 B: 152 lm (diffuse version)

1856 lm (3000K, optics version)
 3444 lm (3000K, diffuse version)
 RGB: 1676 lm, R: 372 lm G: 1071 lm
 B: 233 lm (diffuse version)

1008 lm (3000K, 40°)
 1138 lm (3000K, diffuse optics)
 RGB: 786 lm, R: 175 lm G: 502 lm
 B: 109 lm (diffuse optics)

1512 lm (3000K, 40°)
 1728 lm (3000K, diffuse optics)
 RGB: 1197 lm, R: 266 lm G: 765 lm
 B: 166 lm (diffuse optics)

12 power LEDs, pitch 100, 1/4 ANSI BIN (optics version)
 162 mid-power LEDs, 3-step MacAdam (diffuse version)
 RGB: 90 low-power, full-colour LEDs
 50000h L90 B10 (Ta 25°C)

18 power LEDs, pitch 100, 1/4 ANSI BIN (optics version)
 246 mid-power LEDs, 3-step MacAdam (diffuse version)
 RGB: 138 low-power, full-colour LEDs
 50000h L90 B10 (Ta 25°C)

screen in transparent polycarbonate (optics version)
 screen in opal polycarbonate (diffuse version)
 end caps in AISI 316L stainless steel

screen in transparent polycarbonate (optics version)
 screen in opal polycarbonate (diffuse version)
 end caps in AISI 316L stainless steel

not included, see p. 904 and 917

not included, see p. 904 and 917

includes 5 m neoprene cable
 H05RN-F 2x0.75 Ø6.3 mm
 RGB: includes 5 m FEP+PCP cable (equivalent to H05RN-F) 4x0.50/0.50 Ø6.3 mm

includes 5 m neoprene cable
 H05RN-F 2x0.75 Ø6.3 mm
 RGB: includes 5 m FEP+PCP cable (equivalent to H05RN-F) 4x0.50/0.50 Ø6.3 mm

surface mounted (ceiling, wall, ground)
 max depth 10 m

surface mounted (ceiling, wall, ground)
 max depth 10 m

see p. 769

see p. 769

also suitable for use out of water available on request in the following versions:
 313 mm and 4W power (optics version)
 313 mm and 5W power (diffuse version)
 313 mm and 5W power (RGB version)

also suitable for use out of water available on request in the following versions:
 313 mm and 4W power (optics version)
 313 mm and 5W power (diffuse version)
 313 mm and 5W power (RGB version)

see p. 895

see p. 895



ACCESSORIES

ACCESSORIES FOR INSTALLATION

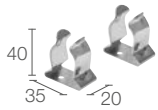

WM0501
Pair of clips

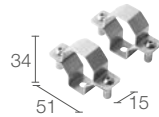

WM0502
Pair of tamper-resistant clips

∨
TREVI 1.0
with optics and clip







UNDERWATER LINEAR PROFILES FOR RECESSED LINES OF LIGHT IN POOLS AND FOUNTAINS

UNDERWATER



diffuse



510 mm



WIDTH 20 mm



RIO SUB 1.1 p. 772
white light: 6W 24Vdc
RGB light: 8.5W 24Vdc

WIDTH 37 mm



RIO SUB 2.1 p. 773
white light: 10W 24Vdc
RGB light: 8.5W 24Vdc

1010 mm

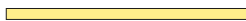

RIO SUB 1.2 p. 772
white light: 12W 24Vdc
RGB light: 17W 24Vdc



RIO SUB 2.2 p. 773
white light: 19W 24Vdc
RGB light: 17W 24Vdc

OUTDOOR

RIO p. 206



RIO SUB 1.1



IP65 IP68 IK10

A A+ A++ CASAMBI

POWER / POWER SUPPLY 6W 24Vdc white light 510 mm
8.5W 24Vdc RGB light 510 mm

CODE RS1100 ■ D B

LED COLOUR
F - 2600K
5 - 2800K
9 - 3700K
6 - RGB

OPTICS diffuse

LUMEN OUTPUT AT SOURCE 672 lm (2800K)
RGB: 140 lm, R: 30 lm G: 90 lm B: 20 lm

DELIVERED LUMEN OUTPUT 140 lm (2800K)
RGB: 100 lm, R: 22 lm G: 64 lm B: 14 lm

NO. AND TYPE OF LED 48 low-power SMD LEDs
3-step MacAdam
RGB: full-colour SDM LEDs
50000h L95 B10 (Ta 25°C)

MATERIAL body in PMMA
screen in opal PMMA
end caps in AISI 316L stainless steel

POWER SUPPLY UNIT not included, see p. 904 and 917

POWER CABLES includes 5 m neoprene cable
H05RN-F 2x1.00 Ø6.8 mm
RGB: includes 5 m FEP+PCP cable
(equivalent to H05RN-F) 4x0.50 Ø6.3 mm

MOUNTING recessed (wall, ground)
max depth 10 m

ACCESSORIES see p. 775

PHOTOMETRIC DATA see p. 871



RIO SUB 1.2



IP65 IP68 IK10

A A+ A++ CASAMBI

12W 24Vdc white light 1010 mm
17W 24Vdc RGB light 1010 mm

CODE RS1200 ■ D B

LED COLOUR
F - 2600K
5 - 2800K
9 - 3700K
6 - RGB

OPTICS diffuse

1344 lm (2800K)
RGB: 280 lm, R: 60 lm G: 180 lm B: 40 lm

280 lm (2800K)
RGB: 200 lm, R: 44 lm G: 128 lm B: 28 lm

96 low-power SMD LEDs
3-step MacAdam
RGB: full-colour SDM LEDs
50000h L95 B10 (Ta 25°C)

body in PMMA
screen in opal PMMA
end caps in AISI 316L stainless steel

not included, see p. 904 and 917

includes 5 m neoprene cable
H05RN-F 2x1.00 Ø6.8 mm
RGB: includes 5 m FEP+PCP cable
(equivalent to H05RN-F) 4x0.50 Ø6.3 mm

recessed (wall, ground)
max depth 10 m

see p. 775

see p. 871



RIO SUB 2.1



IP65 IP68 IK10

A A+ A++ CASAMBI $T_{max} 40^{\circ}C$

POWER / POWER SUPPLY 10W 24Vdc white light 510 mm
8.5W 24Vdc RGB light 510 mm

CODE RS2100 ■ D B

LED COLOUR
F - 2600K
5 - 2800K
9 - 3700K
6 - RGB

OPTICS diffuse

LUMEN OUTPUT AT SOURCE 1056 lm (2800K)
RGB: 140 lm, R: 30 lm G: 90 lm B: 20 lm

DELIVERED LUMEN OUTPUT 290 lm (2800K)
RGB: 100 lm, R: 22 lm G: 64 lm B: 14 lm

NO. AND TYPE OF LED 96 low-power SMD LEDs
3-step MacAdam
RGB: full-colour SDM LEDs
50000h L95 B10 (Ta 25°C)

MATERIAL body in PMMA
screen in opal PMMA
end caps in AISI 316L stainless steel

POWER SUPPLY UNIT not included, see p. 904 and 917

POWER CABLES includes 5 m neoprene cable
H05RN-F 2x1.00 Ø6.8 mm
RGB: includes 5 m FEP+PCP cable
(equivalent to H05RN-F) 4x0.50 Ø6.3 mm

MOUNTING recessed (wall, ground)
max depth 10 m

ACCESSORIES see p. 775

PHOTOMETRIC DATA see p. 871



RIO SUB 2.2



IP65 IP68 IK10

A A+ A++ CASAMBI $T_{max} 40^{\circ}C$

19W 24Vdc white light 1010 mm
17W 24Vdc RGB light 1010 mm

CODE RS2200 ■ D B

LED COLOUR
F - 2600K
5 - 2800K
9 - 3700K
6 - RGB

OPTICS diffuse

2112 lm (2800K)
RGB: 280 lm, R: 60 lm G: 180 lm B: 40 lm

580 lm (2800K)
RGB: 200 lm, R: 44 lm G: 128 lm B: 28 lm

192 low-power SMD LEDs
3-step MacAdam
RGB: full-colour SDM LEDs
50000h L95 B10 (Ta 25°C)

body in PMMA
screen in opal PMMA
end caps in AISI 316L stainless steel

not included, see p. 904 and 917

includes 5 m neoprene cable
H05RN-F 2x1.00 Ø6.8 mm
RGB: includes 5 m FEP+PCP cable
(equivalent to H05RN-F) 4x0.50 Ø6.3 mm

recessed (wall, ground)
max depth 10 m

see p. 775

see p. 871





ACCESSORIES

ACCESSORIES FOR INSTALLATION

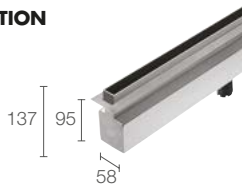

Stainless steel outer casing

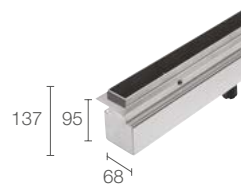

Stainless steel outer casing

RIO SUB 1.1	WC8551 - 545 mm
RIO SUB 1.2	WC8552 - 1045 mm
RIO SUB 2.1	WC8651 - 545 mm
RIO SUB 2.2	WC8652 - 1045 mm

< RIO SUB 2

3700K, 19W/m, version with customized lengths and installation

Project by / KPF, Tandem Architects
 Light planning by / Be Lit
 Rosewood Hotel, Bangkok, Thailand

√
RIO SUB 2.2
 2800K, 19W
MOBY 1.1
 RGBW, 9W, 62°





PHOTOMETRIC DATA

AKRO 1.0 1.1 1.2

R1 - 13° (13°-32°) CRI 80

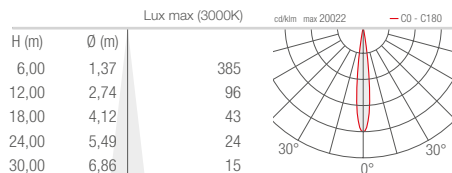

R1 - 32° (13°-32°) CRI 80

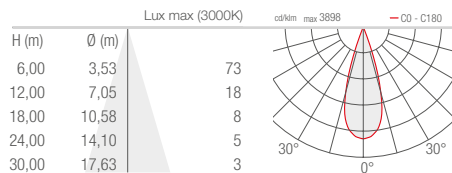

R2 - 16° (16°-42°) CRI 80

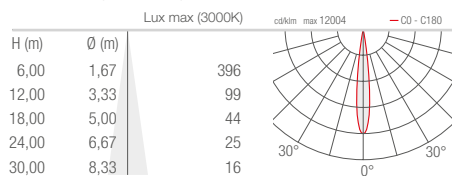

R2 - 42° (16°-42°) CRI 80

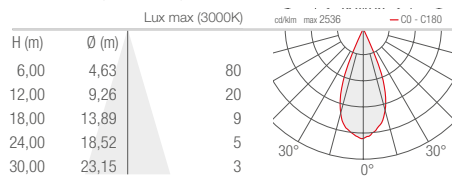



OUTDOOR RECESSED

ALTOPIANO 1

S - 19° CRI 80

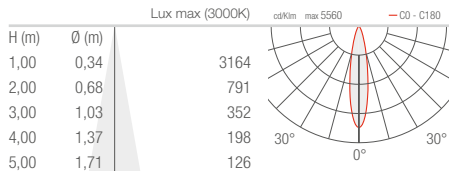

M - 25° CRI 80

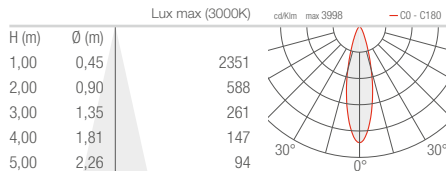

L - 37° CRI 80

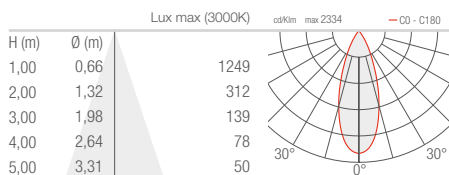

K - 50° CRI 80

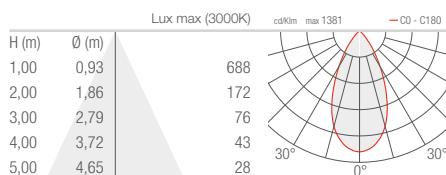

W - 23°x64° CRI 80

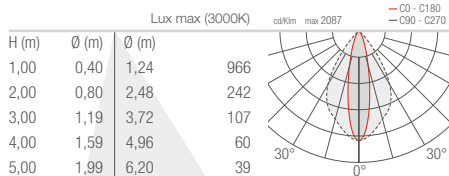

D - Diffuse CRI 80

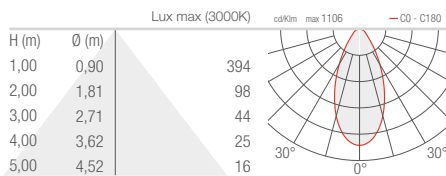

ALTOPIANO 2

S - 16° CRI 80

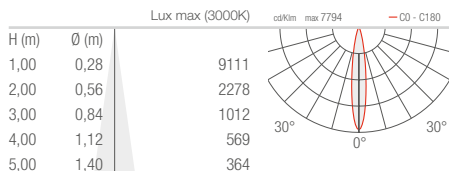

M - 26° CRI 80

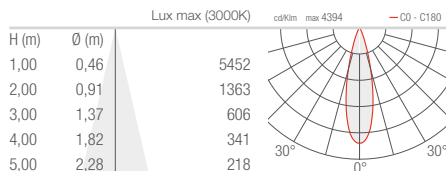

L - 38° CRI 80

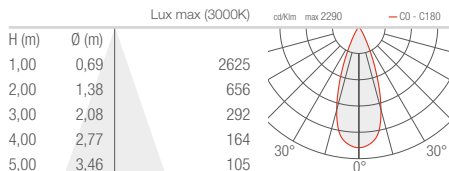

K - 57° CRI 80

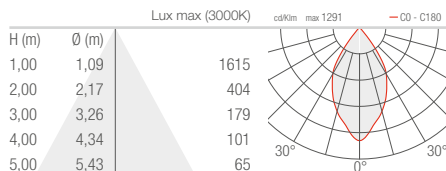

W - 16°x67° CRI 80

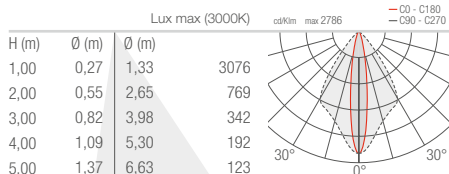

D - Diffuse CRI 80

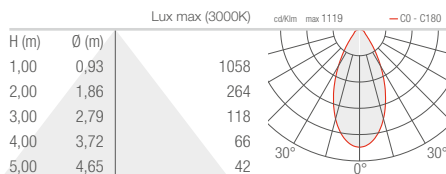

ALTOPIANO 3

S - 18° CRI 80

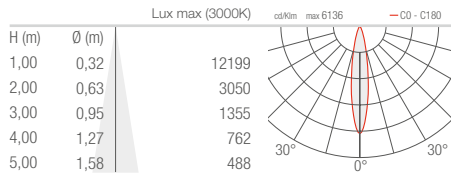

M - 24° CRI 80

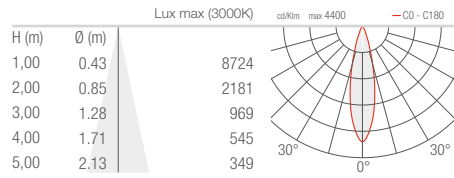

L - 37° CRI 80

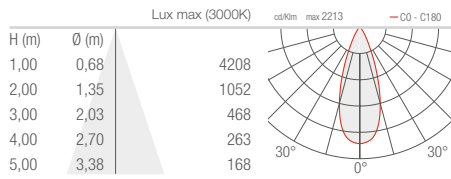

K - 61° CRI 80

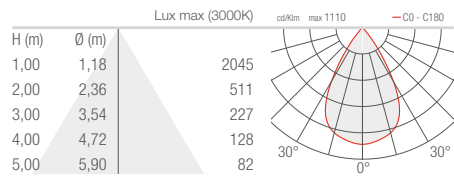

W - 20°x72° CRI 80

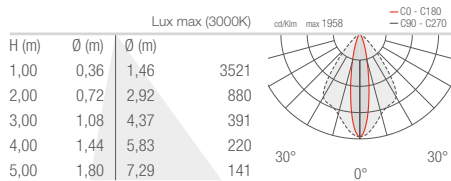

D - Diffuse CRI 80

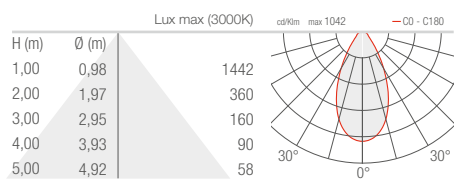

OUTDOOR RECESSED

BEAM 1.0

S - 8°

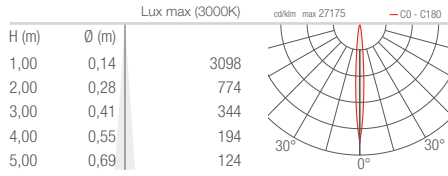

M - 26°

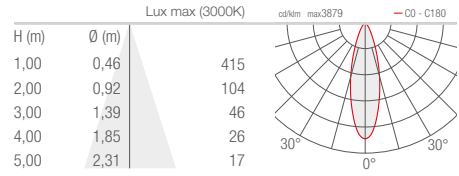

L - 44°

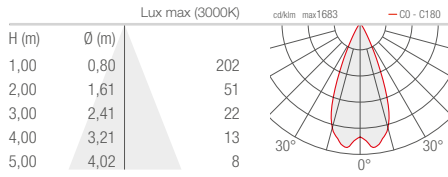

D - Diffuse

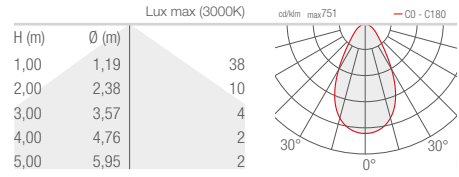

BEAM

OUTDOOR STEP LIGHTS

BEAM 2.0

- 2.1
- 2.6
- 2.7

D - Radial single beam

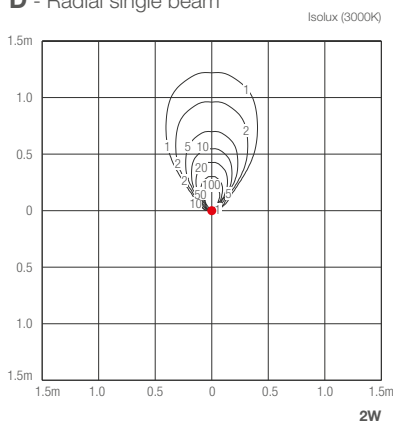

D - Radial double beam

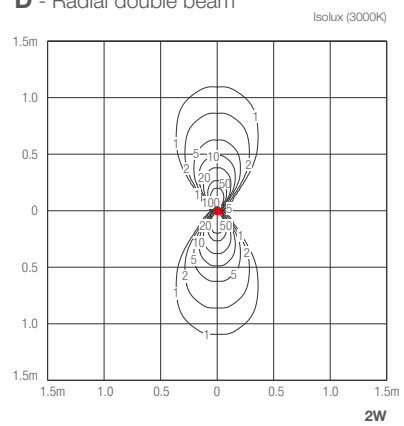

BERICA IN

INDOOR WALL MOUNTED

BERICA IN 1.0

A - Asymmetrical

Lux max (3000K)				cd/Klm max 717	— C0 - C180 — C90 - C270
H (m)	Ø (m)	Ø (m)			
0,50	0,31	0,96	796		
1,00	0,63	1,92	199		
1,50	0,94	2,88	88		
2,00	1,25	3,84	50		
2,50	1,56	4,81	32		
3,00	1,88	5,77	22		

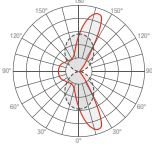

D - Diffuse

Lux max (3000K)				cd/Klm max 462	— C0 - C180 — C90 - C270
H (m)	Ø (m)	Ø (m)			
0,50	1,02	1,44	465		
1,00	2,03	2,88	116		
1,50	3,05	4,32	52		
2,00	4,06	5,75	29		
2,50	5,08	7,19	19		
3,00	6,10	8,63	13		

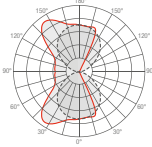

LW - 43°x96°

Lux max (3000K)				cd/Klm max 680	— C0 - C180 — C90 - C270
H (m)	Ø (m)	Ø (m)			
0,50	0,39	1,10	891		
1,00	0,78	2,20	223		
1,50	1,17	3,30	99		
2,00	1,56	4,40	56		
2,50	1,95	5,50	36		
3,00	2,34	6,60	25		

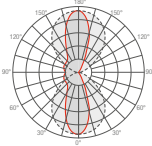

KW - 54°x90°

Lux max (3000K)				cd/Klm max 608	— C0 - C180 — C90 - C270
H (m)	Ø (m)	Ø (m)			
0,50	0,52	0,99	748		
1,00	1,03	1,98	187		
1,50	1,55	2,97	83		
2,00	2,07	3,96	47		
2,50	2,58	4,95	30		
3,00	3,10	5,95	21		

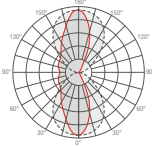

BERICA IN 1.1

A - Asymmetrical

Lux max (3000K)				cd/Klm max 717	— C0 - C180 — C90 - C270
H (m)	Ø (m)	Ø (m)			
0,50	0,31	0,96	4203		
1,00	0,63	1,92	1051		
1,50	0,94	2,88	467		
2,00	1,25	3,84	263		
2,50	1,56	4,81	168		
3,00	1,88	5,77	117		

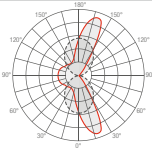

D - Diffuse

Lux max (3000K)				cd/Klm max 462	— C0 - C180 — C90 - C270
H (m)	Ø (m)	Ø (m)			
0,50	1,02	1,44	5958		
1,00	2,03	2,88	1489		
1,50	3,05	4,32	662		
2,00	4,06	5,75	372		
2,50	5,08	7,19	238		
3,00	6,10	8,63	165		

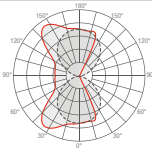

LW - 43°x96°

Lux max (3000K)				cd/Klm max 680	— C0 - C180 — C90 - C270
H (m)	Ø (m)	Ø (m)			
0,50	0,39	1,10	5666		
1,00	0,78	2,20	1416		
1,50	1,17	3,30	630		
2,00	1,56	4,40	354		
2,50	1,95	5,50	227		
3,00	2,34	6,60	157		

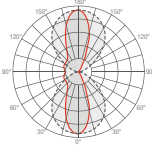

KW - 54°x90°

Lux max (3000K)				cd/Klm max 608	— C0 - C180 — C90 - C270
H (m)	Ø (m)	Ø (m)			
0,50	0,52	0,99	4150		
1,00	1,03	1,98	1038		
1,50	1,55	2,97	461		
2,00	2,07	3,96	259		
2,50	2,58	4,95	166		
3,00	3,10	5,95	115		

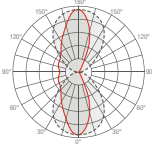

BERICA IN 1.2

A - Asymmetrical

Lux max (3000K)				cd/Klm max 717	— C0 - C180 — C90 - C270
H (m)	Ø (m)	Ø (m)			
0,50	0,31	0,96	6364		
1,00	0,63	1,92	1591		
1,50	0,94	2,88	707		
2,00	1,25	3,84	398		
2,50	1,56	4,81	255		
3,00	1,88	5,77	177		

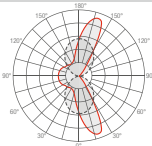

D - Diffuse

Lux max (3000K)				cd/Klm max 462	— C0 - C180 — C90 - C270
H (m)	Ø (m)	Ø (m)			
0,50	1,02	1,44	3720		
1,00	2,03	2,88	930		
1,50	3,05	4,32	413		
2,00	4,06	5,75	232		
2,50	5,08	7,19	149		
3,00	6,10	8,63	103		

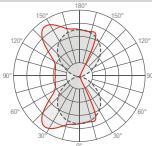

LW - 43°x96°

Lux max (3000K)				cd/Klm max 680	— C0 - C180 — C90 - C270
H (m)	Ø (m)	Ø (m)			
0,50	0,39	1,10	7127		
1,00	0,78	2,20	1782		
1,50	1,17	3,30	792		
2,00	1,56	4,40	445		
2,50	1,95	5,50	285		
3,00	2,34	6,60	198		

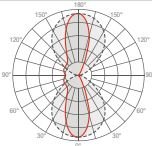

KW - 54°x90°

Lux max (3000K)				cd/Klm max 608	— C0 - C180 — C90 - C270
H (m)	Ø (m)	Ø (m)			
0,50	0,52	0,99	5986		
1,00	1,03	1,98	1496		
1,50	1,55	2,97	665		
2,00	2,07	3,96	374		
2,50	2,58	4,95	239		
3,00	3,10	5,95	166		

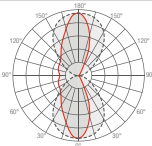

BERICA IN 2.0

A - Asymmetrical

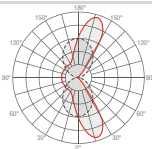
Lux max (3000K)				cd/Klm max 706	
H (m)	Ø (m)	Ø (m)			
0,50	0,37	0,97	796		
1,00	0,73	1,95	199		
1,50	1,10	2,92	88		
2,00	1,46	3,90	50		
2,50	1,83	4,87	32		
3,00	2,19	5,84	22		

D - Diffuse

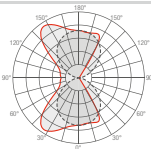
Lux max (3000K)				cd/Klm max 466	
H (m)	Ø (m)	Ø (m)			
0,50	1,02	1,48	467		
1,00	2,03	2,96	117		
1,50	3,05	4,44	52		
2,00	4,06	5,92	29		
2,50	5,08	7,40	19		
3,00	6,10	8,88	13		

LW - 45°x96°

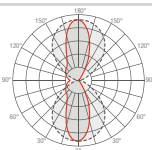
Lux max (3000K)				cd/Klm max 672	
H (m)	Ø (m)	Ø (m)			
0,50	0,41	1,11	898		
1,00	0,82	2,22	225		
1,50	1,22	3,34	100		
2,00	1,63	4,45	56		
2,50	2,04	5,56	36		
3,00	2,45	6,67	25		

KW - 57°x90°

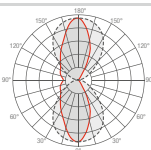
Lux max (3000K)				cd/Klm max 604	
H (m)	Ø (m)	Ø (m)			
0,50	0,56	0,99	762		
1,00	1,11	1,98	191		
1,50	1,67	2,97	85		
2,00	2,22	3,96	48		
2,50	2,78	4,95	30		
3,00	3,33	5,94	21		

BERICA IN 2.1

A - Asymmetrical

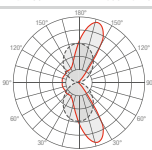
Lux max (3000K)				cd/Klm max 706	
H (m)	Ø (m)	Ø (m)			
0,50	0,37	0,97	4242		
1,00	0,73	1,95	1061		
1,50	1,10	2,92	471		
2,00	1,46	3,90	265		
2,50	1,83	4,87	170		
3,00	2,19	5,84	118		

D - Diffuse

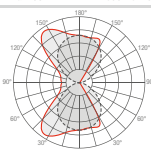
Lux max (3000K)				cd/Klm max 466	
H (m)	Ø (m)	Ø (m)			
0,50	1,02	1,48	5300		
1,00	2,03	2,96	1325		
1,50	3,05	4,44	589		
2,00	4,06	5,92	331		
2,50	5,08	7,40	212		
3,00	6,10	8,88	147		

LW - 45°x96°

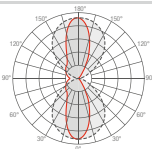
Lux max (3000K)				cd/Klm max 672	
H (m)	Ø (m)	Ø (m)			
0,50	0,41	1,11	4277		
1,00	0,82	2,22	1069		
1,50	1,22	3,34	475		
2,00	1,63	4,45	267		
2,50	2,04	5,56	171		
3,00	2,45	6,67	119		

KW - 57°x90°

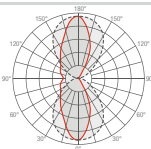
Lux max (3000K)				cd/Klm max 604	
H (m)	Ø (m)	Ø (m)			
0,50	0,56	0,99	4628		
1,00	1,11	1,98	1157		
1,50	1,67	2,97	514		
2,00	2,22	3,96	289		
2,50	2,78	4,95	185		
3,00	3,33	5,94	129		

BERICA IN 2.2

A - Asymmetrical

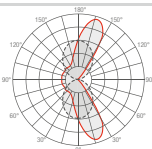
Lux max (3000K)				cd/Klm max 706	
H (m)	Ø (m)	Ø (m)			
0,50	0,37	0,97	6366		
1,00	0,73	1,95	1592		
1,50	1,10	2,92	707		
2,00	1,46	3,90	398		
2,50	1,83	4,87	255		
3,00	2,19	5,84	177		

D - Diffuse

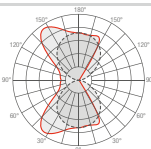
Lux max (3000K)				cd/Klm max 466	
H (m)	Ø (m)	Ø (m)			
0,50	1,02	1,48	3736		
1,00	2,03	2,96	934		
1,50	3,05	4,44	415		
2,00	4,06	5,92	233		
2,50	5,08	7,40	149		
3,00	6,10	8,88	104		

LW - 45°x96°

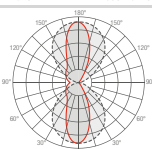
Lux max (3000K)				cd/Klm max 672	
H (m)	Ø (m)	Ø (m)			
0,50	0,41	1,11	7186		
1,00	0,82	2,22	1796		
1,50	1,22	3,34	798		
2,00	1,63	4,45	449		
2,50	2,04	5,56	287		
3,00	2,45	6,67	200		

KW - 57°x90°

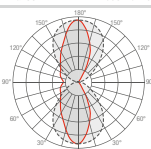
Lux max (3000K)				cd/Klm max 604	
H (m)	Ø (m)	Ø (m)			
0,50	0,56	0,99	6099		
1,00	1,11	1,98	1525		
1,50	1,67	2,97	678		
2,00	2,22	3,96	381		
2,50	2,78	4,95	244		
3,00	3,33	5,94	169		

BERICA IN 3.0

A - Asymmetrical

Lux max (3000K)				cd/Klm max 706	— C0 - C180 — C90 - C270
H (m)	Ø (m)	Ø (m)			
0,50	0,46	1,02	818		
1,00	0,91	2,05	204		
1,50	1,37	3,07	91		
2,00	1,82	4,10	51		
2,50	2,28	5,12	33		
3,00	2,73	6,14	23		

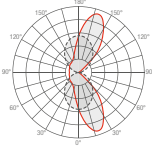

D - Diffuse

Lux max (3000K)				cd/Klm max 414	— C0 - C180 — C90 - C270
H (m)	Ø (m)	Ø (m)			
0,50	1,12	1,43	467		
1,00	2,23	2,87	117		
1,50	3,35	4,30	52		
2,00	4,46	5,73	29		
2,50	5,58	7,17	19		
3,00	6,69	8,60	13		

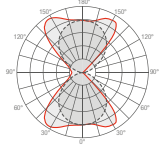

LW - 45°x96°

Lux max (3000K)				cd/Klm max 670	— C0 - C180 — C90 - C270
H (m)	Ø (m)	Ø (m)			
0,50	0,41	1,10	895		
1,00	0,83	2,21	224		
1,50	1,24	3,31	99		
2,00	1,65	4,42	56		
2,50	2,07	5,52	36		
3,00	2,48	6,63	25		

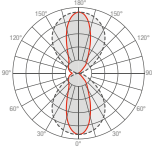

KW - 59°x90°

Lux max (3000K)				cd/Klm max 592	— C0 - C180 — C90 - C270
H (m)	Ø (m)	Ø (m)			
0,50	0,57	0,98	753		
1,00	1,14	1,97	188		
1,50	1,71	2,95	84		
2,00	2,28	3,93	47		
2,50	2,85	4,92	30		
3,00	3,42	5,90	21		

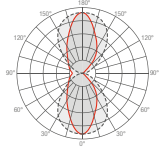

BERICA IN 3.1

A - Asymmetrical

Lux max (3000K)				cd/Klm max 706	— C0 - C180 — C90 - C270
H (m)	Ø (m)	Ø (m)			
0,50	0,46	1,02	2929		
1,00	0,91	2,05	732		
1,50	1,37	3,07	325		
2,00	1,82	4,10	183		
2,50	2,28	5,12	117		
3,00	2,73	6,14	81		

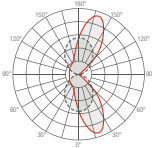

D - Diffuse

Lux max (3000K)				cd/Klm max 414	— C0 - C180 — C90 - C270
H (m)	Ø (m)	Ø (m)			
0,50	1,12	1,43	6928		
1,00	2,23	2,87	1732		
1,50	3,35	4,30	770		
2,00	4,46	5,73	433		
2,50	5,58	7,17	277		
3,00	6,69	8,60	192		

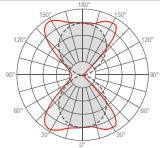

LW - 45°x96°

Lux max (3000K)				cd/Klm max 670	— C0 - C180 — C90 - C270
H (m)	Ø (m)	Ø (m)			
0,50	0,41	1,10	4366		
1,00	0,83	2,21	1092		
1,50	1,24	3,31	485		
2,00	1,65	4,42	273		
2,50	2,07	5,52	175		
3,00	2,48	6,63	121		

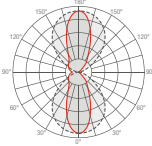

KW - 59°x90°

Lux max (3000K)				cd/Klm max 592	— C0 - C180 — C90 - C270
H (m)	Ø (m)	Ø (m)			
0,50	0,57	0,98	5005		
1,00	1,14	1,97	1251		
1,50	1,71	2,95	556		
2,00	2,28	3,93	313		
2,50	2,85	4,92	200		
3,00	3,42	5,90	139		

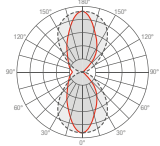

BERICA IN 3.2

A - Asymmetrical

Lux max (3000K)				cd/Klm max 706	— C0 - C180 — C90 - C270
H (m)	Ø (m)	Ø (m)			
0,50	0,46	1,02	6542		
1,00	0,91	2,05	1636		
1,50	1,37	3,07	727		
2,00	1,82	4,10	409		
2,50	2,28	5,12	262		
3,00	2,73	6,14	182		

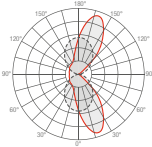

D - Diffuse

Lux max (3000K)				cd/Klm max 207	— C0 - C180 — C90 - C270
H (m)	Ø (m)	Ø (m)			
0,50	1,12	1,43	3738		
1,00	2,23	2,87	934		
1,50	3,35	4,30	415		
2,00	4,46	5,73	234		
2,50	5,58	7,17	150		
3,00	6,69	8,60	104		

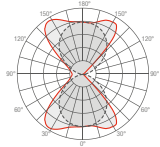

LW - 45°x96°

Lux max (3000K)				cd/Klm max 670	— C0 - C180 — C90 - C270
H (m)	Ø (m)	Ø (m)			
0,50	0,41	1,10	7159		
1,00	0,83	2,21	1790		
1,50	1,24	3,31	795		
2,00	1,65	4,42	447		
2,50	2,07	5,52	286		
3,00	2,48	6,63	199		

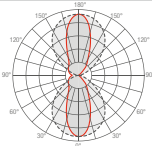

KW - 59°x90°

Lux max (3000K)				cd/Klm max 592	— C0 - C180 — C90 - C270
H (m)	Ø (m)	Ø (m)			
0,50	0,57	0,98	6021		
1,00	1,14	1,97	1505		
1,50	1,71	2,95	669		
2,00	2,28	3,93	376		
2,50	2,85	4,92	241		
3,00	3,42	5,90	167		

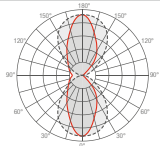



OUTDOOR WALL MOUNTED

BERICA OUT 1.0

OA - Asymmetrical CRI 80

Lux max (3000K)		cd/klm max 329	
H (m)	Ø (m)	Ø (m)	
1,00	0,29	2,11	391
2,00	0,59	4,22	98
3,00	0,88	6,33	43
4,00	1,17	8,44	24
5,00	1,46	10,55	16

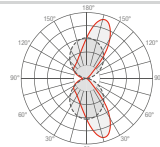

OD - Diffuse CRI 80

Lux max (3000K)		cd/klm max 205	
H (m)	Ø (m)	Ø (m)	
1,00	2,95	2,56	266
2,00	5,90	5,11	66
3,00	8,85	7,67	30
4,00	11,79	10,22	17
5,00	14,74	12,78	11

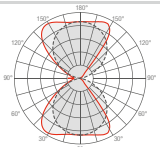

LW - 42°x102° CRI 80

Lux max (3000K)		cd/klm max 299	
H (m)	Ø (m)	Ø (m)	
1,00	1,35	2,37	416
2,00	2,70	4,74	104
3,00	4,06	7,11	46
4,00	5,41	9,48	26
5,00	6,76	11,85	17

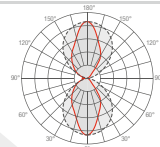

KW - 62°x100° CRI 80

Lux max (3000K)		cd/klm max 325	
H (m)	Ø (m)	Ø (m)	
1,00	0,75	2,44	429
2,00	1,51	4,89	107
3,00	2,26	7,33	48
4,00	3,02	9,77	27
5,00	3,77	12,22	17

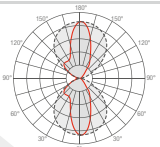

BERICA OUT 1.1

OA - Asymmetrical CRI 80

Lux max (3000K)		cd/klm max 329	
H (m)	Ø (m)	Ø (m)	
1,00	0,29	2,11	783
2,00	0,59	4,22	196
3,00	0,88	6,33	87
4,00	1,17	8,44	49
5,00	1,46	10,55	31

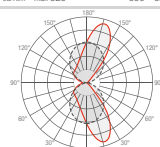

OD - Diffuse CRI 80

Lux max (3000K)		cd/klm max 205	
H (m)	Ø (m)	Ø (m)	
1,00	2,95	2,56	531
2,00	5,90	5,11	133
3,00	8,85	7,67	59
4,00	11,79	10,22	33
5,00	14,74	12,78	21

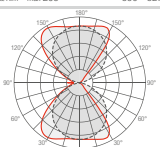

LW - 42°x102° CRI 80

Lux max (3000K)		cd/klm max 325	
H (m)	Ø (m)	Ø (m)	
1,00	0,75	2,44	859
2,00	1,51	4,89	215
3,00	2,26	7,33	95
4,00	3,02	9,77	54
5,00	3,77	12,22	34

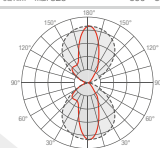

KW - 62°x100° CRI 80

Lux max (3000K)		cd/klm max 299	
H (m)	Ø (m)	Ø (m)	
1,00	1,35	2,37	831
2,00	2,70	4,74	208
3,00	4,06	7,11	92
4,00	5,41	9,48	52
5,00	6,76	11,85	33

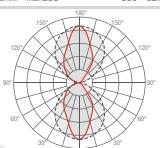

BERICA OUT 1.2

OA - Asymmetrical CRI 80

Lux max (3000K)		cd/klm max 329	
H (m)	Ø (m)	Ø (m)	
1,00	0,29	2,11	1566
2,00	0,59	4,22	391
3,00	0,88	6,33	174
4,00	1,17	8,44	98
5,00	1,46	10,55	63

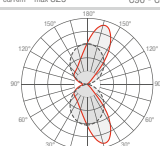

OD - Diffuse CRI 80

Lux max (3000K)		cd/klm max 205	
H (m)	Ø (m)	Ø (m)	
1,00	2,95	2,56	1063
2,00	5,90	5,11	266
3,00	8,85	7,67	118
4,00	11,79	10,22	66
5,00	14,74	12,78	43

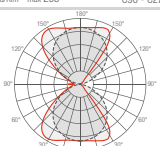

LW - 42°x102° CRI 80

Lux max (3000K)		cd/klm max 325	
H (m)	Ø (m)	Ø (m)	
1,00	0,75	2,44	1718
2,00	1,51	4,89	429
3,00	2,26	7,33	191
4,00	3,02	9,77	107
5,00	3,77	12,22	69

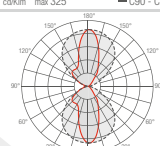

KW - 62°x100° CRI 80

Lux max (3000K)		cd/klm max 299	
H (m)	Ø (m)	Ø (m)	
1,00	1,35	2,37	1662
2,00	2,70	4,74	416
3,00	4,06	7,11	185
4,00	5,41	9,48	104
5,00	6,76	11,85	66

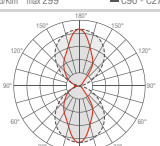

BERICA OUT 2.0

OA - Asymmetrical CRI 80

Lux max (3000K)		cd/Klm max 318	
H (m)	Ø (m)	Ø (m)	
1,00	0,27	2,08	391
2,00	0,55	4,16	98
3,00	0,82	6,24	43
4,00	1,09	8,32	24
5,00	1,37	10,40	16

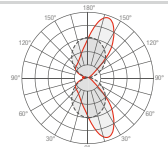

OD - Diffuse CRI 80

Lux max (3000K)		cd/Klm max 201	
H (m)	Ø (m)	Ø (m)	
1,00	2,95	2,66	266
2,00	5,89	5,33	67
3,00	8,84	7,99	30
4,00	11,78	10,66	17
5,00	14,73	13,32	11

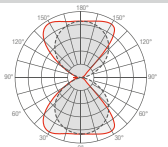

LW - 42°x102° CRI 80

Lux max (3000K)		cd/Klm max 320	
H (m)	Ø (m)	Ø (m)	
1,00	0,78	2,46	432
2,00	1,57	4,92	108
3,00	2,35	7,38	48
4,00	3,13	9,84	27
5,00	3,92	12,31	17

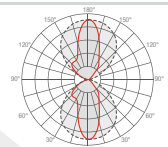

KW - 62°x100° CRI 80

Lux max (3000K)		cd/Klm max 292	
H (m)	Ø (m)	Ø (m)	
1,00	1,38	2,38	414
2,00	2,75	4,76	103
3,00	4,13	7,14	46
4,00	5,50	9,51	26
5,00	6,88	11,89	17

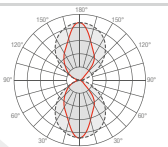

BERICA OUT 2.1

OA - Asymmetrical CRI 80

Lux max (3000K)		cd/Klm max 318	
H (m)	Ø (m)	Ø (m)	
1,00	0,27	2,08	781
2,00	0,55	4,16	195
3,00	0,82	6,24	87
4,00	1,09	8,32	49
5,00	1,37	10,40	31

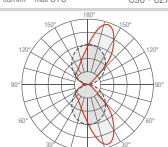

OD - Diffuse CRI 80

Lux max (3000K)		cd/Klm max 201	
H (m)	Ø (m)	Ø (m)	
1,00	2,95	2,66	533
2,00	5,89	5,33	133
3,00	8,84	7,99	59
4,00	11,78	10,66	33
5,00	14,73	13,32	21

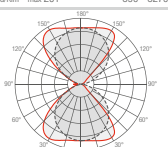

LW - 42°x102° CRI 80

Lux max (3000K)		cd/Klm max 320	
H (m)	Ø (m)	Ø (m)	
1,00	0,78	2,46	864
2,00	1,57	4,92	216
3,00	2,35	7,38	96
4,00	3,13	9,84	54
5,00	3,92	12,31	35

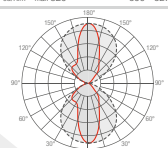

KW - 62°x100° CRI 80

Lux max (3000K)		cd/Klm max 292	
H (m)	Ø (m)	Ø (m)	
1,00	1,38	2,38	827
2,00	2,75	4,76	207
3,00	4,13	7,14	92
4,00	5,50	9,51	52
5,00	6,88	11,89	33

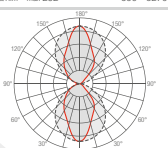

BERICA OUT 2.2

OA - Asymmetrical CRI 80

Lux max (3000K)		cd/Klm max 318	
H (m)	Ø (m)	Ø (m)	
1,00	0,27	2,08	1562
2,00	0,55	4,16	391
3,00	0,82	6,24	174
4,00	1,09	8,32	98
5,00	1,37	10,40	62

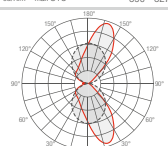

OD - Diffuse CRI 80

Lux max (3000K)		cd/Klm max 201	
H (m)	Ø (m)	Ø (m)	
1,00	2,95	2,66	1066
2,00	5,89	5,33	266
3,00	8,84	7,99	118
4,00	11,78	10,66	67
5,00	14,73	13,32	43

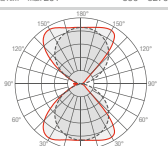

LW - 42°x102° CRI 80

Lux max (3000K)		cd/Klm max 320	
H (m)	Ø (m)	Ø (m)	
1,00	0,78	2,46	1727
2,00	1,57	4,92	432
3,00	2,35	7,38	192
4,00	3,13	9,84	108
5,00	3,92	12,31	69

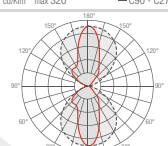

KW - 62°x100° CRI 80

Lux max (3000K)		cd/Klm max 292	
H (m)	Ø (m)	Ø (m)	
1,00	1,38	2,38	1655
2,00	2,75	4,76	414
3,00	4,13	7,14	184
4,00	5,50	9,51	103
5,00	6,88	11,89	66

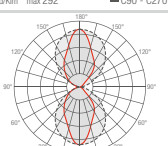

BERICA OUT 3.0

OA - Asymmetrical CRI 80

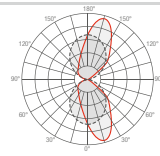
		Lux max (3000K)		cd/Klm max 315	
H (m)	Ø (m)	Ø (m)			
1,00	0,34	2,11	428		
2,00	0,68	4,22	107		
3,00	1,03	6,33	48		
4,00	1,37	8,44	27		
5,00	1,71	10,55	17		

OD - Diffuse CRI 80

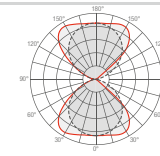
		Lux max (3000K)		cd/Klm max 190	
H (m)	Ø (m)	Ø (m)			
1,00	2,91	2,63	267		
2,00	5,82	5,25	67		
3,00	8,73	7,88	30		
4,00	11,64	10,50	17		
5,00	14,55	13,13	11		

LW - 42°x102° CRI 80

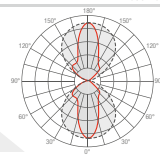
		Lux max (3000K)		cd/Klm max 313	
H (m)	Ø (m)	Ø (m)			
1,00	0,80	2,47	435		
2,00	1,61	4,93	109		
3,00	2,41	7,40	48		
4,00	3,21	9,86	27		
5,00	4,02	12,33	17		

KW - 62°x100° CRI 80

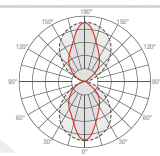
		Lux max (3000K)		cd/Klm max 290	
H (m)	Ø (m)	Ø (m)			
1,00	1,34	2,38	401		
2,00	2,68	4,76	100		
3,00	4,02	7,14	45		
4,00	5,36	9,52	25		
5,00	6,70	11,89	16		

BERICA OUT 3.1

OA - Asymmetrical CRI 80

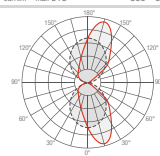
		Lux max (3000K)		cd/Klm max 315	
H (m)	Ø (m)	Ø (m)			
1,00	0,34	2,11	855		
2,00	0,68	4,22	214		
3,00	1,03	6,33	95		
4,00	1,37	8,44	53		
5,00	1,71	10,55	34		

OD - Diffuse CRI 80

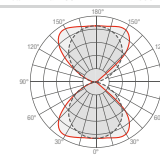
		Lux max (3000K)		cd/Klm max 190	
H (m)	Ø (m)	Ø (m)			
1,00	2,91	2,63	534		
2,00	5,82	5,25	134		
3,00	8,73	7,88	59		
4,00	11,64	10,50	33		
5,00	14,55	13,13	21		

LW - 42°x102° CRI 80

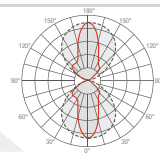
		Lux max (3000K)		cd/Klm max 313	
H (m)	Ø (m)	Ø (m)			
1,00	0,80	2,47	870		
2,00	1,61	4,93	218		
3,00	2,41	7,40	97		
4,00	3,21	9,86	54		
5,00	4,02	12,33	35		

KW - 62°x100° CRI 80

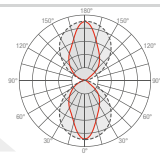
		Lux max (3000K)		cd/Klm max 290	
H (m)	Ø (m)	Ø (m)			
1,00	1,34	2,38	803		
2,00	2,68	4,76	201		
3,00	4,02	7,14	89		
4,00	5,36	9,52	50		
5,00	6,70	11,89	32		

BERICA OUT 3.2

OA - Asymmetrical CRI 80

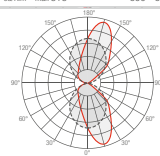
		Lux max (3000K)		cd/Klm max 315	
H (m)	Ø (m)	Ø (m)			
1,00	0,34	2,11	1710		
2,00	0,68	4,22	428		
3,00	1,03	6,33	190		
4,00	1,37	8,44	107		
5,00	1,71	10,55	68		

OD - Diffuse CRI 80

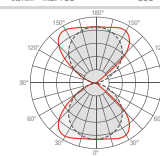
		Lux max (3000K)		cd/Klm max 190	
H (m)	Ø (m)	Ø (m)			
1,00	2,91	2,63	1069		
2,00	5,82	5,25	267		
3,00	8,73	7,88	119		
4,00	11,64	10,50	67		
5,00	14,55	13,13	43		

LW - 42°x102° CRI 80

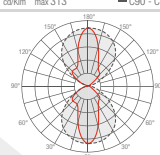
		Lux max (3000K)		cd/Klm max 313	
H (m)	Ø (m)	Ø (m)			
1,00	0,80	2,47	1740		
2,00	1,61	4,93	435		
3,00	2,41	7,40	193		
4,00	3,21	9,86	109		
5,00	4,02	12,33	70		

KW - 62°x100° CRI 80

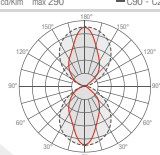
		Lux max (3000K)		cd/Klm max 290	
H (m)	Ø (m)	Ø (m)			
1,00	1,34	2,38	1605		
2,00	2,68	4,76	401		
3,00	4,02	7,14	178		
4,00	5,36	9,52	100		
5,00	6,70	11,89	64		

BERICA S

SUSPENDED FOR INDOOR APPLICATIONS

BERICA S 1.0

L - 44°x90°

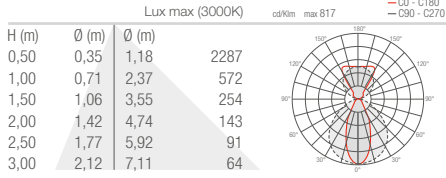

K - 58°x99°

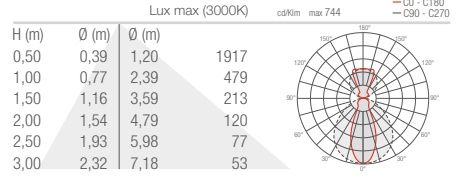

D - Diffuse

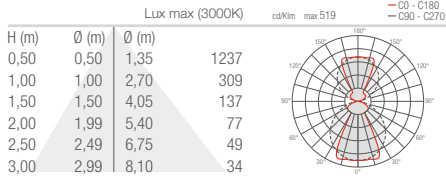

BERICA S 1.1

L - 44°x90°

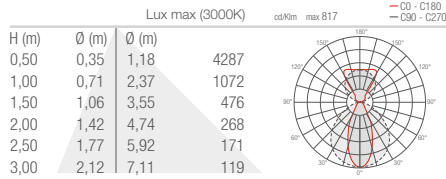

K - 58°x99°

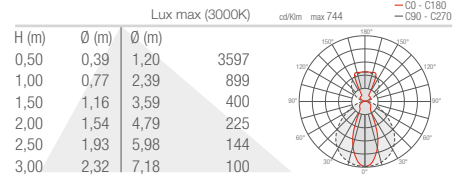

D - Diffuse

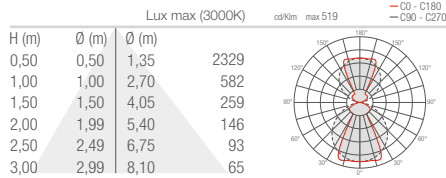

BERICA S 1.2

L - 44°x90°

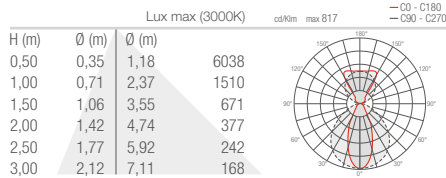

K - 58°x99°

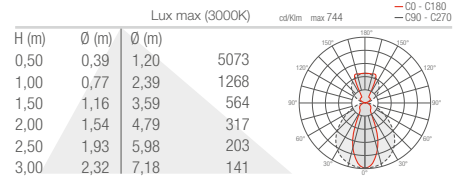

D - Diffuse

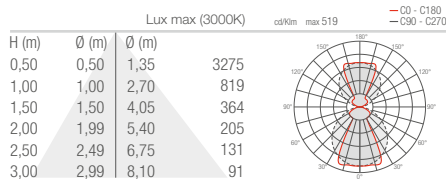

BERICA S 2.0

L - 44°x90°

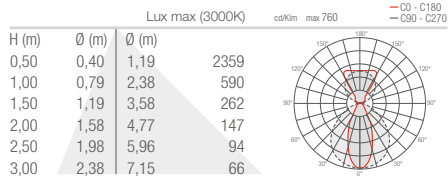

K - 58°x99°

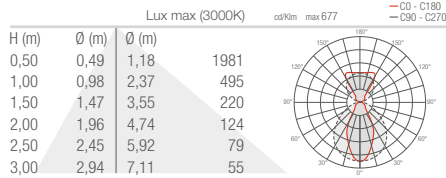

D - Diffuse

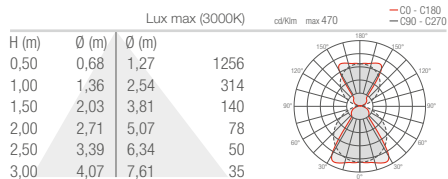

BERICA S 2.1

L - 44°x90°

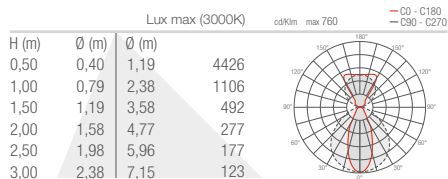

K - 58°x99°

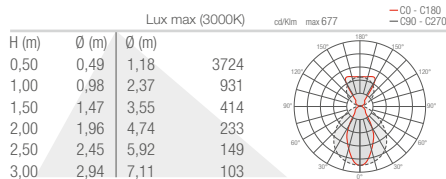

D - Diffuse

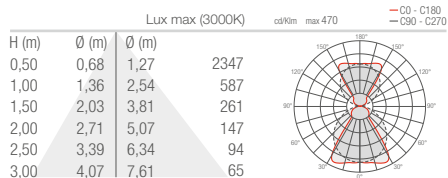

BERICA S 2.2

L - 44°x90°

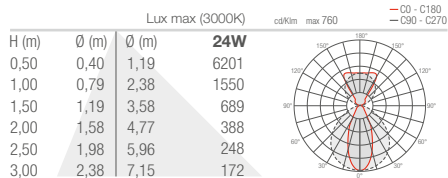

K - 58°x99°

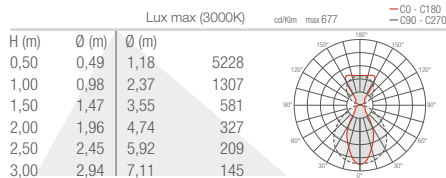

D - Diffuse

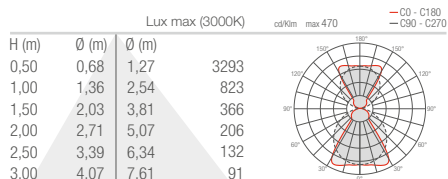

BERICA S 3.0

L - 44°x90°

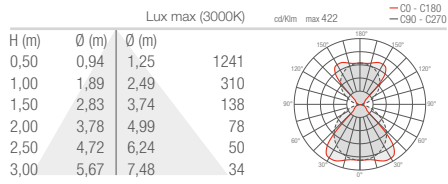
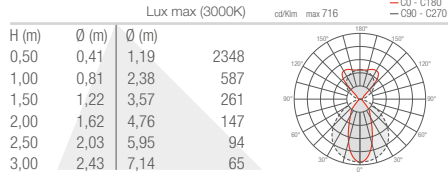

K - 58°x99°

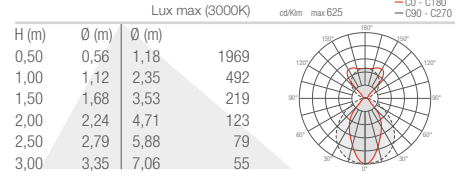

BERICA S 3.1

L - 44°x90°

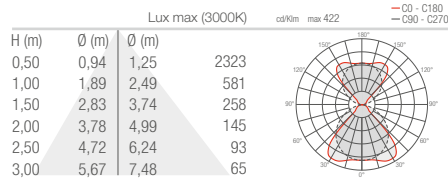
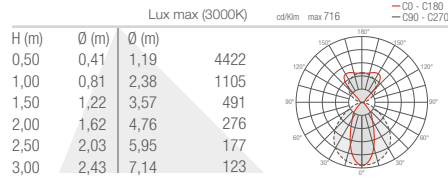

K - 58°x99°

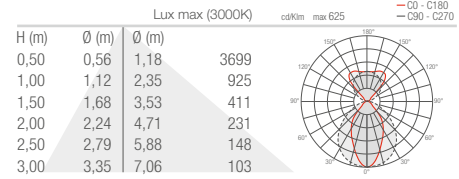

BERICA S 3.2

L - 44°x90°

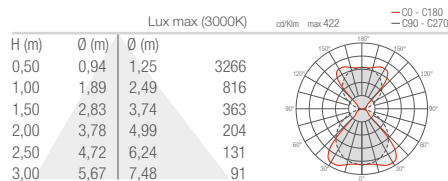
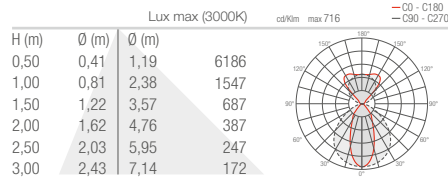

K - 58°x99°

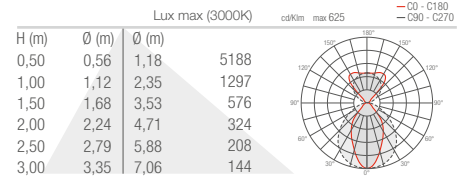



INDOOR RECESSED

BITPOP 1.0

S - 17°

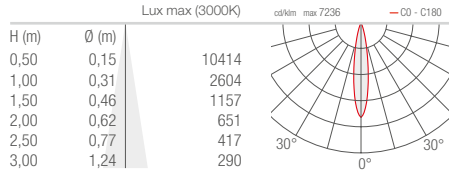

F - 30°

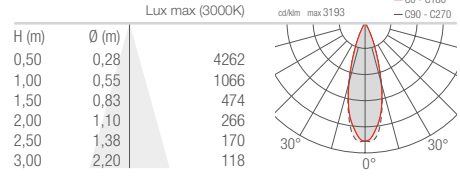

L - 42°

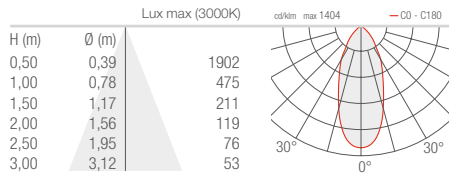

W - 17°x45°

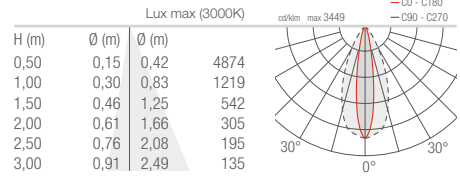

BITPOP 2.1

S - 17°

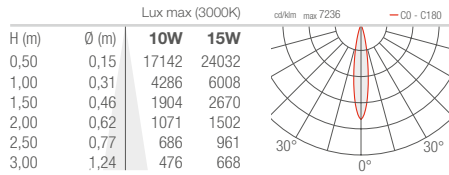

F - 30°

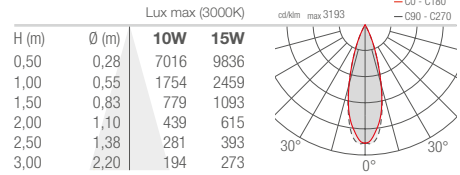

L - 42°

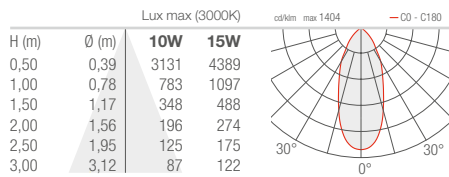

W - 17°x45°

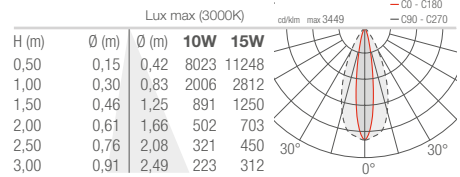

BITPOP 2.2 4.1

S - 17°

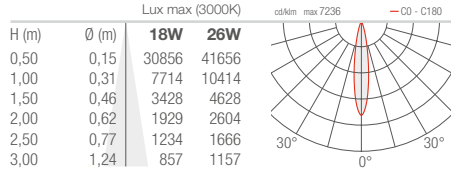

F - 30°

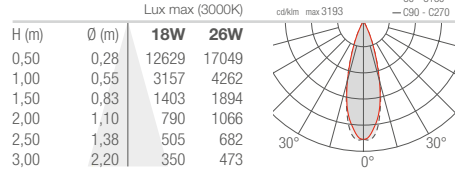

L - 42°

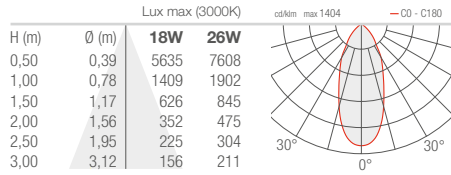

W - 17°x45°

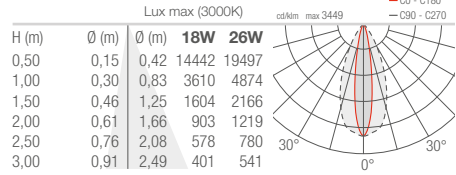

BITPOP 8.1

S - 17°

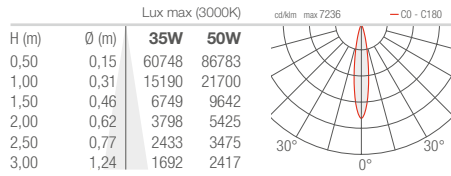

F - 30°

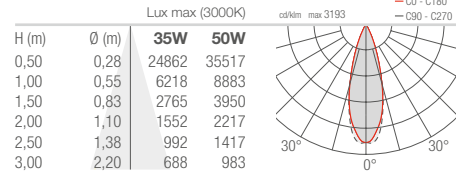

L - 42°

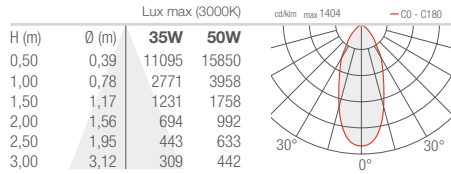

W - 17°x45°

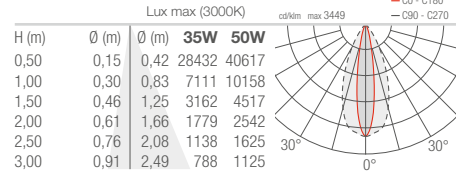



INDOOR CEILING MOUNTED

BITPOP C 1.0

S - 17°

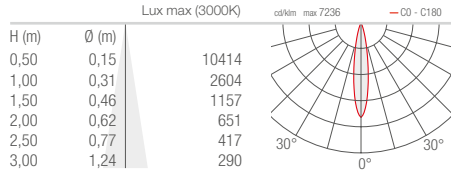

F - 30°

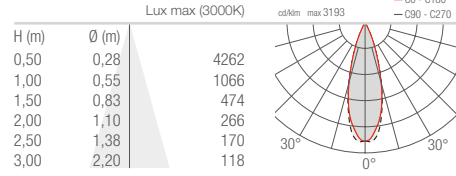

L - 42°

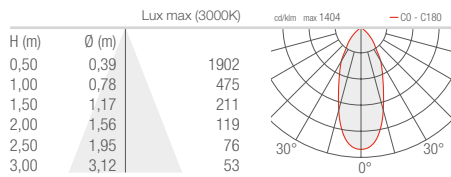

W - 17°x45°

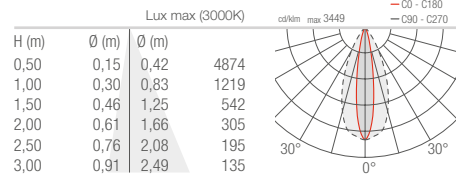

BITPOP C 2.2 4.1

S - 17°

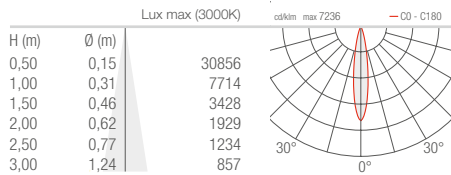

F - 30°

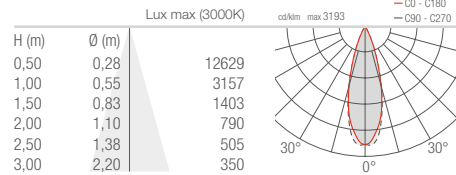

L - 42°

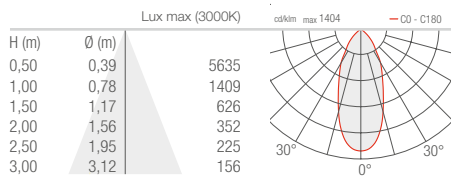

W - 17°x45°

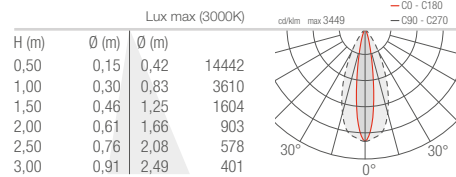

BITTA 1.0

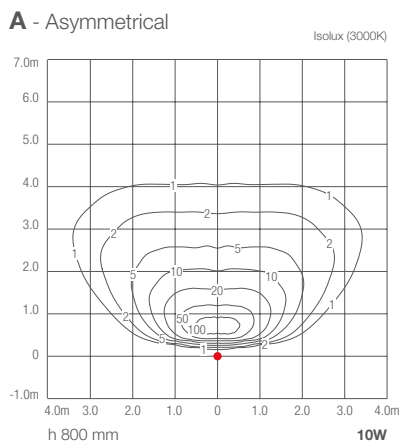
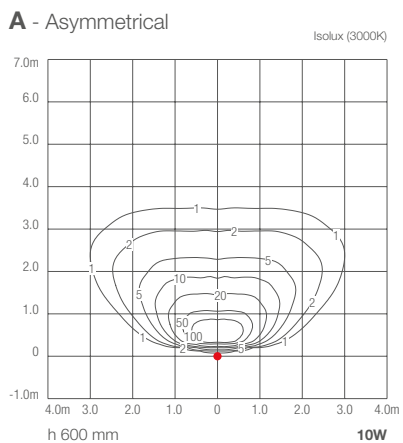



INDOOR LINEAR PROFILES

BRENTA 1

Diffuse flush installation - 562 mm

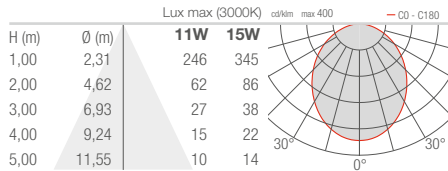

Microprismatic flush installation - 562 mm

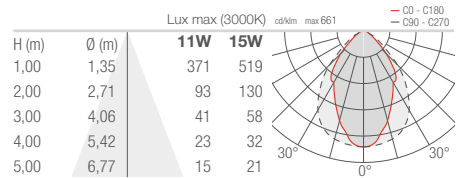

Diffuse deep-set installation - 562 mm

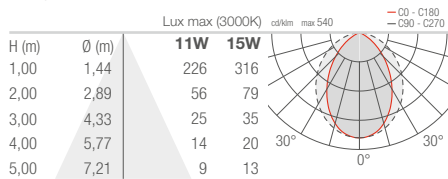

Microprismatic deep-set installation - 562 mm

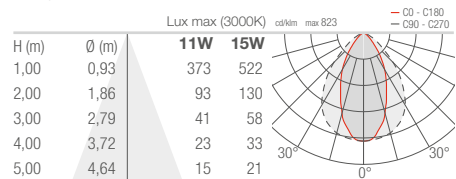

BRENTA 2

Diffuse flush installation - 562 mm

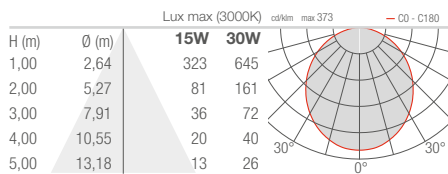

Microprismatic flush installation - 562 mm

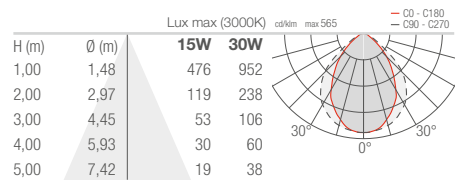

Diffuse deep-set installation - 562 mm

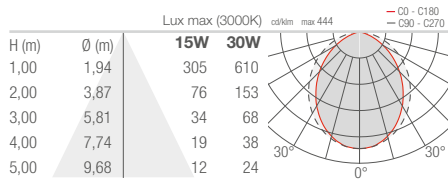

Microprismatic deep-set installation - 562 mm

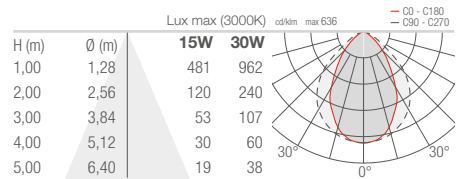

BRIGHT

OUTDOOR RECESSED

BRIGHT MINI 1.0 1.1

D - Diffuse

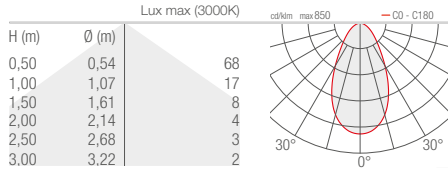

BRIGHT 1.0 1.1 1.2 1.6 1.7

S - 10°

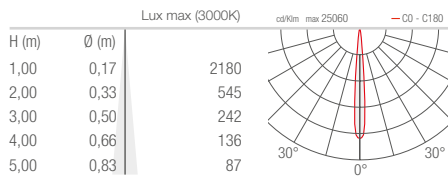

V - 21° sharp (Bright 1.0 / 1.6)

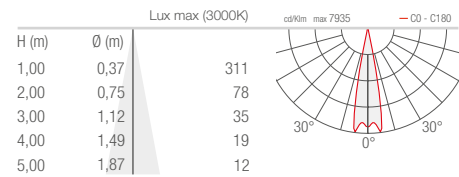

M - 21°

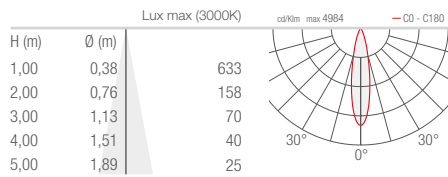

L - 43°

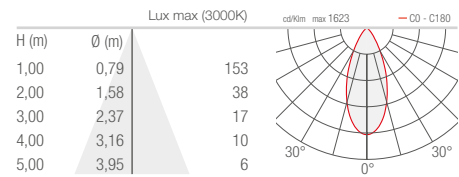

T - 54° sharp (Bright 1.0 / 1.6)

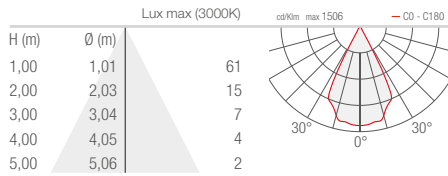

W - 15°x38° sharp (Bright 1.0 / 1.2 / 1.6)

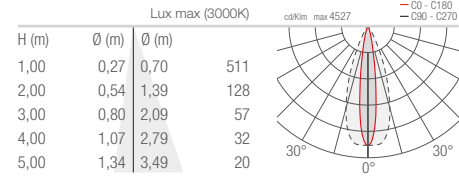

D - Diffuse

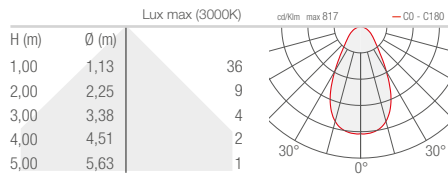

**BRIGHT 2.4
2.5**

Z - Asymmetrical 8° CRI 80

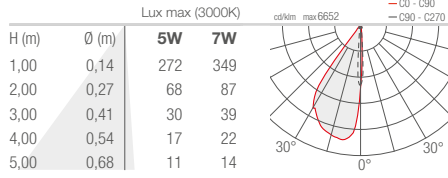

V - 8° CRI 80

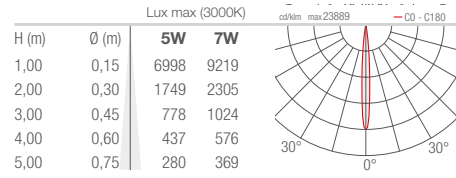

T - 11° CRI 80

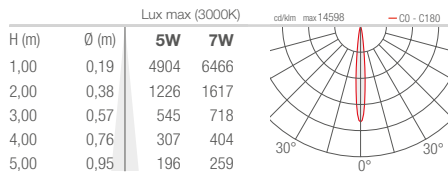

S - 17° CRI 80

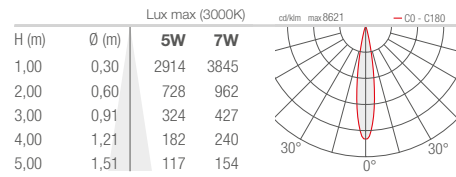

P - 21° sharp CRI 80

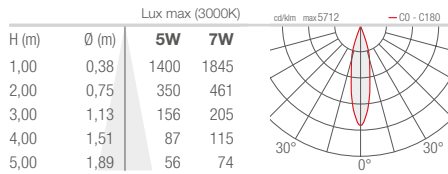

M - 34° CRI 80

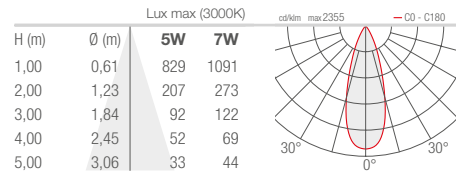

L - 45° CRI 80

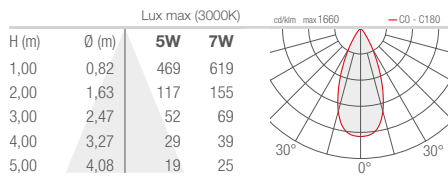

J - 47° CRI 80

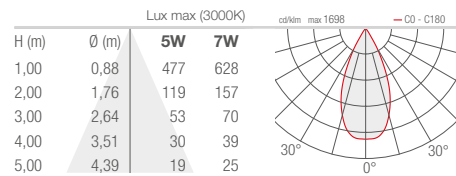

Q - 61° sharp CRI 80

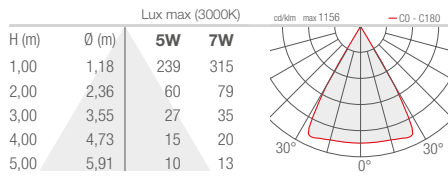

K - 68° CRI 80

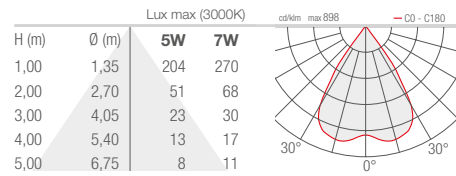

W - 13°x52° CRI 80

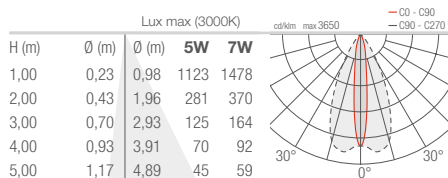

D - Diffuse CRI 80

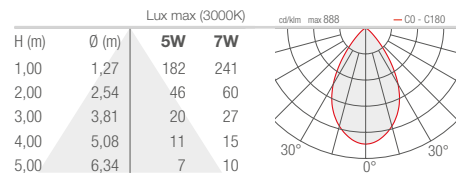

BRIGHT 2.8 2.9

S - 8°

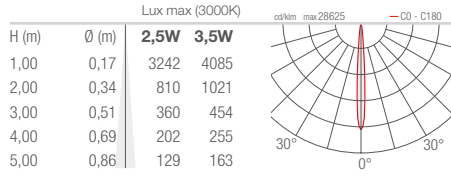

M - 20°

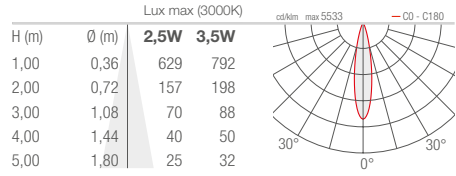

P - 36° sharp

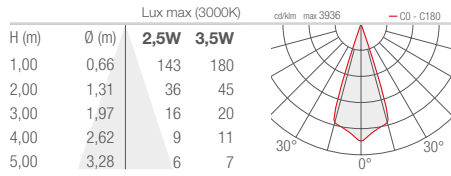

L - 41°

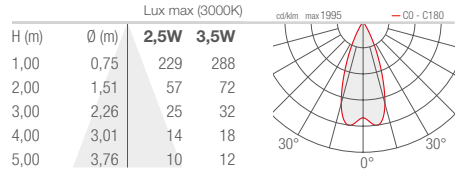

Q - 68° sharp

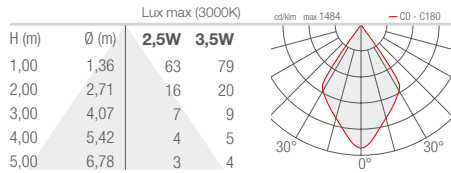

W - 10°x44°

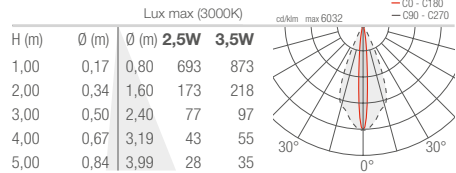



BRIGHT 3.F

S - 16° CRI 80

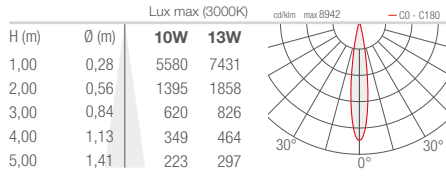

M - 21° CRI 80

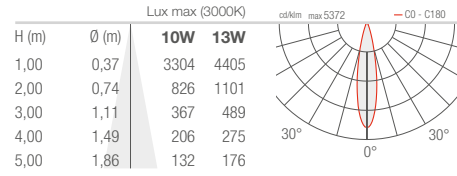

L - 38° CRI 80

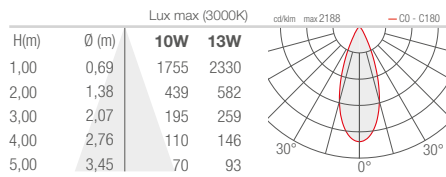

K - 55° CRI 80

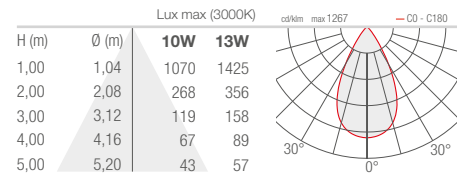

P - 58° sharp CRI 80

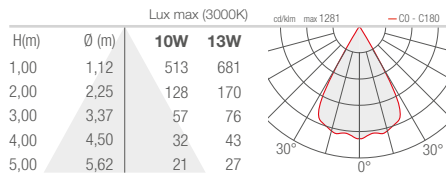

W - 16°x69° adjustable CRI 80

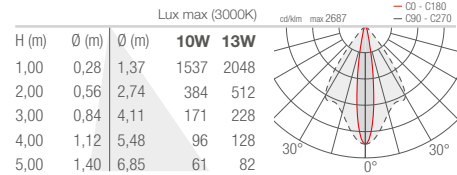

D - Diffuse CRI 80

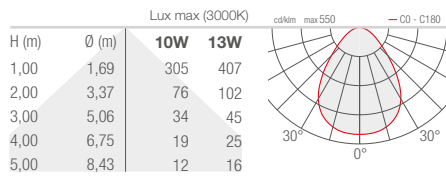

BRIGHT 3.G

S - 12° CRI 80

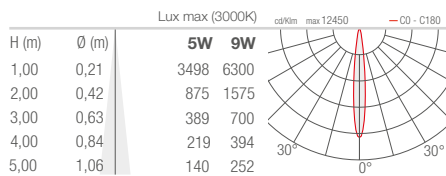

M - 20° CRI 80

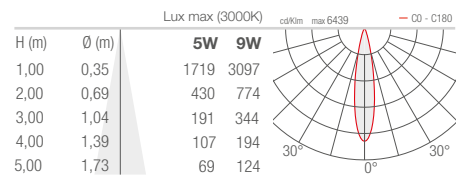

L - 35° CRI 80

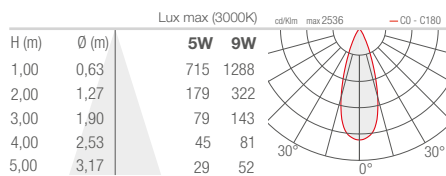

K - 57° CRI 80

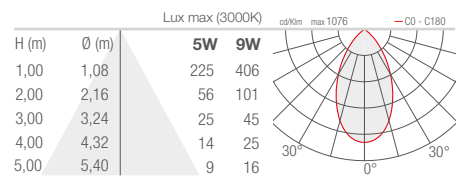

BRIGHT 3.H

S - 18°

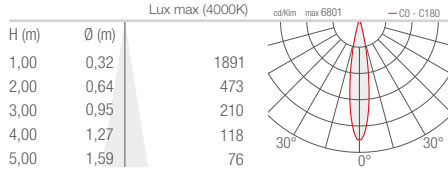

M - 32°

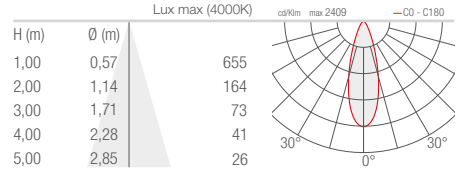

L - 58°

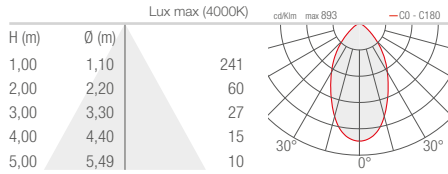

BRIGHT 5.F

V- 10° CRI 80

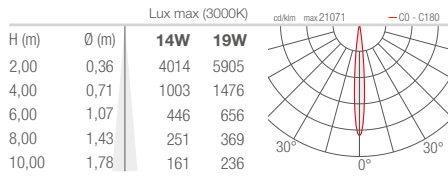

T- 12° CRI 80

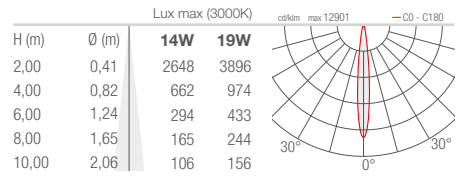

S- 18° CRI 80

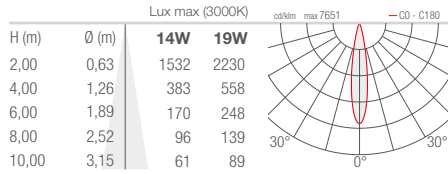

M- 31° CRI 80

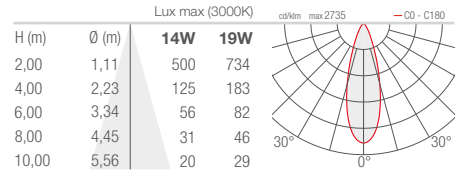

L- 35° CRI 80

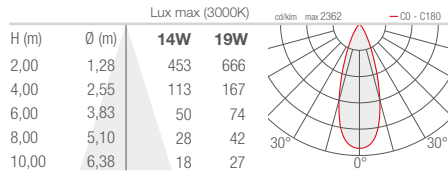

K- 56° CRI 80

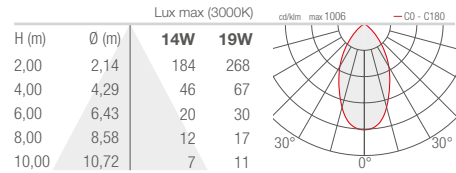

W- 15°x47° CRI 80

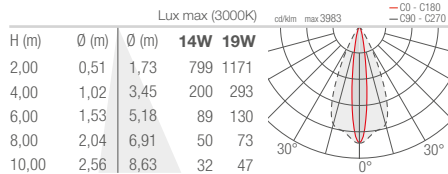

X- 67°x11° adjustable CRI 80

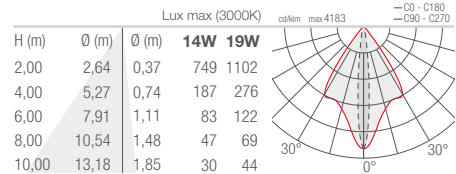

BRIGHT 5.G

S - 12° CRI 80

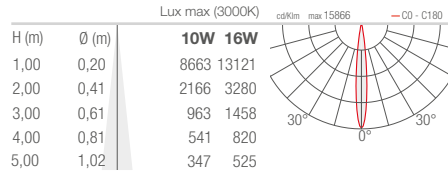

M - 31° CRI 80

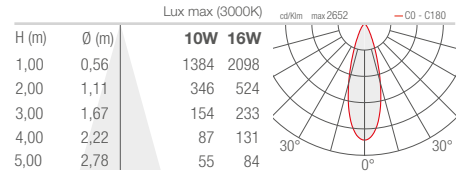

L - 38° CRI 80

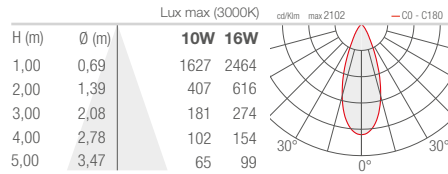

K - 55° CRI 80

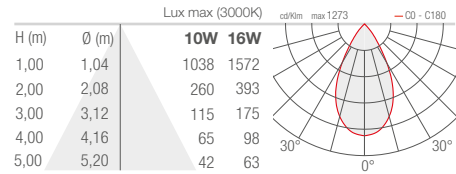

BRIGHT 5.H

S - 20°

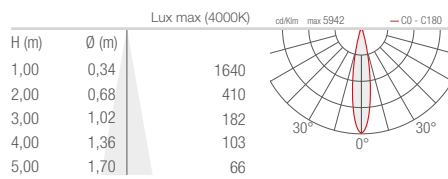

M - 34°

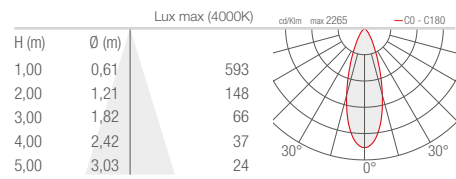

L - 61°

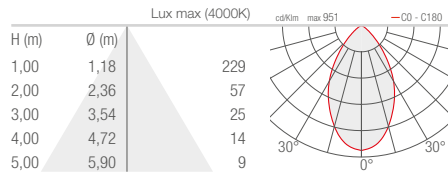

BRIGHT

OUTDOOR STEP LIGHTS

BRIGHT 1.A 1.B

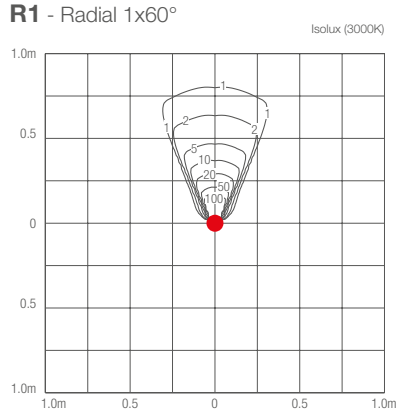

Bright 1.A **2W**
Bright 1.B **3.5W**

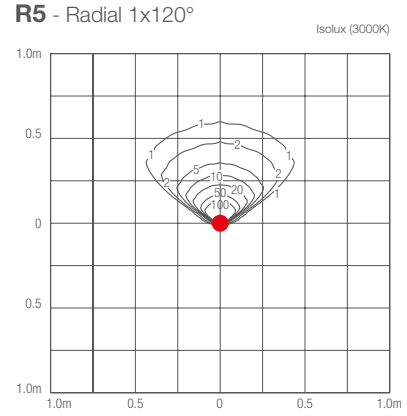

Bright 1.A **2W**
Bright 1.B **3.5W**

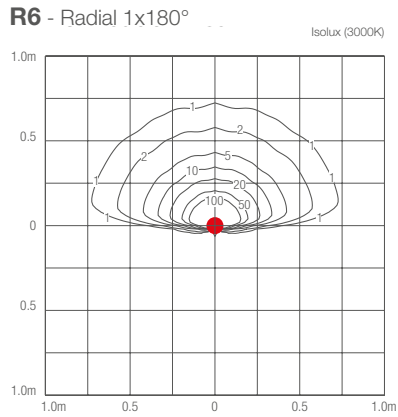

Bright 1.A **2W**
Bright 1.B **3.5W**

BRIGHT 4.7

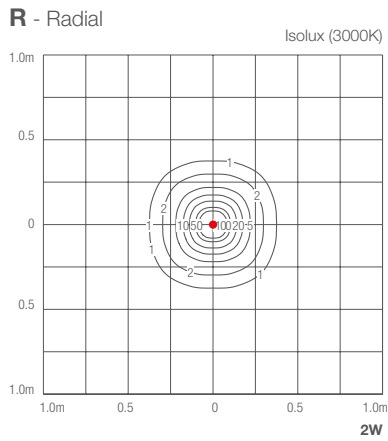

BRIGHT 9.7

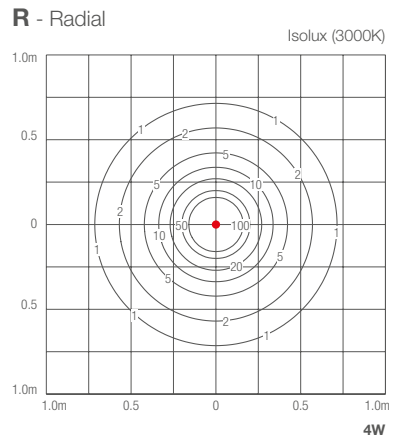



UNDERWATER RECESSED

BRIGHT 1.0 316L 1.6 316L

S - 10°

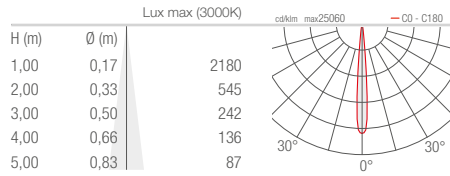

M - 21°

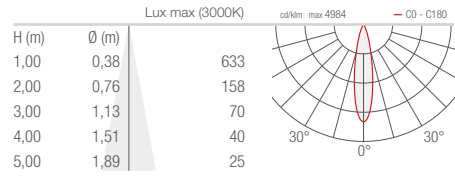

L - 43°

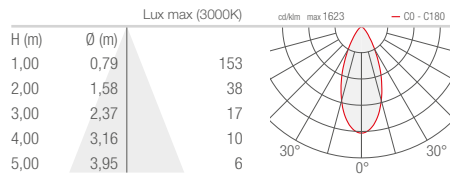

D - Diffuse

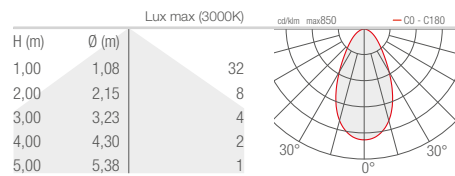

BRIGHT 2.0 316L 2.6 316L

S - 10°

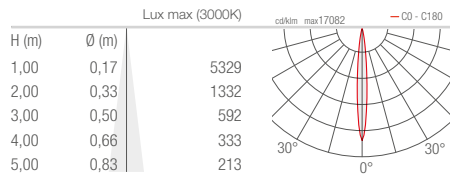

M - 24°

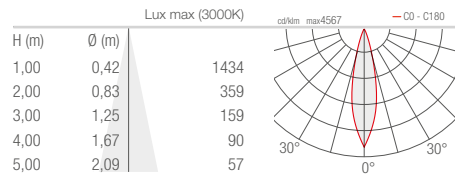

L - 38°

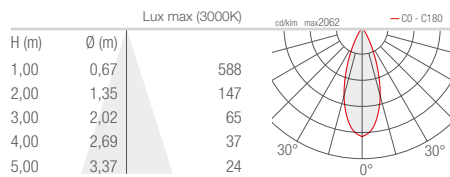

BRIGHT 3.0 316L S - 11°

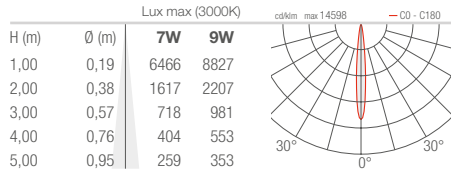

M - 34°

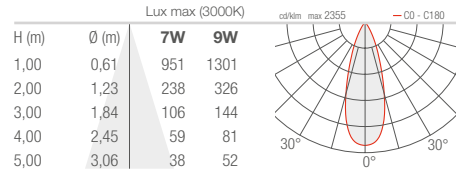

L - 45°

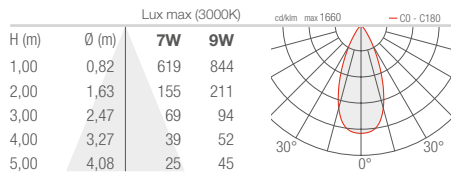

K - 68°

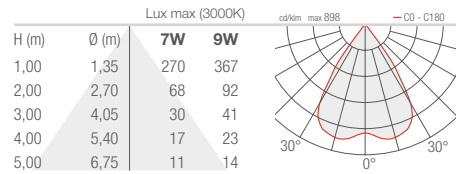

W - 13°x52°

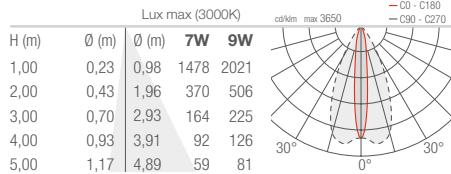

BRIGHT 5.0 316L S - 10°

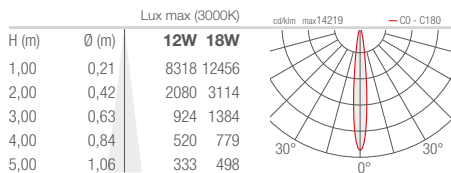

M - 20°

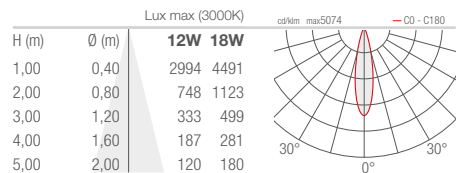

L - 40°

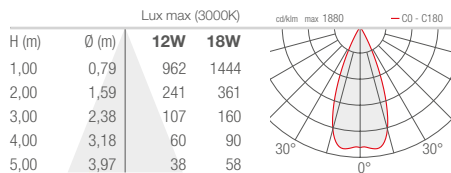

OUTDOOR WALL MOUNTED

BROM 1.0

S - 10°

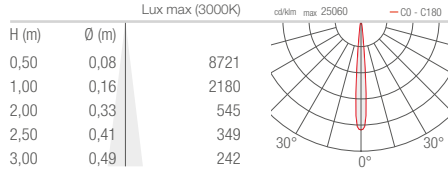

M - 20°

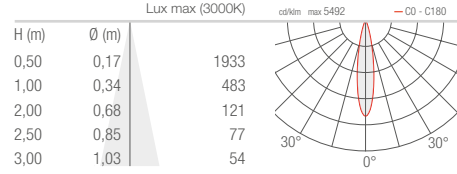

L - 40°

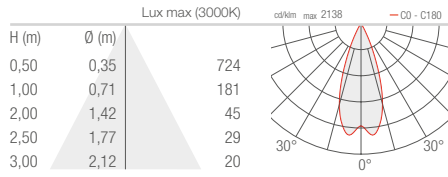

W - 10°x45°

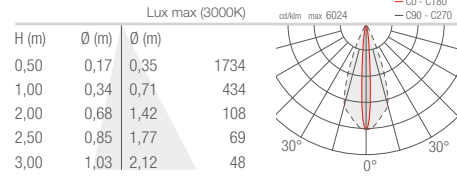

BROM 3.0

S - 12°

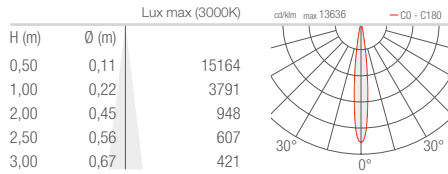

M - 20°

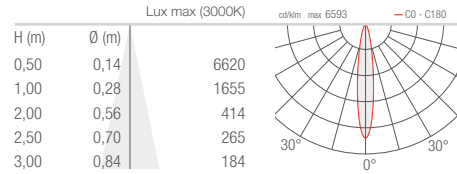

L - 35°

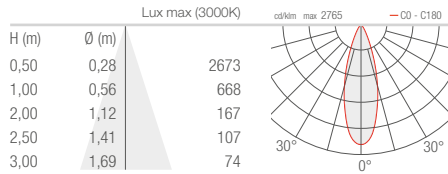

CAMEO 1.0 1.1 1.6 1.7

S - 17°

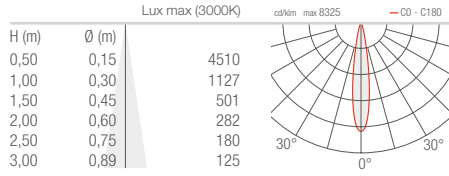

M - 29°

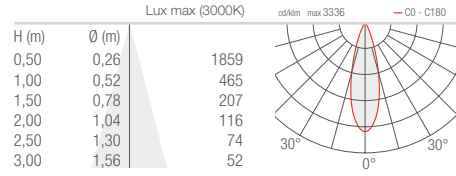

P - 48° sharp

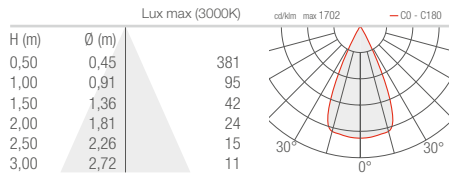

L - 52°

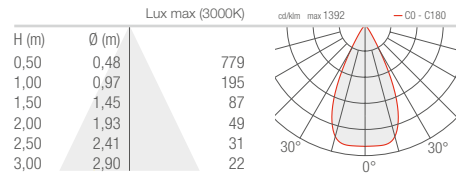

W - 16°x34°

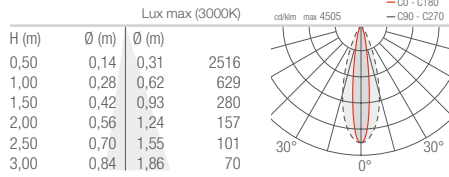

CAMEO 1.2 1.8

R1 - 8° (8°-40°)

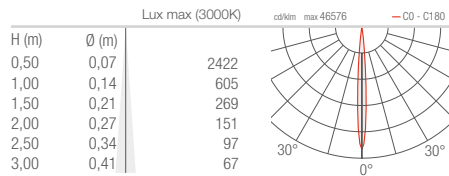

R1 - 40° (8°-40°)

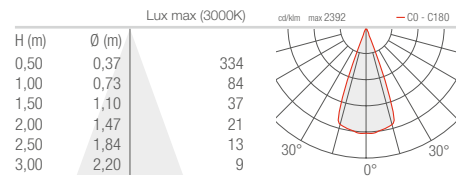

CAMEO 2.6 2.7

S - 11°

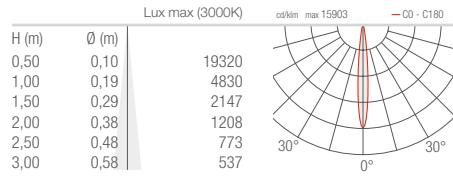

M - 17°

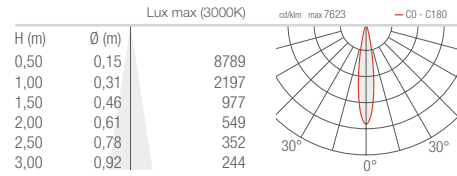

P - 19° sharp

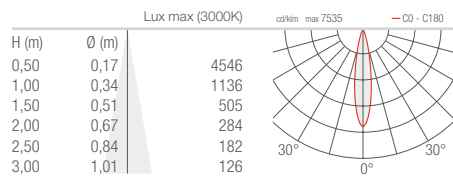

L - 32°

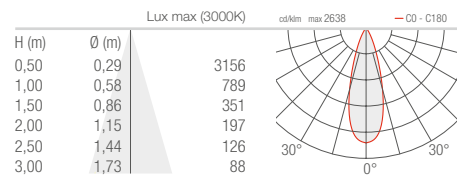

J - 65°

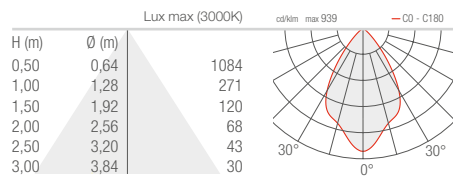

W - 13°x43°

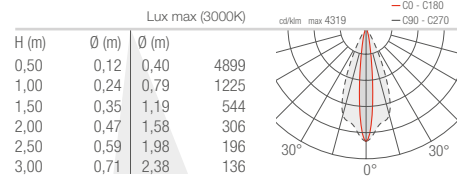

CAMEO 2.8

R1 - 8° (8°-58°)

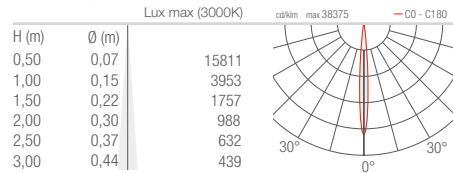

R1 - 58° (8°-58°)

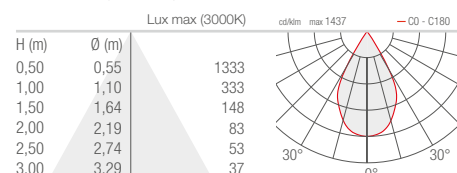

CIAK 1.0

1.1
1.6
1.7

S - 17°

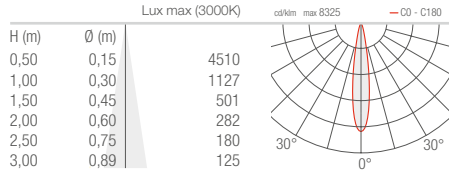

M - 29°

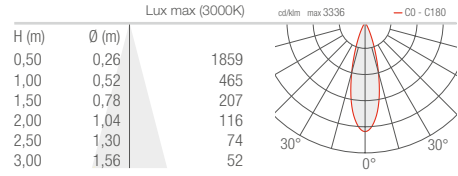

P - 48° sharp

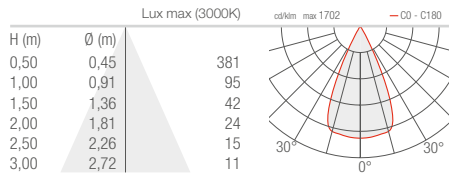

L - 52°

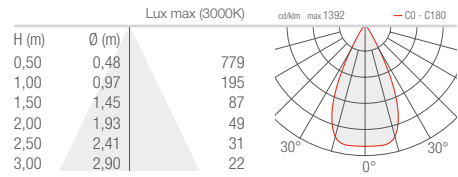

W - 16°x34°

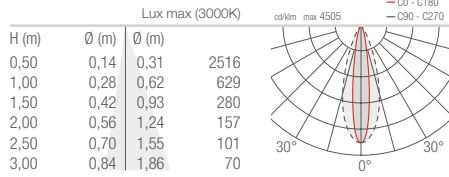

CIAK 2.6

2.7

S - 11°

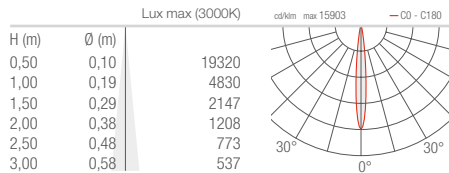

M - 17°

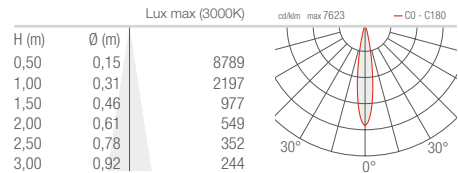

P - 19° sharp

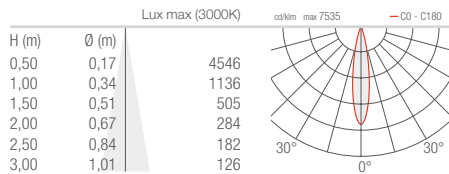

L - 32°

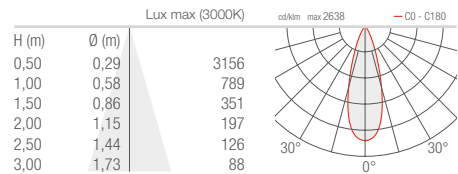

J - 65°

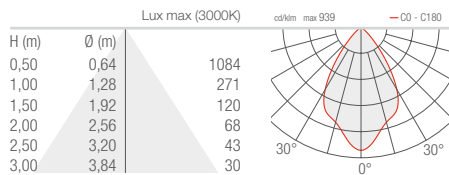

W - 13°x43°

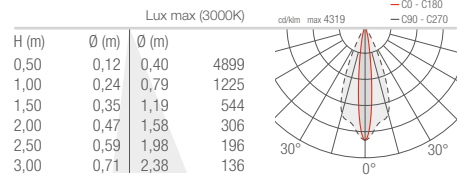



OUTDOOR LINEAR PROFILES

COLORADO 1.0

2.0
3.0

S - 12° CRI 80

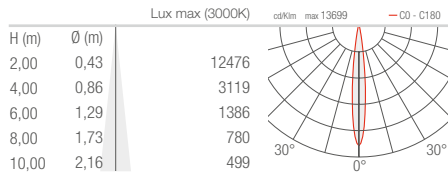

M - 30° CRI 80

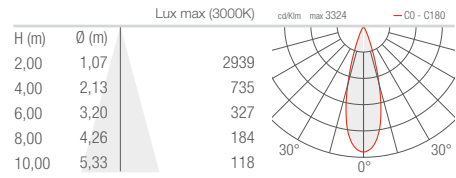

L - 45° CRI 80

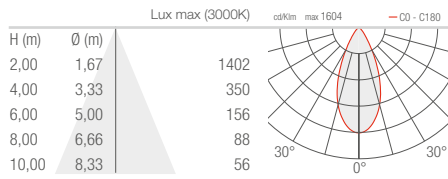

K - 76° CRI 80

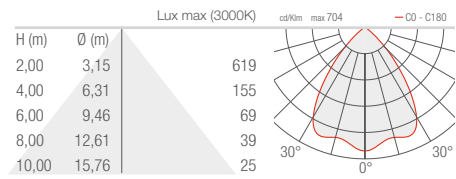

W - 15°x50° CRI 80

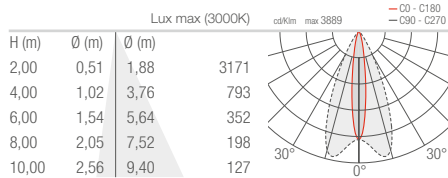

D - Diffuse CRI 80

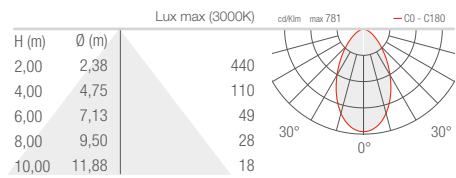

COLORADO 4.0

5.0

6.0

S - 15°

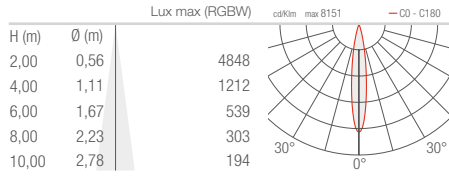

M - 25°

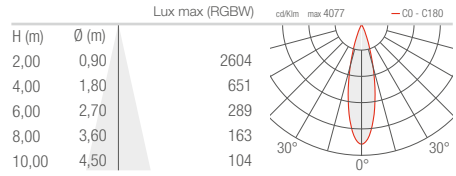

L - 37°

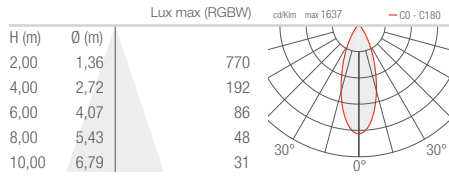

W - 13°x65°

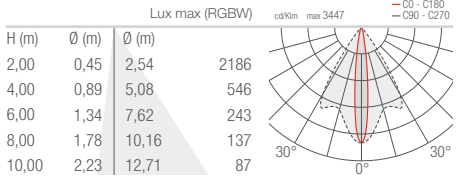

X - 65°x13° (Colorado 6.0)

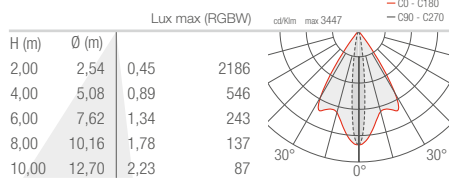

D - Diffuse

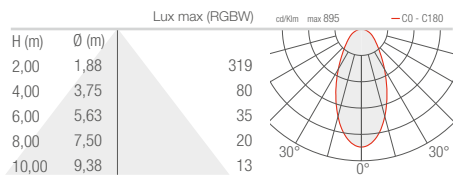



INDOOR RECESSED

COMBINA D 1.0 1.1

S - 16° CRI 90 - flat, round cover

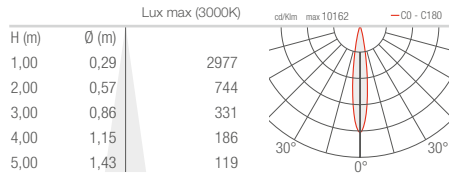

S - 16° CRI 90 - flat, square cover

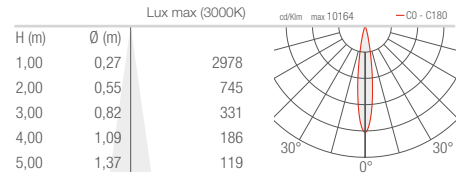

S - 16° CRI 90 - shallow, round cover

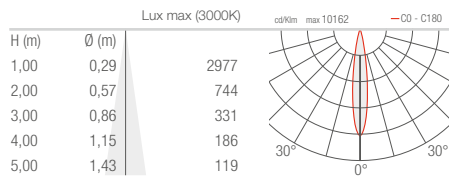

S - 16° CRI 90 - shallow, square cover

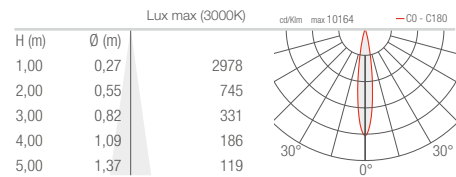

S - 16° CRI 90 - deep, round cover

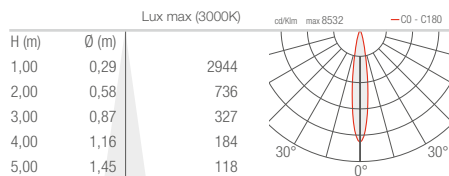

S - 16° CRI 90 - deep, square cover

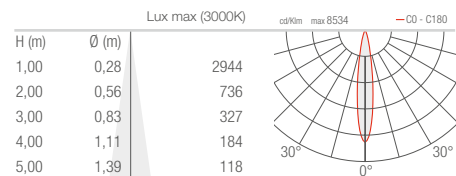

M - 22° CRI 90 - flat, round cover

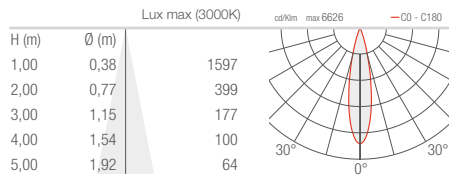

M - 22° CRI 90 - flat, square cover

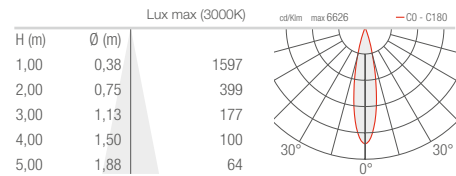

M - 22° CRI 90 - shallow, round cover

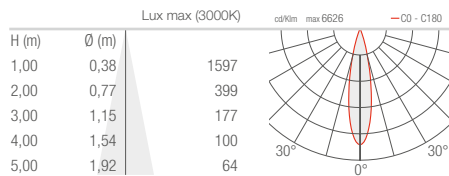

M - 22° CRI 90 - shallow, square cover

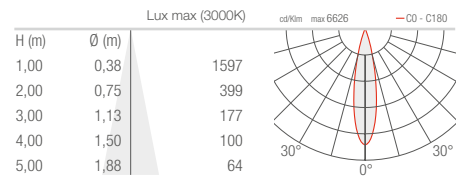

M - 23° CRI 90 - deep, round cover

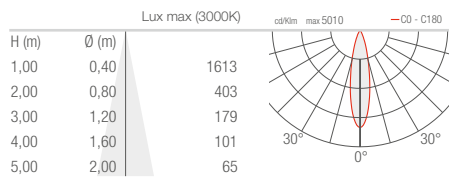

M - 23° CRI 90 - deep, square cover

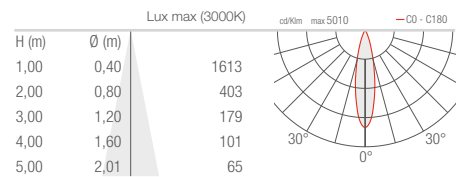

COMBINA D 1.0 1.1

L - 33° CRI 90 - flat, round cover

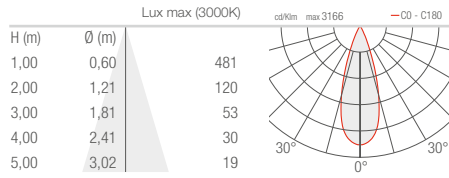

L - 33° CRI 90 - flat, square cover

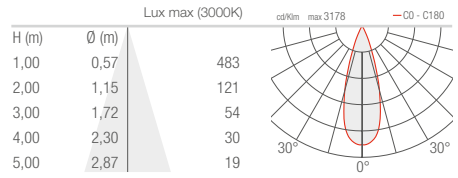

L - 33° CRI 90 - shallow, round cover

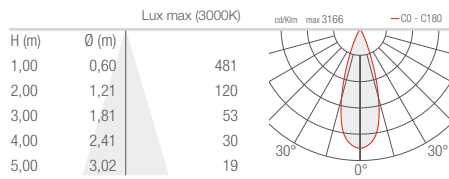

L - 33° CRI 90 - shallow, square cover

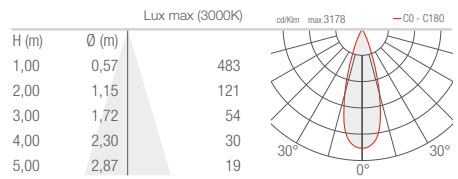

L - 42° CRI 90 - deep, round cover

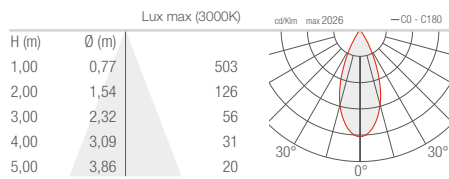

L - 42° CRI 90 - deep, square cover

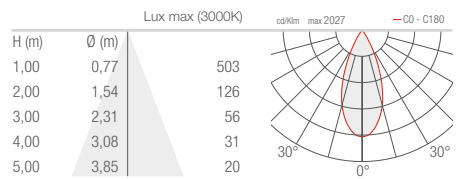

COMBINA D 2.0 2.1

S - 25° CRI 90 - flat, round cover

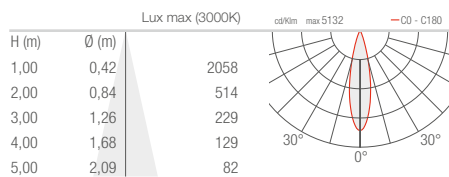

S - 25° CRI 90 - flat, square cover

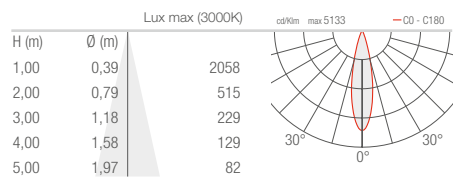

S - 25° CRI 90 - shallow, round cover

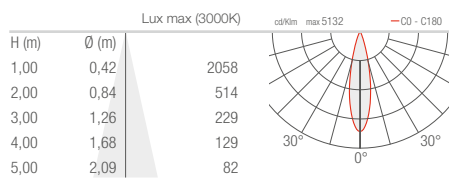

S - 25° CRI 90 - shallow, square cover

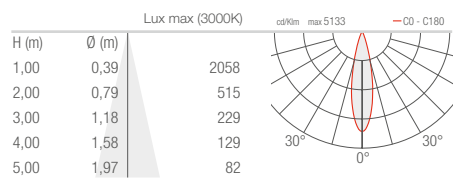

S - 25° CRI 90 - deep, round cover

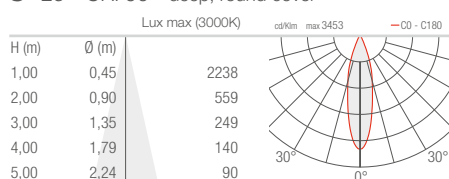

S - 25° CRI 90 - deep, square cover

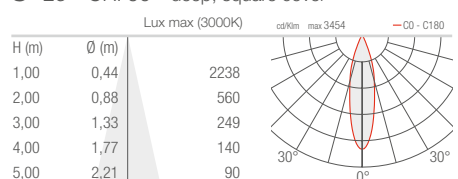

COMBINA D 2.0 2.1

M - 30° CRI 90 - flat, round cover

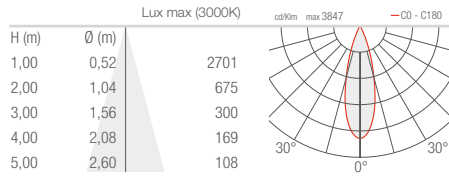

M - 30° CRI 90 - flat, square cover

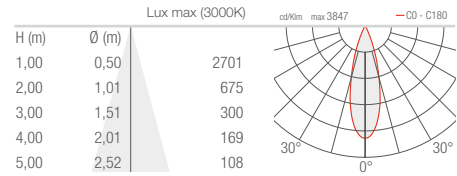

M - 30° CRI 90 - shallow, round cover

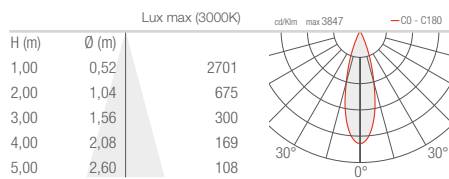

M - 30° CRI 90 - shallow, square cover

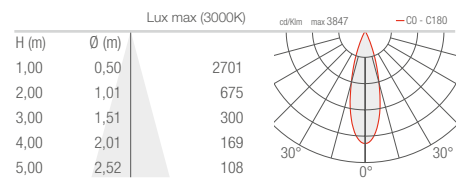

M - 30° CRI 90 - deep, round cover

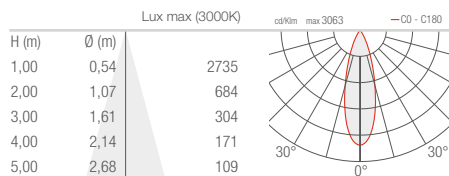

M - 30° CRI 90 - deep, square cover

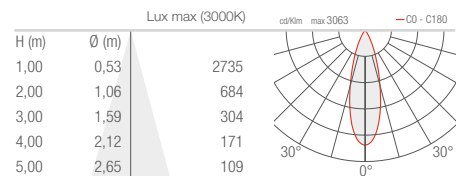

L - 36° CRI 90 - flat, round cover

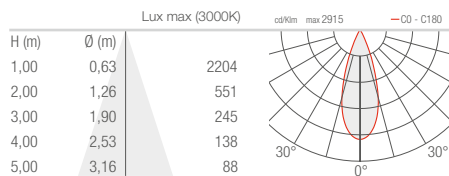

L - 36° CRI 90 - flat, square cover

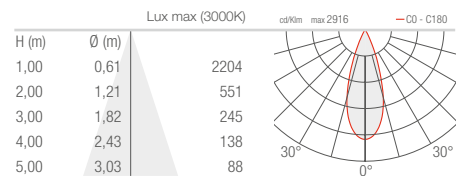

L - 36° CRI 90 - shallow, round cover

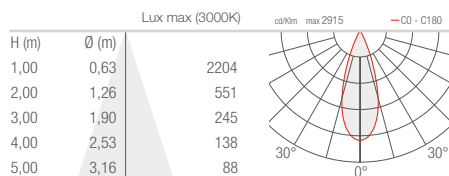

L - 36° CRI 90 - shallow, square cover

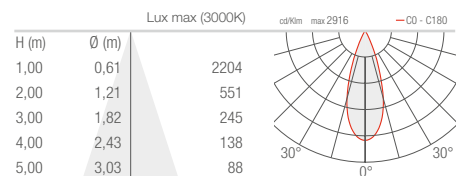

L - 36° CRI 90 - deep, round cover

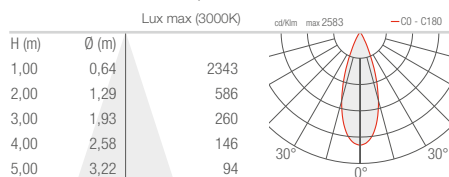

L - 36° CRI 90 - deep, square cover

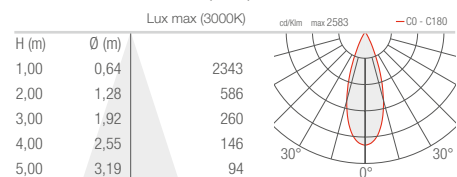

COMBINA D 3.0
3.1

S - 18° CRI 90 - flat, round cover

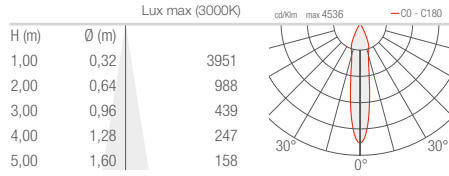

S - 18° CRI 90 - flat, square cover

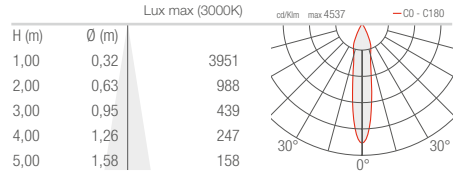

S - 18° CRI 90 - shallow, round cover

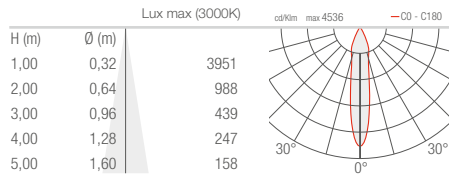

S - 18° CRI 90 - shallow, square cover

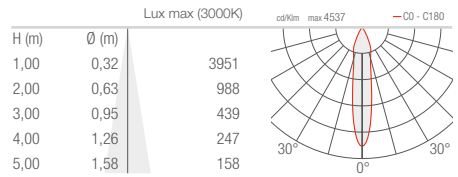

S - 18° CRI 90 - deep, round cover

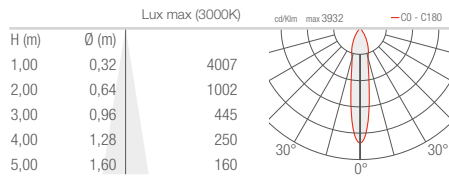

S - 18° CRI 90 - deep, square cover

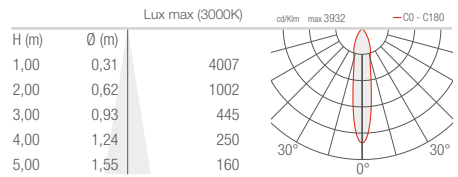

M - 29° CRI 90 - flat, round cover

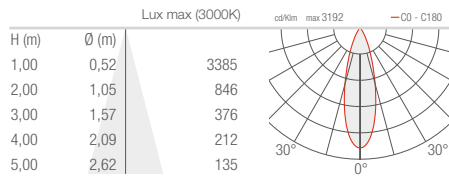

M - 29° CRI 90 - flat, square cover

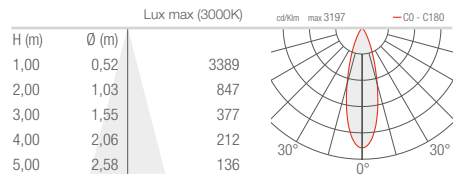

M - 29° CRI 90 - shallow, round cover

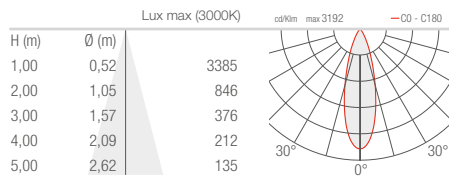

M - 29° CRI 90 - shallow, square cover

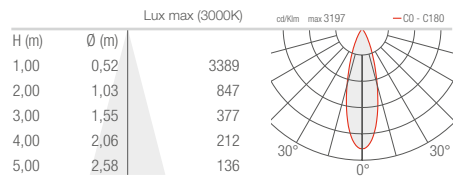

M - 29° CRI 90 - deep, round cover

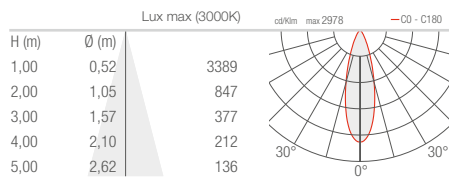

M - 29° CRI 90 - deep, square cover

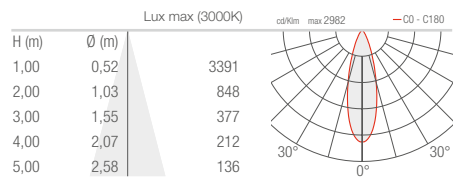

COMBINA D 3.0
3.1

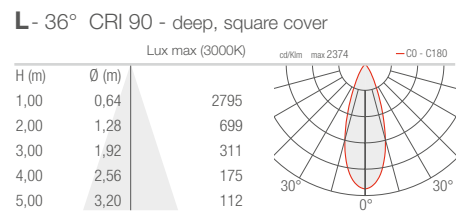
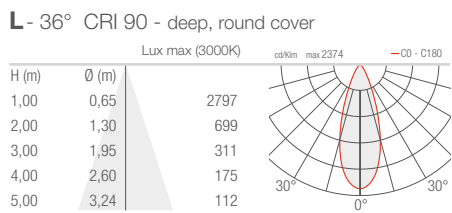
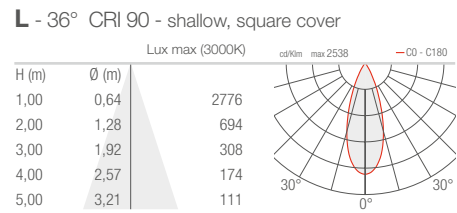
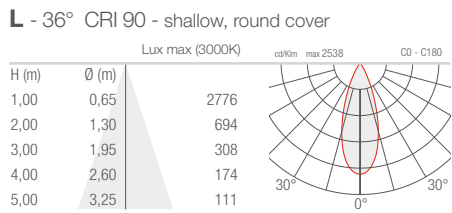
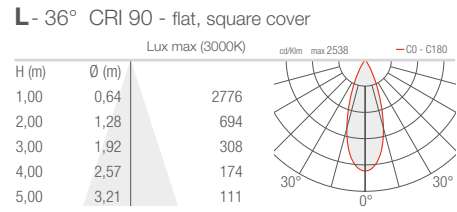
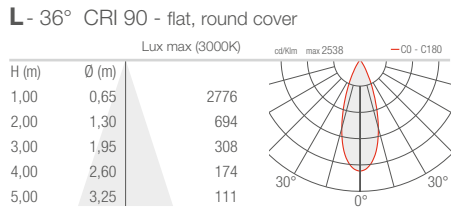

COMBINA D 4.0
4.1

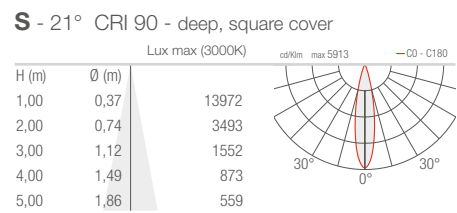
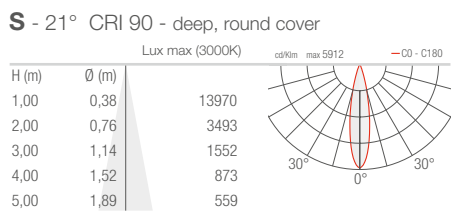
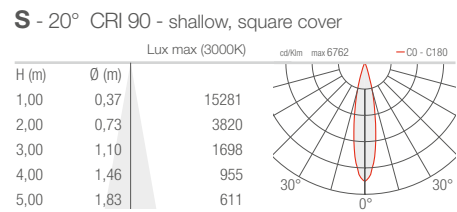
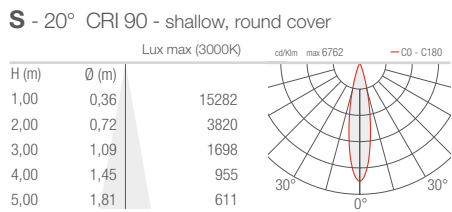
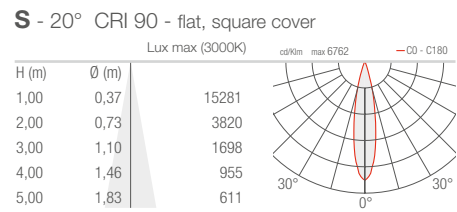
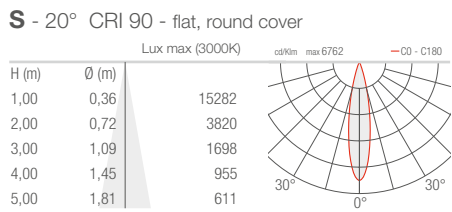

COMBINA D 4.0 4.1

M - 29° CRI 90 - flat, round cover

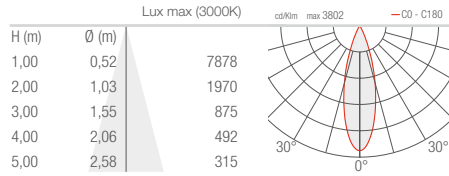

M - 29° CRI 90 - flat, square cover

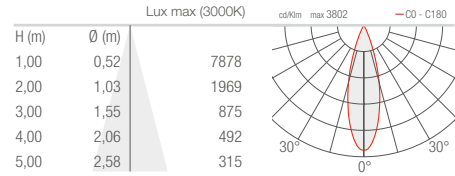

M - 29° CRI 90 - shallow, round cover

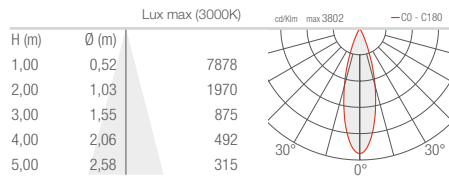

M - 29° CRI 90 - shallow, square cover

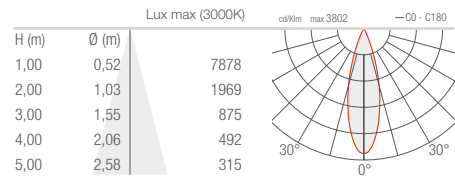

M - 30° CRI 90 - deep, round cover

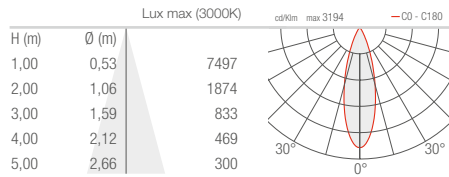

M - 30° CRI 90 - deep, square cover

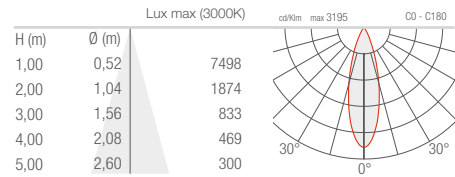

L - 38° CRI 90 - flat, round cover

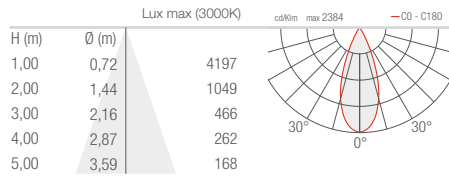

L - 38° CRI 90 - flat, square cover

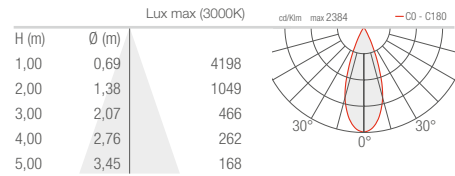

L - 38° CRI 90 - shallow, round cover

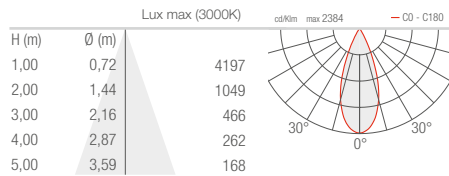

L - 38° CRI 90 - shallow, square cover

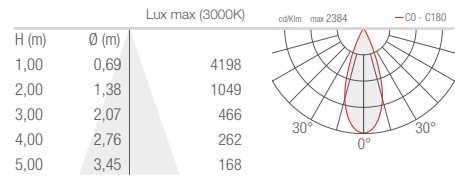

L - 41° CRI 90 - deep, round cover

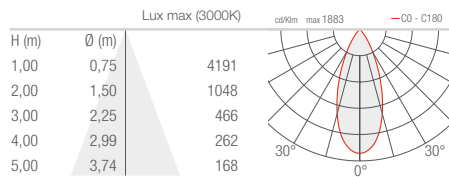

L - 41° CRI 90 - deep, square cover

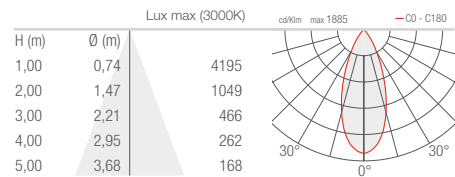

KIT COMBINA D
1.0

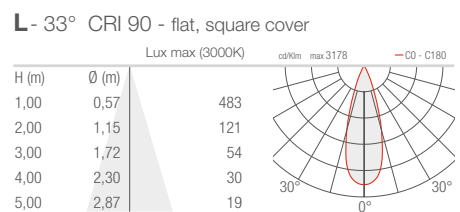
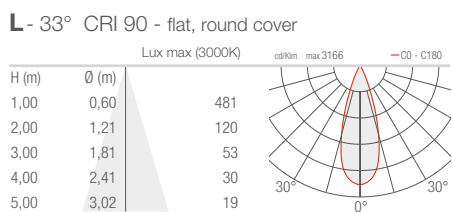
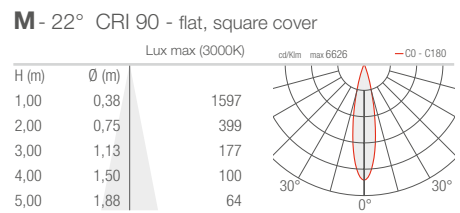
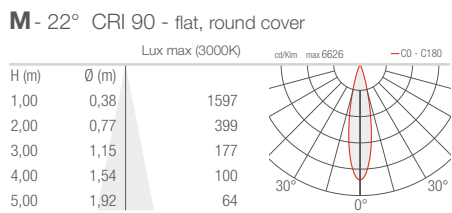
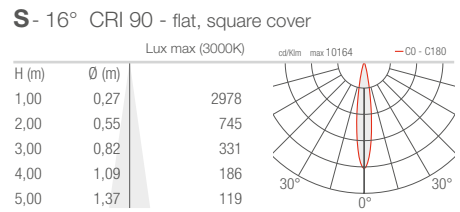
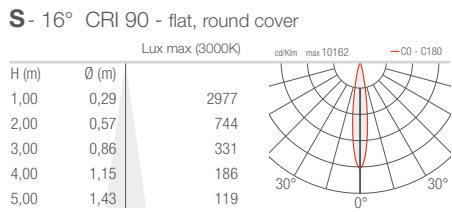

KIT COMBINA D
2.0

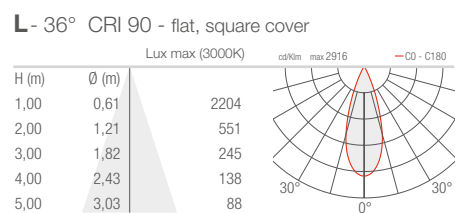
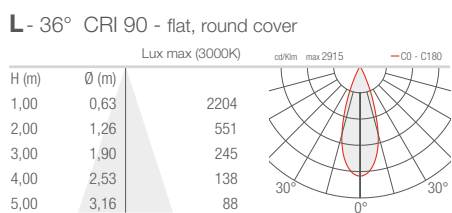
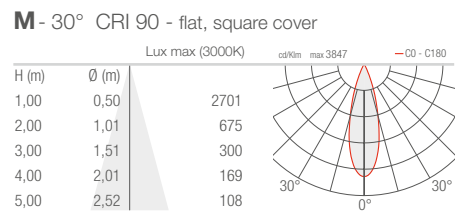
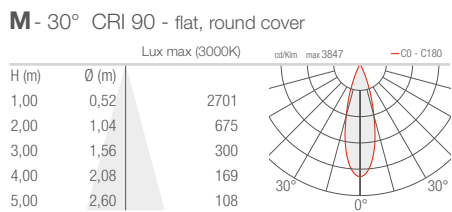
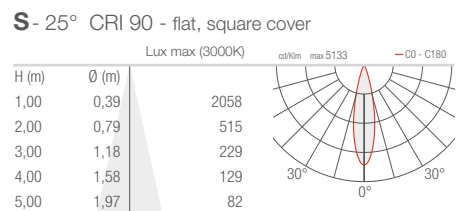
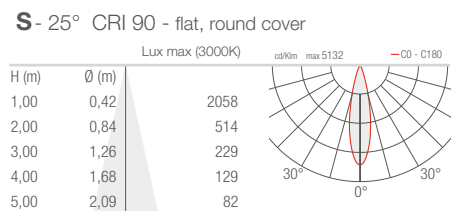

CORSO 1.0

S - 13°

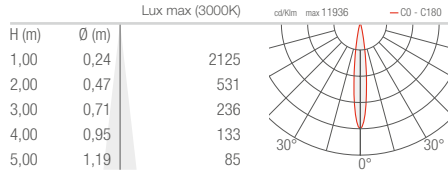

M - 28°

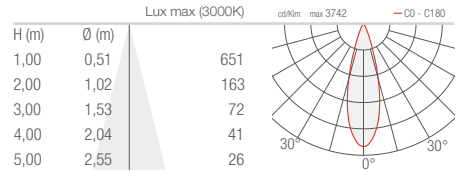

L - 37°

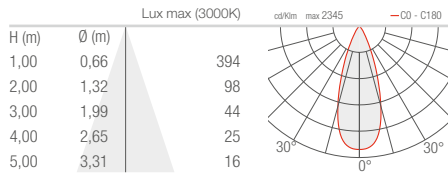

W - 12°x45°

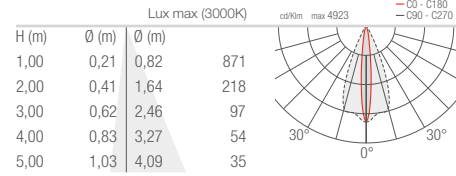

D - Diffuse

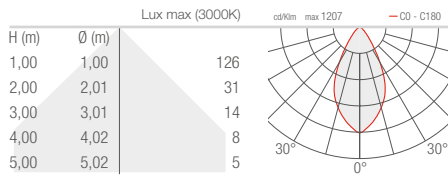

CORSO 2.0

S - 12°

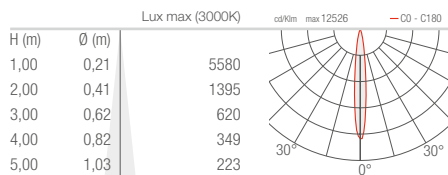

M - 36°

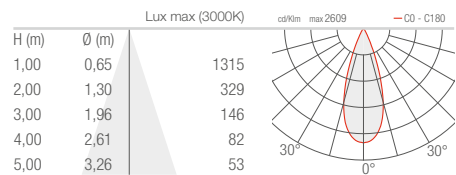

L - 70°

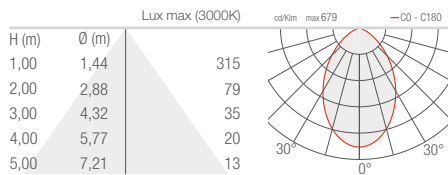

W - 14°x43°

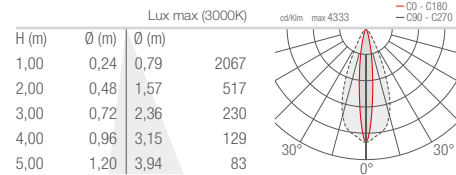

D - Diffuse

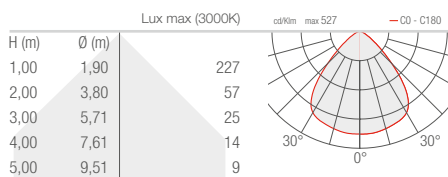

CORSO 3.0

S - 13°

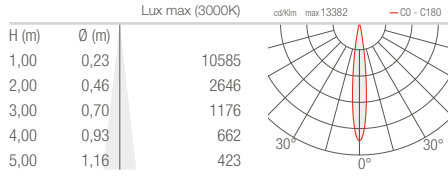

M - 40°

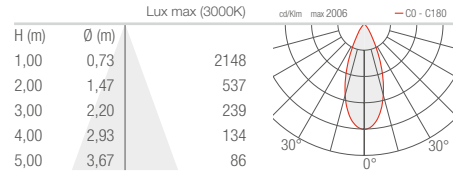

L - 58°

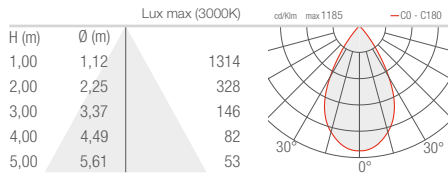

W - 12°x67°

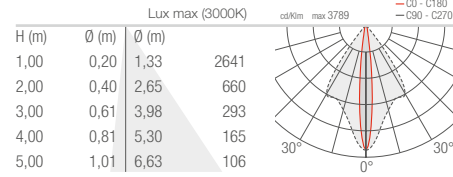

A - Asymmetrical

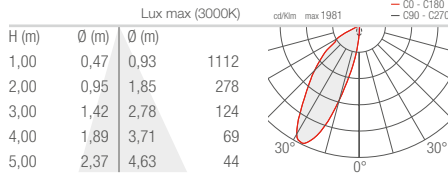

D - Diffuse

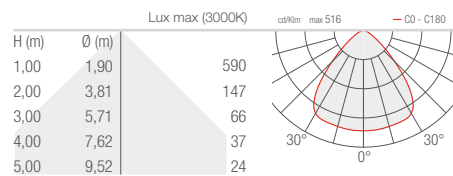

CORSO 4.0

S - 13°

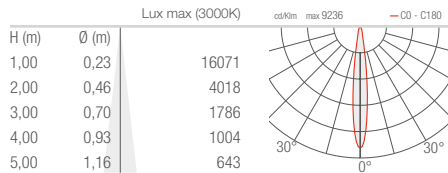

M - 38°

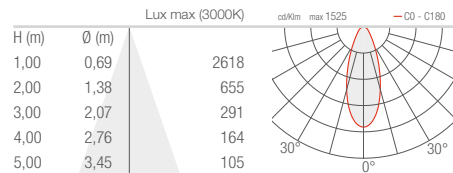

L - 71°

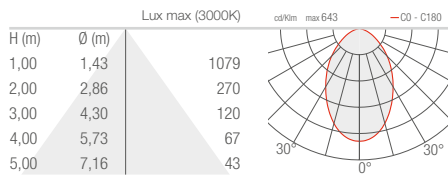

W - 14°x69°

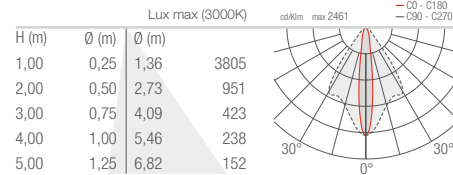

A - Asymmetrical

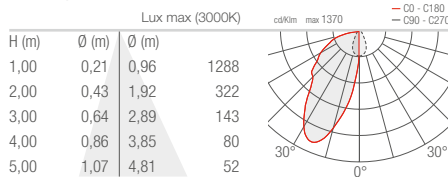

D - Diffuse

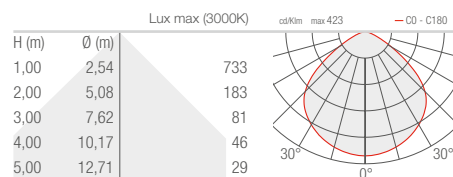

CUBE C / CUBE W

OUTDOOR CEILING MOUNTED / OUTDOOR WALL MOUNTED

CUBE C 1.2 CUBE W 1.0

S - 18°

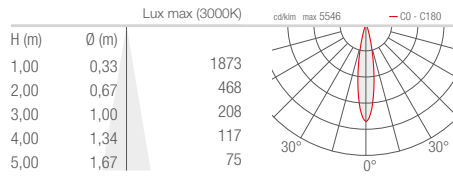

M - 28°

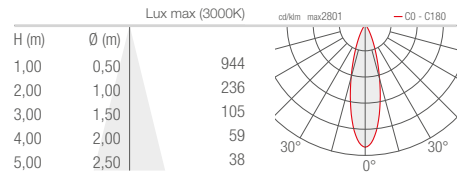

L - 36°

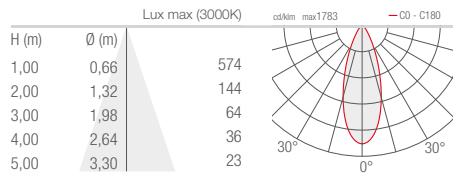

CUBE C 1.3 CUBE W 1.1

S - 18° tilted 20°

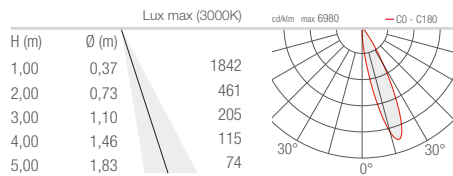

M - 28° tilted 20°

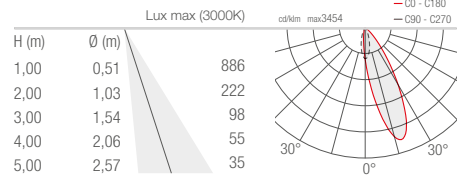

L - 36° tilted 20°

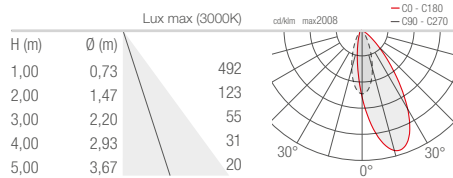



OUTDOOR PROJECTORS

DUOMO 1.0

T - 10° CRI 80

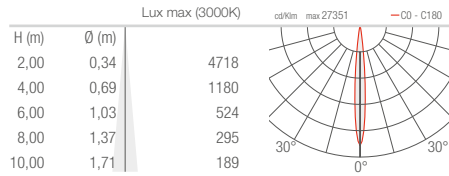

S - 14° CRI 80

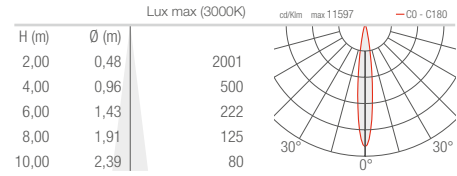

M - 30° CRI 80

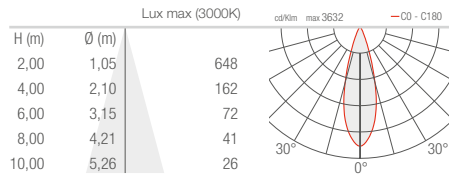

L - 35° CRI 80

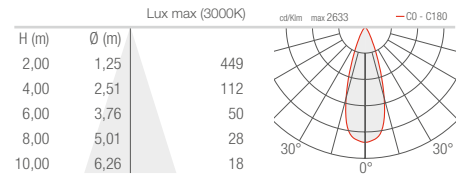

J - 43° CRI 80

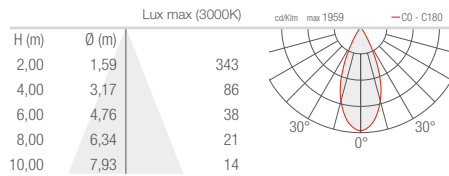

K - 63° CRI 80

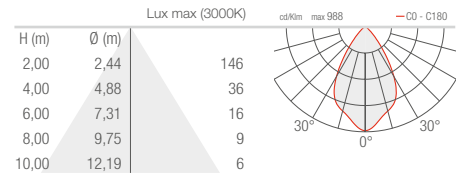

W - 18°x44° CRI 80

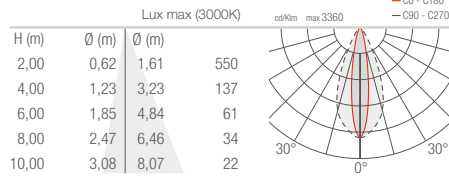

X - 44°x18° CRI 80

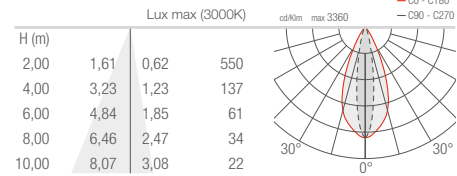

DUOMO 2.0

T - 10° CRI 80

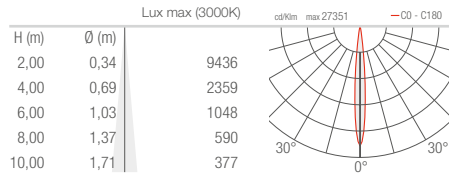

S - 14° CRI 80

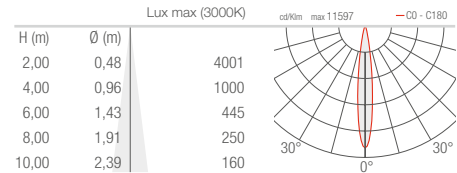

M - 30° CRI 80

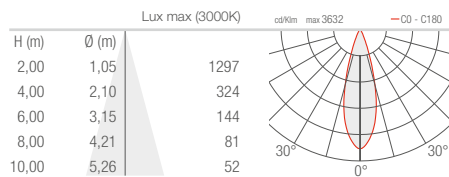

L - 35° CRI 80

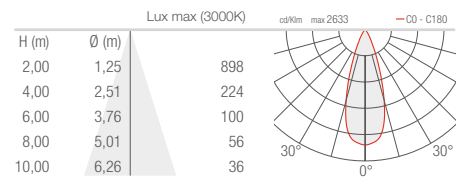

DUOMO 2.0

J - 43° CRI 80

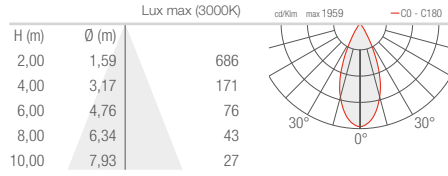

K - 63° CRI 80

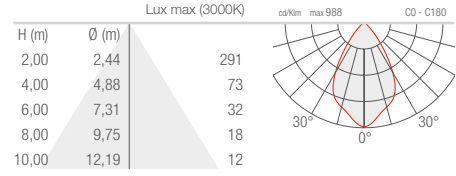

W - 18°x44° CRI 80

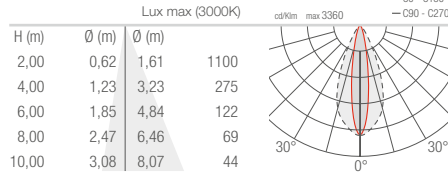

X - 44°x18° CRI 80

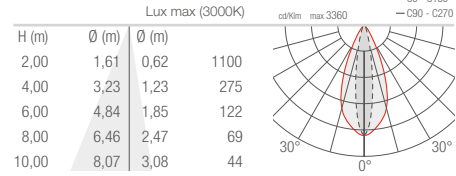

DUOMO 3.0

T - 10° CRI 80

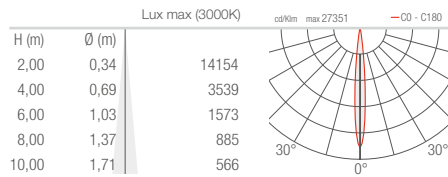

S - 14° CRI 80

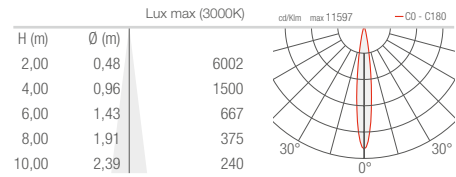

M - 30° CRI 80

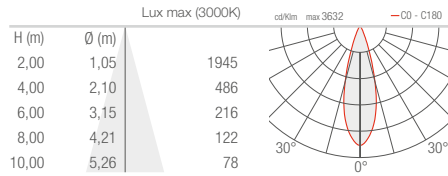

L - 35° CRI 80

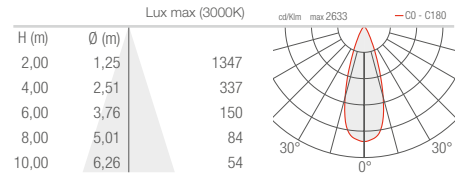

J - 43° CRI 80

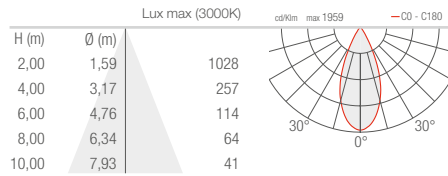

K - 63° CRI 80

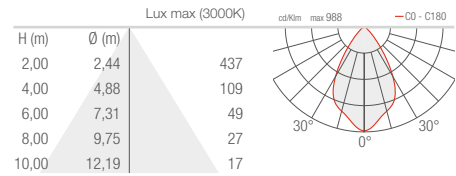

W - 18°x44° CRI 80

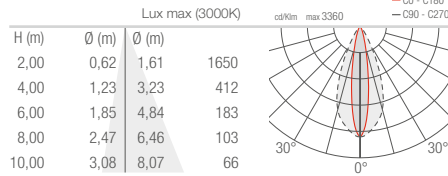

X - 44°x18° CRI 80

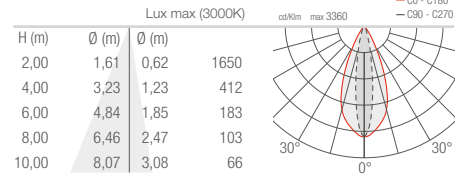

DUOMO 4.0

T - 10° CRI 80

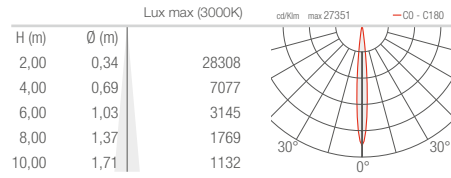

S - 14° CRI 80

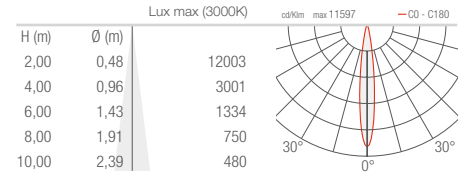

M - 30° CRI 80

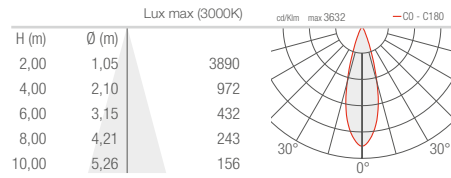

L - 35° CRI 80

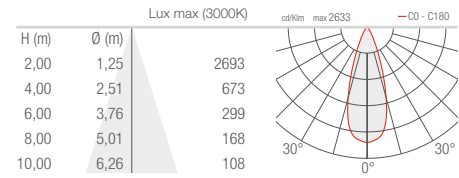

J - 43° CRI 80

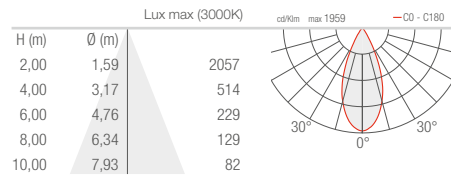

K - 63° CRI 80

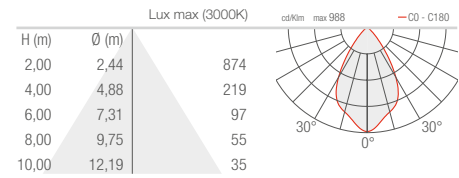

W - 18°x44° CRI 80

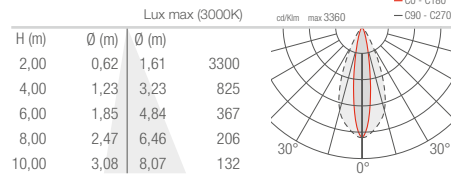

X - 44°x18° CRI 80

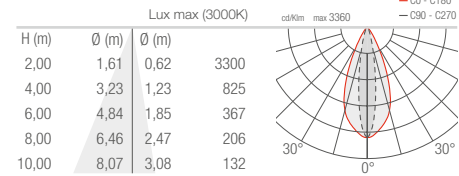

ELLA IN / ELLA OUT

INDOOR WALL MOUNTED / OUTDOOR WALL MOUNTED

ELLA IN 1.0 ELLA OUT 1.0

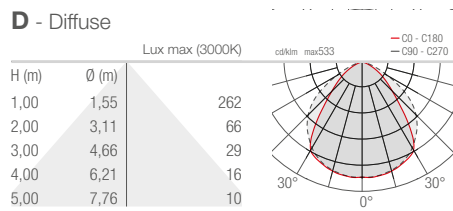

ELLA IN 2.0 ELLA OUT 2.0

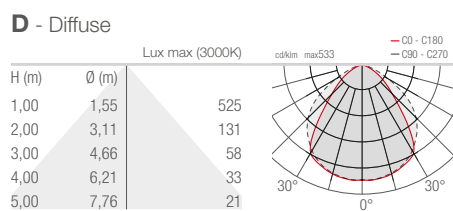

ELLA IN 3.0 ELLA OUT 3.0

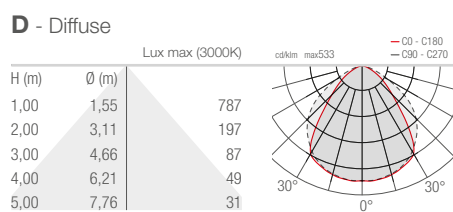

ELLO IN 1.0 ELLO OUT 1.0

D - Diffuse

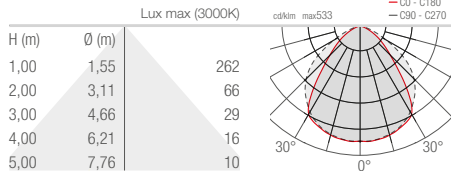

ELLO IN 2.0 ELLO OUT 2.0

D - Diffuse

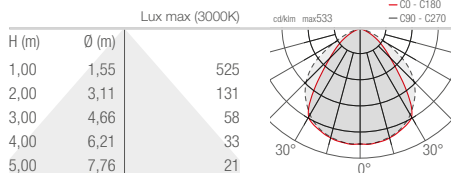

ELLO IN 3.0 ELLO OUT 3.0

D - Diffuse

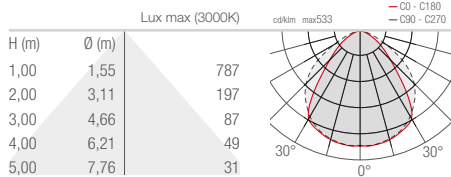

ESEM MINI 1.0

1.1
1.6
1.7

S - 14°

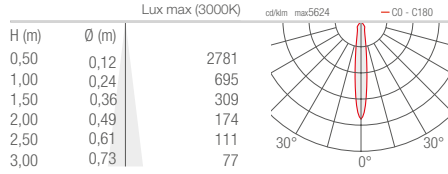

M - 27°

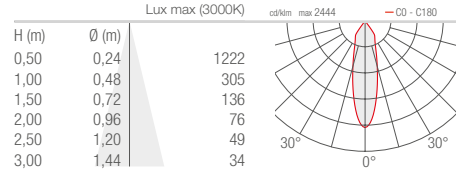

ESEM MID 1.0

1.1
1.6
1.7

S - 11°

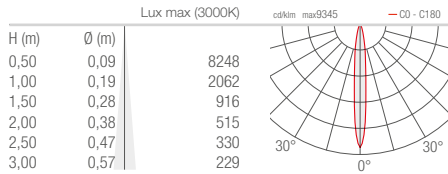

M - 22°

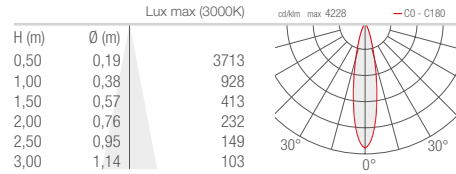

L - 30°

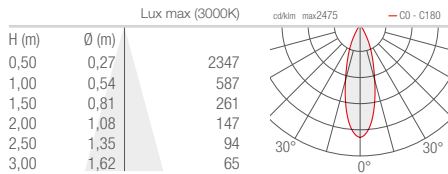

W - 20°x45°

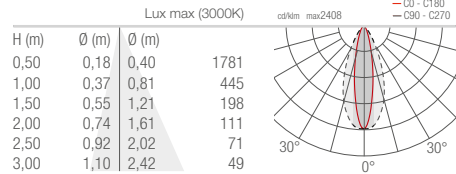

ESEM 2.0

2.6

S - 16°

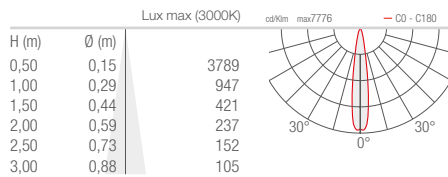

M - 36°

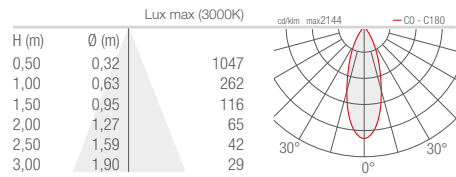

L - 80°

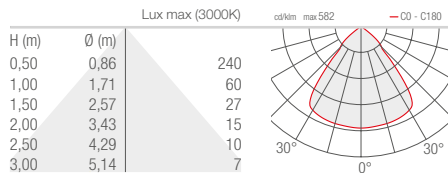

ESEM 3.0
3.1

S - 20°

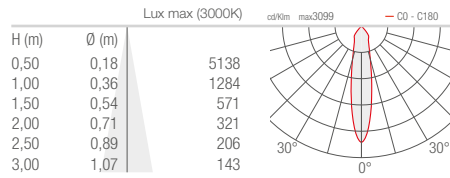

M - 30°

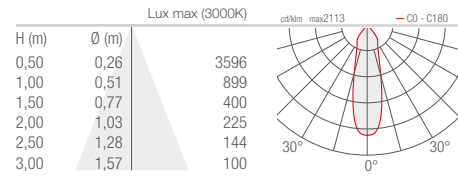

L - 54°

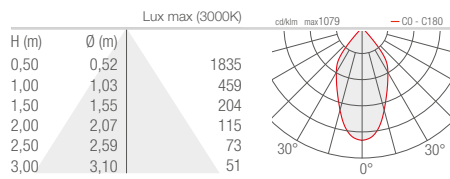

ESEM 3.2

S - 16°

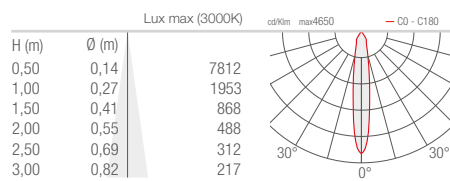

M - 29°

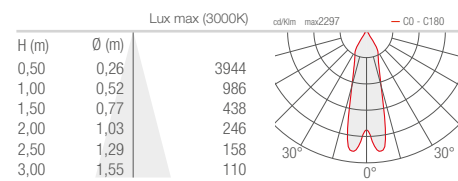

L - 46°

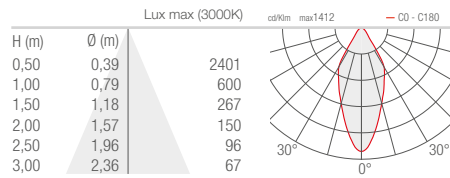

ESEM 4.0
4.1

M - 20°

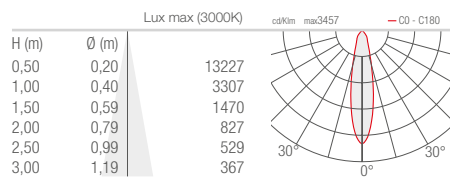

L - 40°

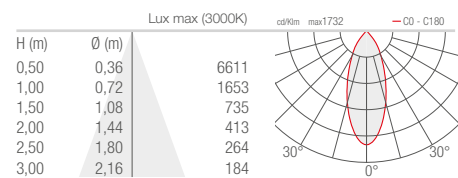

ESEM 4.2

M - 24°

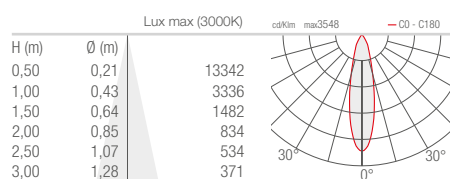

L - 37°

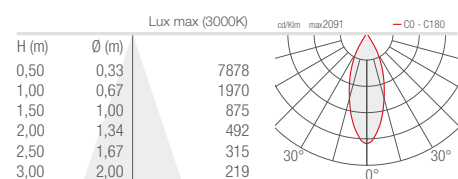

EYES

INDOOR RECESSED

EYES 1.0

1.2

1.6

1.8

F - 40°

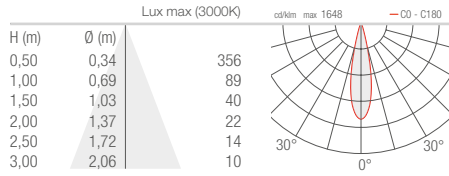

D - Diffuse

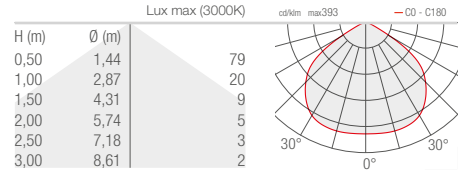

EYES 2.R

2.S

2.T

2.U

S - 17°

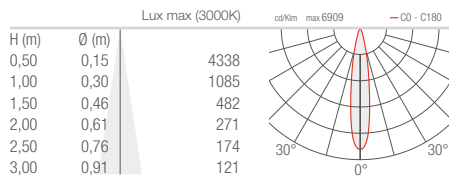

M - 23°

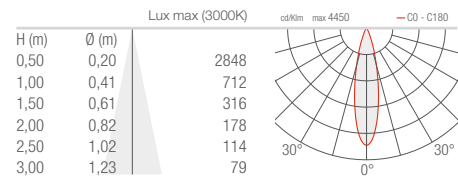

L - 36°

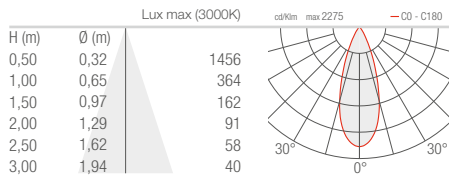

W - 20°x40°

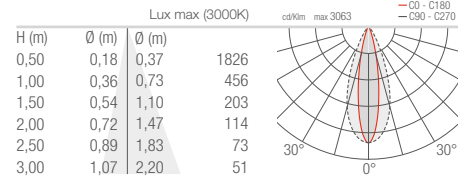

D - Diffuse

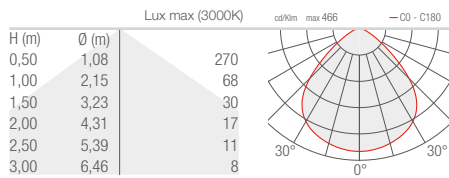



OUTDOOR PROJECTORS

FLORI 1.0 1.1

V - 9° CRI 80

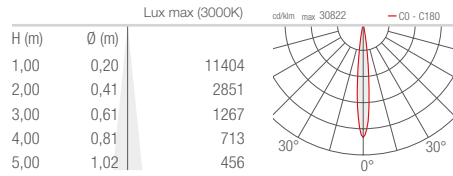

S - 15° CRI 80

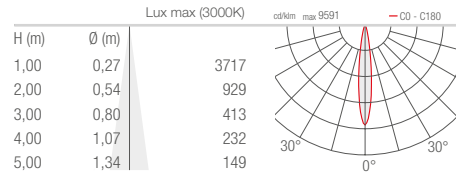

M - 31° CRI 80

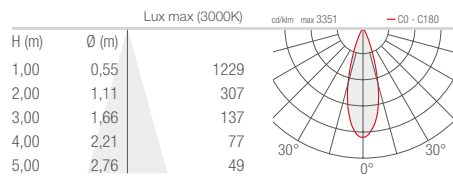

L - 36° CRI 80

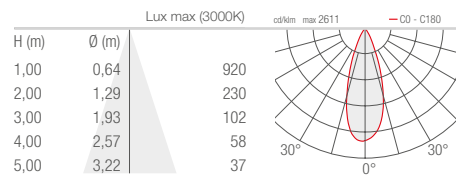

W - 10°x45° CRI 80

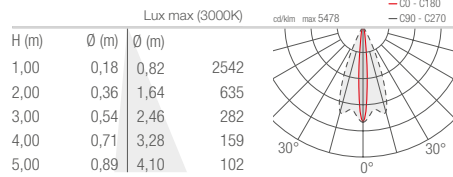

X - 45°x10° CRI 80

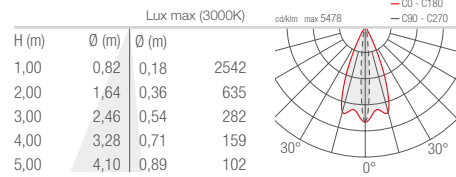

FLORI 1.2 1.3

S - 24°

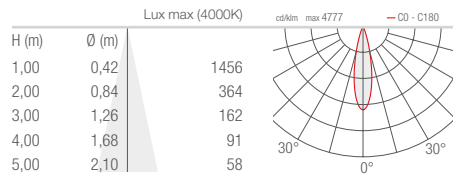

M - 33°

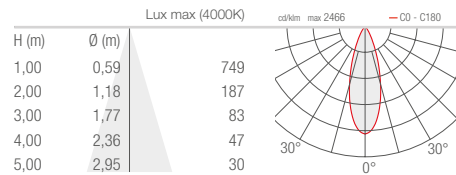

L - 60°

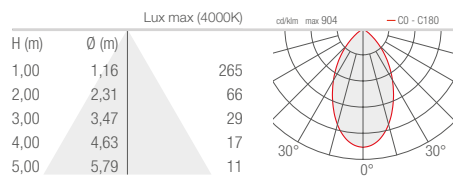

W - 32°x61°

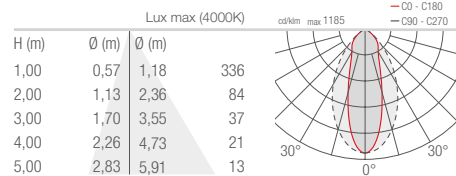

X - 61°x32°

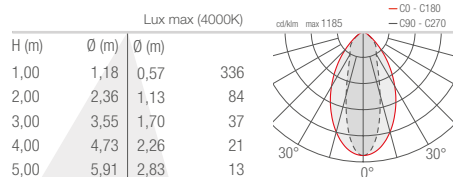

GEKO 5.0

D - Diffuse

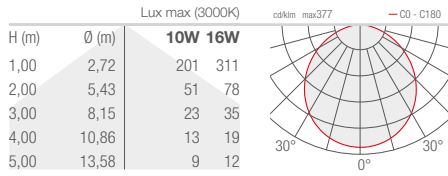

GEKO 5.1

T - 7°

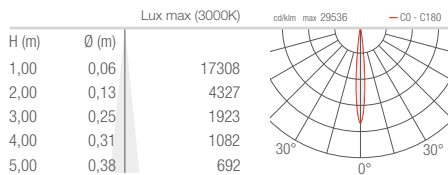

S - 10°

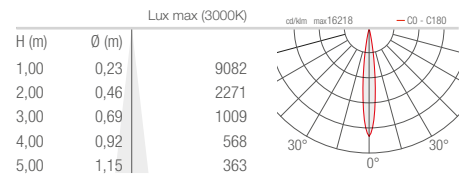

F - 30°

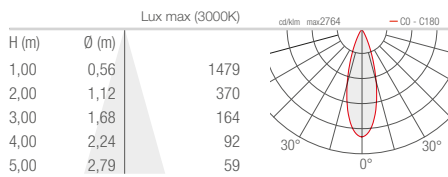

K - 70°

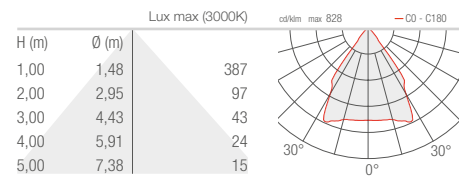

W - 10°x45°

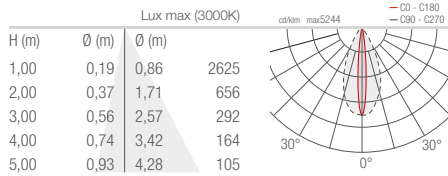

A - Asymmetrical

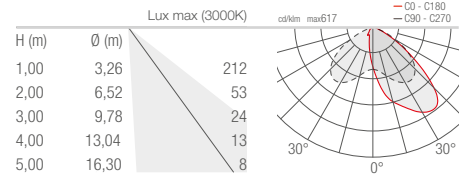



INDOOR PROJECTORS

GEM MINI 1

M - 23°

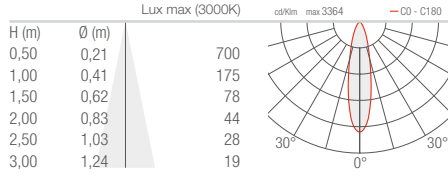

F - 36°

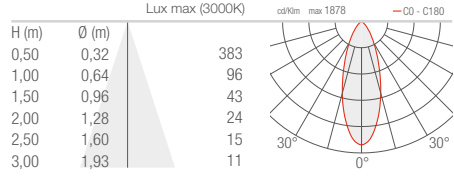

L - 48°

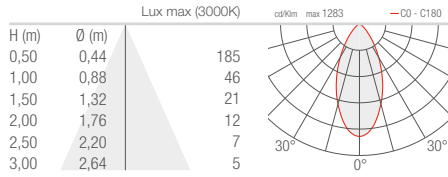

GEM 1.1

S - 17°

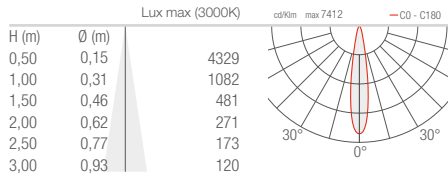

M - 23°

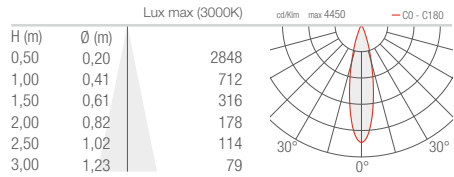

F - 32°

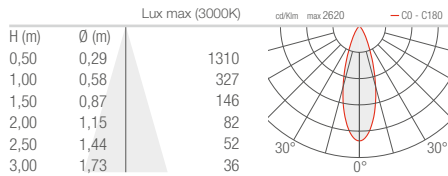

L - 42°

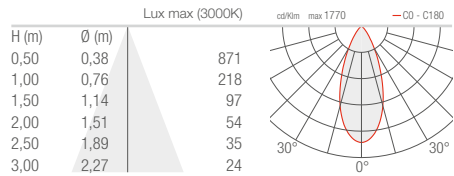

GEM 2.1

S - 16°

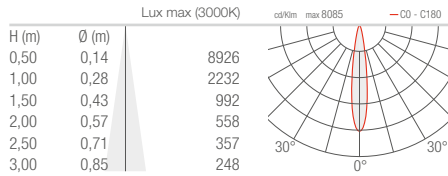

M - 23°

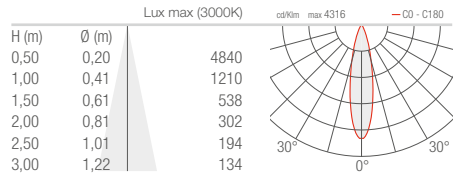

F - 33°

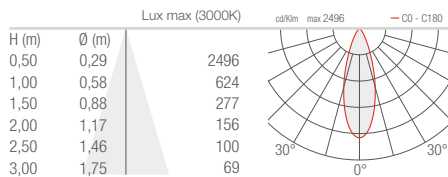

L - 42°

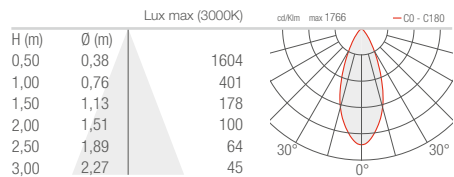

GINKO 1.0

T - 12° CRI 80

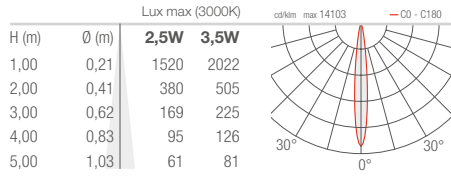

S - 19° CRI 80

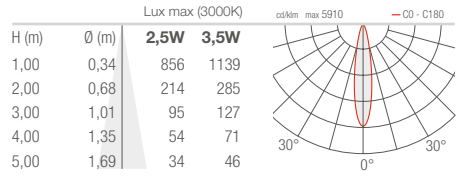

M - 36° CRI 80

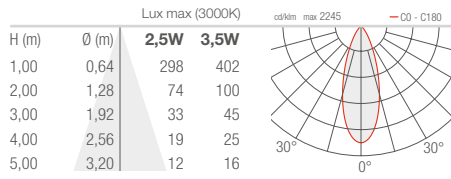

U - 38° sharp CRI 80

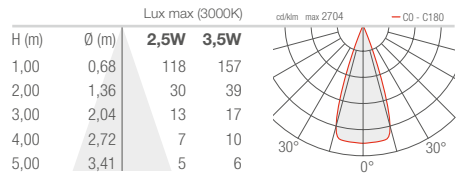

Q - 58° CRI 80

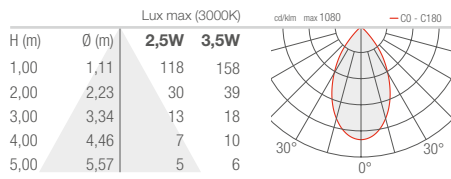

W - 16°x36° CRI 80

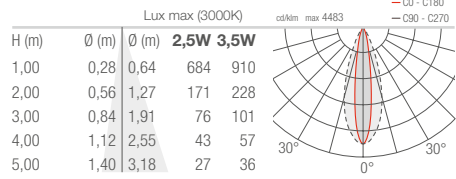

X - 36°x16° CRI 80

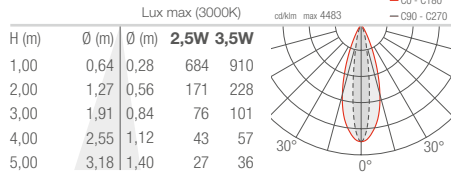

GINKO 1.4

R1 - 8° (8°-28°) CRI 80

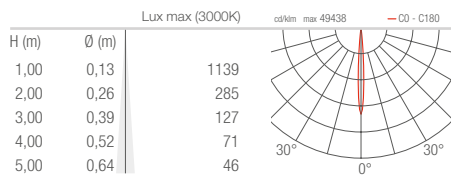

R1 - 28° (8°-28°) CRI 80

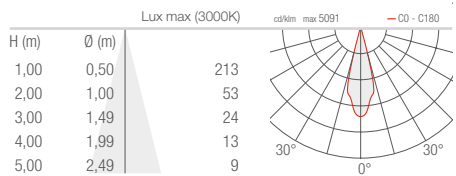

GINKO 2.0

U - 5° CRI 80

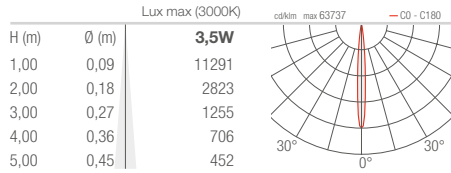

V - 8° CRI 80

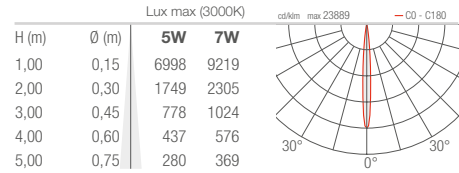

T - 11° CRI 80

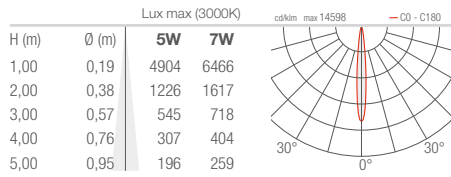

S - 17° CRI 80

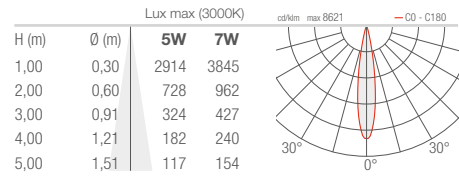

P - 21° sharp CRI 80

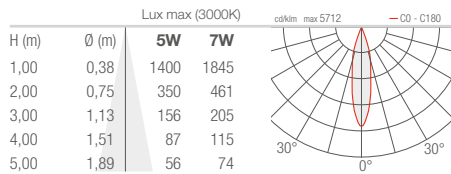

M - 34° CRI 80

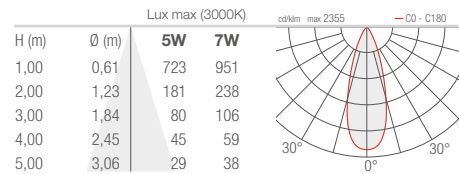

L - 45° CRI 80

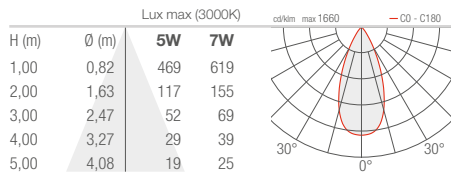

J - 47° CRI 80

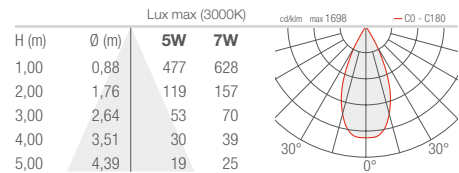

Q - 61° sharp CRI 80

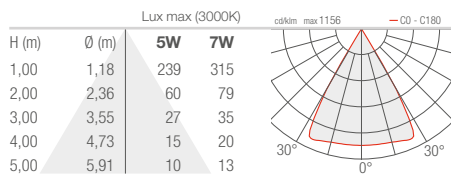

K - 68° CRI 80

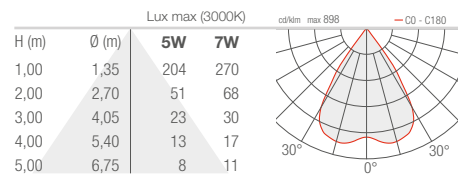

W - 13°x52° CRI 80

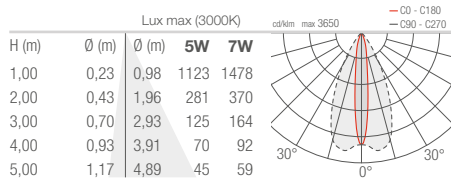

X - 54°x15° CRI 80

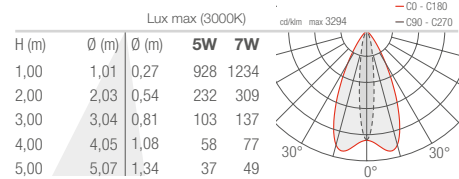

GINKO 2.2

S - 20°

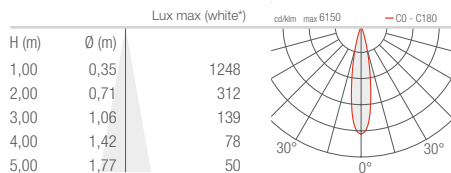

M - 34°

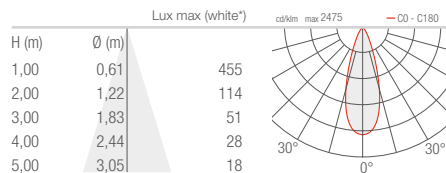

L - 45°

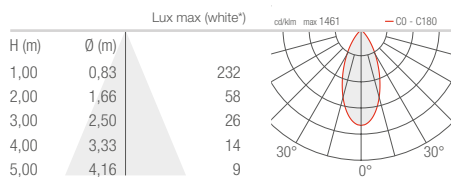

W - 21°x42°

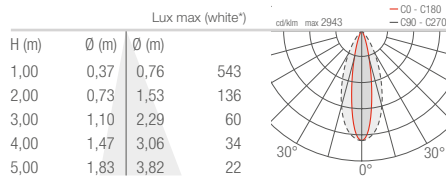

X - 42°x21°

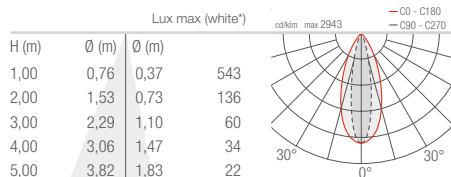

* White created by mixing the colours

GINKO 2.4

R1 - 9° (9°-36°) CRI 80

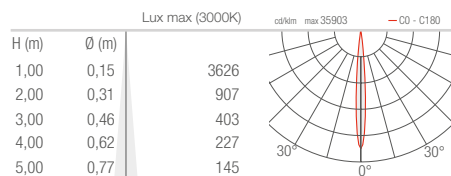

R1 - 36° (9°-36°) CRI 80

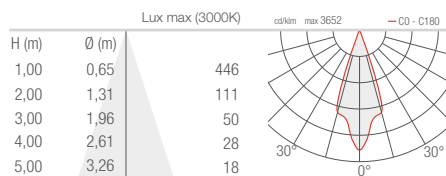

GINKO 3.0

S - 13° CRI 80

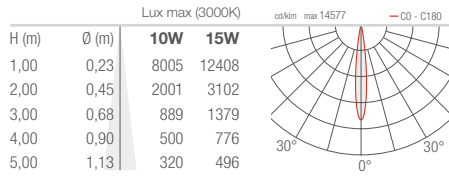

M - 30° CRI 80

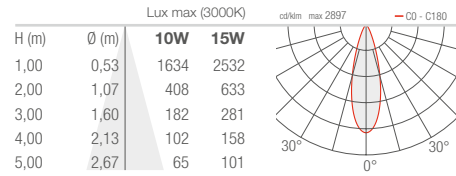

L - 42° CRI 80

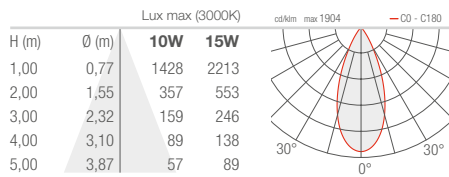

P - 48° sharp CRI 80

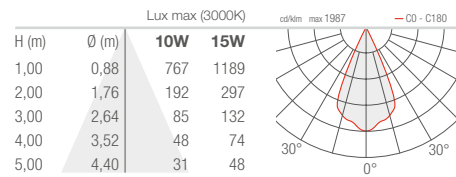

J - 58° CRI 80

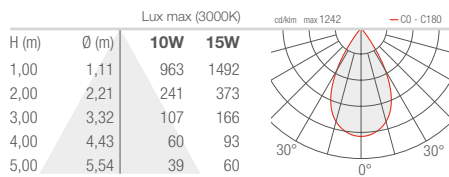

W - 12°x64° adjustable CRI 80

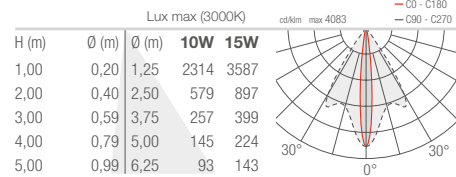

X - 28°x72° adjustable CRI 80

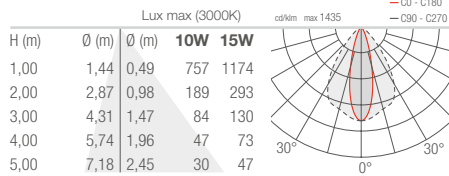

GINKO 3.4

R1 - 8° (8°-38°) CRI 80

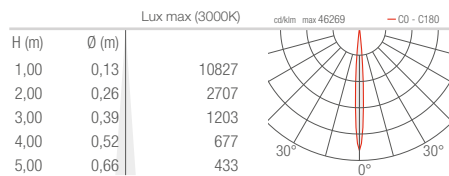

R1 - 38° (8°-38°) CRI 80

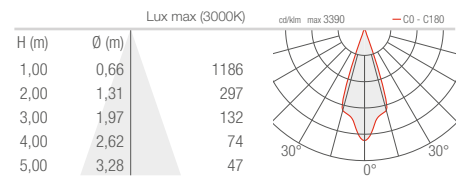

R2 - 8°x66° (8°x66° - 36°x70°) CRI 80

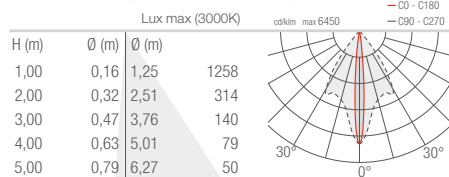

R2 - 36°x70° (8°x66° - 36°x70°) CRI 80

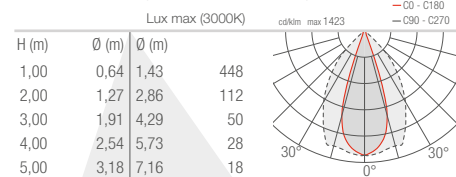

GINKO 4.0

S - 12° CRI 80

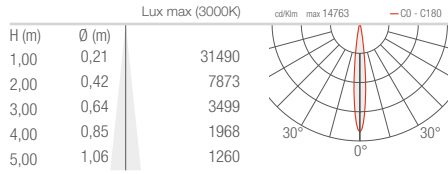

M - 26° CRI 80

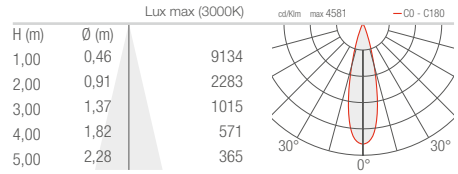

L - 34° CRI 80

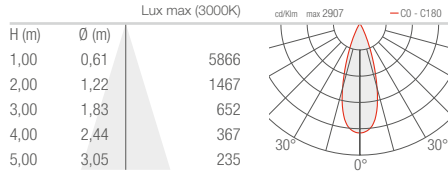

P - 38° sharp CRI 80

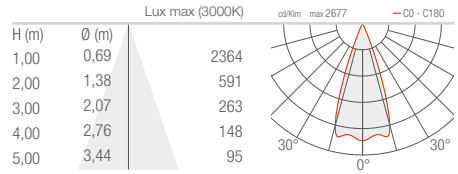

J - 55° CRI 80

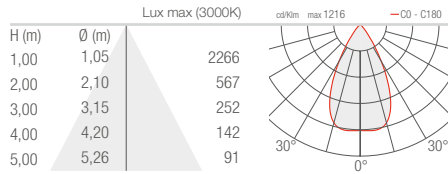

W - 13°x65° adjustable CRI 80

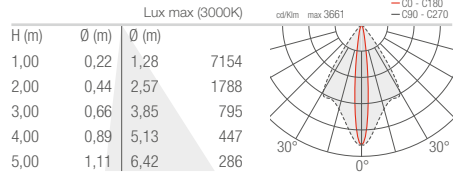

X - 24°x69° adjustable CRI 80

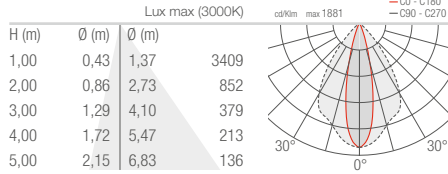

ICE LED

OUTDOOR STEP LIGHTS

ICE LED 1.0 1.1

D - Diffuse

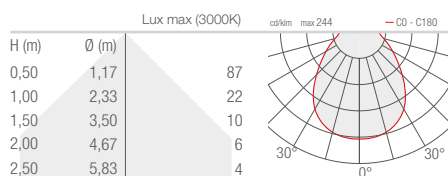



OUTDOOR WALL MOUNTED

INTONO 1.1

S - 13° CRI 80

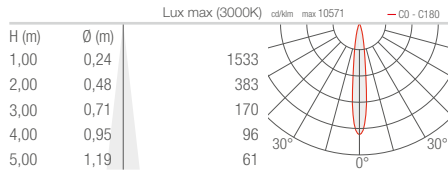

M - 22° CRI 80

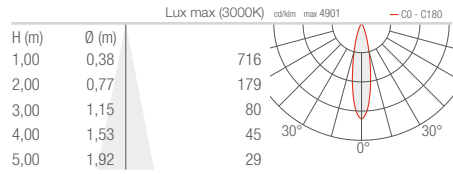

L - 33° CRI 80

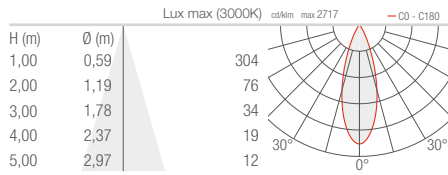

INTONO 2.1

Z - Asymmetrical 8° CRI 80

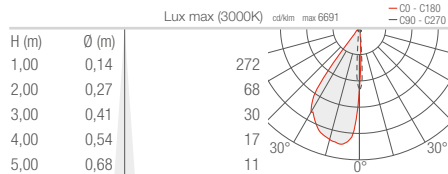

T - 11° CRI 80

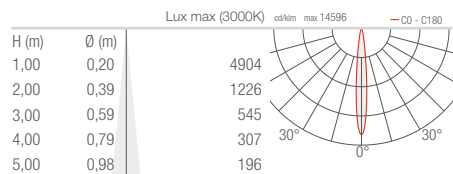

M - 34° CRI 80

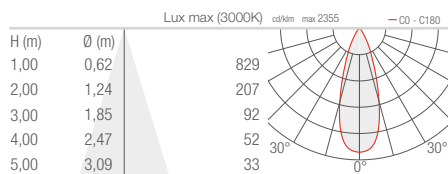

K - 68° CRI 80

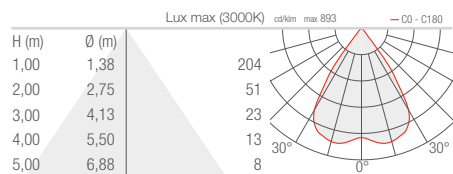

D - Diffuse CRI 80

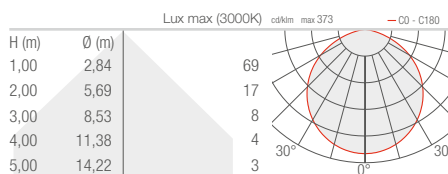

INTONO 3.1

S- 15° CRI 80

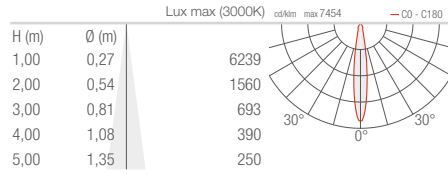

Z- 17° sharp CRI 80

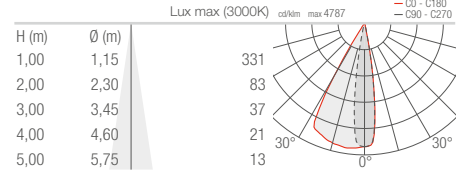

M- 20° CRI 80

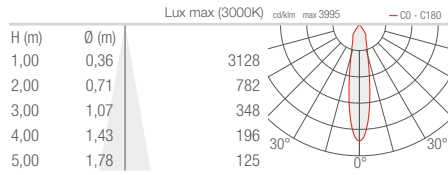

L- 43° CRI 80

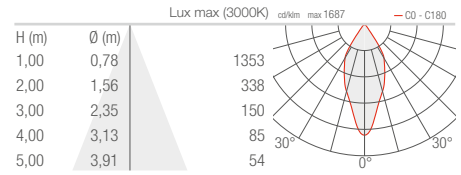

W- Wall grazing CRI 80

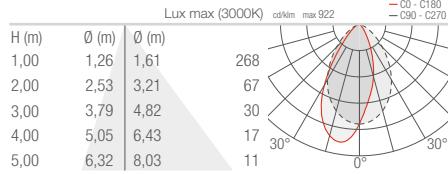

A- Asymmetrical CRI 80

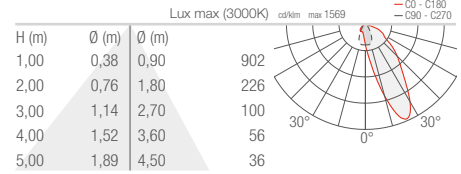

INTONO 4.1

S- 12° CRI 80

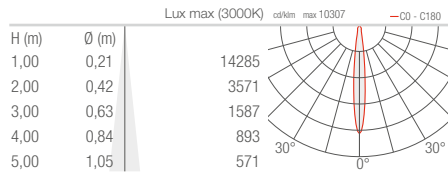

Z- 12° sharp CRI 80

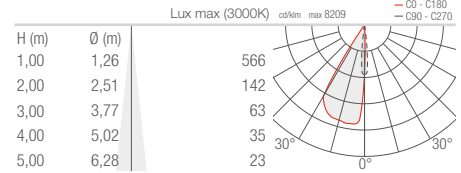

M- 23° CRI 80

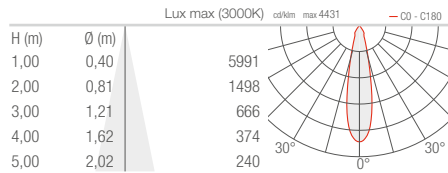

L- 57° CRI 80

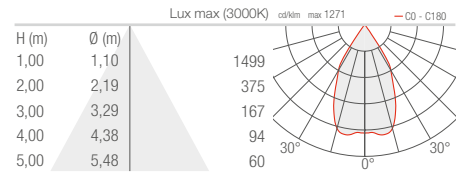

W- Wall grazing CRI 80

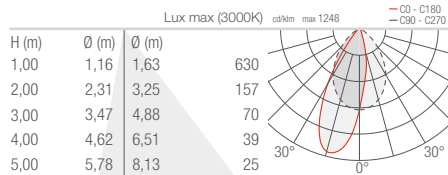

A- Asymmetrical CRI 80

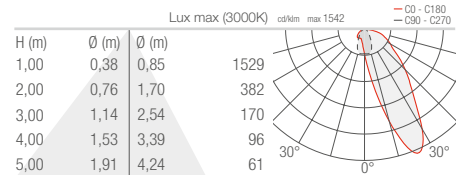

INTONO C IN / INTONO C OUT

INDOOR CEILING MOUNTED / OUTDOOR CEILING MOUNTED

INTONO C IN 2.3 INTONO C OUT 2.4

TT - 11° CRI 80

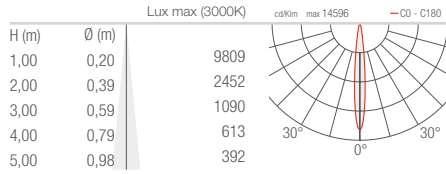

MM - 34° CRI 80

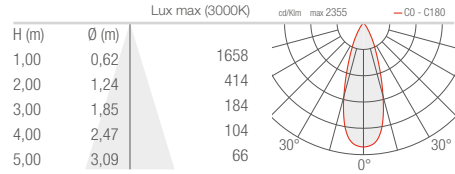

KK - 68° CRI 80

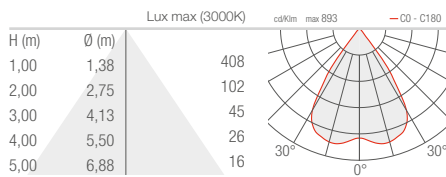

DD - Diffuse CRI 80

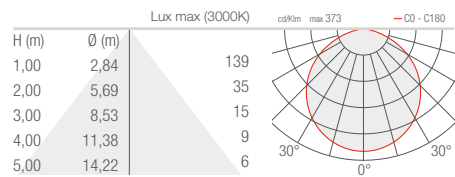

INTONO C IN 3.3 INTONO C OUT 3.4

SS - 15° CRI 80

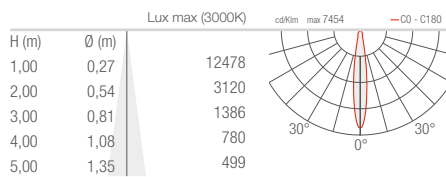

MM - 20° CRI 80

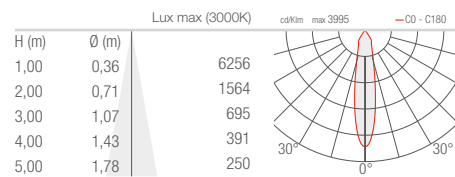

LL - 43° CRI 80

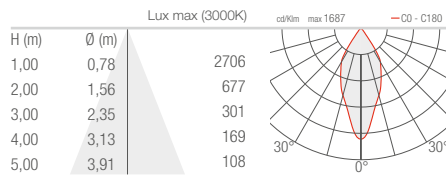

AA - Asymmetrical CRI 80

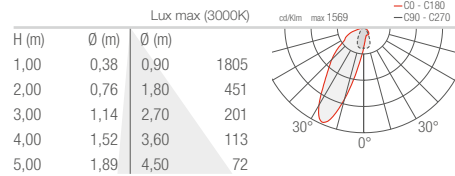

INTONO C IN 3.8 INTONO C OUT 3.9

M - 20° CRI 80

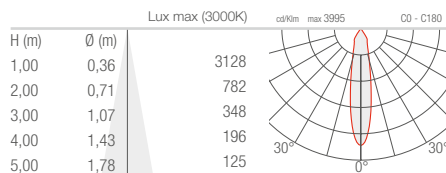

KOCCA 1.1 4W

W - Asymmetrical 10°

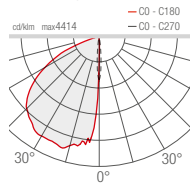

K - Asymmetrical 70°

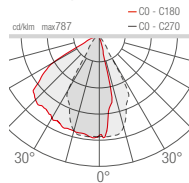

A - Asymmetrical 140°

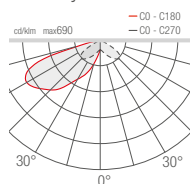

KOCCA 1.1 8.5W

W - Asymmetrical 10°

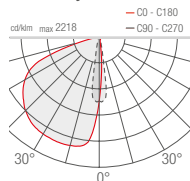

A - Asymmetrical 140°

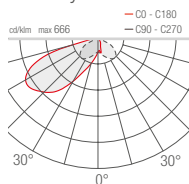

D - Diffuse

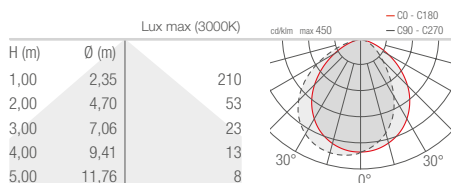

KOCCA 3.1

T - 7°

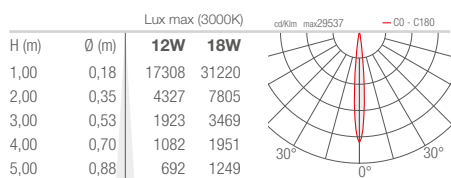

S - 10°

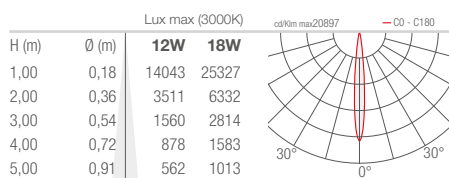

F - 30°

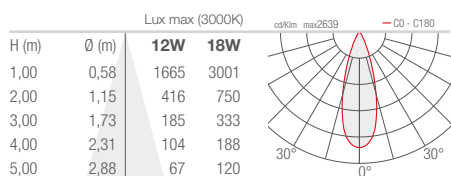

D - Diffuse

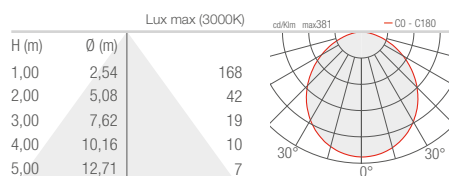

INDOOR SUSPENDED

KORA 1.0

S - 18°

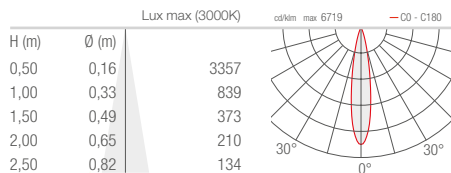

M - 35°

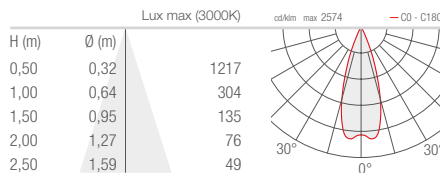

KORA 2.0

S - 17°

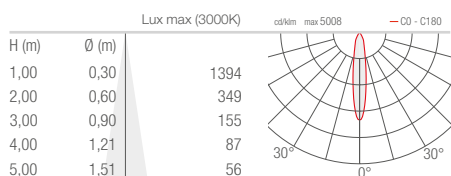

M - 24°

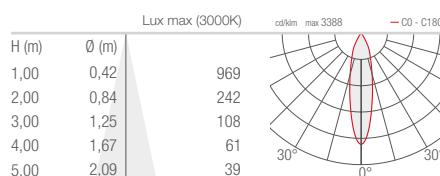

L - 58°

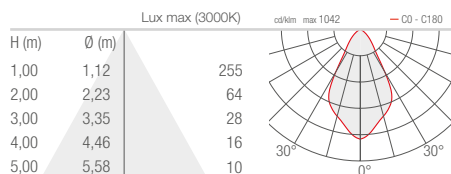

KORA 3.0

S - 23°

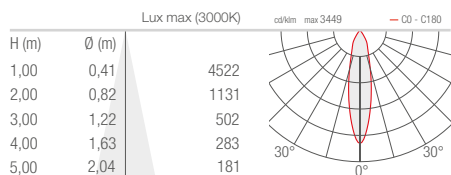

M - 38°

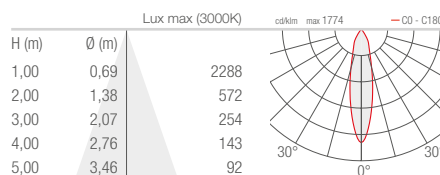

L - 65°

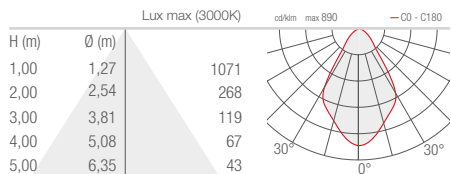

KRILL 1.0

M - 23°

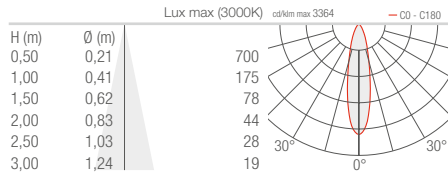

L - 36°

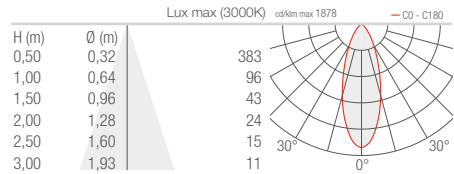

J - 48°

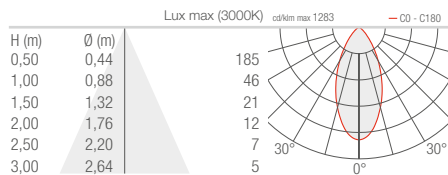

W - 26°x40°

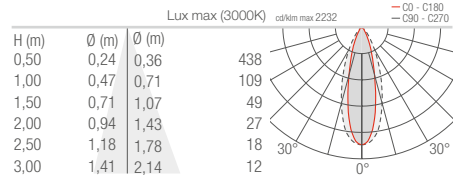

X - 40°x26°

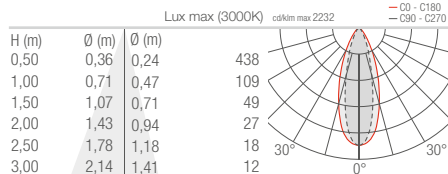

KRILL 1.4

R1 - 22° (22°-64°)

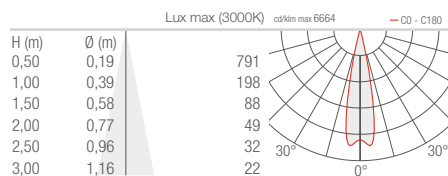

R1 - 64° (22°-64°)

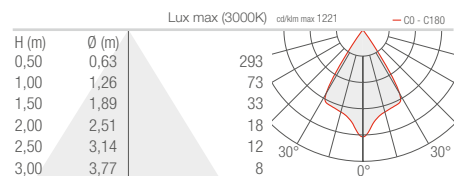

KRILL 2.0

S - 17°

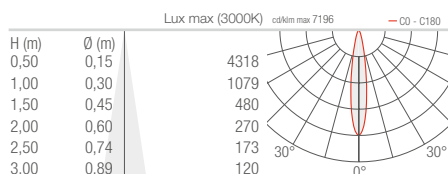

M - 25°

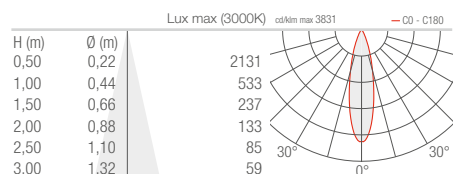

L - 33°

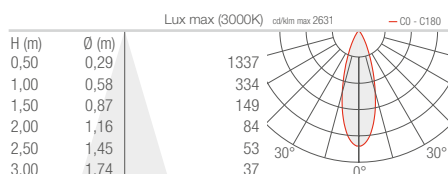

W - 23°x50°

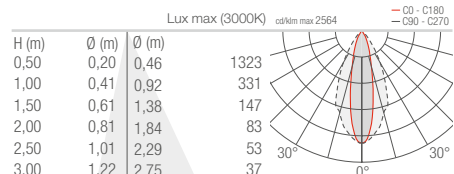

KRILL 2.0

X - 50°x23°

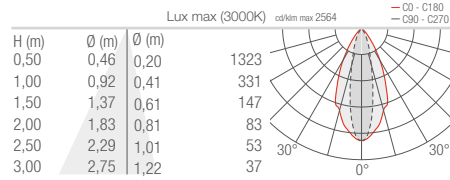

KRILL 2.4

R1 - 9° (9°-70°)

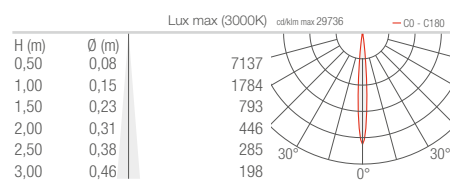

R1 - 70° (9°-70°)

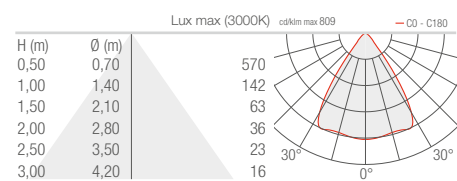

KRILL 3.0

S - 16°

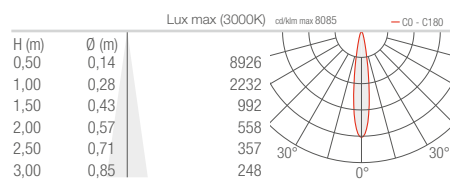

M - 23°

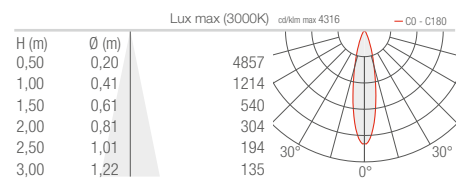

L - 33°

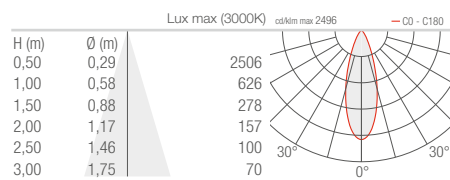

K - 42°

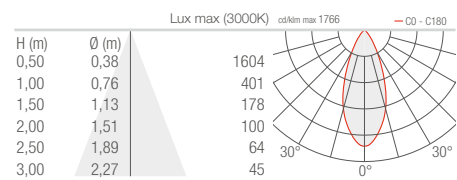

W - 21°x50°

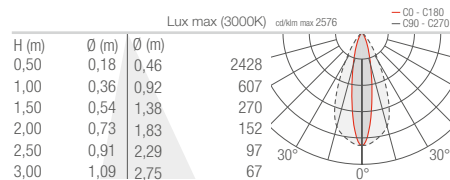

X - 50°x21°

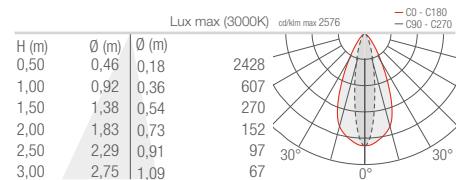

KRILL 3.4

R1 - 18° (18°-80°)

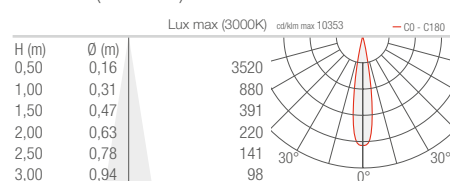

R1 - 80° (18°-80°)

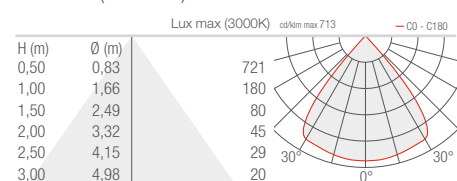

LINE 1.0 1.1

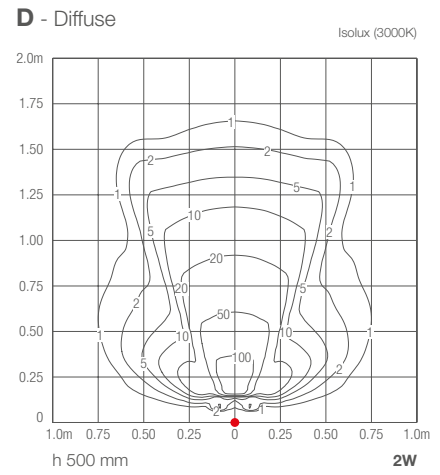
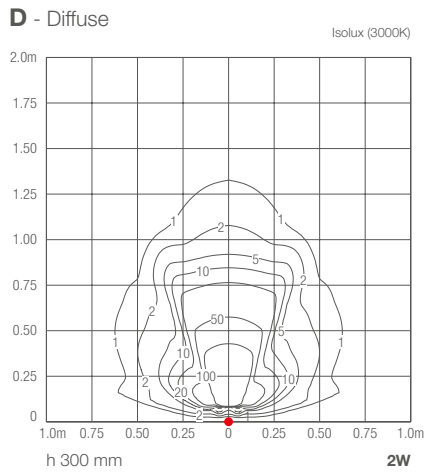

LINE 2.0 2.1

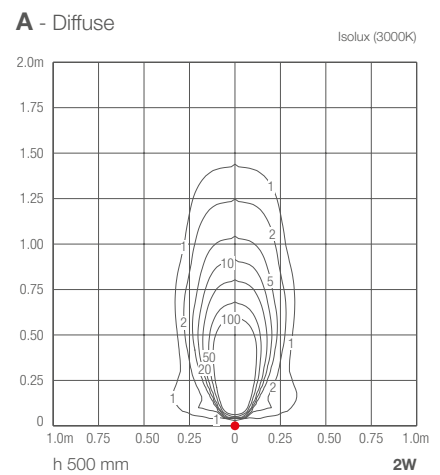
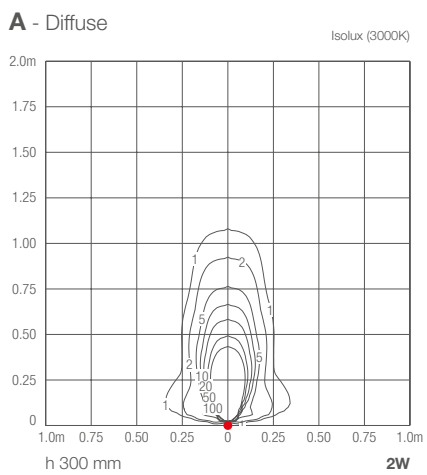

OUTDOOR BOLLARDS

LINEAR 2.1

A - Asymmetrical

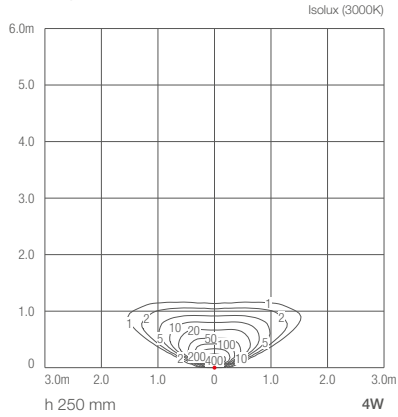

A - Asymmetrical

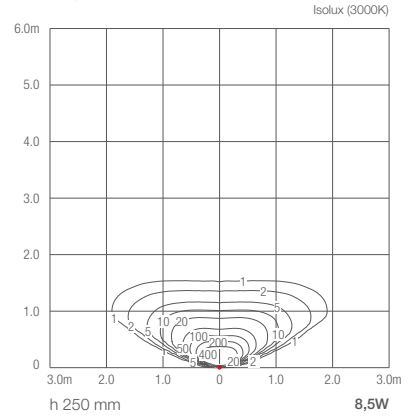

A - Asymmetrical

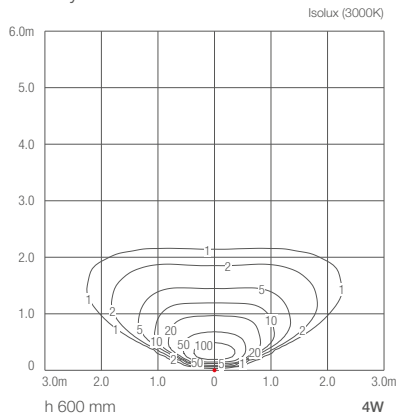

A - Asymmetrical

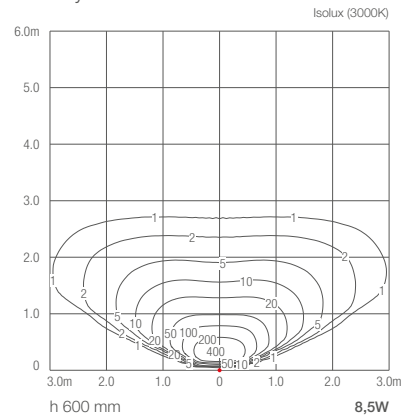

A - Asymmetrical

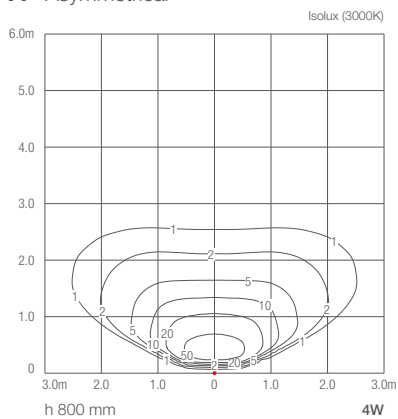

A - Asymmetrical

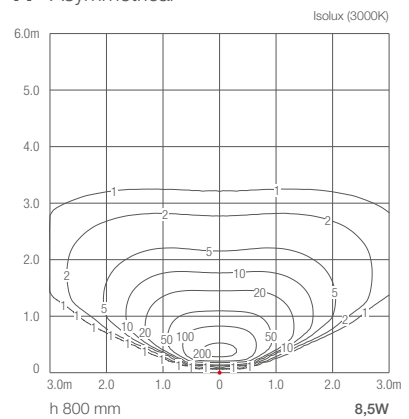

LINEAR 4.1

A - Asymmetrical

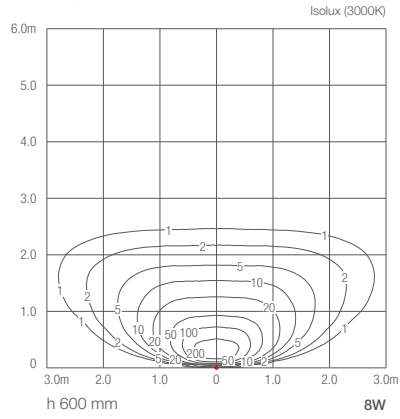

A - Asymmetrical

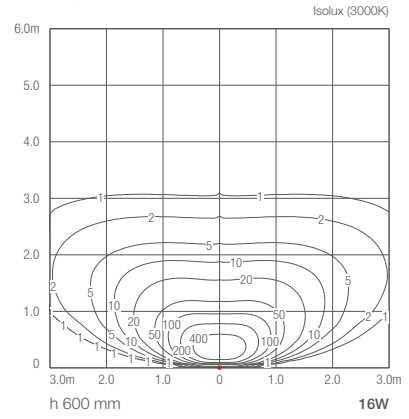

A - Asymmetrical

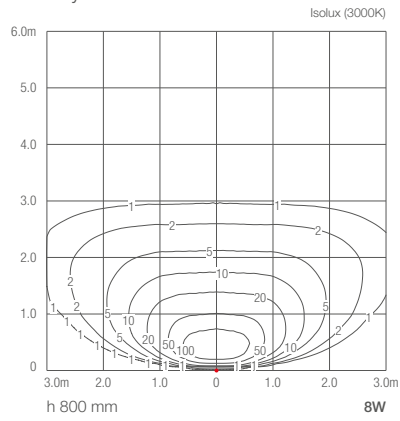

A - Asymmetrical

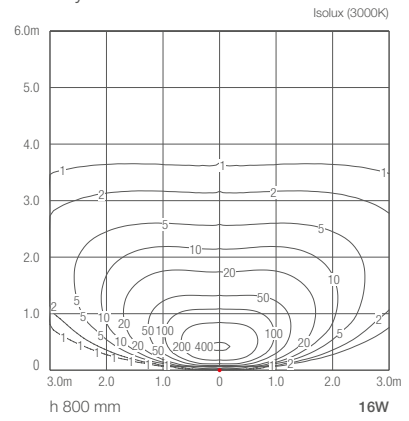

OUTDOOR STEP LIGHTS

LIRA 1.0

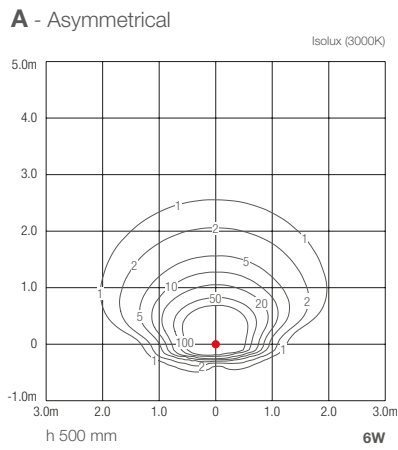

LIRA 2.0

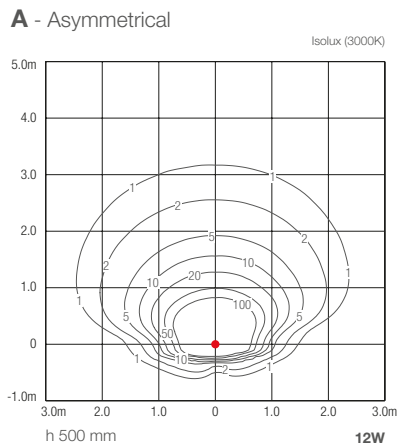

LITUS 1.0 1.1

S - 13° CRI 80

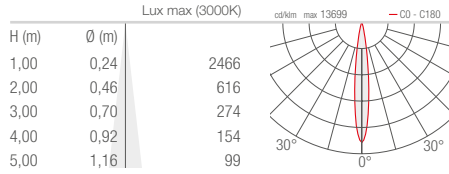

M - 22° CRI 80

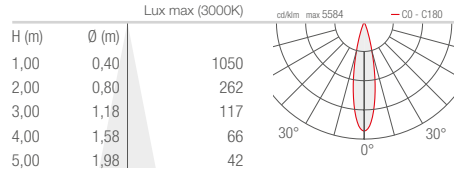

F - 30° CRI 80

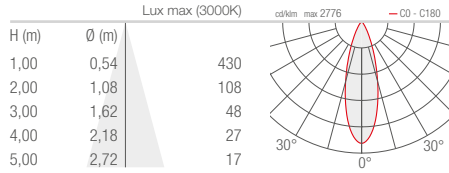

P - 35° sharp CRI 80

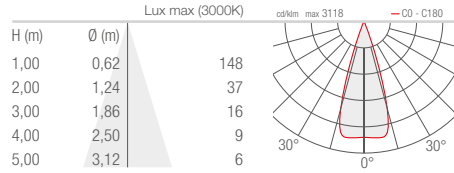

L - 48° CRI 80

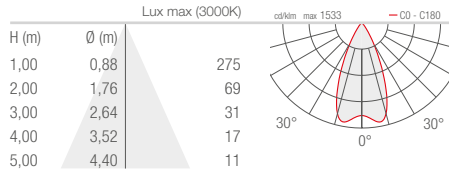

D - Diffuse CRI 80

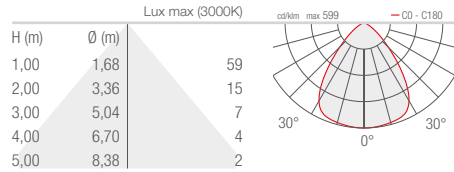

LITUS 1.6 1.7 2.8 2.9

S - 13° CRI 80

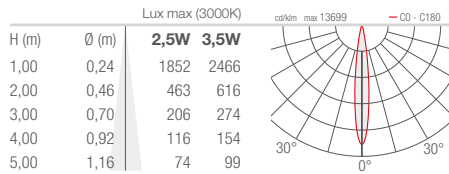

M - 22° CRI 80

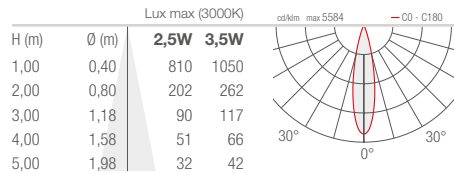

F - 30° CRI 80

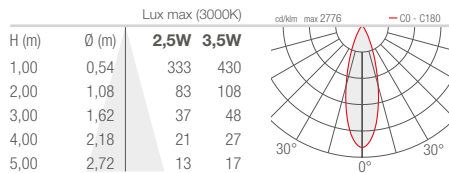

P - 35° sharp CRI 80

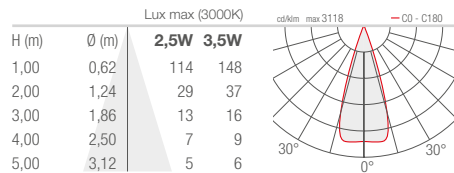

L - 48° CRI 80

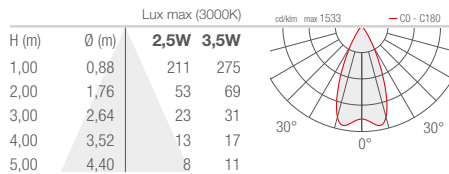

D - Diffuse CRI 80 (Litus 1.6 / 1.7)

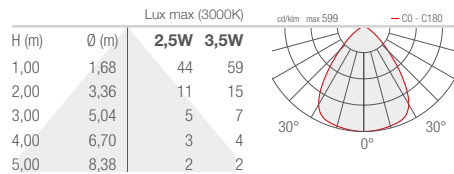

LITUS 2.4
2.5
5.6
5.7

U - 5° CRI 80

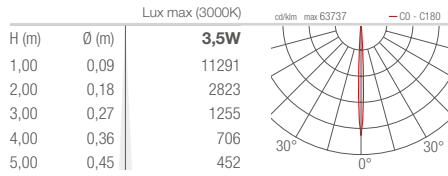

V - 8° CRI 80

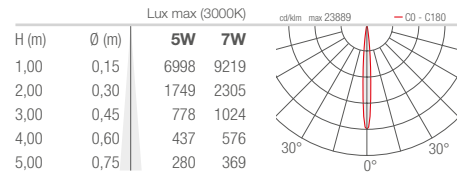

T - 11° CRI 80

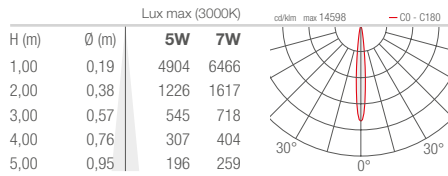

S - 17° CRI 80

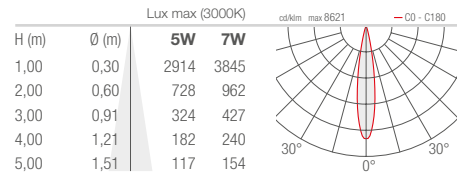

P - 21° sharp CRI 80

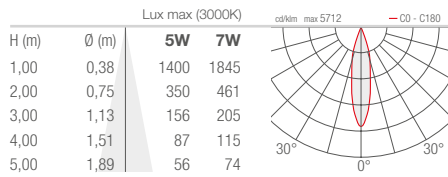

M - 34° CRI 80

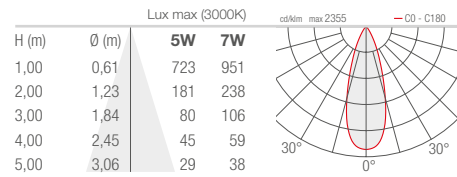

L - 45° CRI 80

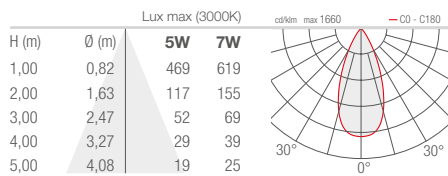

Q - 61° sharp CRI 80

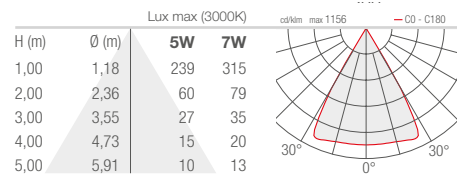

W - 13°x52° CRI 80

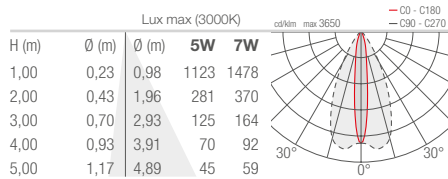

D - Diffuse CRI 80 (Litus 2.4 / 2.5)

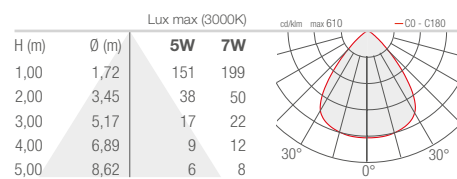

LITUS 5.4 5.5

S - 16° CRI 80

		Lux max (3000K)		cd/klm max 8942	- C0 - C180
H (m)	Ø (m)	10W	13W		
1,00	0,28	5580	7431		
2,00	0,56	1395	1858		
3,00	0,84	620	826		
4,00	1,13	349	464		
5,00	1,41	223	297		

M - 21° CRI 80

		Lux max (3000K)		cd/klm max 5372	- C0 - C180
H (m)	Ø (m)	10W	13W		
1,00	0,37	3304	4405		
2,00	0,74	826	1101		
3,00	1,11	367	489		
4,00	1,49	206	275		
5,00	1,86	132	176		

L - 38° CRI 80

		Lux max (3000K)		cd/klm max 2188	- C0 - C180
H (m)	Ø (m)	10W	13W		
1,00	0,69	1755	2330		
2,00	1,38	439	582		
3,00	2,07	195	259		
4,00	2,76	110	146		
5,00	3,45	70	93		

P - 58° sharp CRI 80

		Lux max (3000K)		cd/klm max 1281	- C0 - C180
H (m)	Ø (m)	10W	13W		
1,00	1,12	513	681		
2,00	2,25	128	170		
3,00	3,37	57	76		
4,00	4,50	32	43		
5,00	5,62	21	27		

K - 55° CRI 80

		Lux max (3000K)		cd/klm max 1267	- C0 - C180
H (m)	Ø (m)	10W	13W		
1,00	1,04	1070	1425		
2,00	2,08	268	356		
3,00	3,12	119	158		
4,00	4,16	67	89		
5,00	5,20	43	57		

W - 16°x69° adjustable CRI 80

		Lux max (3000K)		cd/klm max 2687	- C0 - C180 - C90 - C270
H (m)	Ø (m)	10W	13W		
1,00	0,28	1,37	1537	2048	
2,00	0,56	2,74	384	512	
3,00	0,84	4,11	171	222	
4,00	1,12	5,48	96	128	
5,00	1,40	6,85	61	82	

D - Diffuse CRI 80

		Lux max (3000K)		cd/klm max 620	- C0 - C180
H (m)	Ø (m)	10W	13W		
1,00	1,70	372	495		
2,00	3,39	93	124		
3,00	5,09	41	55		
4,00	6,79	23	31		
5,00	8,48	15	20		



OUTDOOR PROJECTORS

LYSS MINI 1.0

Z - Clear 8°x160°

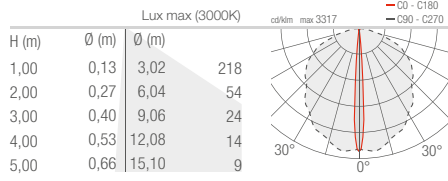

Y - Satin 9°x160°

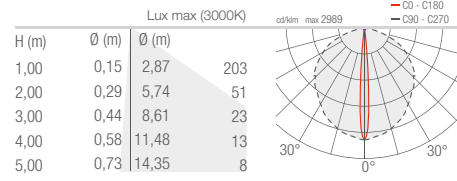

LYSS 1.0

Z - Clear 10°x180°

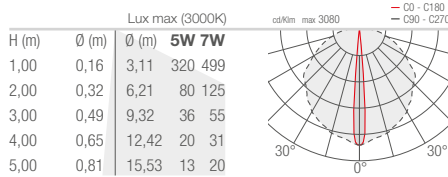

Y - Satin 20°x180°

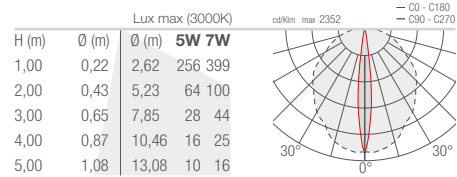

LYSS 2.0

U - 12°x160°

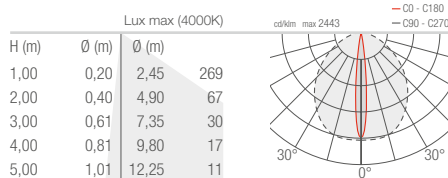

MOBY / MOBY P

UNDERWATER RECESSED / UNDERWATER PROJECTORS

MOBY 1.0
1.1
MOBY P 1.0
1.1

S - 22°

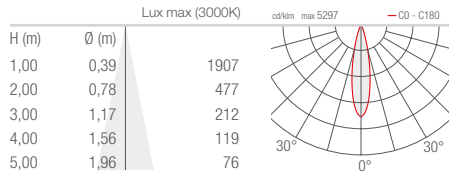

M - 34°

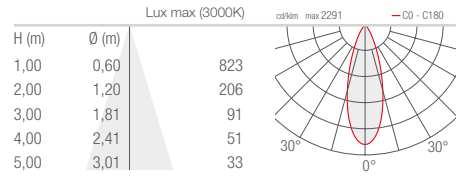

L - 62°

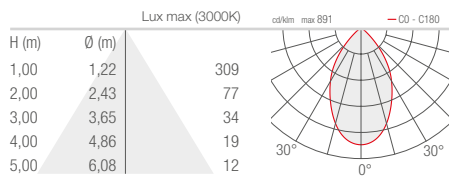

W - 31°x64°

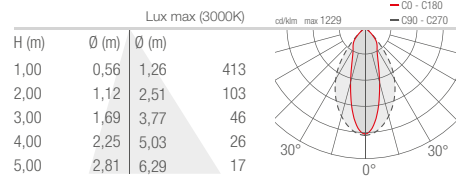

MOBY 2.0
2.1
MOBY P 2.0
2.1

S - 22°

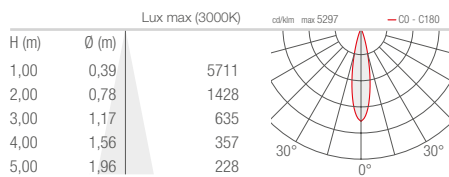

M - 34°

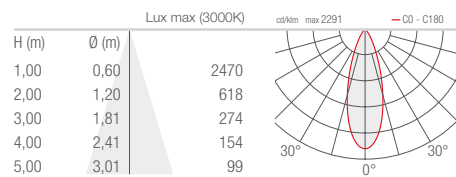

L - 62°

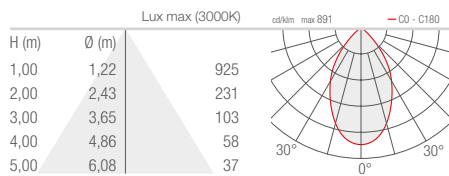

W - 31°x64°

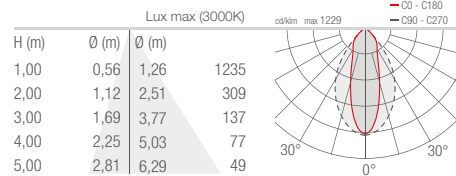

MOBY 3.0
3.1
MOBY P 3.0
3.1

S - 22°

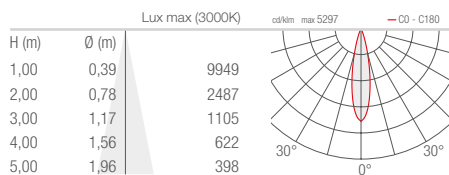

M - 34°

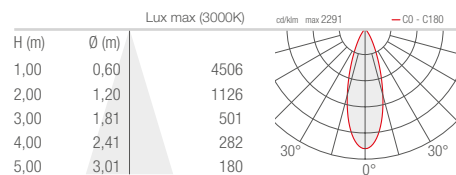

L - 62°

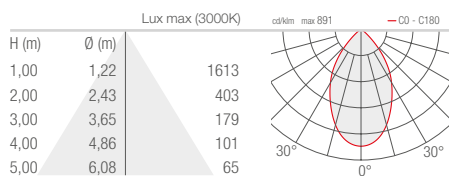

W - 31°x64°

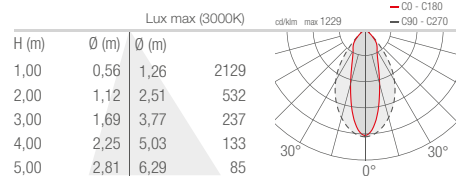



OUTDOOR LINEAR PROFILES

NEVA MINI 1

S - 11°

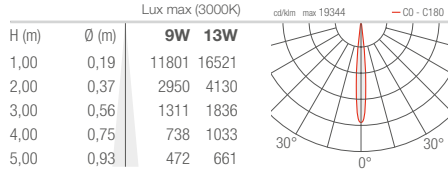

M - 30°

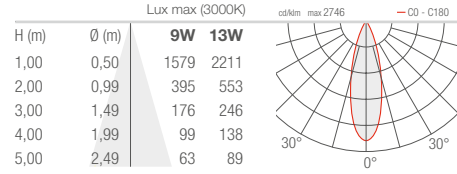

L - 45°

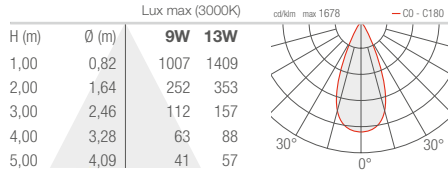

W - 10°x40°

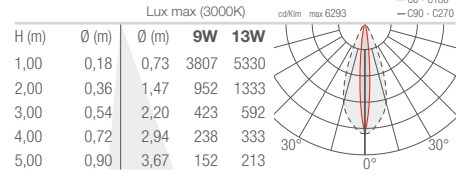

NEVA MINI 2

S - 11°

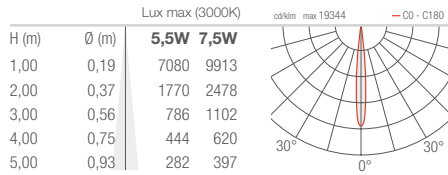

M - 30°

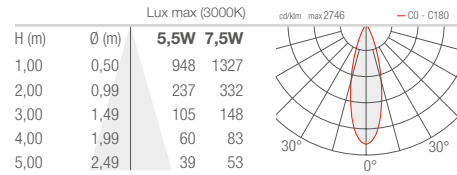

L - 45°

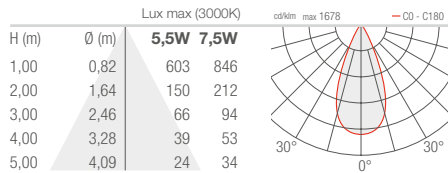

W - 10°x40°

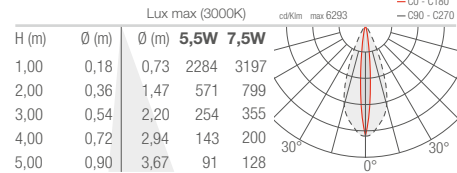

NEVA MINI 5

S - 15°

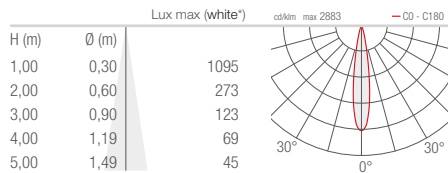

M - 26°

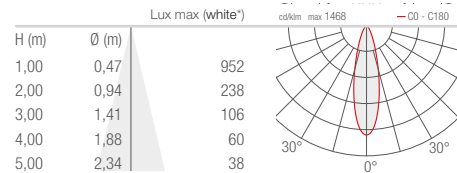

L - 30°

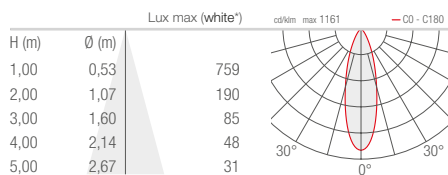

W - 24°x46°

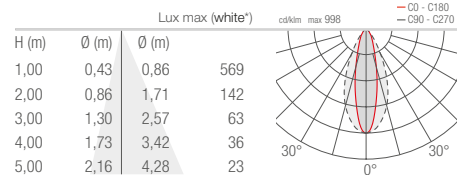

* White created by mixing the colours

NEVA MINI 6

S - 15°

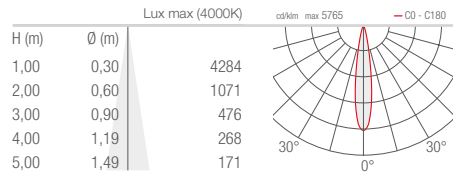

M - 26°

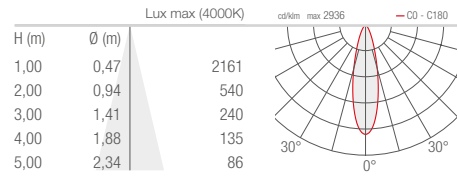

L - 30°

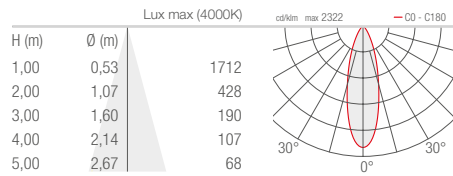

W - 24°x46°

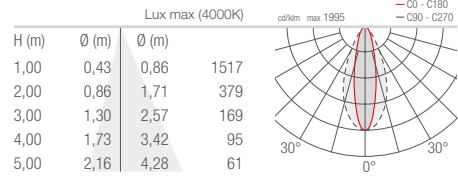

NEVA MINI 7

S - 18°

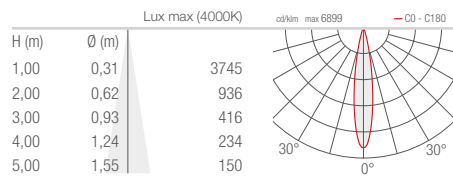

M - 32°

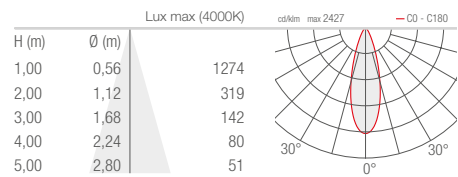

L - 44°

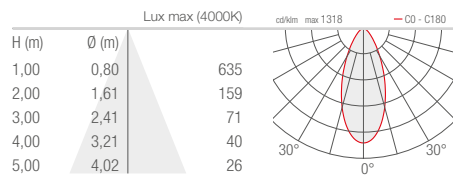

K - 78°

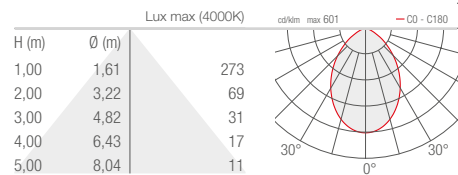

W - 26°x58°

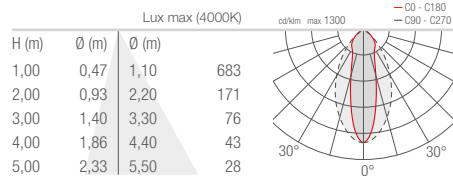

NEVA 1.0

S - 11°

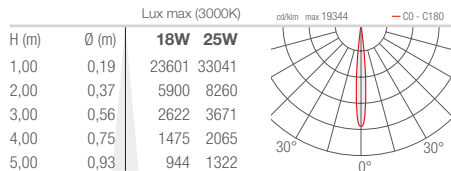

M - 30°

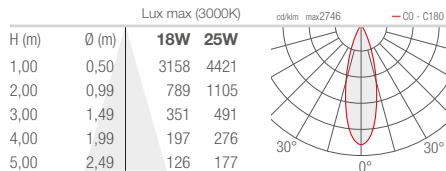

L - 45°

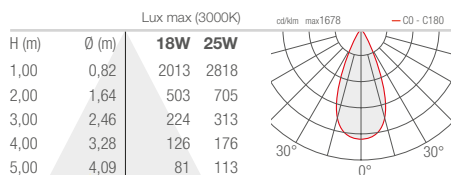

W - 10°x40°

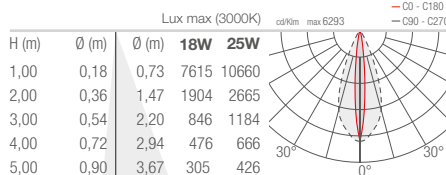

NEVA 2.0

S - 11°

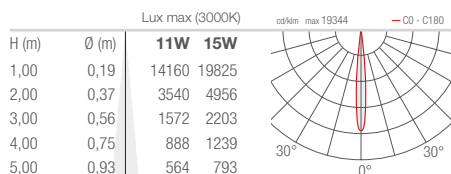

M - 30°

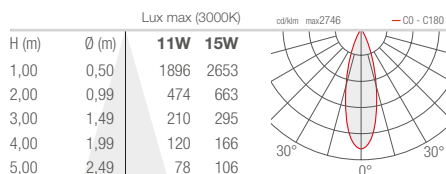

L - 45°

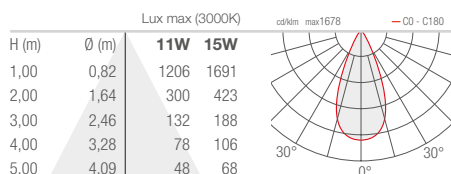

W - 10°x40°

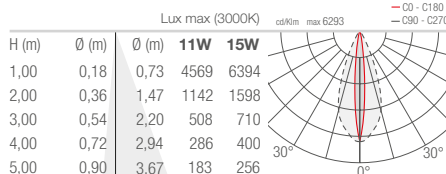

NEVA 3.0

S - 11°

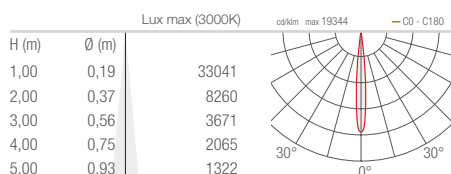

M - 30°

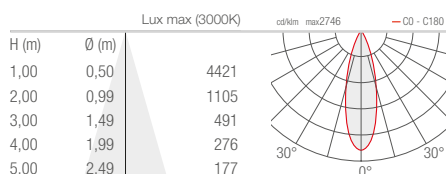

L - 45°

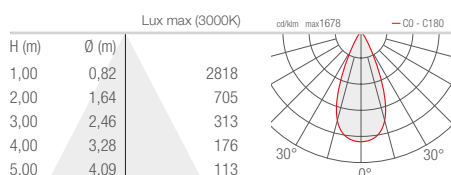

W - 10°x40°

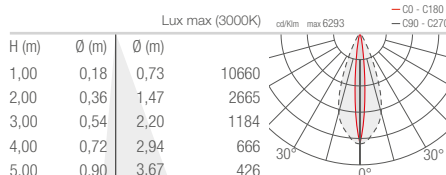

NEVA 4.0

S - 11°

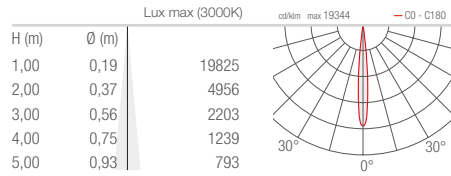

M - 30°

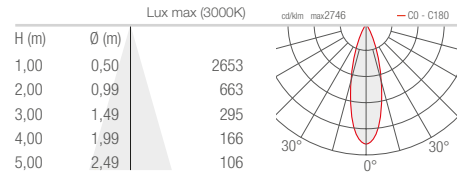

L - 45°

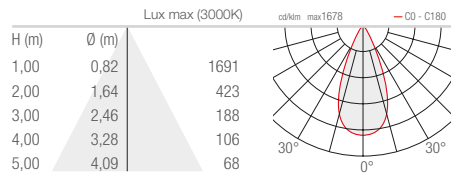

W - 10°x40°

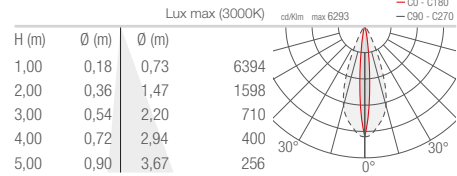

NEVA 5.0

S - 15°

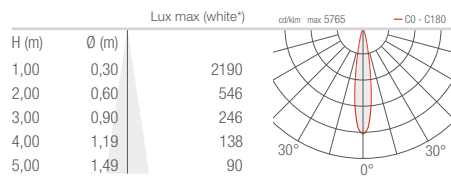

M - 26°

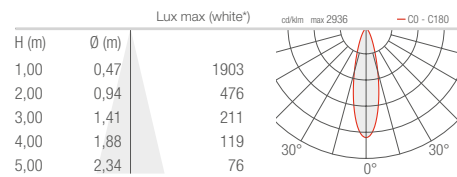

L - 30°

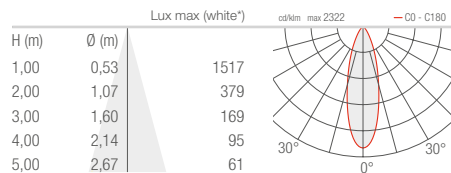

W - 24°x46°

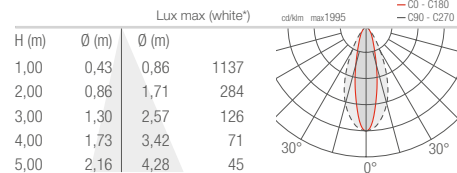

* White created by mixing the colours

NEVA 6.0

S - 15°

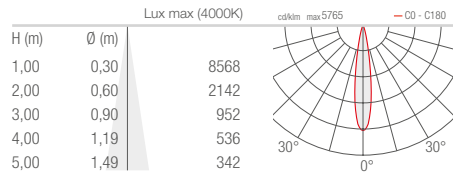

M - 26°

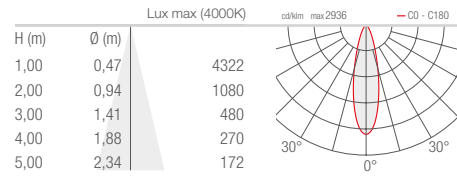

L - 30°

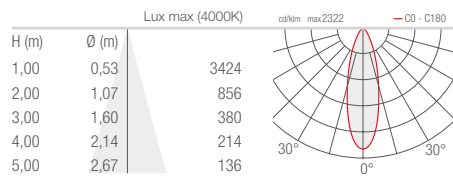

W - 24°x46°

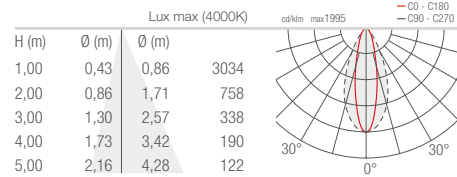

NEVA 7.0

S - 18°

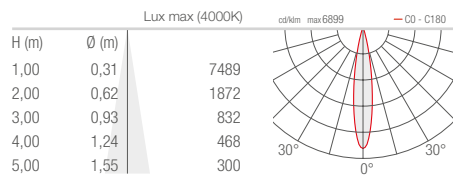

M - 32°

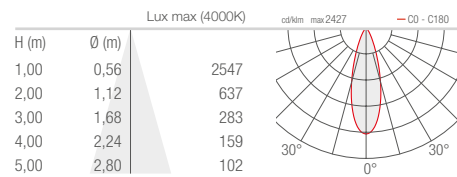

L - 44°

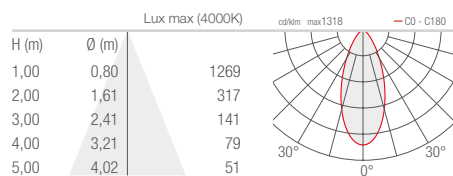

K - 78°

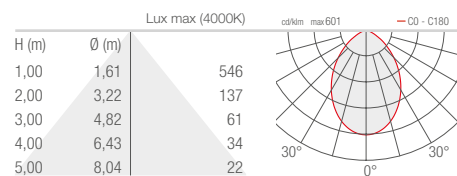

W - 26°x58°

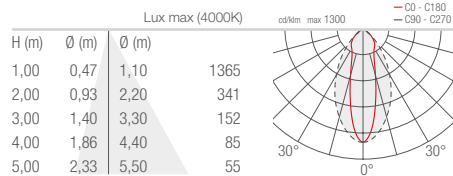

PASITO

OUTDOOR STEP LIGHTS

PASITO MINI 1.0

1.1
1.2

A - Asymmetrical 150°x90° CRI 80

Isolux (3000K)

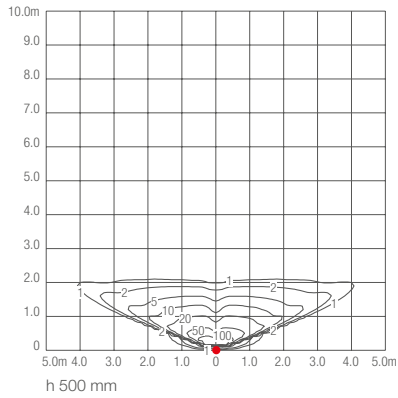

B - 60° CRI 80

Isolux (3000K)

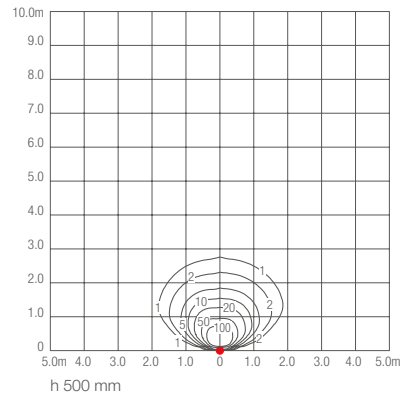

A - Asymmetrical 150°x90° CRI 80

Isolux (3000K)

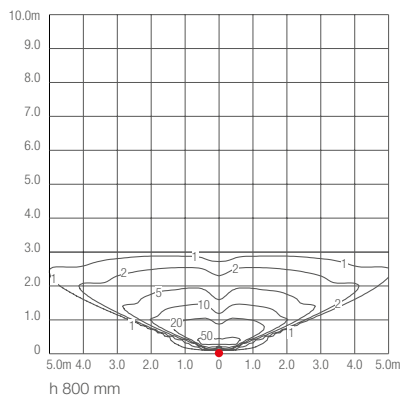

B - 60° CRI 80

Isolux (3000K)

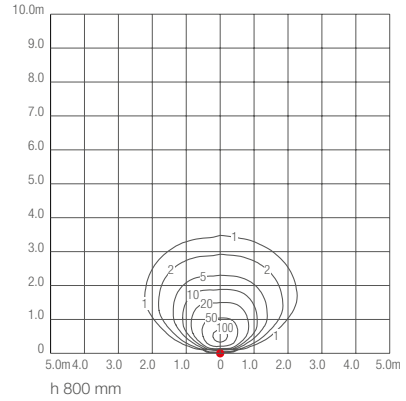

PASITO 1.0

A - Asymmetrical 150°x90° CRI 80

Isolux (3000K)

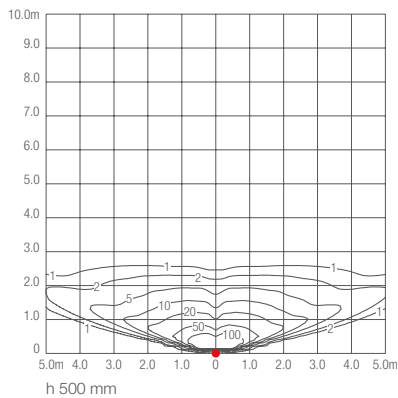

B - 60° CRI 80

Isolux (3000K)

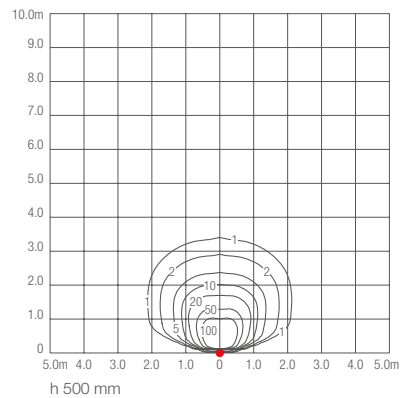

PASITO 1.0

A - Asymmetrical 150°x90° CRI 80

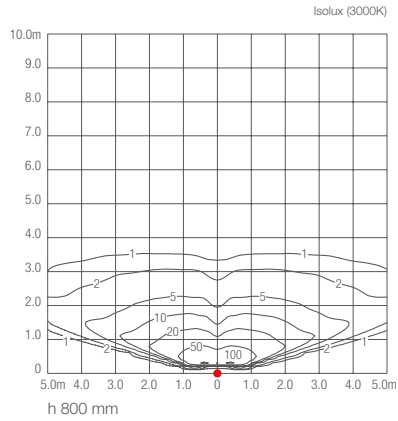

B - 60° CRI 80

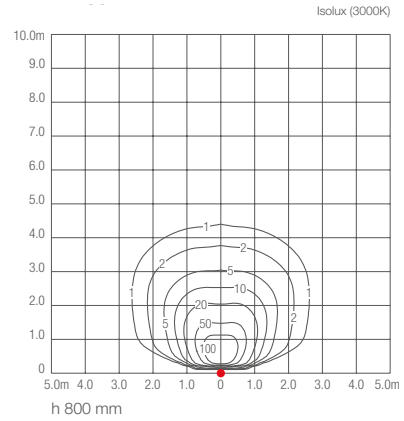

**PASITO 1.1
1.2**

A - Asymmetrical 150°x90° CRI 80

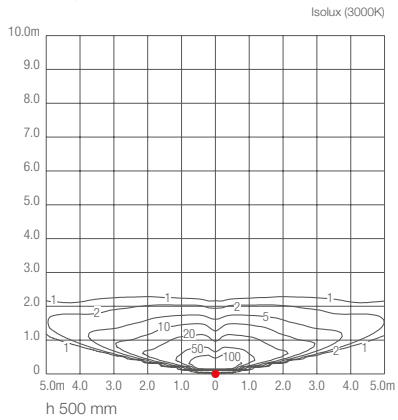

B - 60° CRI 80

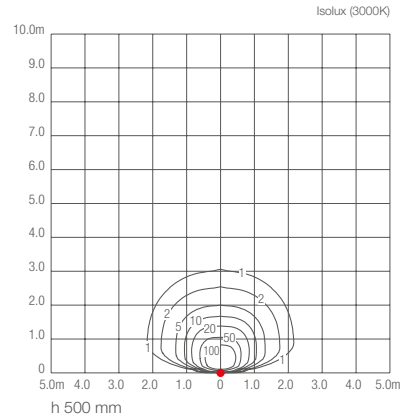

A - Asymmetrical 150°x90° CRI 80

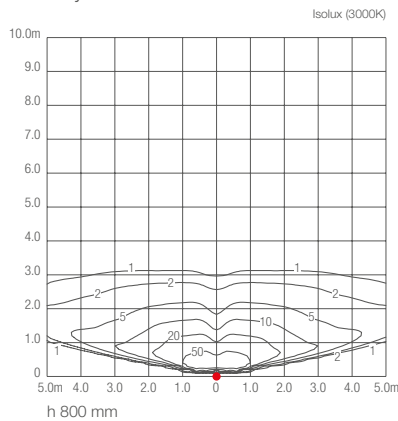

B - 60° CRI 80

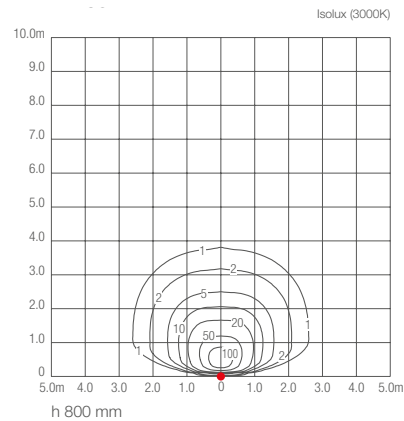

PIVOT MINI 1

S - 15° CRI 80

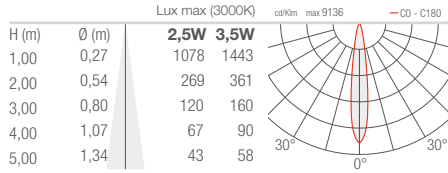

M - 21° CRI 80

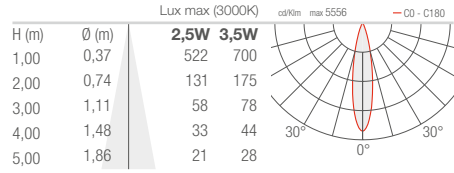

P - 30° sharp CRI 80

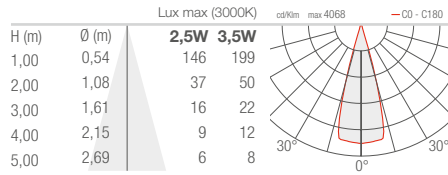

L - 35° CRI 80

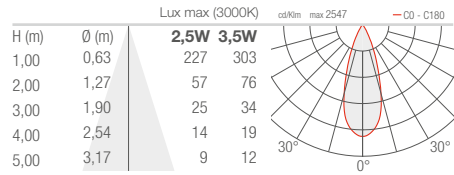

PIVOT 1.7

U - 5° CRI 80

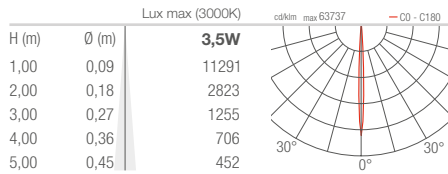

V - 8° CRI 80

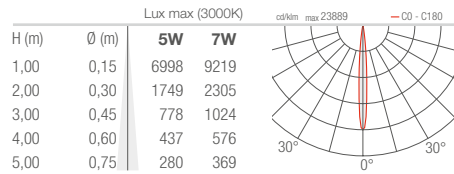

T - 11° CRI 80

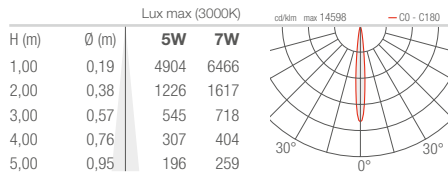

S - 17° CRI 80

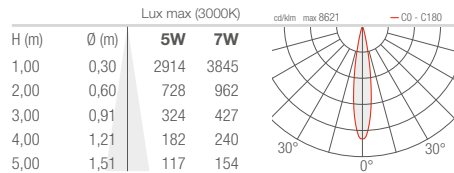

P - 21° sharp CRI 80

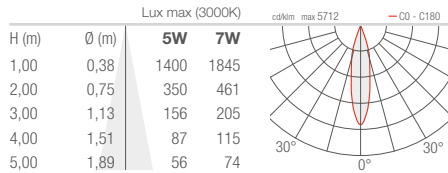

M - 34° CRI 80

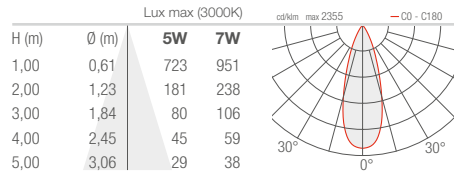

L - 43° CRI 80

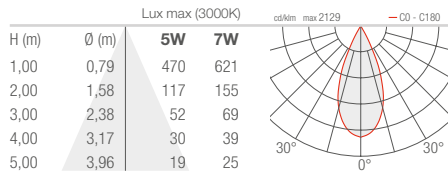

J - 45° CRI 80

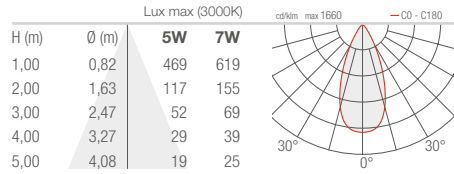

PIVOT 1.7

Q - 51° sharp CRI 80

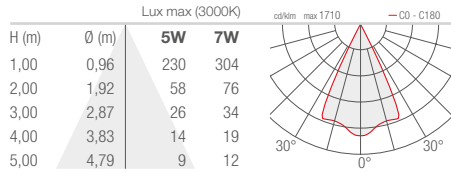

K - 54° CRI 80

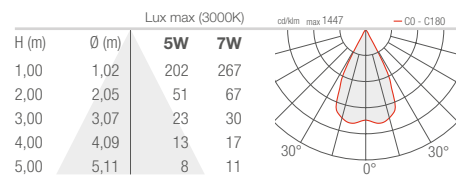

W - 15°x47° CRI 80

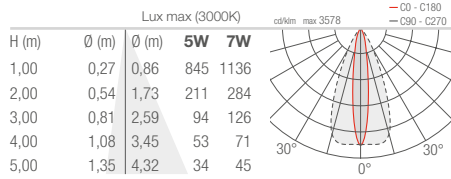

X - 46°x16° CRI 80

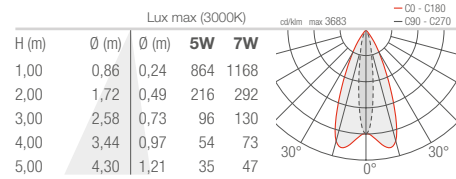

PIVOT 1.8

S - 20°

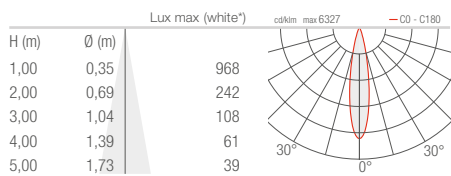

M - 33°

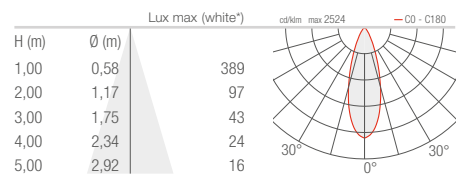

L - 45°

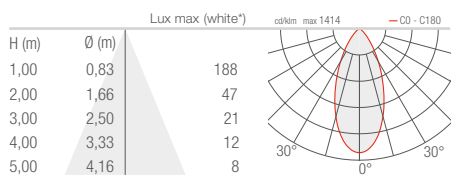

K - 58°

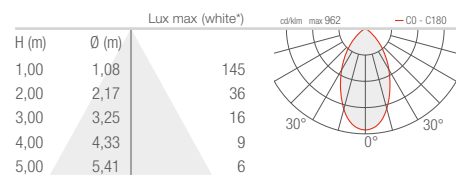

W - 22°x46°

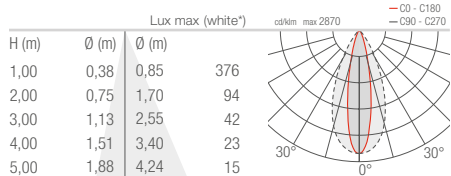

X - 46°x22°

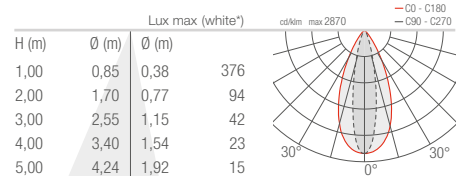

* White created by mixing the colours

PIVOT 2.0

S - 13° CRI 80

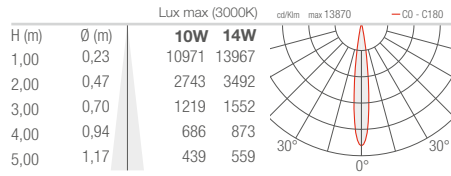

M - 25° CRI 80

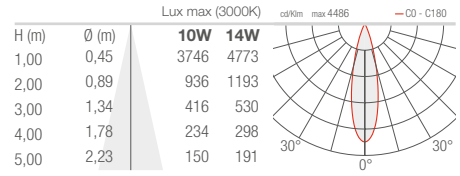

L - 37° CRI 80

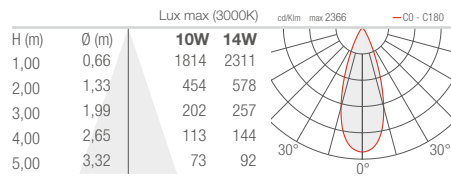

Q - 50° sharp CRI 80

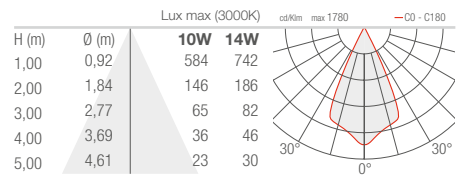

W - 13°x68° adjustable CRI 80

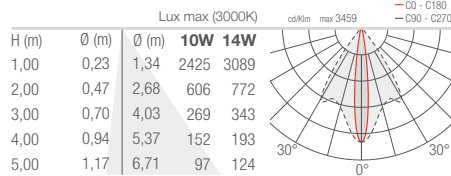

R3 - 15° (15°-43°) CRI 80

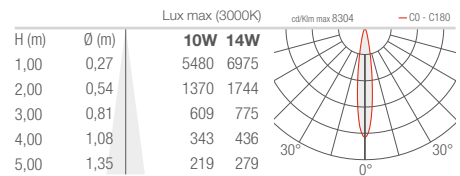

R3 - 43° (15°-43°) CRI 80

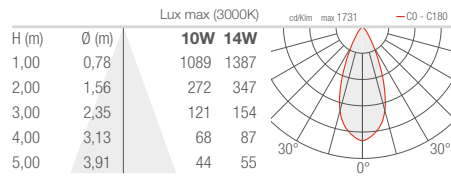

OUTDOOR BOLLARDS

PLIN 1.0

A - Diffuse

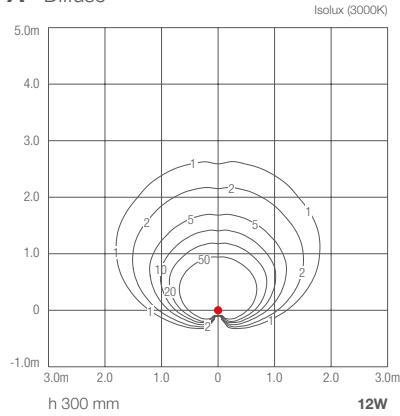

PLIN 1.1

A - Diffuse

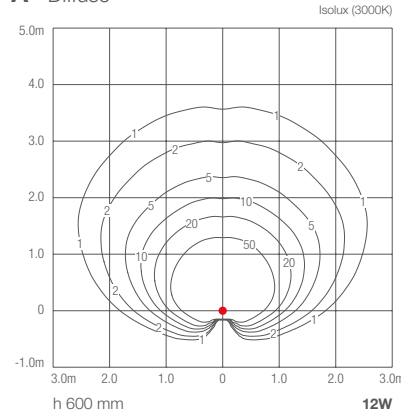

PLIN 1.2

A - Diffuse

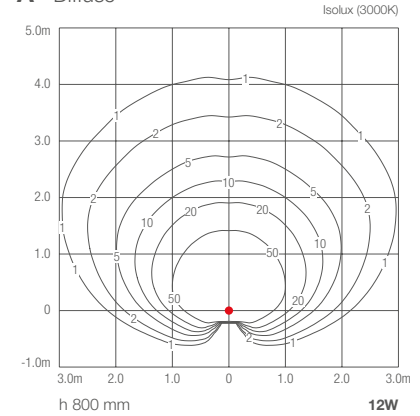

PLIN 2.0

A - Asymmetrical diffuse

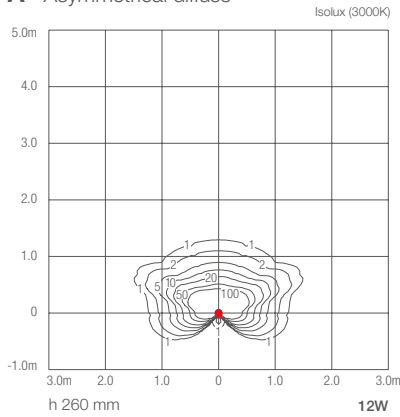

PLIN 2.1

A - Asymmetrical diffuse

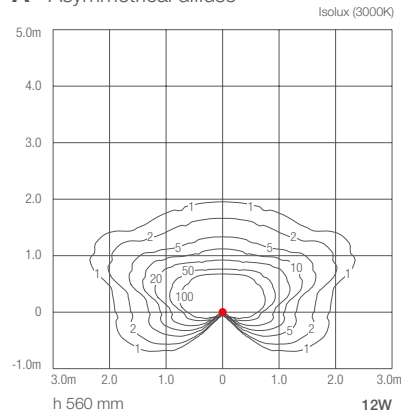

PLIN 2.2

A - Asymmetrical diffuse

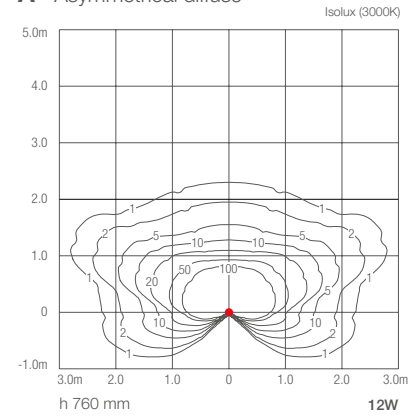

PLIN 3.0

A - Asymmetrical diffuse

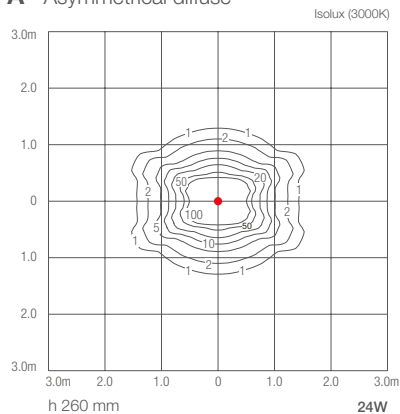

PLIN 3.1

A - Asymmetrical diffuse

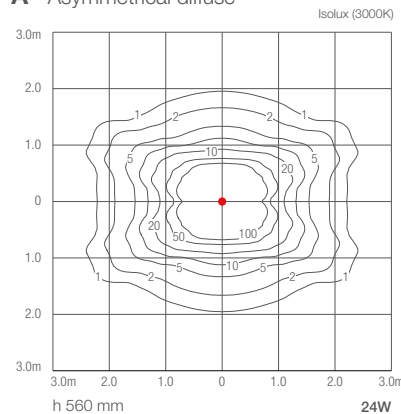

PLIN 3.2

A - Asymmetrical diffuse

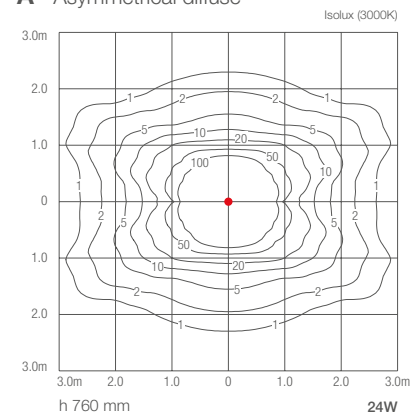

PLIN 4.0

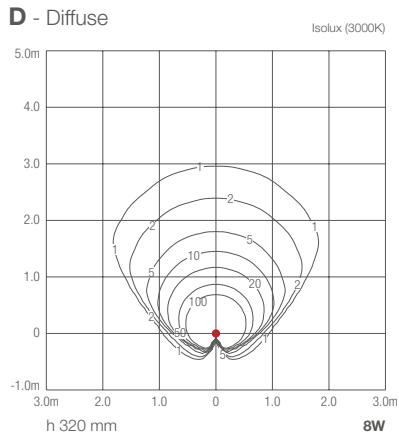

PLIN 4.1

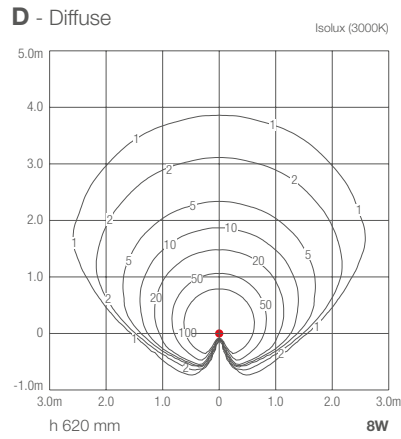

PLIN 4.2

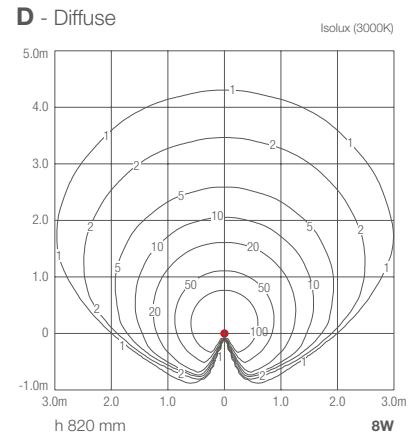

PLIN 5.0

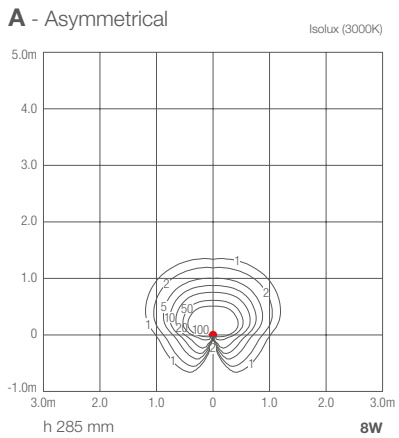

PLIN 5.1

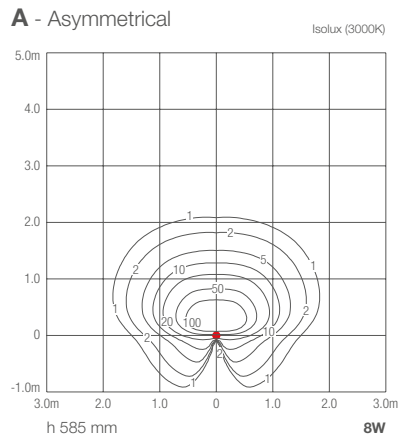

PLIN 5.2

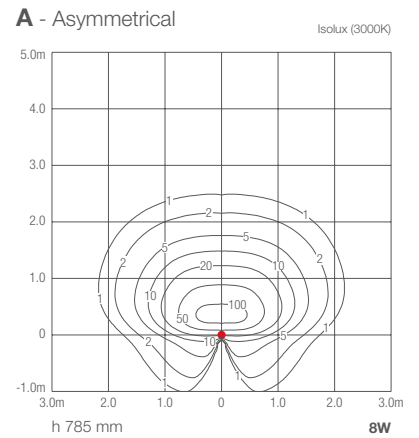

PLIN 6.0

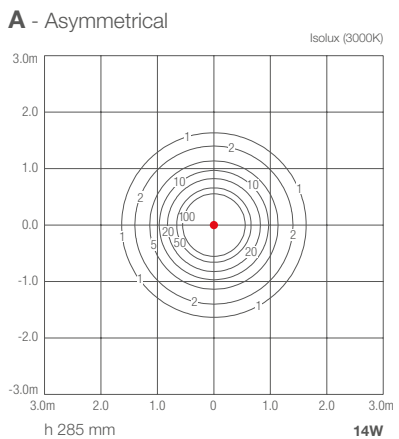

PLIN 6.1

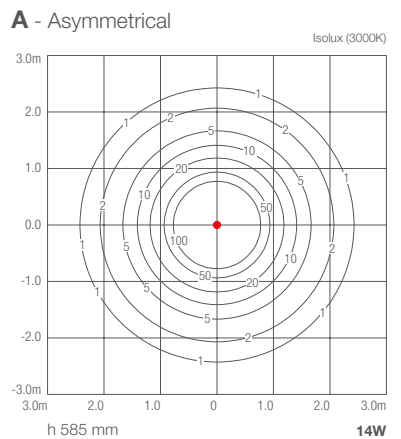

PLIN 6.2

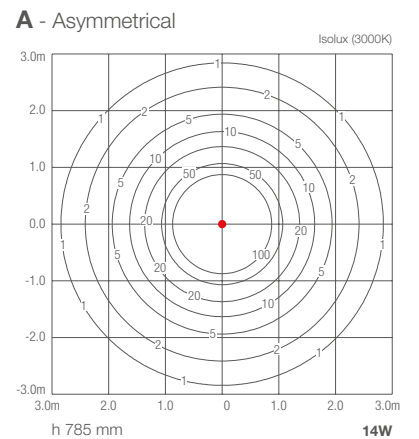



OUTDOOR RECESSED

QUAD 6.1

S - 12°

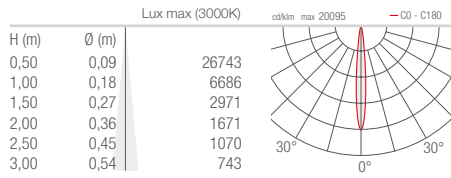

M - 24°

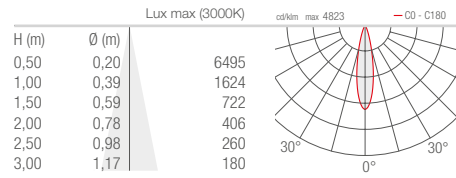

L - 56°

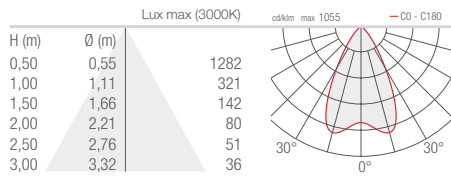

QUILATERO

INDOOR RECESSED

QUILATERO 1

V - 7° CRI 80

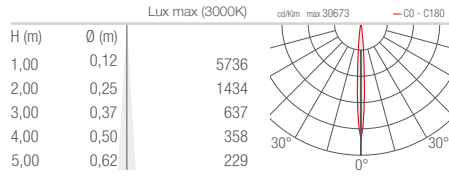

T - 10° CRI 80

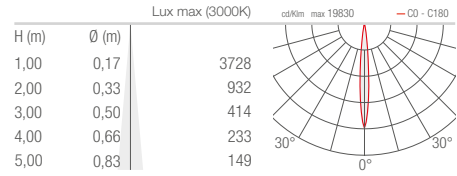

S - 14° CRI 80

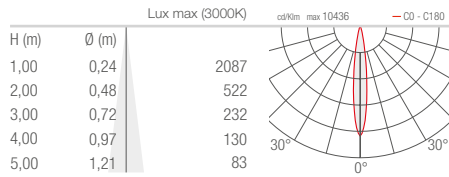

M - 32° CRI 80

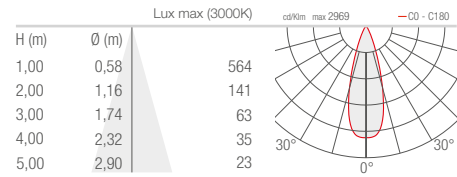

P - 35° CRI 80

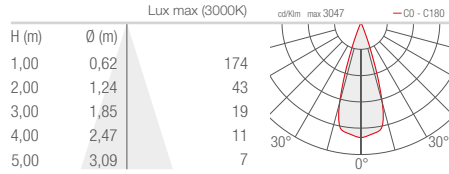

L - 42° CRI 80

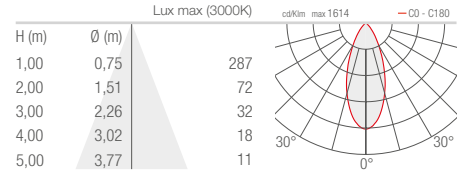

W - 12°x45° CRI 80

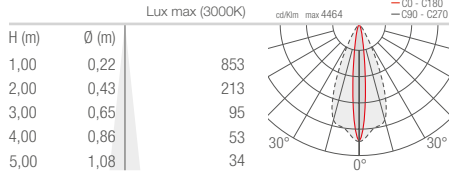

D - Diffuse CRI 80

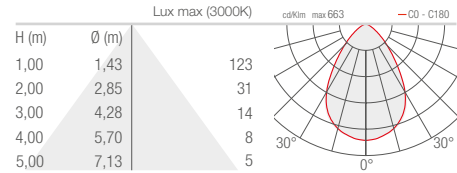

A - Wall washer CRI 80

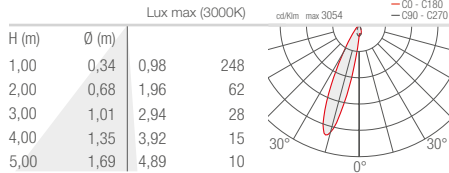

QUILATERO 2

V - 8° CRI 80

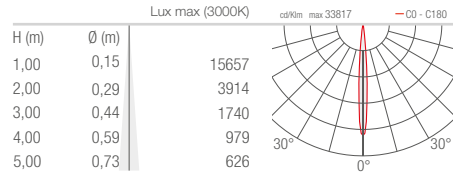

T - 12° CRI 80

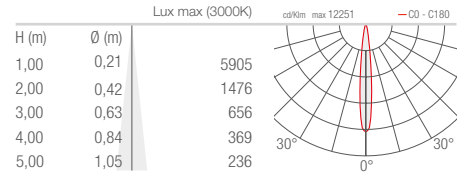

S - 18° CRI 80

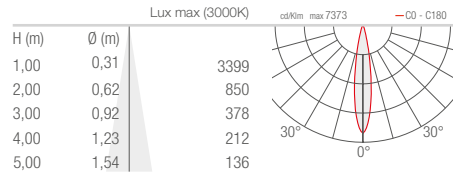

M - 34° CRI 80

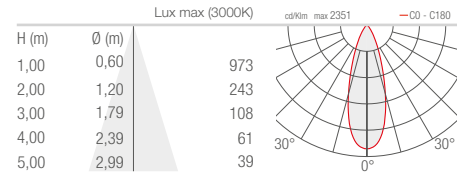

L - 47° CRI 80

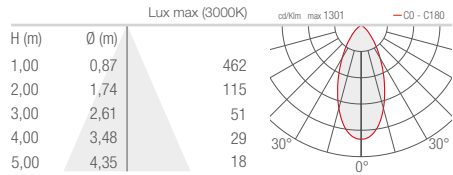

Q - 63° sharp CRI 80

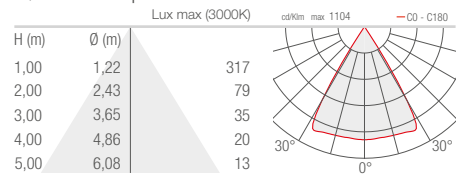

W - 20°x47° CRI 80

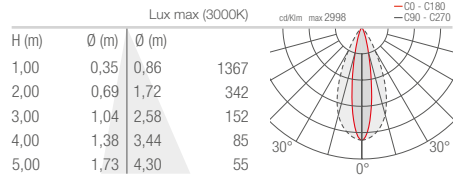

D - Diffuse CRI 80

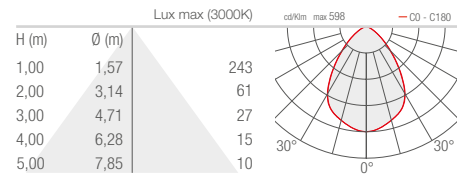

A - Wall washer CRI 80

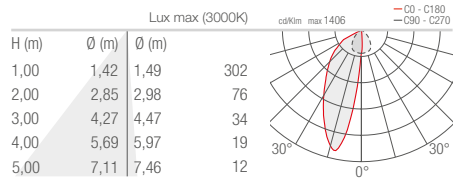

QUILATERO 3

S - 14° CRI 80

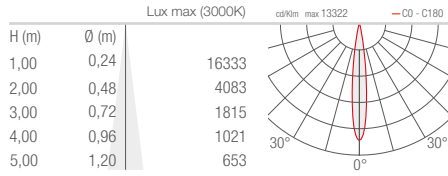

M - 26° CRI 80

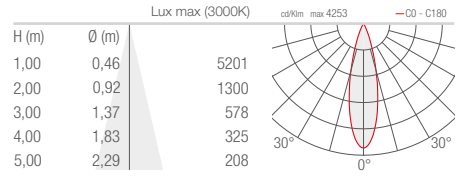

L - 39° CRI 80

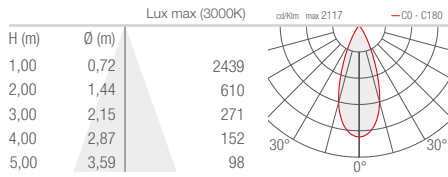

K - 57° CRI 80

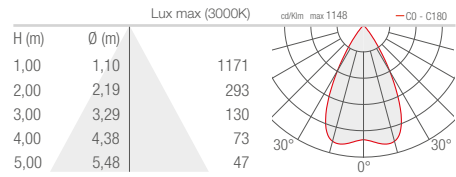

Q - 57° sharp CRI 80

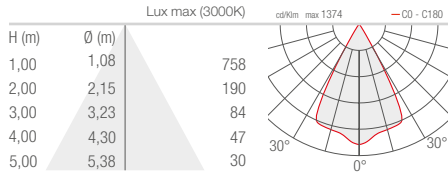

W - 14°x67° CRI 80

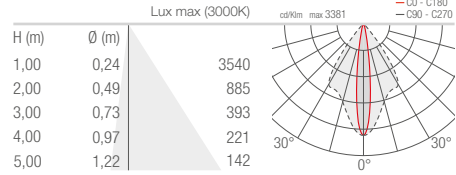

X - 25°x70° CRI 80

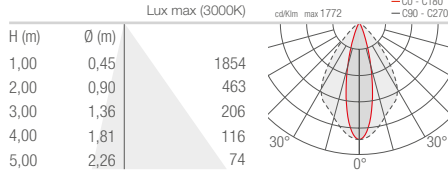

R3 - zoom 18° (18°-48°) CRI 80 (Quilatero 3.0 / 3.1)

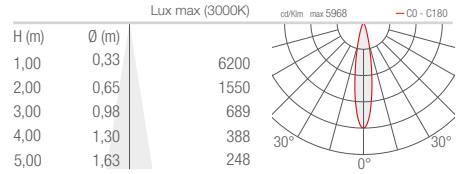

R3 - zoom 48° (18°-48°) CRI 80 (Quilatero 3.0 / 3.1)

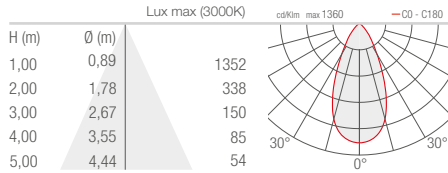

D - Diffuse CRI 80 (Quilatero 3.0 / 3.1)

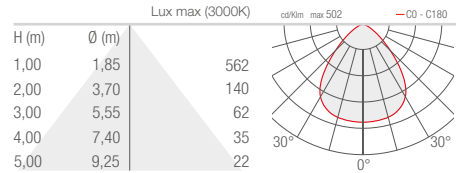

A - Wall washer CRI 80 (Quilatero 3.0 / 3.1)

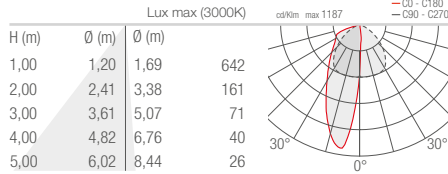

QUILATERO 4

S - 17° CRI 80

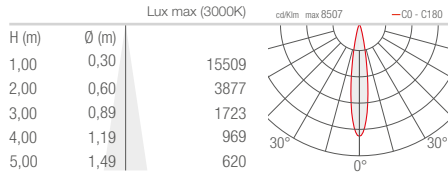

M - 24° CRI 80

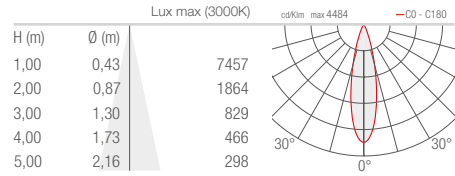

L - 32° CRI 80

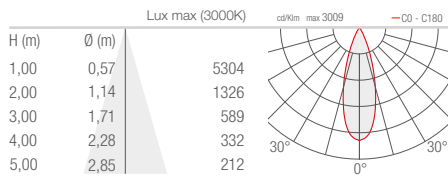

P - 43° sharp CRI 80

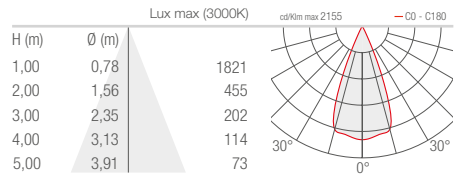

J - 53° CRI 80

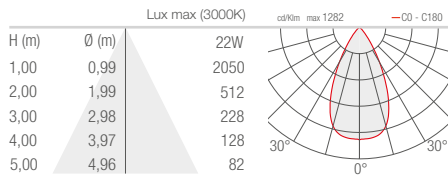

W - 17°x69° CRI 80

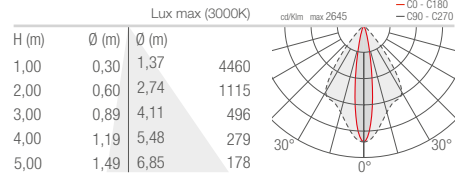

X - 30°x73° CRI 80

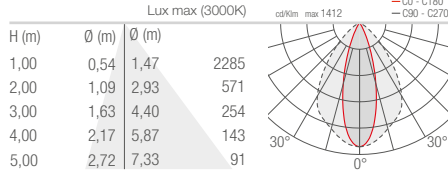

R3 - zoom 20° (20°-41°) CRI 80 (Quilatero 4.0 / 4.1)

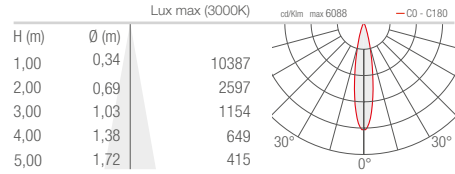

R3 - zoom 41° (20°-41°) CRI 80 (Quilatero 4.0 / 4.1)

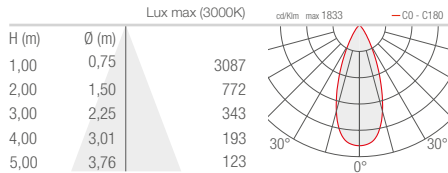

D - Diffuse CRI 80 (Quilatero 4.0 / 4.1)

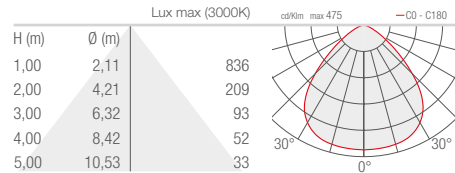

A - Wall washer CRI 80 (Quilatero 4.0 / 4.1)

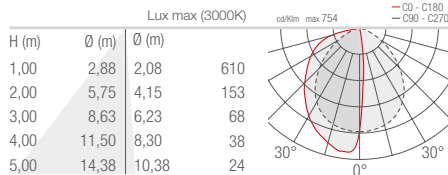

RIO 1.0

D - Diffuse

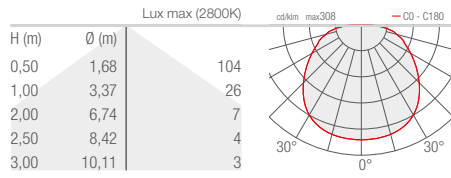

RIO 2.0

D - Diffuse

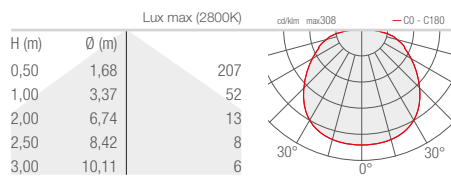

UNDERWATER LINEAR PROFILES

RIO SUB 1.1

D - Diffuse

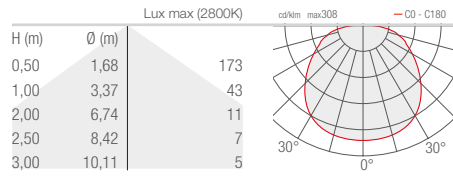

RIO SUB 2.1

D - Diffuse

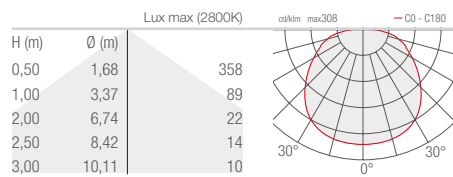

RONDÒ 1.1

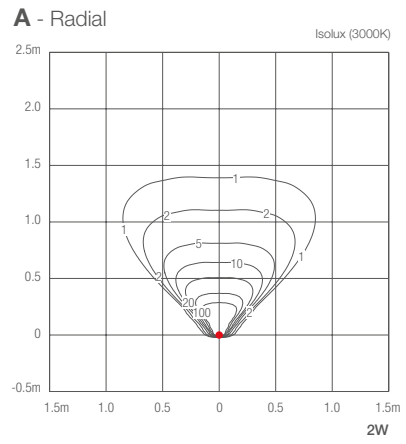
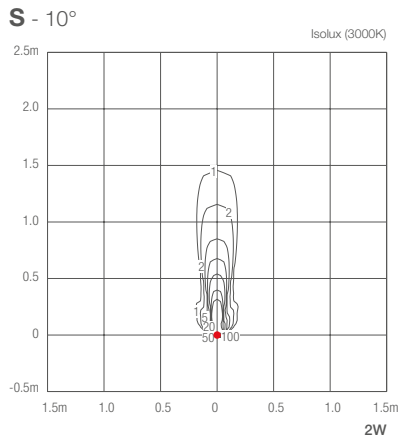

RONDÒ 2.1

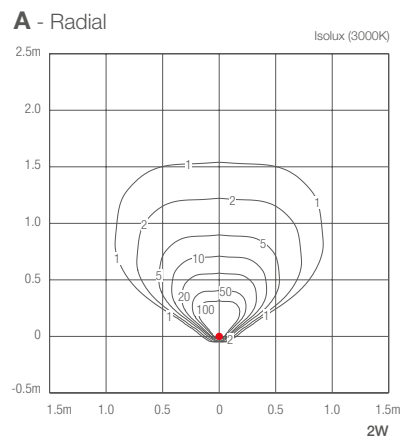
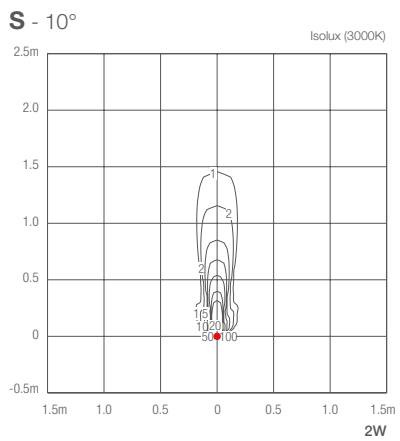

RONDÒ 3.1

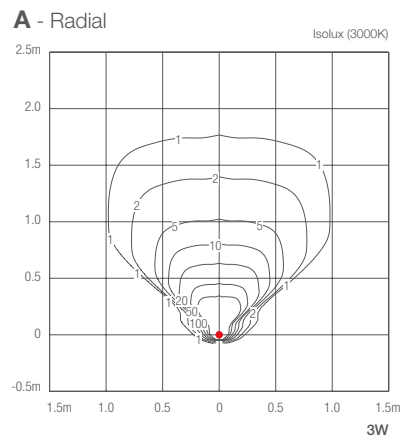
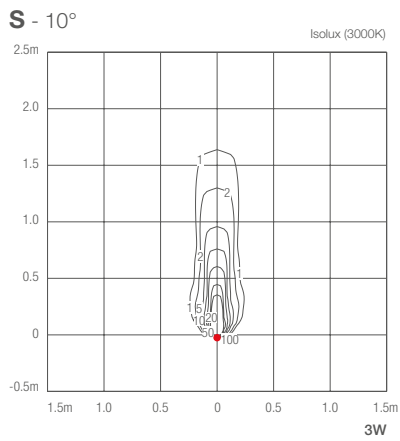

INDOOR STEP LIGHTS

SIMPLY 1.0

D - Diffuse

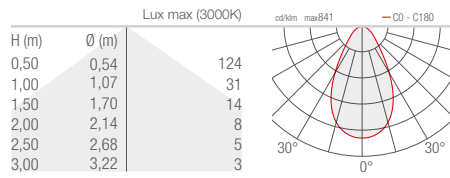

SIRI 1.0 1.1

V - 6°

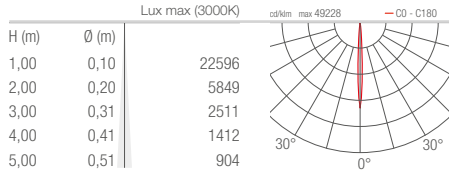

S - 12°

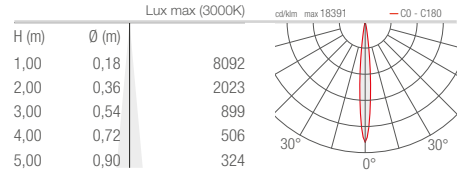

M - 30°

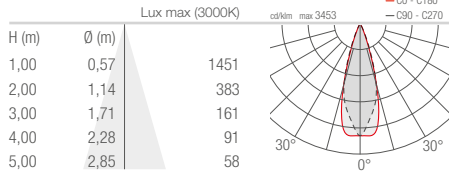

L - 40°

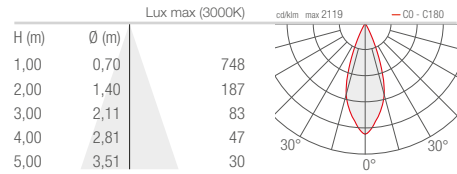

W - 10°x45°

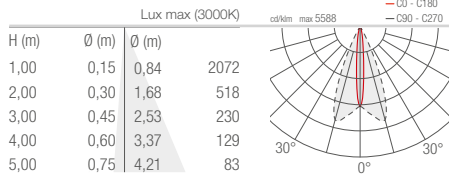

SIRI 1.2 1.3

S - 21°

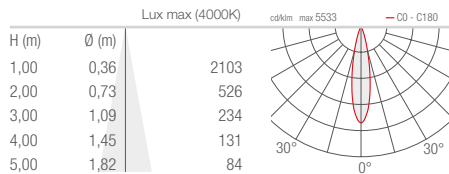

M - 32°

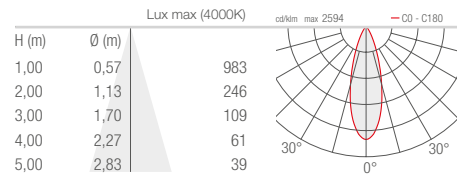

L - 58°

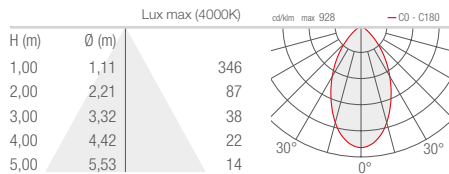

W - 30°x60°

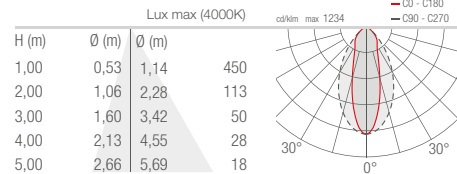

X - 60°x30°

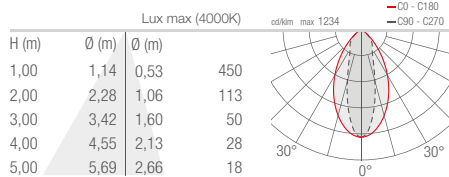

SIRI 2.0
2.1

V - 6°

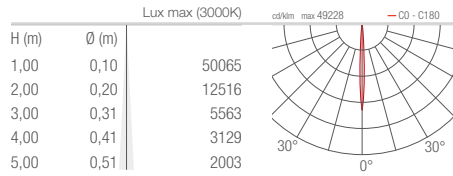

S - 12°

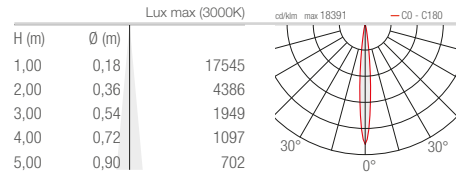

M - 30°

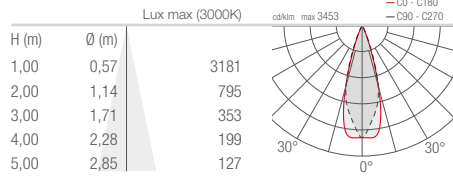

L - 40°

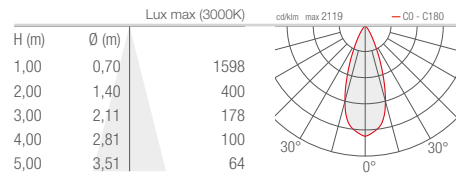

W - 10°x45°

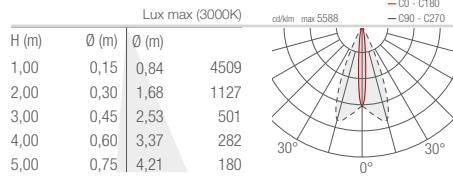

SIRI 2.2
2.3

S - 21°

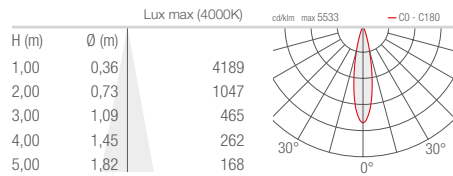

M - 32°

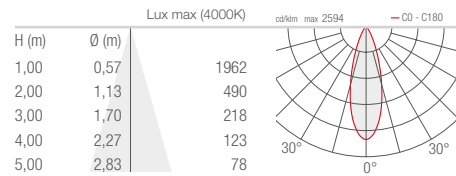

L - 58°

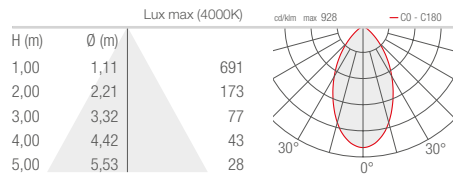

W - 30°x60°

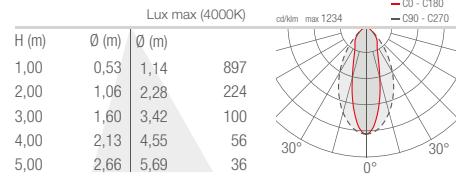

X - 60°x30°

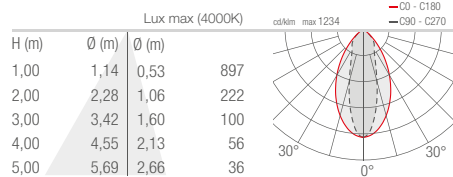

SIRI 3.0 3.1

V - 6°

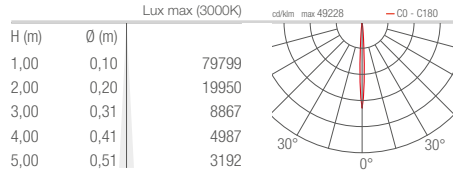

S - 12°

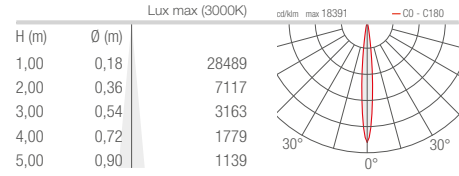

M - 30°

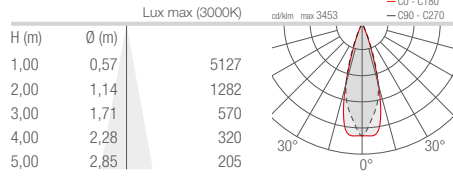

L - 40°

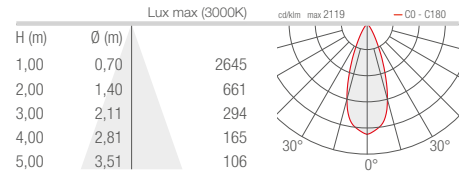

W - 10°x45°

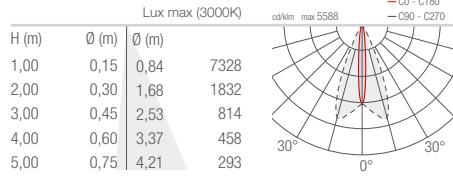

SIRI 3.2 3.3

S - 21°

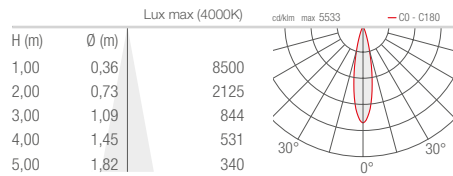

M - 32°

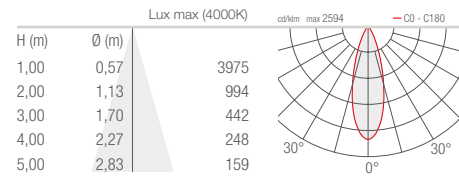

L - 58°

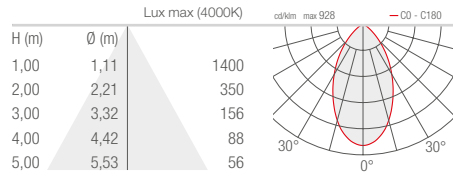

W - 30°x60°

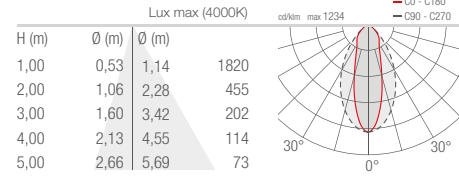

X - 60°x30°

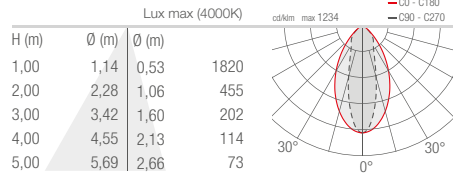

URBAN LIGHTING

SIRI BLVD 1.0 2.0 3.0

A - Pedestrian zone

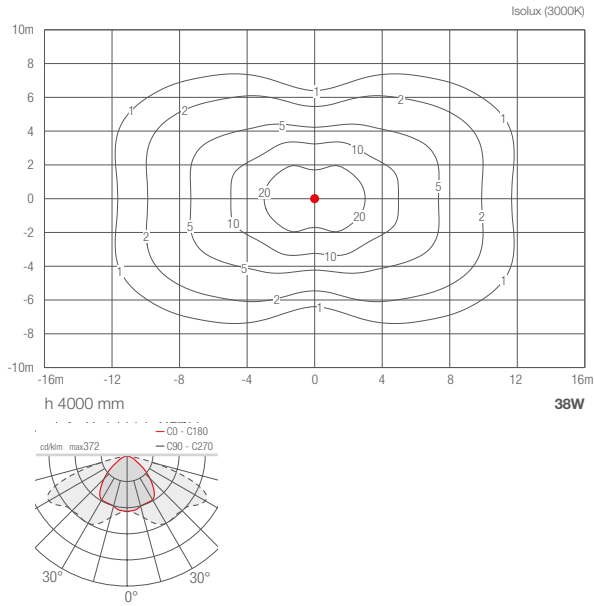

B - Asymmetrical

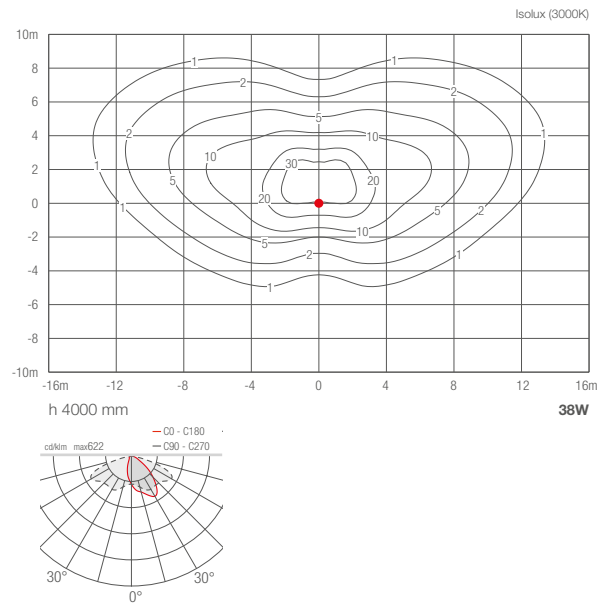

C - Footpath

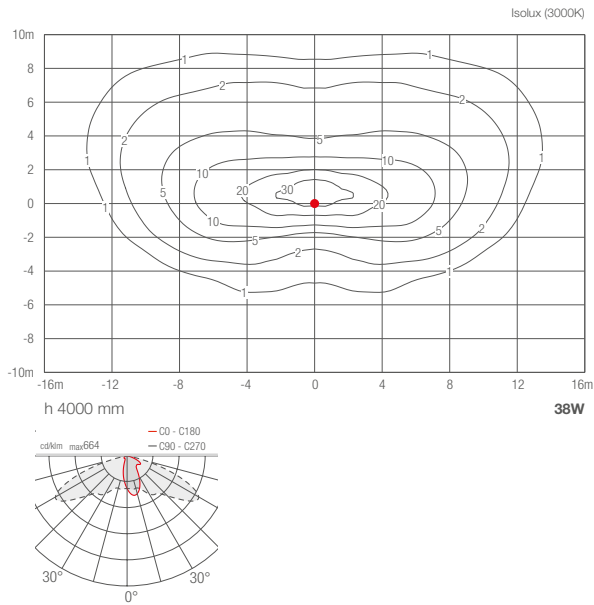

D - Cycle path

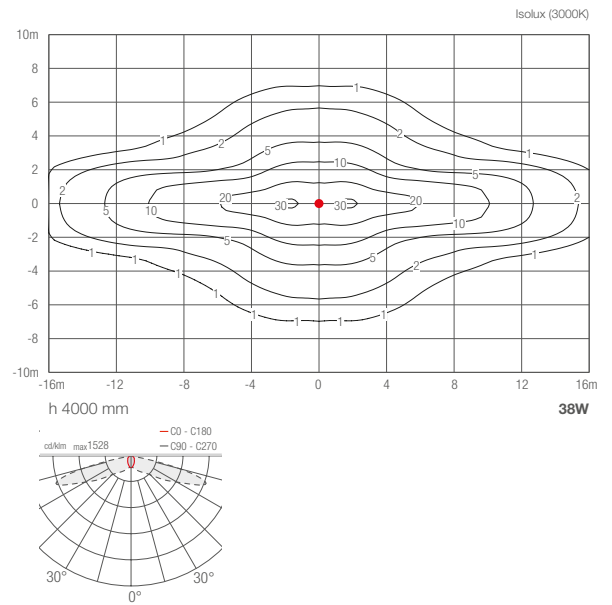

SMOOTHY

OUTDOOR RECESSED

SMOOTHY 1.0

S - 13° CRI 80

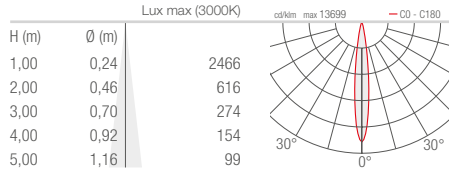

M - 22° CRI 80

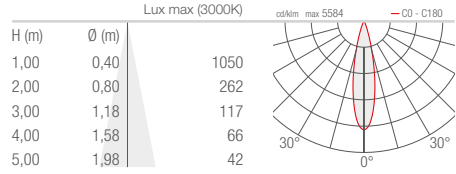

F - 30° CRI 80

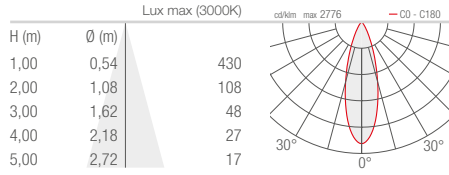

P - 35° sharp CRI 80

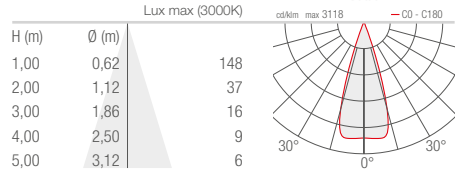

L - 48° CRI 80

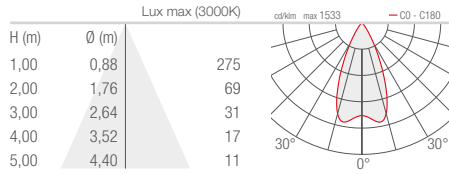

D - Diffuse CRI 80

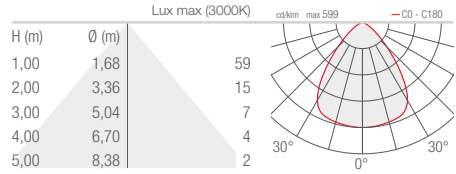

SMOOTHY 1.6 2.8

S - 13° CRI 80

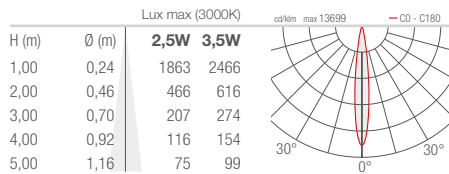

M - 22° CRI 80

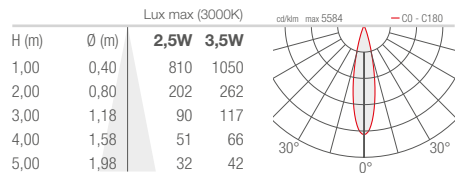

F - 30° CRI 80

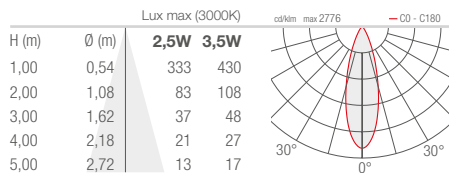

P - 35° sharp CRI 80

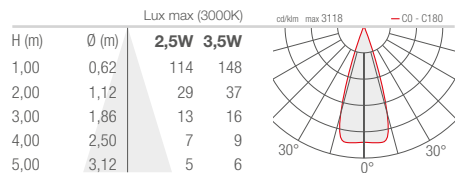

L - 48° CRI 80

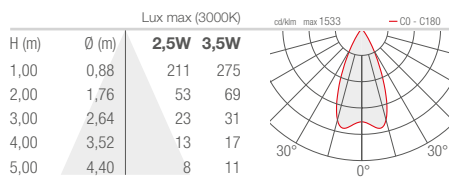

D - Diffuse CRI 80 (Smoothy 1.6)

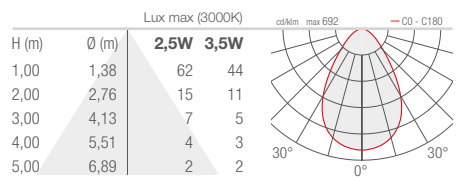

SMOOTHY 2.4
5.6

U - 5° CRI 80

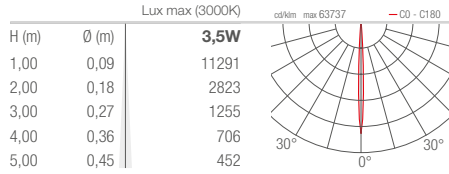

V - 8° CRI 80

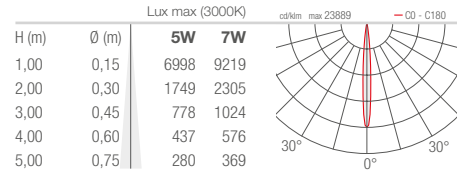

T - 11° CRI 80

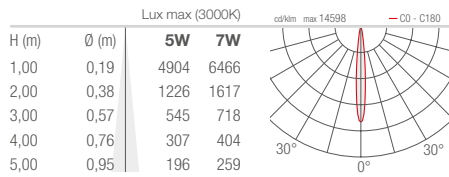

S - 17° CRI 80

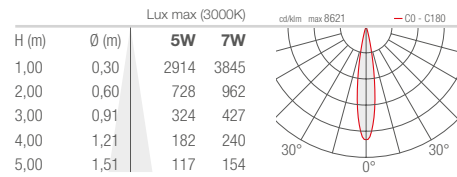

P - 21° sharp CRI 80

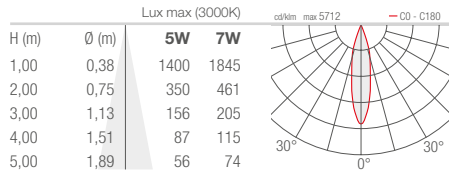

M - 34° CRI 80

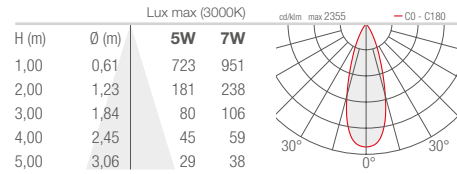

L - 45° CRI 80

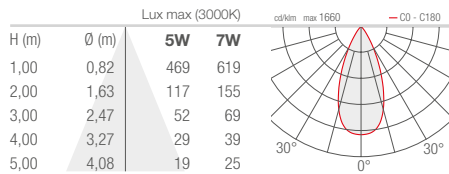

Q - 61° sharp CRI 80

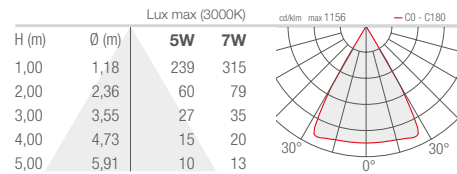

W - 13°x52° CRI 80

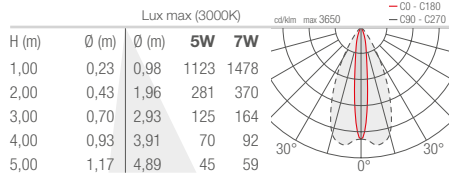

D - Diffuse CRI 80 (Smoothy 2.4)

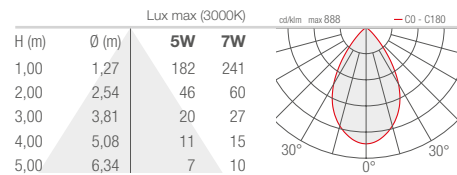

SMOOTHY 5.4

S - 16° CRI 80

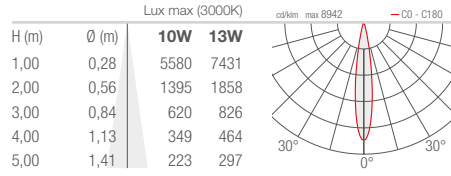

M - 21° CRI 80

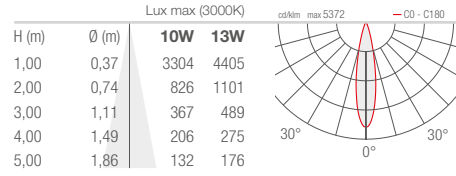

L - 38° CRI 80

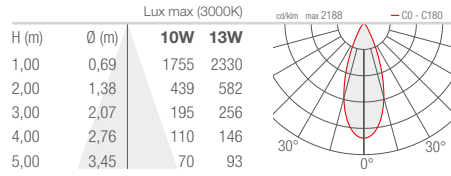

P - 58° sharp CRI 80

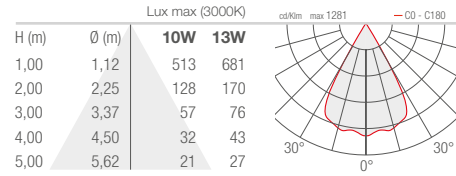

K - 55° CRI 80

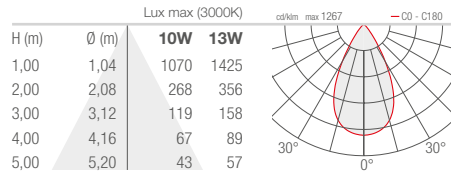

W - 16°x69° adjustable CRI 80

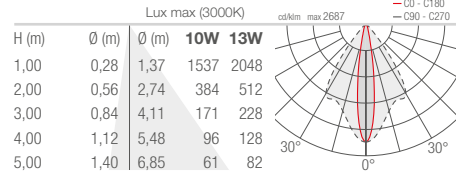

D - Diffuse CRI 80

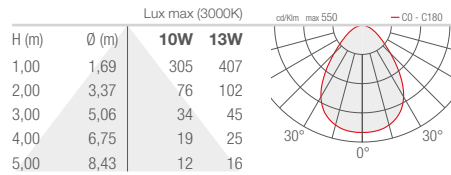



OUTDOOR PROJECTORS

SPOT 1.0 1.6

S - 10°

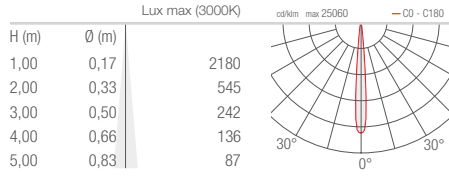

V - 19° sharp

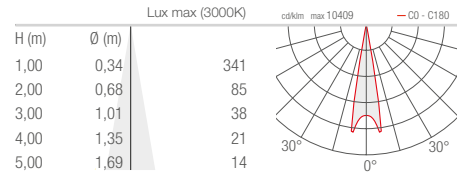

M - 20°

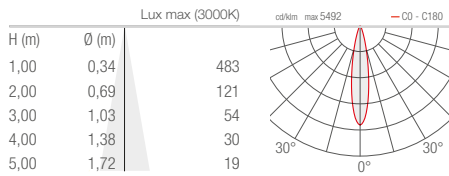

L - 40°

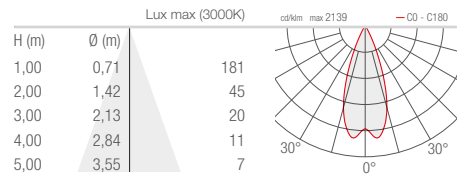

T - 54° sharp

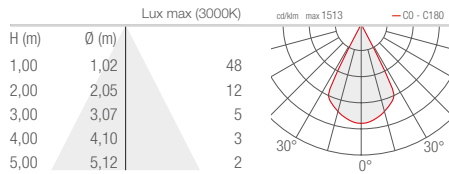

SPOT 2.4

S - 21°

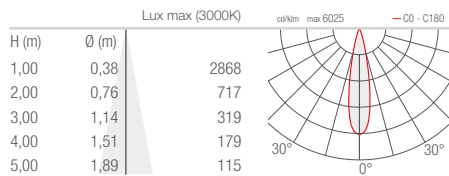

M - 29°

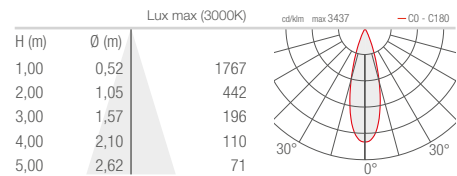

L - 58°

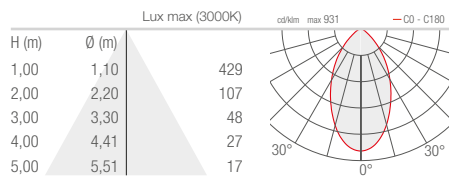

SPOT 3.4

S - 15°

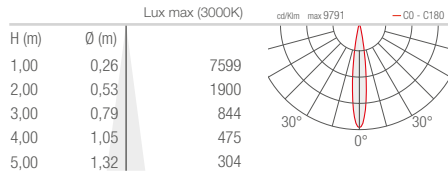

M - 39°

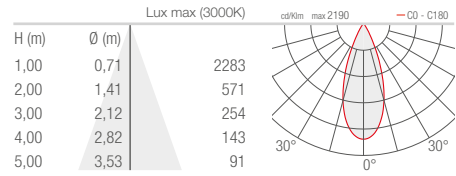

L - 55°

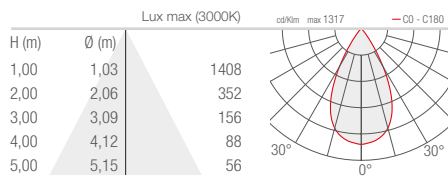

SPOT 4.4

S - 15°

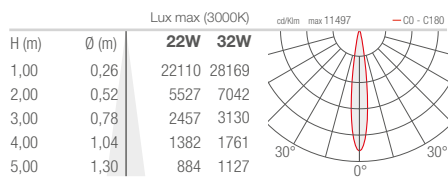

M - 24°

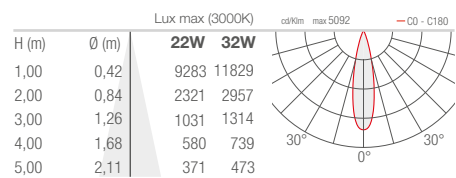

L - 32°

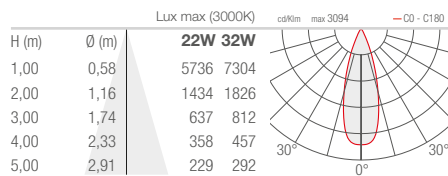

J - 54°

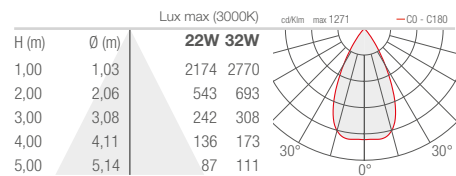

UNDERWATER AND OUTDOOR PROJECTORS

SPOT 1.0 316L 1.6 316L

S - 10°

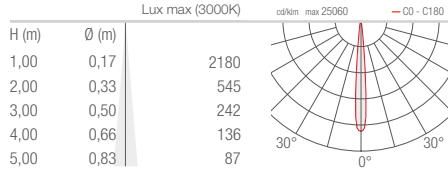

M - 20°

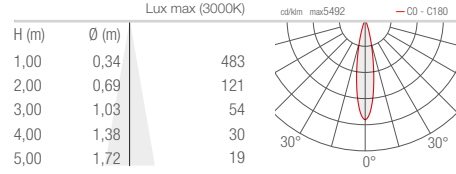

L - 40°

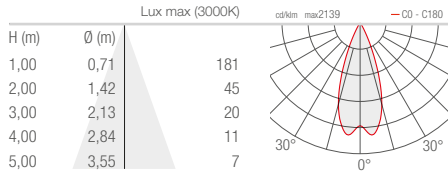

SPOT 2.0 316L 2.6 316L

S - 10°

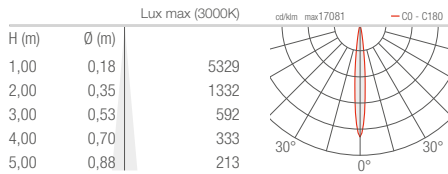

M - 24°

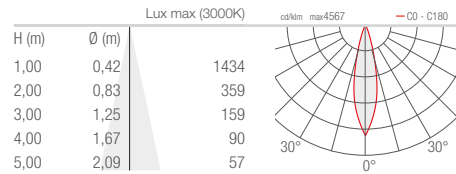

L - 38°

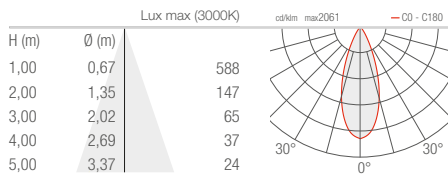

SPOT 3.0 316L

S - 10°

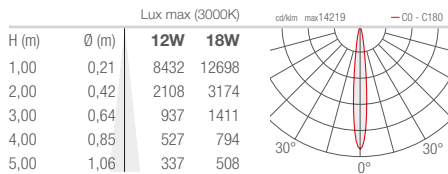

M - 20°

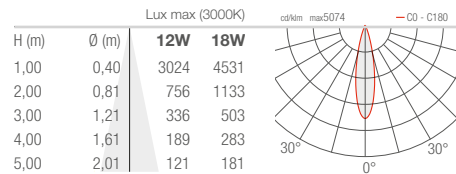

L - 40°

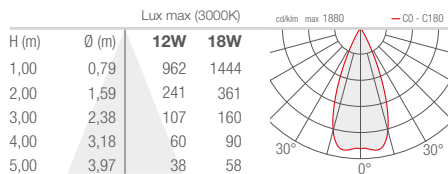

STEP INSIDE

INDOOR STEP LIGHTS

STEP INSIDE 2.2

2.3

2.8

2.9

D - Diffuse

Isolux (3000K)

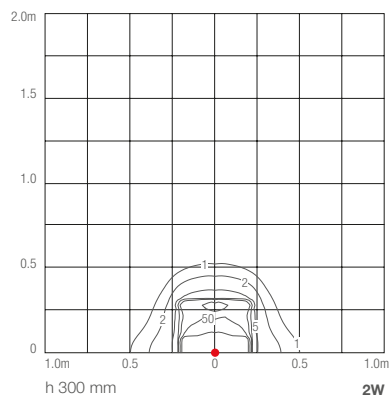

**STEP
OUTSIDE 2.0
2.1
2.6
2.7**

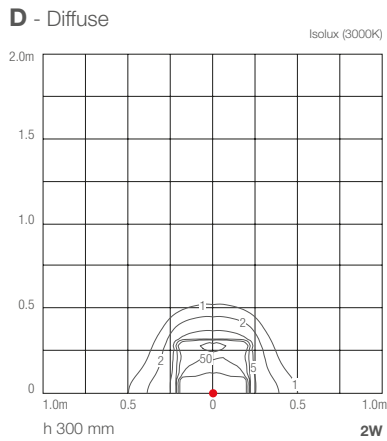

**STEP
OUTSIDE 5.1**

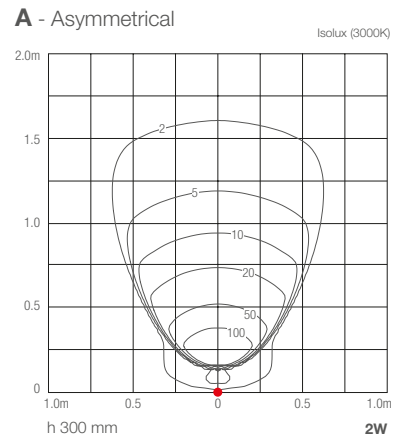

**STEP
OUTSIDE 5.2**

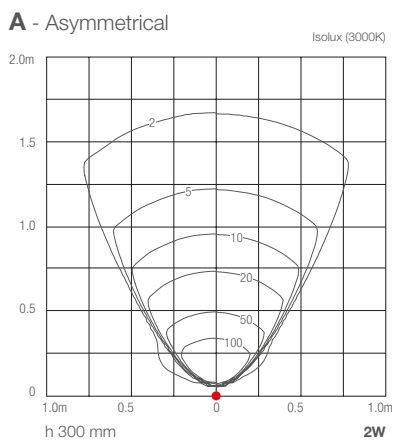

**STEP
OUTSIDE 6.1**

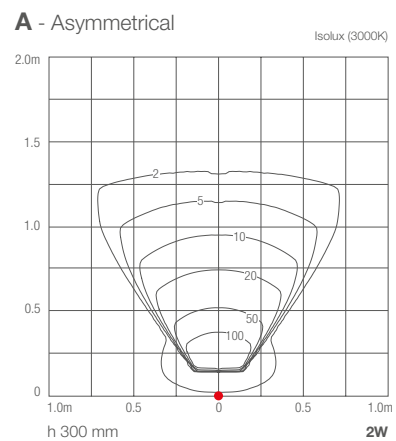

**STEP
OUTSIDE 6.2**

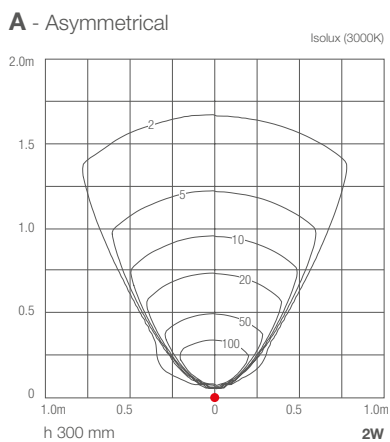

**STEP
OUTSIDE 6.3**

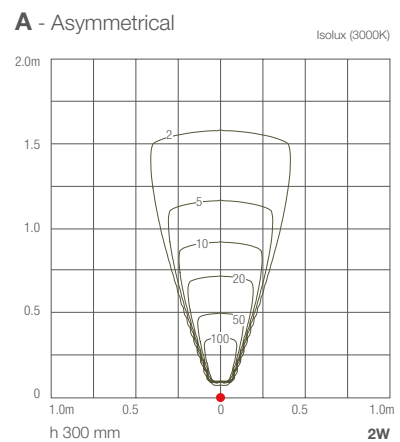

**STEP
OUTSIDE 7.0**

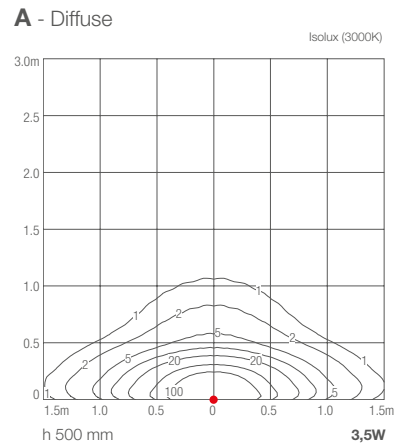
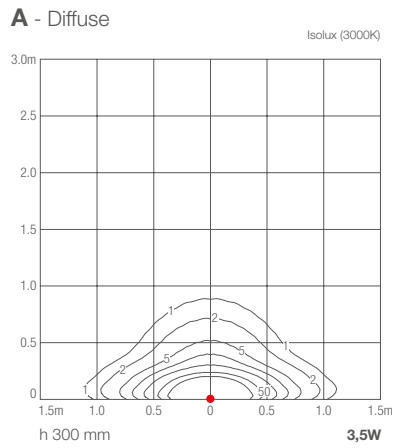

**STEP
OUTSIDE 8.0**

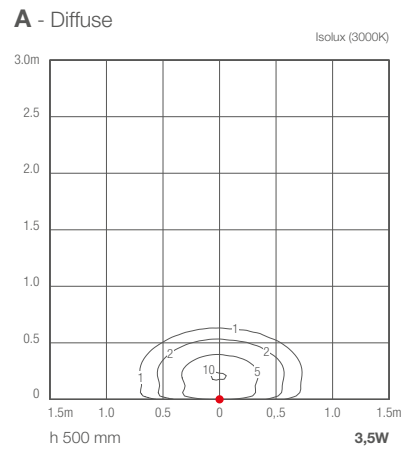
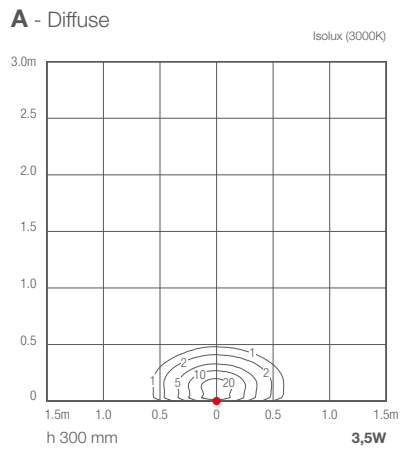



OUTDOOR RECESSED

STRA 1.0

V - 11° CRI 80

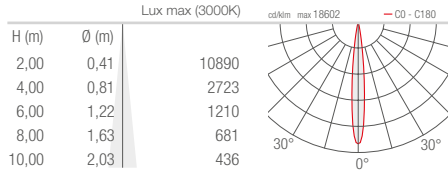

S - 14° CRI 80

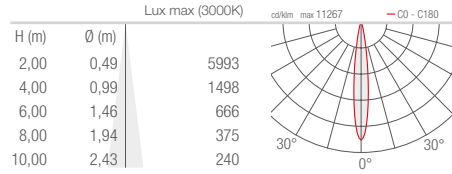

M - 30° CRI 80

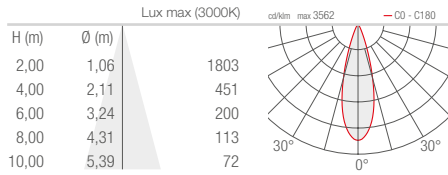

L - 37° CRI 80

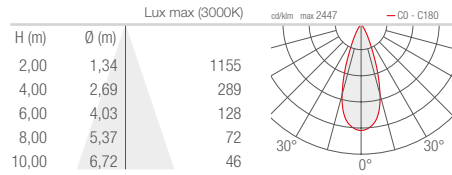

W - 10°x45° CRI 80

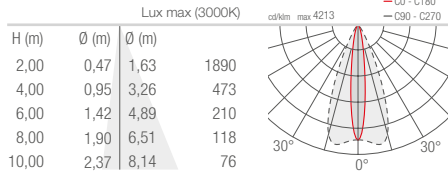

X - 66°x11° adjustable CRI 80

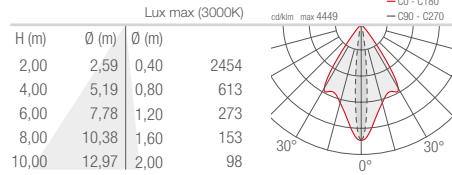

H - Wall washer CRI 80

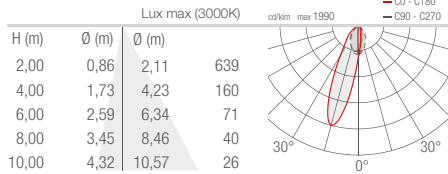

STRA 2.0

V - 11° CRI 80

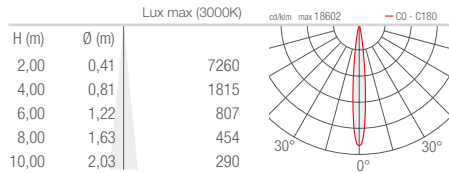

S - 14° CRI 80

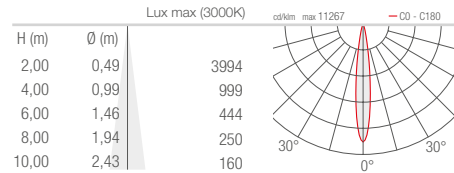

M - 30° CRI 80

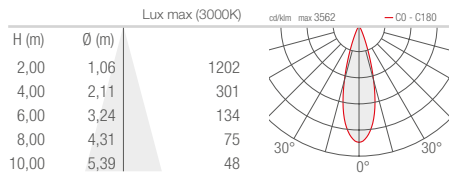

L - 37° CRI 80

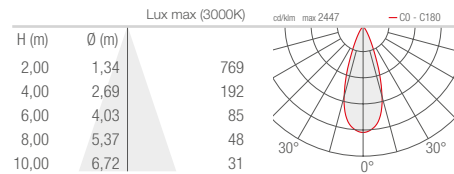

W - 10°x45° CRI 80

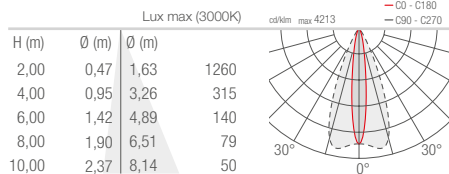

STRA 3.0 4.0

V - 11° CRI 80 (Stra 3.0)

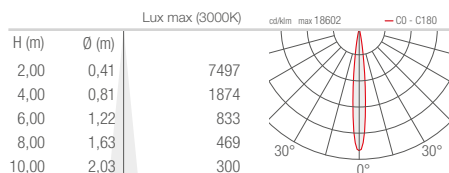

S - 14° CRI 80

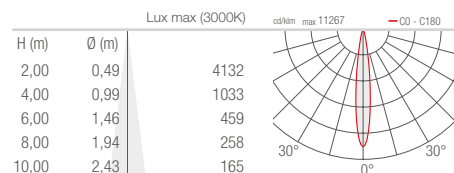

M - 30° CRI 80

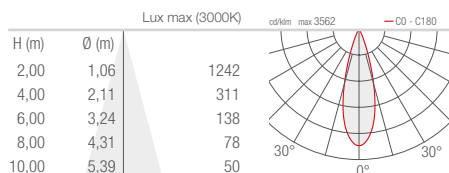

L - 37° CRI 80

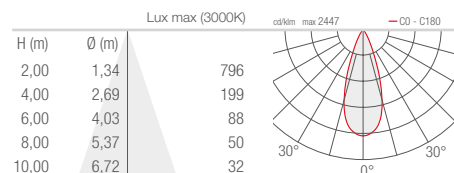

W - 10°x45° CRI 80

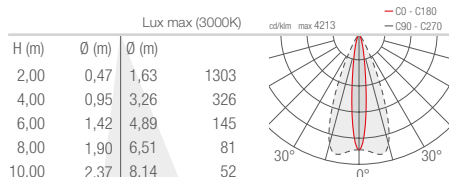

STRA 5.0

S - 24°

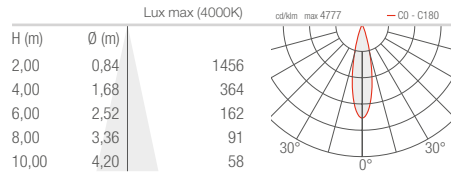

M - 33°

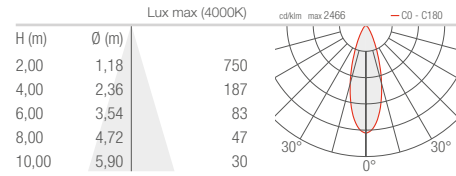

L - 60°

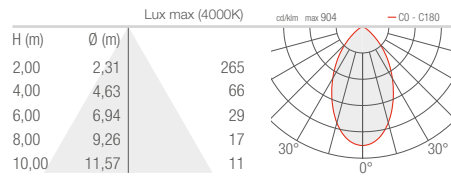

W - 32°x61°

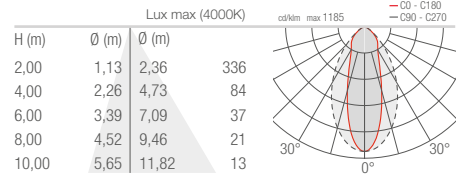

X - 66°x11° adjustable

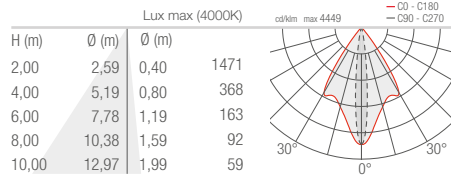

H - Wall washer

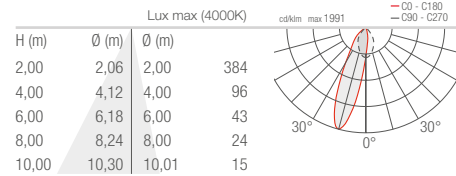

STRA P 1.0

V - 11° CRI 80

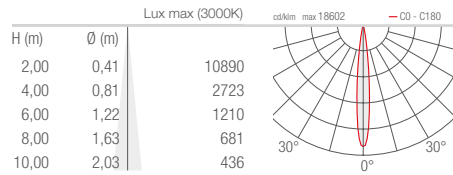

S - 14° CRI 80

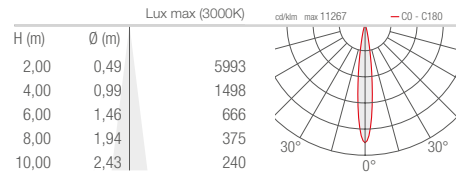

M - 30° CRI 80

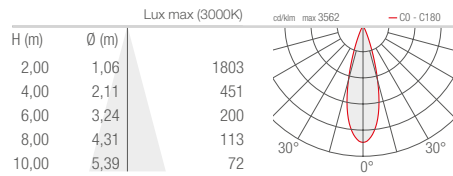

L - 37° CRI 80

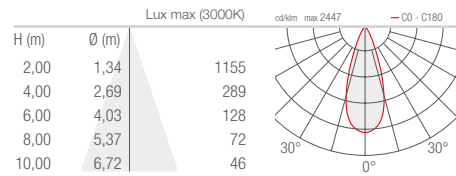

W - 10°x45° CRI 80

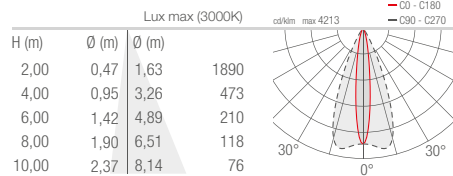

X - 66°x11° adjustable CRI 80

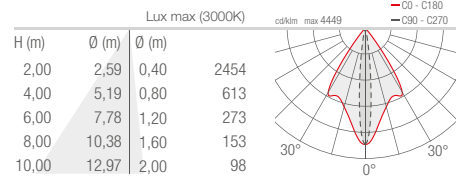

STRA P 5.0

S - 24°

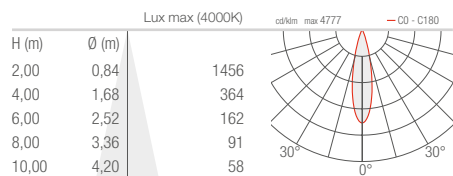

M - 33°

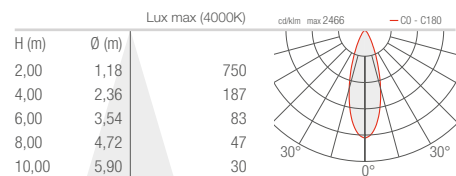

L - 60°

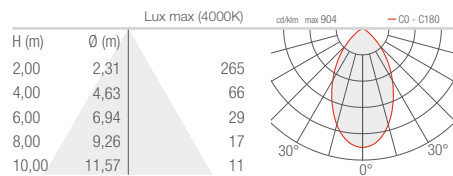

W - 32°x61°

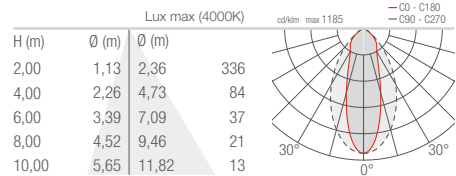

Z - 61°x32°

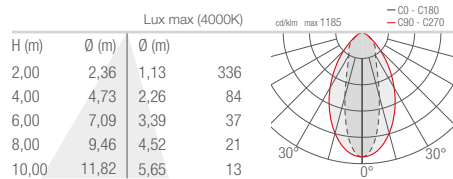

X - 66°x11° adjustable

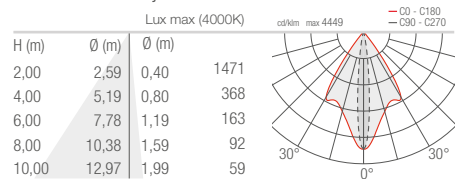



OUTDOOR LINEAR PROFILES

TAGO 1.0 2.0 3.0

S - 11°

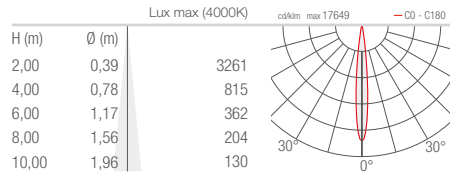

M - 17°

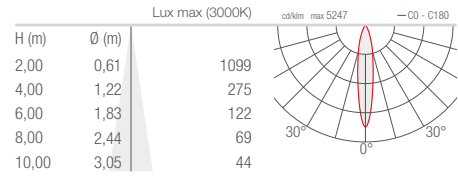

L - 29°

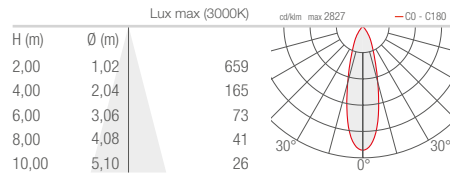

K - 69°

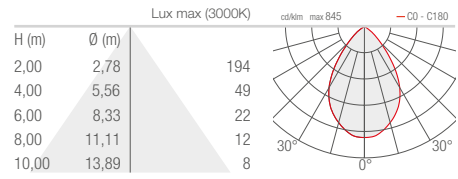

W - 20°x49°

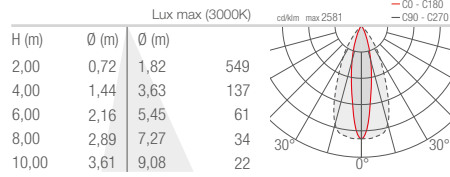

G - Wall grazing

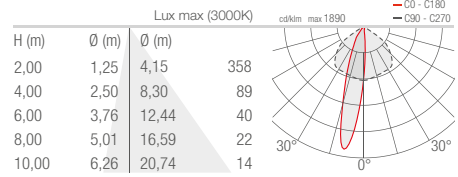

A - Wall washer

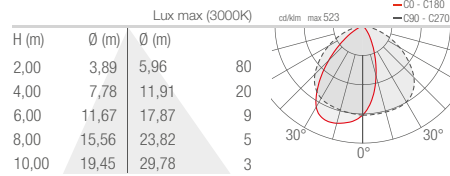

TAGO 4.0
5.0
6.0

S - 24°

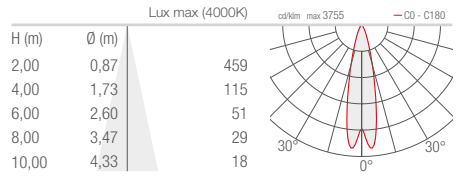

M - 31°

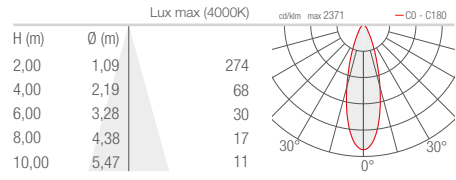

L - 52°

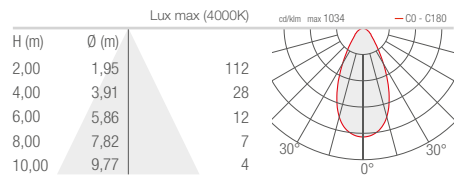



OUTDOOR CEILING MOUNTED

TAK 1.0

D - Diffuse

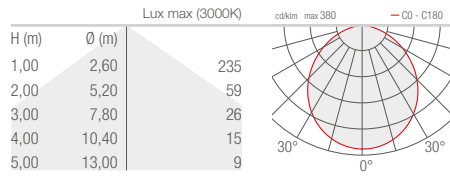

TAK 1.1

S - 10°

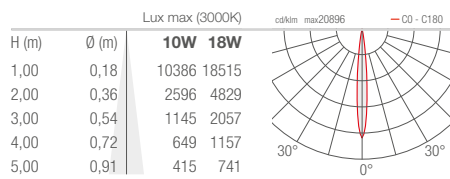

F - 30°

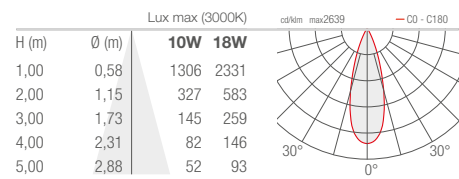

K - 70°

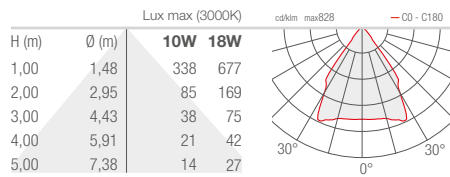

TEKO 5.0

D - Diffuse

		Lux max (3000K)		cd/klm max487		-00 - C180	
H (m)	Ø (m)	5W	9W				
1,00	1,95	161	288				
2,00	3,89	40	72				
3,00	5,84	18	32				
4,00	7,78	10	18				
5,00	9,73	6	12				

TEKO 5.1

D - Diffuse

		Lux max (3000K)		cd/klm max535		-00 - C180	
H (m)	Ø (m)	5W	9W				
1,00	1,95	175	366				
2,00	3,89	44	92				
3,00	5,84	19	41				
4,00	7,78	11	23				
5,00	9,73	7	15				

TEKO 7.0

D - Diffuse

		Lux max (3000K)		cd/klm max487		-00 - C180	
H (m)	Ø (m)	9W	17W				
1,00	1,95	288	543				
2,00	3,89	72	136				
3,00	5,84	32	60				
4,00	7,78	18	34				
5,00	9,73	12	22				

TEKO 7.1

D - Diffuse

		Lux max (3000K)		cd/klm max535		-00 - C180	
H (m)	Ø (m)						
1,00	1,95	366					
2,00	3,89	92					
3,00	5,84	41					
4,00	7,78	23					
5,00	9,73	15					

OUTDOOR AND UNDERWATER LINEAR PROFILES

TREVI 1.0

M - 40°

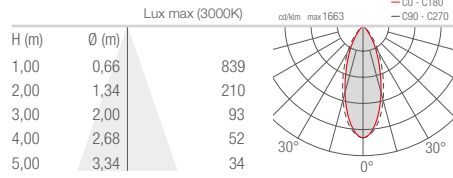

L - 65°

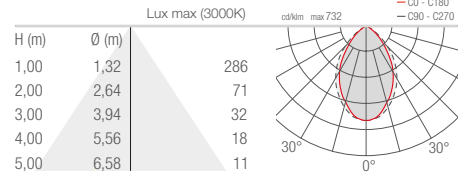

W - 20°x50°

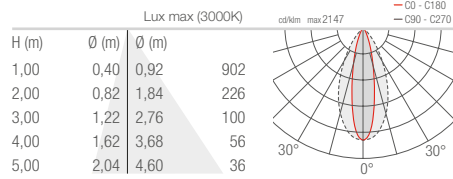

D - Diffuse

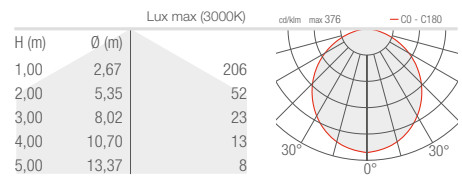

TURIS MINI 1.0

D - Diffuse

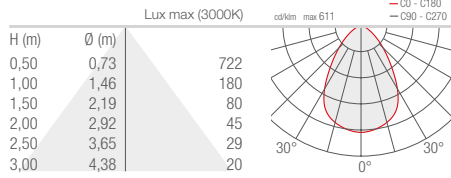

TURIS MINI 1.1

D - Diffuse

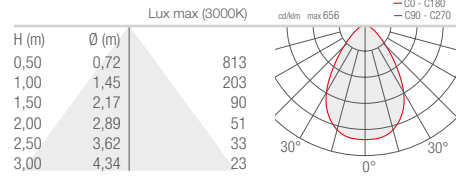

TURIS 1.0 2.0

D - Diffuse

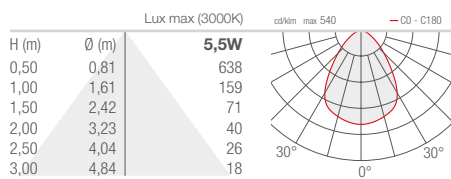

D - Diffuse

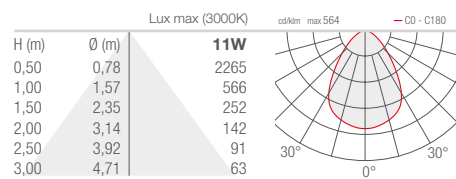

TURIS 1.1

D - Diffuse

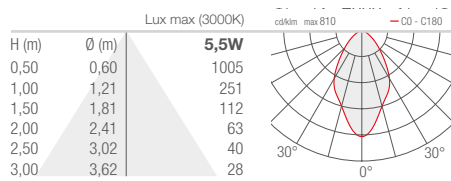

D - Diffuse

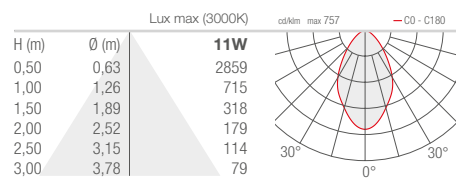

TURIS 1.2

D - Diffuse

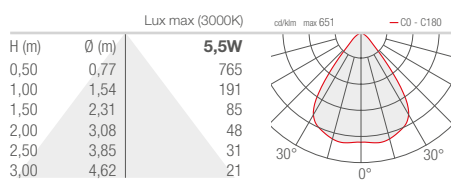

D - Diffuse

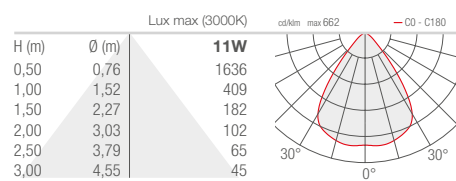

TURIS 1.3

D - Diffuse

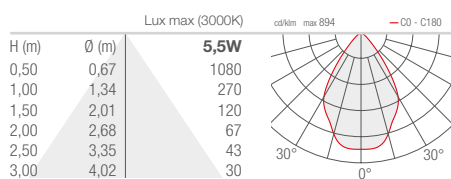

D - Diffuse

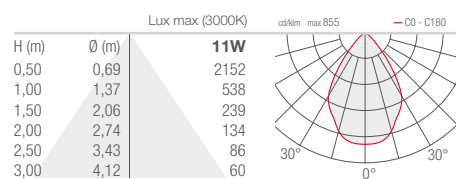

TURIS 3.0
4.0

D - Diffuse

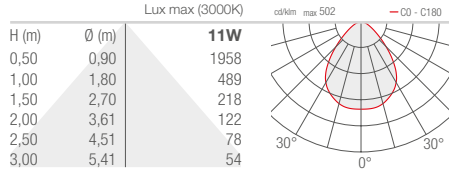

D - Diffuse

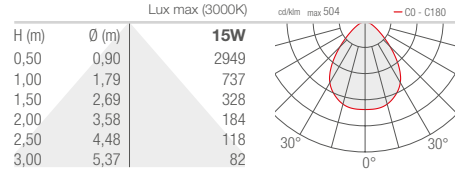

TURIS 3.1

D - Diffuse

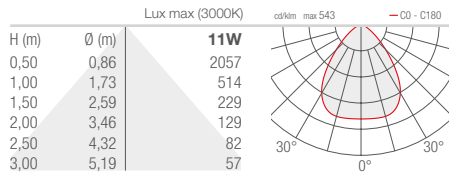

D - Diffuse

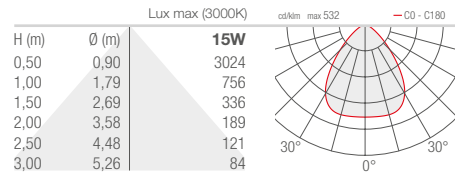

TURIS 3.2

D - Diffuse

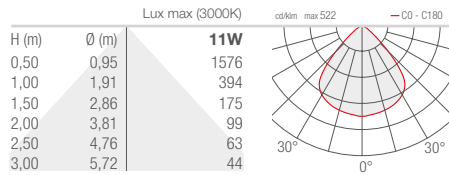

D - Diffuse

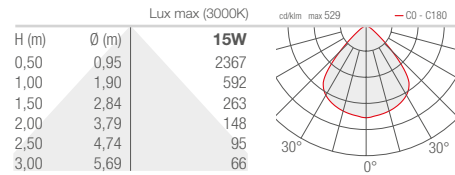

TURIS 3.3

D - Diffuse

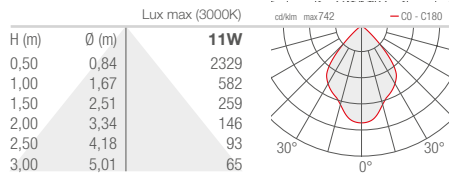

D - Diffuse

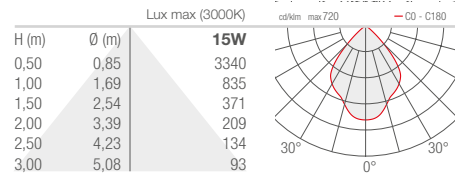

TURIS 5.0
5.1

D - Diffuse

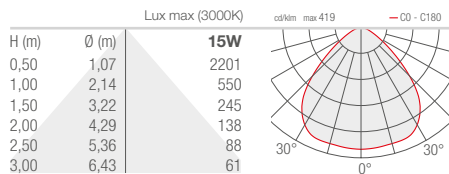

D - Diffuse

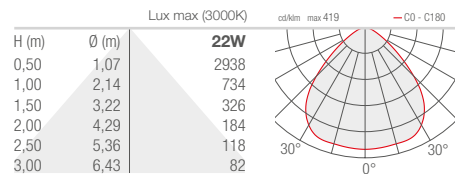

UPDOWN

OUTDOOR WALL MOUNTED

UPDOWN 3.0 3.6

S - 15°

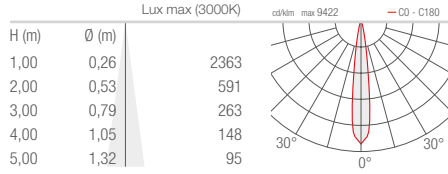

M - 22°

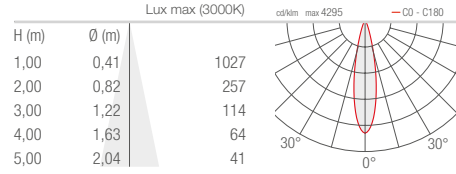

L - 54°

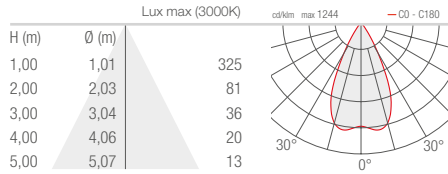

UPDOWN 4.0 4.6

S - 15°

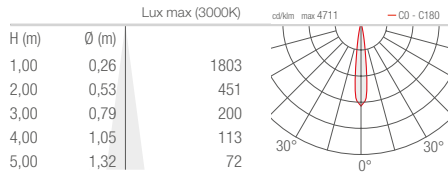

M - 22°

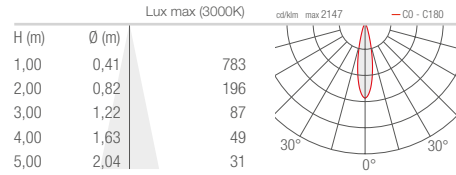

L - 54°

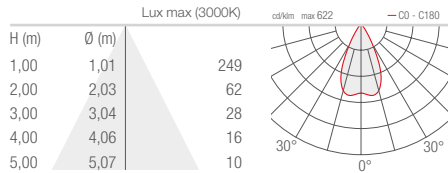

UPDOWN 6.0 7.0

S - 10°

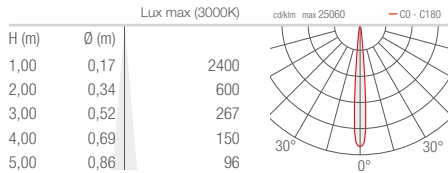

M - 20°

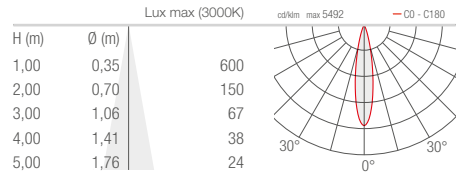

L - 40°

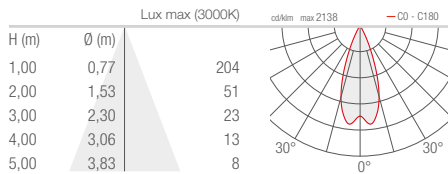

INDOOR WALL MOUNTED

VERSA 1.0

D - Diffuse

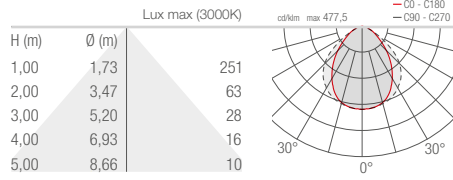

VERSA 2.0

D - Diffuse, down beam

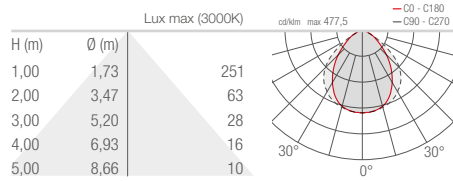

D - Diffuse, up beam

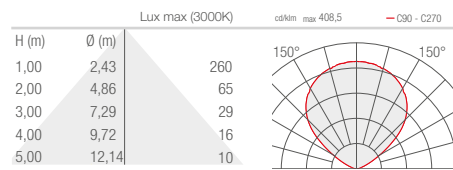

WALL

READING LAMPS

WALL 1 3

20° (20°–55°)

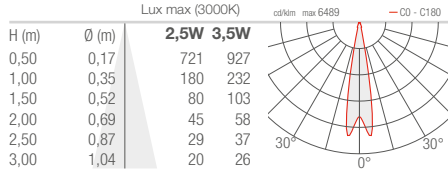

55° (20°–55°)

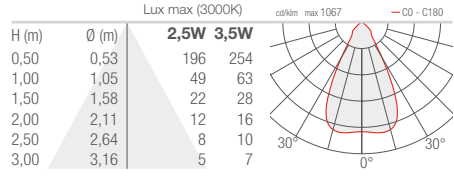

WALL 8.0

S - 10°

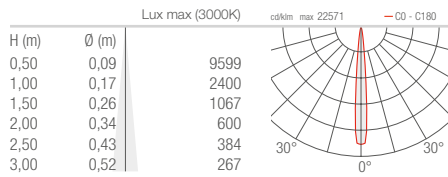

M - 25°

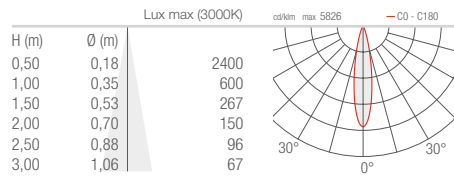

L - 40°

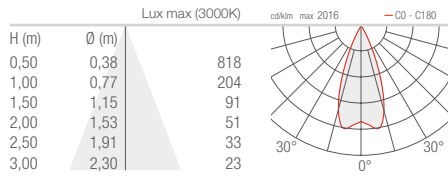

WALL 8.1 8.2

S - 10°

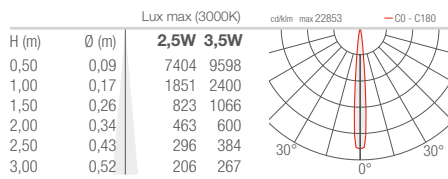

M - 25°

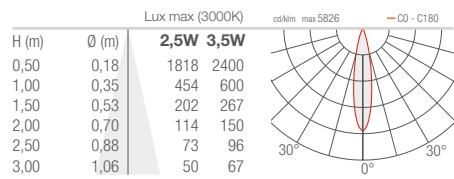

L - 40°

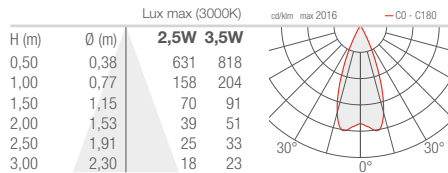





POWER SUPPLY UNITS AND CONTROL GEAR

TYPES OF LOW VOLTAGE CONNECTION

SERIES CONNECTIONS AND CONSTANT CURRENT POWER SUPPLY UNITS

A series connection consists of two or more components connected in such a way that they form a single path for the electric current flowing through them. In the case of lighting fixtures, a series connection means that the end of one device is connected to the end of the next. Power is supplied through free terminals on the first and last fixture.

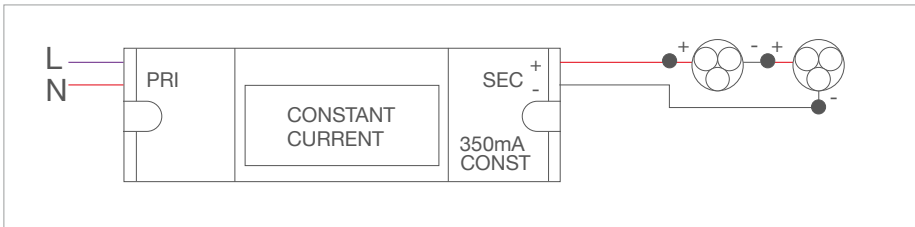

Wiring diagram of a series connection

Should you need to use a constant-current power supply unit (and thus a series connection in the case of multiple fixtures) you should consider the following:

- the maximum current that can be used to power the individual fixtures (220mA, 350mA, 500mA, 700mA, etc.);
- the maximum power required by all the fixtures making up the line.

Once you have checked the maximum permissible operating current, consider the maximum power absorbed by each fixture in the group and add it up (for example, two fixtures that absorb 5W each make a total of 10W): based on this information, and taking into consideration any particular control requirements (dimming), you can select a suitable power supply unit from those listed in the 350/500/700/1050mA LED power supply tables, making sure you check the correspondence with the minimum and maximum power they can deliver (and considering a 5–10% discrepancy). Be sure to always check that the power supply unit's electrical output specifications correspond to the fixture's requirements, to ensure correct operation.

WARNING:

Do not connect switches to the secondary circuit.
The system must be powered only after all the lighting fixtures have been connected.

PARALLEL CONNECTIONS AND CONSTANT VOLTAGE POWER SUPPLY UNITS

It is a parallel connection when lighting fixtures are connected to a pair of conductors so that the electrical voltage is applied to all of them equally. The fixtures are independent of each other: if one fails, the others will continue to work.

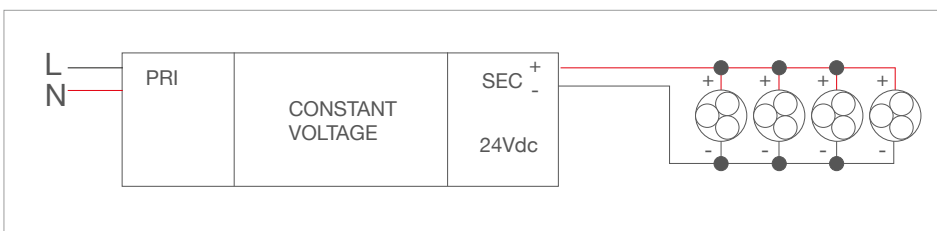

Wiring diagram of a parallel connection

Should you need to use a constant-voltage power supply unit (and thus a parallel connection in the case of multiple fixtures), we suggest you proceed as follows:

- consider the maximum power absorbed by each individual fixture (for example, 10W);
- check the voltage at which the fixture needs to be powered (12Vdc, 24Vdc, etc.);
- consider the total number of appliances to be connected and calculate the total power (for example, if there are five 10W fixtures, you will need $5 \times 10W = 50W$);
- add a margin of 20% to the power needed to supply the LED lighting system (for example, if there are five 10W fixtures, you will need $50W + 20\% = 60W$).

Using this information, you will be able to select the power supply unit that best fits your needs from the ones given in the tables of AC/DC switched-mode power supply units.

CAUTION:

The system must be powered only after all the light fixtures have been connected.



POWER SUPPLY UNITS AND CONTROL GEAR

HOW TO SELECT A POWER SUPPLY UNIT

To understand which type of power supply unit to use, you need to check the electrical specifications of the lighting fixture.

Constant current (possible values: 220mA, 350mA, 500mA, 700mA, 1050mA)

The connection between the lighting fixtures is in series: choose a power supply unit with constant current output that provides an adequate operating power range according to the total power to be installed (see page 906).

Example: Bright 1.0
reference values: max 2W, max 500mA

CODE	INput	OUTput	Max no. fixtures
A15500QL power supply in on/off current	115Vac - 230Vac 50Hz - 60Hz	500mA constant max 12W	6
A13500TC power supply in on/off current	115Vac - 230Vac 50Hz - 60Hz 230Vac 50Hz - 60Hz	500mA constant max 6W	3

Power supply for LEDs with output in constant current max 500mA.

Constant voltage (possible values: 12Vdc, 24Vdc, 48Vdc)

The connection between lighting fixtures is in parallel: choose a power supply unit with constant voltage output that provides an adequate operating power range according to the total power to be installed, considering an operating margin of 5–10% (see page 908).

Example: Ginko 2.4
reference values: 7W, 24Vdc

CODE	INput	OUTput	Max no. fixtures
AV24060IP20 power supply in on/off voltage	230Vac 50Hz - 60Hz	24Vdc 60W	7
AV24020IP67 power supply in on/off voltage	115Vac - 230Vac 50Hz - 60Hz 230Vac 50Hz - 60Hz	24Vdc 20W	2

POWER SUPPLY UNITS

UNIVERSAL POWER SUPPLY UNITS THAT CAN BE SET FOR LEDS

The electronic multi-current/multi-voltage power supply unit has DIP switches, components inside the power supply that are used to set the output voltage/current. This type of power supply unit is recommended for installations where you need to be able to adjust the system's lighting level, so that it can be adapted to the different light conditions.

It is very versatile and can also be utilised as a generic power supply: this makes it ideal for different applications.

CODE	Power	INput	OUTput	Dimensions		IP
A19220TC	max 15W	115Vac - 230Vac 50Hz - 60Hz	60-360mA	19x34x115 mm 65 g	Ø40 mm	IP20
ACUNIO32T1	12Vdc; 10W 24Vdc; 20W 28Vdc; 22W 350mA; max 17W 500mA; max 24W 550mA; max 25W 700mA; max 32W	115Vac - 230Vac 50Hz - 60Hz	12Vdc; 10W 24Vdc; 20W 28Vdc; 22W 350mA; max 17W 500mA; max 24W 550mA; max 25W 700mA; max 32W	34x46x166 mm 185 g	Ø56 mm	IP20
ACUNIO20T1	24Vdc; 16W 250mA; max 13W 350mA; max 19W 400mA; max 20W 450mA; max 20W 500mA; max 20W 550mA; max 20W 600mA; max 20W 700mA; max 20W	230Vac 50Hz - 60Hz	24Vdc; 16W 250mA; max 13W 350mA; max 19W 400mA; max 20W 450mA; max 20W 500mA; max 20W 550mA; max 20W 600mA; max 20W 700mA; max 20W	110x52x22 mm 185 g	Ø55 mm	IP20
ACUNIC30T1	250mA; max 13W 280mA; max 15W 310mA; max 16.5W 340mA; max 18W 370mA; max 19.5W 400mA; max 21W 430mA; max 22.5W 460mA; max 24W 490mA; max 26W 520mA; max 27.5W 550mA; max 29W 580mA; max 30W 610mA; max 30W 640mA; max 30W 670mA; max 30W 700mA; max 30W	230Vac 50Hz - 60Hz	250mA; max 13W 280mA; max 15W 310mA; max 16.5W 340mA; max 18W 370mA; max 19.5W 400mA; max 21W 430mA; max 22.5W 460mA; max 24W 490mA; max 26W 520mA; max 27.5W 550mA; max 29W 580mA; max 30W 610mA; max 30W 640mA; max 30W 670mA; max 30W 700mA; max 30W	180x30x21 mm 110 g	Ø38 mm	IP20
ACUNIO39T1	1050mA; max 39W 350mA; max 15W 500mA; max 21W 550mA; max 23W 650mA; max 27W 700mA; max 29W 750mA; max 31W 850mA; max 35W 900mA; max 37W	230Vac 50Hz - 60Hz	1050mA; max 39W 350mA; max 15W 500mA; max 21W 550mA; max 23W 650mA; max 27W 700mA; max 29W 750mA; max 31W 850mA; max 35W 900mA; max 37W	90x67x21 mm	Ø72 mm	IP20
ACUNIO42T1	1000mA; max 42W 1050mA; max 42W 300mA; max 13W 350mA; max 15W 400mA; max 18W 450mA; max 20W 500mA; max 22W 550mA; max 24W 600mA; max 27W 650mA; max 29W 700mA; max 31W 750mA; max 32W 800mA; max 33W 850mA; max 35W 900mA; max 38W 950mA; max 40W	230Vac 50Hz - 60Hz	1000mA; max 42W 1050mA; max 42W 300mA; max 13W 350mA; max 15W 400mA; max 18W 450mA; max 20W 500mA; max 22W 550mA; max 24W 600mA; max 27W 650mA; max 29W 700mA; max 31W 750mA; max 32W 800mA; max 33W 850mA; max 35W 900mA; max 38W 950mA; max 40W	30x43x147 mm 122g	Ø54 mm	IP20



POWER SUPPLY FOR 350mA LEDs – ON/OFF

CODE	Power	INput	OUTput	Dimensions		IP
ACUNIO20T1	19W	230Vac 50Hz - 60Hz	350mA 57Vdc max	110x52x22 mm 185 g	Ø55 mm	IP20
A13350VL	4W	115Vac - 230Vac 50Hz - 60Hz	350mA 12Vdc max	21x35x60 mm	Ø41 mm	IP20
A19350QL	15W	115Vac - 230Vac 50Hz - 60Hz	350mA 36Vdc max	116x33x19 mm	Ø39 mm	IP20
A312350QL	17W	115Vac - 230Vac 50Hz - 60Hz	350mA 48Vdc max	111x38x28 mm	Ø48 mm	IP20
ACUNIC30T1	18W	230Vac 50Hz - 60Hz	350mA	180x30x21 mm 110 g	Ø38 mm	IP20
ACUNIO39T1	15W	230Vac 50Hz - 60Hz	350mA 42Vdc max	90x67x21 mm	Ø72 mm	IP20
A16350IP67	11W	115Vac - 230Vac 50Hz - 60Hz	350mA 24Vdc max	Ø40x118 mm	Ø46 mm	IP67
A312350IP67	17W	115Vac - 230Vac 50Hz - 60Hz	350mA 48Vdc max	Ø45x118 mm	Ø46 mm	IP67

POWER SUPPLY FOR 500mA LEDs – ON/OFF

CODE	Power	INput	OUTput	Dimensions		IP
ACUNIO20T1	20W	230Vac 50Hz - 60Hz	500mA 40Vdc max	110x52x22 mm 185 g	Ø55 mm	IP20
A13500TC	6W	115Vac - 230Vac 50Hz - 60Hz	500mA 12Vdc max	68x35x21 mm	Ø41 mm	IP20
A15500QL	12W	115Vac - 230Vac 50Hz - 60Hz	500mA 24Vdc max	115x34x19 mm	Ø39 mm	IP20
A310500QL	20W	115Vac - 230Vac 50Hz - 60Hz	500mA 45Vdc max	111x38x28 mm	Ø48 mm	IP20
ACUNIC30T1	26W	230Vac 50Hz - 60Hz	490mA	180x30x21 mm 110 g	Ø38 mm	IP20
ACUNIO39T1	21W	230Vac 50Hz - 60Hz	500mA 42Vdc max	90x67x21 mm	Ø72 mm	IP20
A14500IP67	12W	115Vac - 230Vac 50Hz - 60Hz	500mA 24Vdc max	Ø40x95 mm	Ø45 mm	IP67
A310500IP67	20W	115Vac - 230Vac 50Hz - 60Hz	500mA 45Vdc max	Ø45x118 mm	Ø46 mm	IP67

POWER SUPPLY FOR 700mA LEDs – ON/OFF

CODE	Power	INput	OUTput	Dimensions		IP
ACUNIO20T1	20W	230Vac 50Hz - 60Hz	700mA 28Vdc max	110x52x22 mm 185 g	Ø55 mm	IP20
A13700QL	12W	115Vac - 230Vac 50Hz - 60Hz	700mA 18Vdc max	115x34x19 mm	Ø39 mm	IP20
ACUNIC30T1	30W	230Vac 50Hz - 60Hz	700mA	180x30x21 mm 110 g	Ø38 mm	IP20
ACUNIO39T1	29W	230Vac 50Hz - 60Hz	700mA 42Vdc max	90x67x21 mm	Ø72 mm	IP20
A13700IP67	12W	115Vac - 230Vac 50Hz - 60Hz	700mA 18Vdc max	Ø40x118 mm	Ø41 mm	IP67
A39700IP67	20W	115Vac - 230Vac 50Hz - 60Hz	700mA 45Vdc max	Ø45x120 mm	Ø46 mm	IP67

POWER SUPPLY FOR 1050mA LEDs – ON/OFF

CODE	Power	INput	OUTput	Dimensions		IP
ACUNIO39T1	39W	230Vac 50Hz - 60Hz	1050mA 42Vdc max	90x67x21 mm	Ø72 mm	IP20

POWER SUPPLY UNITS

12Vdc

CODE	INput	Power	Dimensions		IP
AV12020IP20	115Vac - 230Vac 50Hz - 60Hz	20W	146x55x19 mm	Ø60 mm	IP20
AV12040IP67	115Vac - 230Vac 50Hz - 60Hz	40W	163x43x32 mm	Ø55 mm	IP67
AV12060IP67	115Vac - 230Vac 50Hz - 60Hz	60W	163x43x32 mm	Ø55 mm	IP67
AV12150IP67	115Vac - 230Vac 50Hz - 60Hz	132W	222x68x39 mm	Ø79 mm	IP67
AV12192IP67	115Vac - 230Vac 50Hz - 60Hz	192W	244x68x39 mm	Ø79 mm	IP67

24Vdc

CODE	INput	Power	Dimensions		IP
AV24010IP20	115Vac - 230Vac 50Hz - 60Hz	10W	117x32x22 mm	Ø40 mm	IP20
AV24060IP20	230Vac 50Hz - 60Hz	60W	125x82x29 mm	Ø87 mm	IP20
AV24100IP20	230Vac 50Hz - 60Hz	100W	106x90x58 mm	DIN GUIDE	IP20
AV24150IP20	230Vac 50Hz - 60Hz	150W	280x40x29 mm	Ø49 mm	IP20
AV24008IP54	115Vac - 230Vac 50Hz - 60Hz	8W	46x44x27 mm	Ø52 mm	IP54
AV24020IP67	115Vac - 230Vac 50Hz - 60Hz	20W	118x35x26 mm	Ø45 mm	IP67
AV24040IP67	115Vac - 230Vac 50Hz - 60Hz	40W	163x43x32 mm	Ø55 mm	IP67
AV24060IP67	115Vac - 230Vac 50Hz - 60Hz	60W	163x43x32 mm	Ø55 mm	IP67
AV24150IP67	115Vac - 230Vac 50Hz - 60Hz	150W	222x68x39 mm	Ø79 mm	IP67
AV24240IP67	115Vac - 230Vac 50Hz - 60Hz	240W	245x68x39 mm	Ø79 mm	IP67
AV24320IP67	115Vac - 230Vac 50Hz - 60Hz	320W	252x90x44 mm	Ø101 mm	IP67











36Vdc

CODE	INput	Power	Dimensions		IP
AV36060IP67	115Vac - 230Vac 50Hz - 60Hz	60W	150x53x35 mm	Ø65 mm	IP67

48Vdc

CODE	INput	Power	Dimensions		IP
AV48150IP20	230Vac 50Hz - 60Hz	150W	240x60x49 mm	Ø70 mm	IP20
AV48060IP67	115Vac - 230Vac 50Hz - 60Hz	60W	163x43x32 mm	Ø55 mm	IP67
AV48150IP67	115Vac - 230Vac 50Hz - 60Hz	150W	222x68x39 mm	Ø79 mm	IP67
AV48240IP67	115Vac - 230Vac 50Hz - 60Hz	240W	245x68x39 mm	Ø79 mm	IP67

DIMMABLE POWER SUPPLY UNITS

CODE	Power	INput	Dimming	OUTput	Dimensions		IP	Sync
ADUNITC	12Vdc; 11W 24Vdc; 20W 250mA; 5W-13W 300mA; 5W-16W 350mA; max 18W 400mA; max 21W 450mA; max 23W 500mA; max 25W 550mA; max 27W 600mA; max 30W 650mA; max 32W 700mA; max 32W 750mA; max 20W 800mA; max 20W 850mA; max 20W 900mA; max 20W	115Vac - 230Vac 50Hz - 60Hz	PUSH 0/1-10V WX05	12Vdc; 11W 24Vdc; 20W 250mA; max 13W 300mA; max 16W 350mA; max 18W 400mA; max 21W 450mA; max 23W 500mA; max 25W 550mA; max 27W 600mA; max 30W 650mA; max 32W 700mA; max 32W 750mA; max 20W 800mA; max 20W 850mA; max 20W 900mA; max 20W	21x67x103 mm 120 g		IP20	Yes with cable (max 9 slaves) WX06 WX07
AD050PUSHT1	1050mA; max 50W 350mA; max 25W 500mA; max 35W 550mA; max 39W 650mA; max 46W 700mA; max 50W 750mA; max 50W 850mA; max 50W 900mA; max 50W	115Vac - 230Vac 50Hz - 60Hz	PUSH 0/1-10V WX05	1050mA; max 50W 350mA; max 25W 500mA; max 35W 550mA; max 39W 650mA; max 46W 700mA; max 50W 750mA; max 50W 850mA; max 50W 900mA; max 50W	22x79x124 mm 150 g		IP20	Yes with cable (max 9 slaves) WX06 WX07
AD030DALIT1 AD030DALIT1AM	250mA; max 13W 280mA; max 15W 310mA; max 17W 340mA; max 18W 370mA; max 20W 400mA; max 21W 430mA; max 23W 460mA; max 24W 490mA; max 26W 520mA; max 28W 550mA; max 29W 580mA; max 30W 610mA; max 30W 640mA; max 30W 670mA; max 30W 700mA; max 30W	115Vac - 230Vac 50Hz - 60Hz	PUSH DALI	250mA; max 13W 280mA; max 15W 310mA; max 17W 340mA; max 18W 370mA; max 20W 400mA; max 21W 430mA; max 23W 460mA; max 24W 490mA; max 26W 520mA; max 28W 550mA; max 29W 580mA; max 30W 610mA; max 30W 640mA; max 30W 670mA; max 30W 700mA; max 30W	217x30x21 mm 120 g		IP20	Yes
AD050DALIT1	1050mA; max 50W 350mA; max 25W 500mA; max 35W 550mA; max 39W 650mA; max 46W 700mA; max 50W 750mA; max 50W 850mA; max 50W 900mA; max 50W	115Vac - 230Vac 50Hz - 60Hz	PUSH 0/1-10V DALI WX05	1050mA; max 50W 350mA; max 25W 500mA; max 35W 550mA; max 39W 650mA; max 46W 700mA; max 50W 750mA; max 50W 850mA; max 50W 900mA; max 50W	22x79x124 mm 150 g		IP20	Yes with cable (max 9 slaves) WX06 WX07
AD020DALIT1	24Vdc; 16W 250mA; max 10W 350mA; max 15W 400mA; max 17W 450mA; max 19W 500mA; max 20W 550mA; max 20W 600mA; max 20W 700mA; max 20W	115Vac - 230Vac 50Hz - 60Hz	DALI	24Vdc; 16W 250mA; max 10W 350mA; max 15W 400mA; max 17W 450mA; max 19W 500mA; max 20W 550mA; max 20W 600mA; max 20W 700mA; max 20W	22x52x111 mm 108 g		IP20	No
AD032TLT1	12Vdc; 10W 24Vdc; 20W 28Vdc; 22W 350mA; max 17W 500mA; max 24W 550mA; max 25W 700mA; max 32W 750mA; max 32W	115Vac - 230Vac 50Hz - 60Hz	PUSH IGBT-TRIAC	12Vdc; 10W 24Vdc; 20W 28Vdc; 22W 350mA; max 17W 500mA; max 24W 550mA; max 25W 700mA; max 32W 750mA; max 32W	34x46x166 mm 185 g		IP20	Yes with cable (max 9 slaves) WX06 WX07
AD018350TLT1	8-18W	115Vac - 230Vac 50Hz - 60Hz	IGBT-TRIAC	350mA	22x52x111 mm 108 g		IP20	Yes
AD020500TLT1	8-20W	115Vac - 230Vac 50Hz - 60Hz	IGBT-TRIAC	500mA	22x52x111 mm 108 g		IP20	Yes
WX05	0/1-10V potentiometer							
WX06	Synchronization cable, L=1.5 m							
WX07	Synchronization cable, L=4 m							

Dimmable power supply units allow you to control the light intensity of lighting fixtures that are electrically compatible. Brightness is adjusted via various control inputs: PUSH (NO button), potentiometer (0/1–10V), 0/1–10V analogue signal, DALI digital signal or mains dimming. Universal (multi-voltage/multi-current) dimmable models are available with DIP switches to select output current/voltage.

DIMMING WITH NO BUTTON (PUSH)

NO (PUSH) button dimming is the simplest method: a short press switches the system on or off; a long press increases or decreases the light intensity.

Using the PUSH command, you can synchronize up to a maximum of 10 power supply units with a sync cable (1 master + 9 slaves). The maximum distance possible between a button and the master power supply unit is 15 m.

CAUTION:
Only use Normally Open (NO) buttons without built-in indicator light.

PUSH-controlled power supply units

ADUNITC

AD050PUSHT1

AD050DALIT1

AD032TLT1

AD030DALIT1

AD030DALIT1AM

WIRING DIAGRAMS FOR DIMMING WITH NO BUTTON (PUSH)

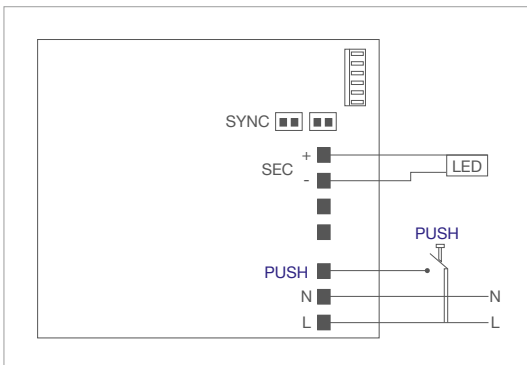

PUSH control with ADUNITC

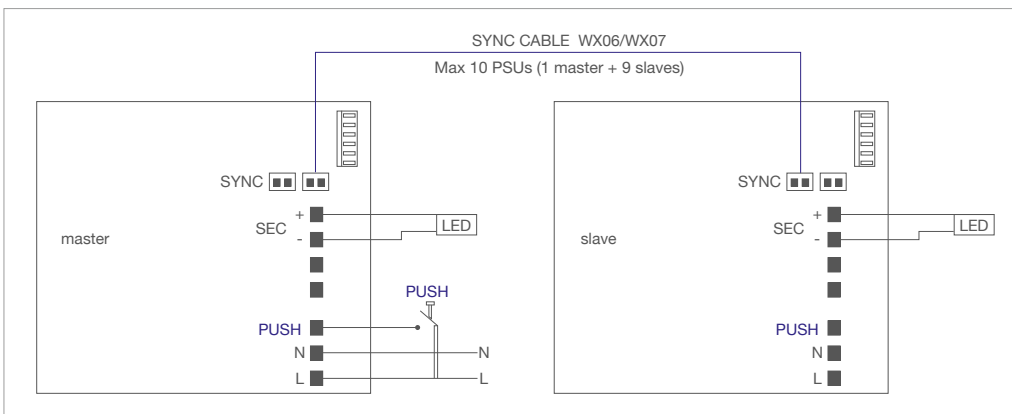

PUSH control with synchronization with ADUNITC

DIMMABLE POWER SUPPLY UNITS

DIMMING WITH 0/1-10V SIGNAL

Power supply units dimmable with 0/1-10V signal allow you to adjust the brightness from 0 to 100% using a 1-10V interface (100-kiloohm potentiometer) or a 0-10V analogue signal.

0-10V and 1-10V are similar protocols used for dimming light: both systems use a voltage level to communicate with the power supply unit.

A 10V voltage corresponds to the highest brightness level; lower voltage levels will correspond to lower brightness. With voltage levels below 0.5V, the product will switch off.

The reference standard for the 0-10V protocol is ANSI E1.3 Entertainment Technology – Lighting Control Systems. For the 1-10V protocol, the reference standard is IEC60929 (annex E).

The fundamental difference between the two control systems is the direction of the current between the dimmer and the power supply unit: for the 0-10V (active) system, the current is generated by the dimmer and then enters the power supply; voltages lower than 0.5V switch off the product. For the 1-10V (passive) system, the current enters the dimmer, which regulates passively; normally a switch must be added to switch off the fixture.

Power supply units with 0/1-10V control

ADUNITC

AD050PUSHT1

AD050DALIT1

WX05	0/1-10V potentiometer
------	-----------------------

WX06	Synchronization cable, L=1.5 m
------	--------------------------------

WX07	Synchronization cable, L=4 m
------	------------------------------

WIRING DIAGRAMS FOR DIMMING WITH 0/1-10V SIGNAL

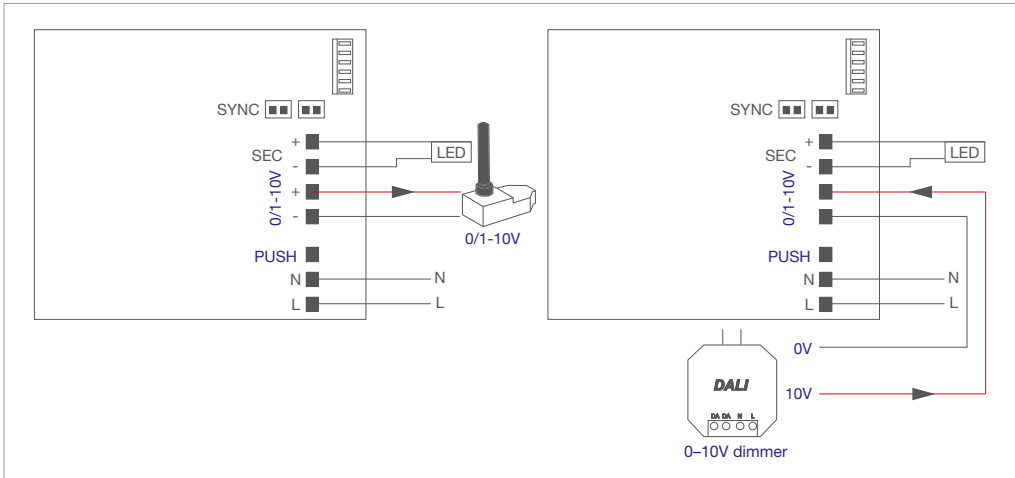

0/1-10V control

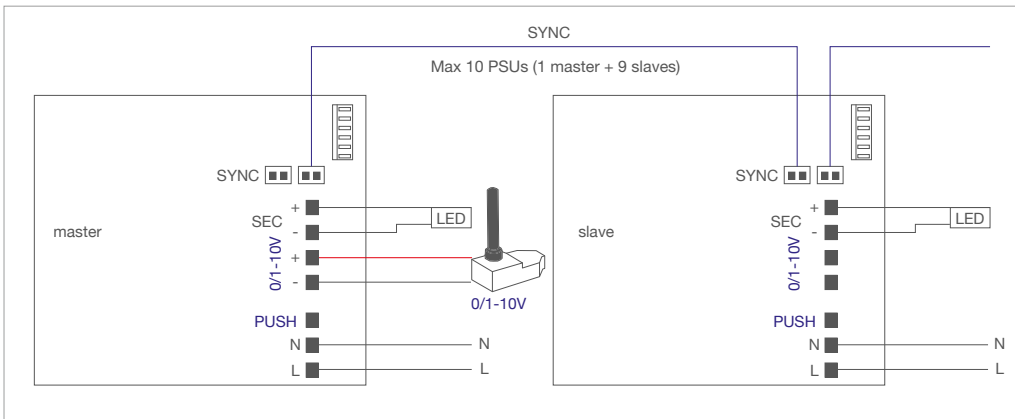

0/1-10V control with synchronization with ADUNITC

DIMMABLE POWER SUPPLY UNITS

DIMMING WITH DALI BUS

DALI (Digital Addressable Lighting Interface) is a digital lighting protocol mainly used for ambient lighting in larger buildings, such as offices, museums and hospitals.

It is a very flexible system that can control both simple systems with a single fixture and advanced systems with several groups of fixtures. There is a free choice of connection (parallel, star, series, etc.); the signal is transmitted via two ordinary cables, and there are no polarities. A maximum of 64 devices can be controlled by the same controller.

The DALI protocol is used when it is necessary to be able to set different light groups at different brightness levels.

It is a two-way system: the controlled lighting group provides feedback on its status, such as the brightness level, to the DALI master controller. This two-way communication can also be used to signal malfunctions.

DALI-controlled power supply units

AD020DALIT1

AD030DALIT1

AD050DALIT1

AD030DALIT1AM

WIRING DIAGRAMS FOR DIMMING WITH DALI BUS

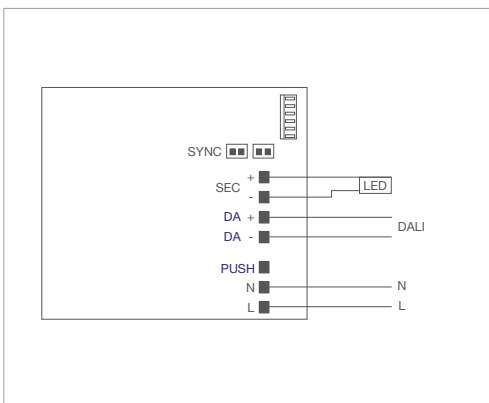

DALI control with AD050DALIT1

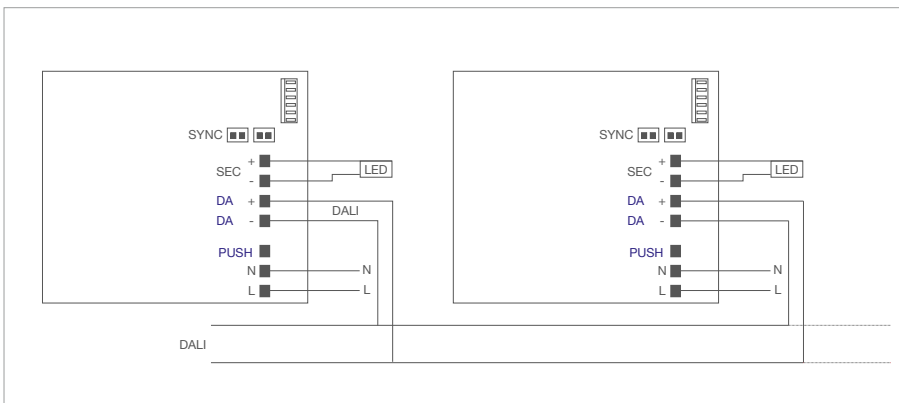

DALI control / Max 64 DALI devices with AD050DALIT1

DIMMING WITH MAINS DIMMING (IGBT - TRIAC)

Mains dimmers are light controllers that vary the lighting fixture's supply voltage by means of an electronic circuit. LED lighting fixtures require trailing edge dimmers.

Power supply units with mains dimming

AD032TLT1

AD018350TLT1

AD020500TLT1

WIRING DIAGRAMS FOR DIMMING WITH MAINS DIMMING (IGBT - TRIAC)

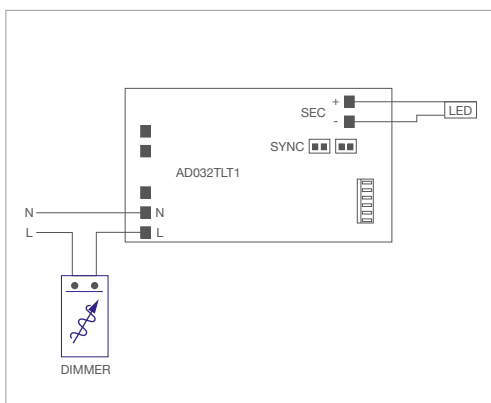

Control (IGBT - TRIAC)

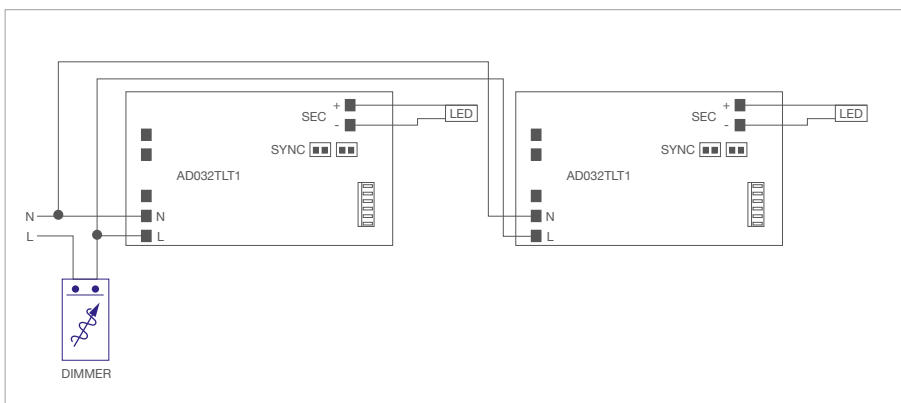

Control (IGBT - TRIAC)

CONTROL SYSTEMS

LOW-VOLTAGE DIMMERS

Low-voltage dimmers are a solution for controlling constant-voltage LEDs via different types of input:

- Normally Open (NO) button;
- 0/1–10V analogue signal;
- 0/1–10V potentiometer;
- DALI digital signal.

The power supply voltage varies from 12 to 48Vdc, while the output voltage is equal to the input voltage and allows you to control a load up to a maximum current value of 12A. The intensity curve and the soft fade on and off have been designed to ensure maximum visual comfort by matching the behaviour of the human eye. The device can be synchronized with slaves (using DIP switch settings).

CODE	INput	OUTput	OUTput POWER min-max	Dimensions	IP
ADV576DALIN1	12Vdc 24Vdc 48Vdc	$V_{in}=V_{out}$ (12A max)	0–144W (12Vdc) 0–288W (24Vdc) 0–576W (48Vdc)	100x40x25 mm 40 g	Ø48 mm IP20

This system can be used with a remote control (see TLR07, TLC15, TLC16, TLC17 on page 921).

WIRING DIAGRAMS FOR LOW-VOLTAGE DIMMING

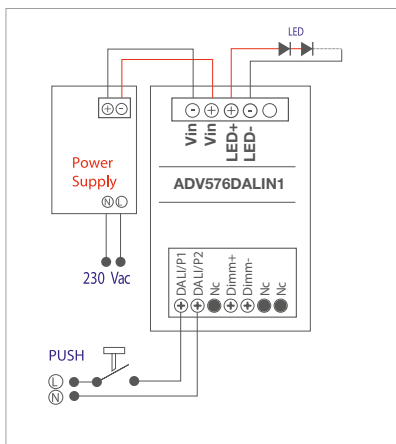

PUSH control

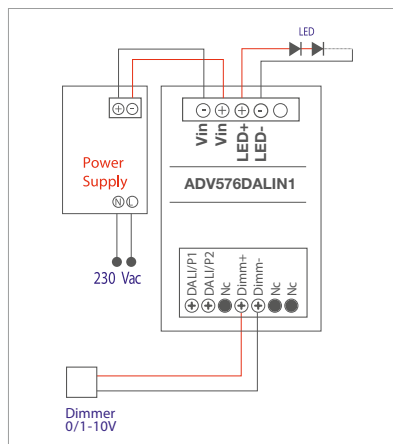

0/1–10V control

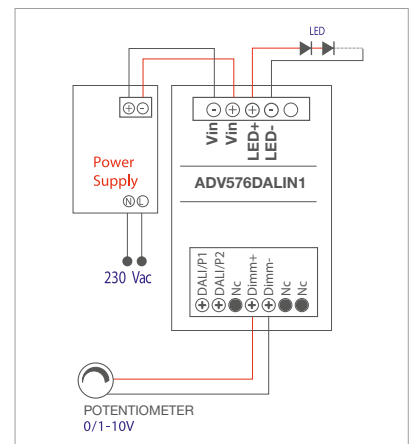

Control with 0/1–10V potentiometer

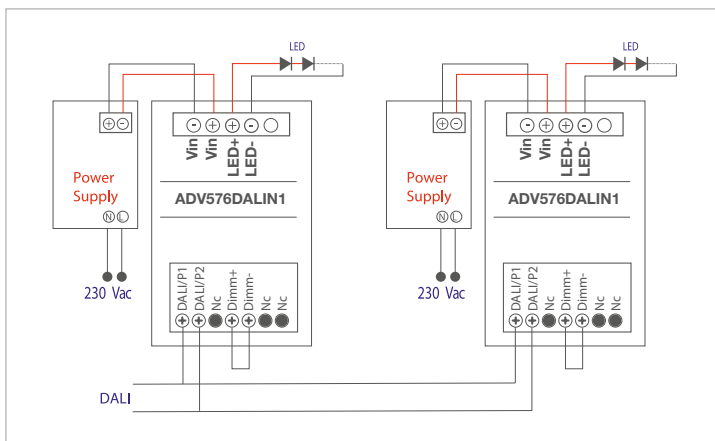

DALI control

LOW-VOLTAGE SEQUENCERS

Low-voltage sequencers are a solution for controlling multicolour fixtures via different types of input:

- Normally Open (NO) button;
- 0/1–10V analogue signal;
- 0/1–10V potentiometer;
- DALI digital signal;
- DMX512 digital signal.

EASY RGB MULTICHANNEL SEQUENCER

Easy RGB Push is an RGB sequencer with three output channels that enables you to control LED RGB devices in current or voltage to dynamically change their colour. The device allows you to adjust the colour tone and rotation speed of the RGB cycle using a Normally Open (NO) button. The optimized adjustment curve produces a soft colour fade, ensuring maximum visual comfort.

The supply voltage varies from 12Vdc to 48Vdc. The device is equipped with systems that protect it from:

- overtemperature;
- overpowering;
- underpowering;
- power supply polarity reversal;
- output short circuit.

It also has an output current limiter.

CODE	RGB power min-max	INput	OUTput	Dimensions	Ø	IP
ARC336350D1	3–12.5W 3–25W 3–50W	12Vdc 24Vdc 48Vdc	350mA/3ch	25x44x44 mm 20 g	Ø52 mm	IP20
ARC336500D1	3–18W 3–36W 3–72W	12Vdc 24Vdc 48Vdc	500mA/3ch	25x44x44 mm 20 g	Ø52 mm	IP20
ARC336700D1	3–25W 3–50W 3–100W	12Vdc 24Vdc 48Vdc	700mA/3ch	25x44x44 mm 20 g	Ø52 mm	IP20
ARV230PD1		12Vdc 24Vdc 48Vdc	1–90W 1–180W 1–360W	25x44x44 mm 20 g	Ø52 mm	IP20

OPERATION:

Push button	Function
Click	On/Off
A long press (>1sec) when switched off	Change in rotation speed*
A long press (>1sec) when switched on	Start/Stop colour rotation

This system can be used with a remote control (see TLR07, TLC15, TLC16, TLC17 on page 921).

* The colour rotation speed can be adjusted to 4 levels.

The selected speed is displayed with a white flashing light:

- 10 flashes/sec for a 6-second rotation
- 5 flashes/sec for a 30-second rotation
- 2 flashes/sec for a 6-minute rotation
- 1 flash/sec for a 30-minute rotation

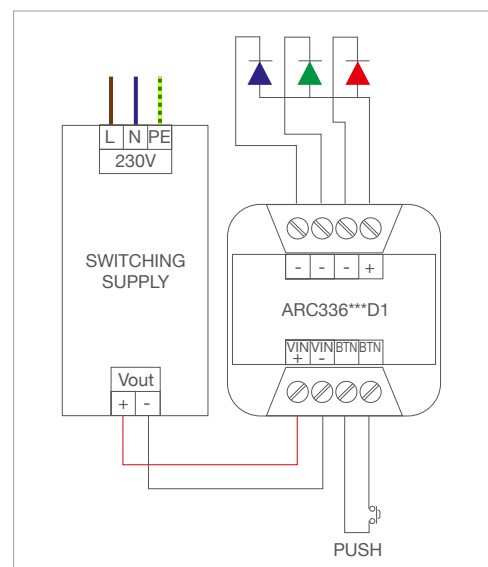

CONTROL SYSTEMS

HOME RGB MULTICHANNEL SEQUENCER

The Home RGB device is designed to power, steer and control LED lighting fixtures with RGB technology. The driver has outputs to drive current-controlled LED lighting fixtures at 350mA or 500mA.

To execute dynamic colour change sequences, the device has a stand-alone mode that, with the Easy-Run-Menu function, allows you to choose one of the pre-set sequences stored in the device, and to reproduce it at a speed you select.

The device can be connected to a remote-control button to manually activate the selected sequence and synchronize it with other units without any control connection between the various devices.

Thanks to its DMX512-protocol-compatible interface, it is possible to control the device through an external DMX control unit or recorder.

CODE	R-G-B power min-max	INput	OUTput	Dimensions		IP
AR330350TC	3-36W	230Vac 50Hz - 60Hz	350mA	36x60x225 mm 240 g	Ø72 mm	IP20
AR330500TC	3-36W	230Vac 50Hz - 60Hz	500mA	36x60x225 mm 240 g	Ø72 mm	IP20

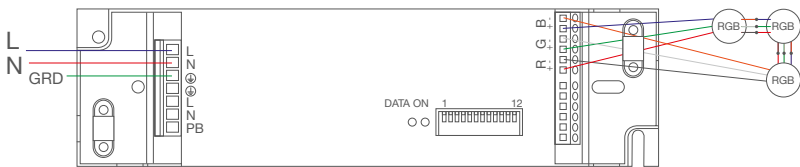

Stand-alone

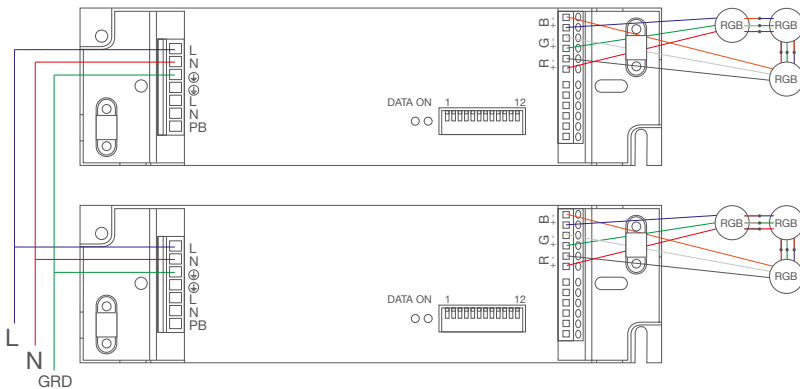

Stand-alone with synchronization

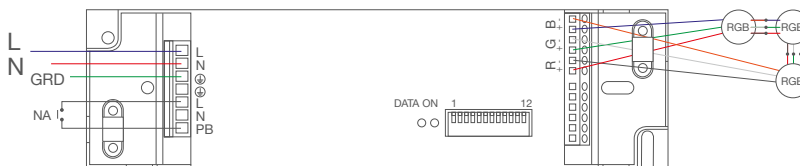

With external button

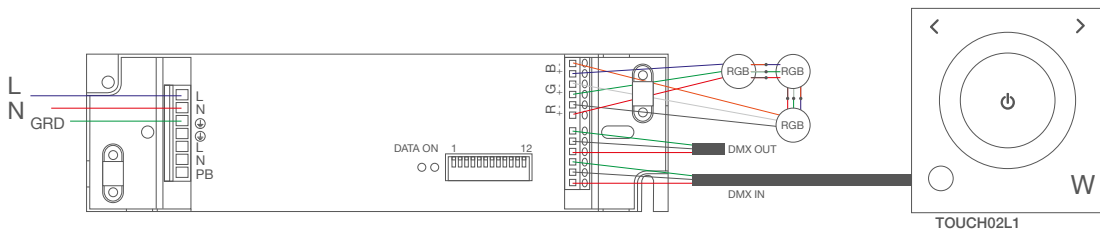

With DMX512

UNIVERSAL MULTICHANNEL SEQUENCER

A universal sequencer is a four-channel (RGBW) LED controller that controls the lighting fixtures in both constant current and constant voltage.

This device is suitable for mounting in switchboards on DIN rails.

It operates in DMX (RDM), DALI, 0/1–10V, 1–9V, 10-kilohm potentiometer, push button and “stand-alone” modes with 20 stored shows.

The supply voltage for this module ranges from 12Vdc to 48Vdc; dimming is by PWM (2.9 kHz).

The ARCUNID2-01 constant current output version allows the output current to be selected via a rotary switch and can be used to supply all LED types from 250mA up to 1050mA (Vf max 43Vdc).

LEDs can be connected in series, up to a maximum of 180W (4 channels; 1050mA; 48Vdc).

The ARVUNID2-01 constant voltage output version allows LED modules to be operated in voltage up to a maximum of 768Vdc (4 channels at 48Vdc).

In both the current and the voltage version, the controller can be operated as:

- single- or synchronized-channel dimmer;
- RGB/RGBW sequencer;
- 2-channel dynamic white controller;
- stand-alone (multi-programming, 20 programs);
- stand-alone.

CODE	INput	INput command	OUTput	OUTput POWER 3 ch (RGB)	OUTput POWER 4 ch (RGBW)	Dimensions	IP
ARCUNID2-01	12Vdc-48Vdc	PUSH (3NA) PUSH 20 show Stand-alone 0/1–10V / 1–9V 10kΩ potentiometer DMX512 + RDM DALI	(Vout=Vin-5) 250 350mA const 500mA const 700mA const 1050	12V 24V 48V 7.3W 20W 45W 10.5W 28.5W 64.5W 14.6W 40W 90.3W	12V 24V 48V 9.8W 26.6W 60.2W 14W 38W 86W 19.6W 53.2W 120.4W	90x72x60 mm	IP20
ARVUNID2-01	12Vdc-48Vdc	PUSH (3NA) PUSH 20 show Stand-alone 0/1–10V / 1–9V 10kΩ potentiometer DMX512 + RDM DALI	(Vout=Vin) max 5A/ch (@3Ch) max 4A/ch (@4Ch)	max 180W (12Vdc) max 360W (24Vdc) max 720W (48Vdc)	max 192W (12Vdc) max 384W (24Vdc) max 768W (48Vdc)	90x72x60 mm	IP20

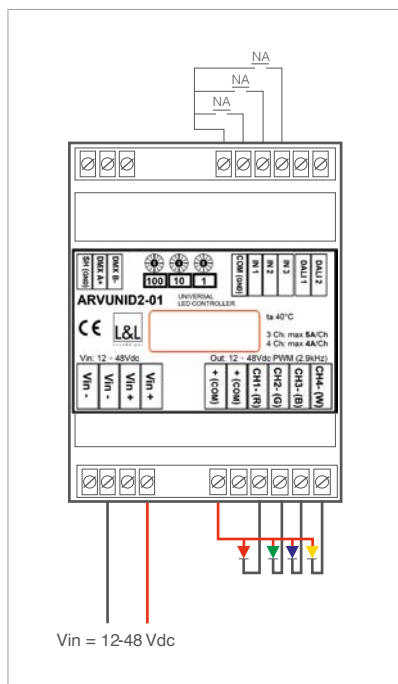

Push button control

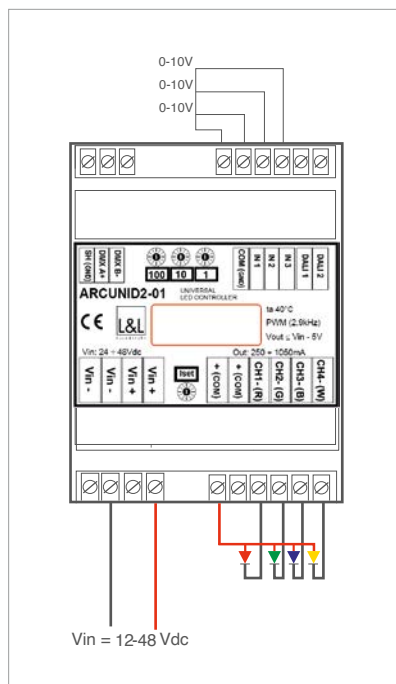

Control using 0–10V

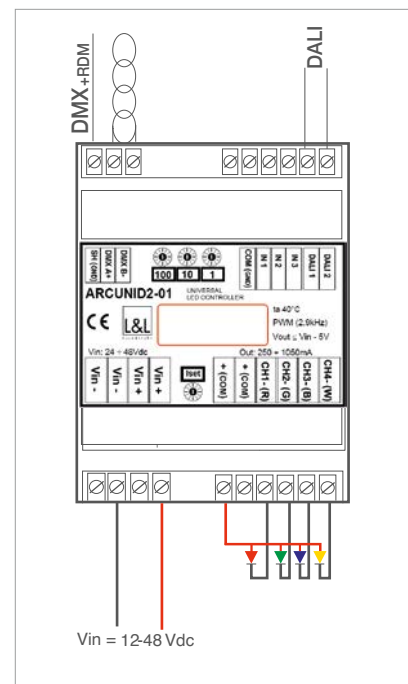

Control using DALI or DMX512 bus

CONTROL SYSTEMS

RADIO FREQUENCY MULTICHANNEL SEQUENCER

Radio frequency (RF) multichannel sequencers are four-channel controllers (dynamic white, RGB and RGBW) that allow lighting fixtures to be controlled in both constant current and constant voltage. These devices interface with touch panels via a 2.4GHz radio signal. The power supply of these modules is constant-voltage low voltage, and dimming is by PWM.

The ECCTS1284CC20 constant current output version allows the output current to be selected via a switch and can be used to power all 350mA, 700mA and 1050mA LED types (Vf max 46Vdc).

The ECCTS5244CV20 constant voltage output version allows LED modules to be operated in voltage up to a maximum of 480W (4 channels at 24Vdc).

The ECCTR1244CV20 constant voltage output version allows LED modules to be operated in voltage up to a maximum of 384W (4 channels at 24Vdc).

This device can connect via Wi-Fi to a home router and allows devices connected to it to be controlled via the Wi-Fi106 app (single-channel dimmer, 2Ch/3Ch dynamic white, RGB, RGBW).

In both the current and the voltage version, the controller can be operated in the following ways:

- TOUCH02L1 single-zone radio frequency panel;
- TOUCH03L1 4-zone radio frequency panel with memory;
- ECPNL2301DM20 4-zone radio frequency panel;
- Wi-Fi106 app and ECCTR1244CV20

CODE	INput	INput command Radio frequency	OUTput (Vout=3-46V)	OUTput POWER 3 ch (RGB)			OUTput POWER 4 ch (RGBW)			Dimensions	IP
				12V	24V	48V	12V	24V	48V		
ECCTS1284CC20	12Vdc - 48Vdc	TOUCH02L1	350mA cost	12V	24V	48V	12V	24V	48V	30x44x175 mm	IP20
		TOUCH03L1	700mA cost	10.5W	23W	48.3W	14W	31W	64.4W		
		ECPNL2301DM20	1050mA cost	21W	46W	96.6W	28W	62W	128.5W		
		ECCTR1244CV20 (Wi-Fi106)		31.5W	69W	145W	42W	93W	193W		
ECCTS5244CV20	5Vdc - 24Vdc	TOUCH02L1	(Vout=Vin) max 5A/ch	max 180W (12Vdc)			max 240W (12Vdc)			30x44x175 mm	IP20
		TOUCH03L1		max 360W (24Vdc)			max 480W (24Vdc)				
		ECPNL2301DM20									
		ECCTR1244CV20 (Wi-Fi106)									
ECCTR1244CV20	12Vdc - 24Vdc	TOUCH02L1	(Vout=Vin) max 4A/ch	max 144W (12Vdc)			max 192W (12Vdc)			45x73x128 mm	IP20
		TOUCH03L1		max 288W (24Vdc)			max 384W (24Vdc)				
		ECPNL2301DM20									
		APP Wi-Fi106									

CONTROL SYSTEMS

INPUT VIA REMOTE CONTROL KIT (PUSH)

All the L&L light control devices that can be controlled with NO buttons (PUSH function) can have a radio control kit assigned to them: the kit consists of a 2-channel receiver and three types of touch-button remote control for transmitting the control pulses: TLC15 (1 zone), TLC16 (2 zones), TLC17 (4 zones).

CODE	INput	Range	OUTput	Dimensions	IP
TLR02-01 Controller with integrated 4-channel receiver for RGB/RGBW/dynamic white/dimming RGB/RGBW: Required TLC08 or TLC09 remote control, not included Dynamic white/dimming: PUSH switch	12Vdc - 24Vdc	100m (30m indoors)	2.5 A/ch 4 ch (120W/240W)	80x80x16 mm	IP20
TLR03 Cyan colour controller with integrated 2-channel receiver Required TLC10 remote control, not included	12Vdc - 24Vdc	100m (30m indoors)	4 A/ch 2 ch (96W/192W)	58x43x21 mm	IP20
TLR07 2-channel receiver Required TLC15, TLC16 or TLC17 remote control, not included	230Vac	100m (30m indoors)	2 relay contacts	58x43x21 mm	IP20
TLR04M-350-500 RGB controller with integrated 3-channel receiver Required TLC08 or TLC09 remote control, not included	12Vdc - 24Vdc - 36Vdc	100m (30m indoors)	350mA 500mA	174x46x35 mm	IP20
TLR04M-350-700 RGB controller with integrated 3-channel receiver Required TLC08 or TLC09 remote control, not included	12Vdc - 24Vdc - 36Vdc	100m (30m indoors)	350mA 700mA	174x46x35 mm	IP20
TLR05S-350 3-channel extender, slave	12Vdc - 24Vdc - 36Vdc		700mA	174x46x35 mm	IP20
TLR05S-500 3-channel extender, slave	12Vdc - 24Vdc - 36Vdc		500mA	174x46x35 mm	IP20
TLC08 Remote control for controller TLR02-01, TLR04M-350-500, TLR04M-350-700	CR2450 battery	100m (40m indoors)	433.92 MHz	40x40x10 mm	IP20
TLC09 Remote control for controller TLR02-01, TLR04M-350-500, TLR04M-350-700	CR2450 battery	100m (40m indoors)	433.92 MHz	40x40x10 mm	IP20
TLC10 Remote control for controller TLR03	CR2450 battery	100m (40m indoors)	433.92 MHz	40x40x10 mm	IP20
TLC15 1-channel remote control for TLR07	CR2450 battery	100m (40m indoors)	433.92 MHz	40x40x10 mm	IP20
TLC16 2-channel remote control for TLR07	CR2450 battery	100m (40m indoors)	433.92 MHz	40x40x10 mm	IP20
TLC17 4-channel remote control for TLR07	CR2450 battery	100m (40m indoors)	433.92 MHz	40x40x10 mm	IP20
ECCTS5241DM20 RF/DMX receiver/converter	12Vdc - 24Vdc	100m (30m indoors)	2.4 GHz	65x65x26 mm	IP20

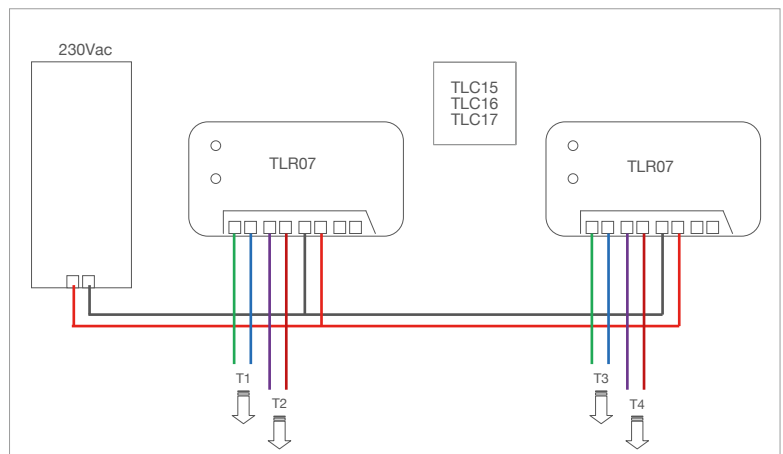
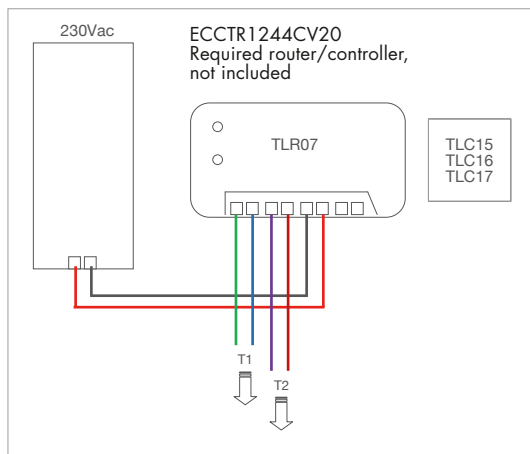

CONTROL SYSTEMS

INPUT VIA TOUCH02L1 / TOUCH03L1 / ECPNL2301DM20 (DMX512 OR RF PROTOCOL)

The TOUCH02L1/TOUCH03L1/ECPNL2301DM20 panels are touchscreen control devices that can generate a DMX512 bus signal on 1 area, 4 areas or on a radio frequency signal (2.4 GHz) to control dynamic white/RGB/RGBW lighting fixtures when combined with a controller connected to the DMX512 bus (e.g. ARCUNID2-01 or ARVUNID2-01) or to a radio frequency signal (for example ECCTS1284CC20, ECCTS5244CV20, ECCTR1244CV20). The screen can be used to control cycle times, light intensity and colours. It also has an icon with which it is possible to call up 7 static colours and 4 sequences. The panels can be used with all L&L devices compatible with the DMX512 protocol. Installation requires a WC0302 recessed box.

CODE	INput	Control	OUTput	Zones controlled	Dimensions	IP
TOUCH02L1	100Vac - 240Vac	touch RGB/RGBW	DMX512 bus	1 zone	86x86x36 mm 225 g	IP20
TOUCH03L1	100Vac - 240Vac	touch RGB/RGBW	DMX512 bus	4 zones with memories	86x86x36 mm 225 g	IP20
ECPNL2301DM20	100Vac - 240Vac	touch RGB/RGBW	DMX512 bus	4 zones	86x86x36 mm 225 g	IP20

WC0302
Outer casing for touchscreen device

90x90x50 mm

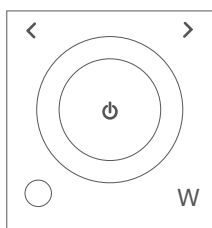

TOUCH02L1

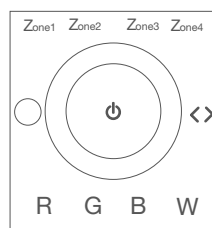

TOUCH03L1

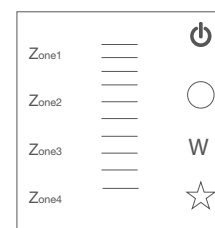

ECPNL2301DM20

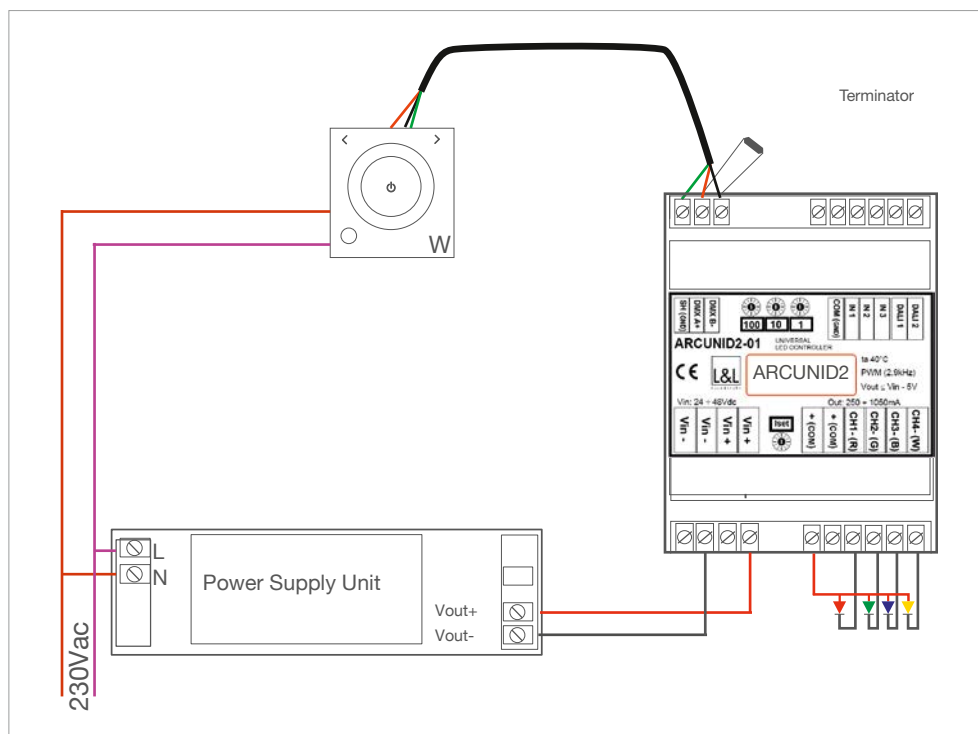

CONTROL SYSTEMS

INPUT VIA DMX01 (DMX512 PROTOCOL)

DMX01 is a controller, programmable via software, that communicates with the devices connected to it via a DMX512 type control bus. The programming software comes with the controller, and the programs are stored inside the unit itself: you can program up to 99 shows. You can use the buttons on the controller to call up the various stored light shows without the need for a PC connection. You can also manage the connected devices dynamically and in real time by interacting with the software interface. Using a connector for the I/O port, you can set up a series of Normally Open (NO) buttons to call up the stored scenes (up to a maximum of 255 scenes).

CODE	INput	OUTput	Dimensions	IP
DMX01	230Vac (adaptor)	DMX512 bus	79x92x43 mm 120 g	IP20

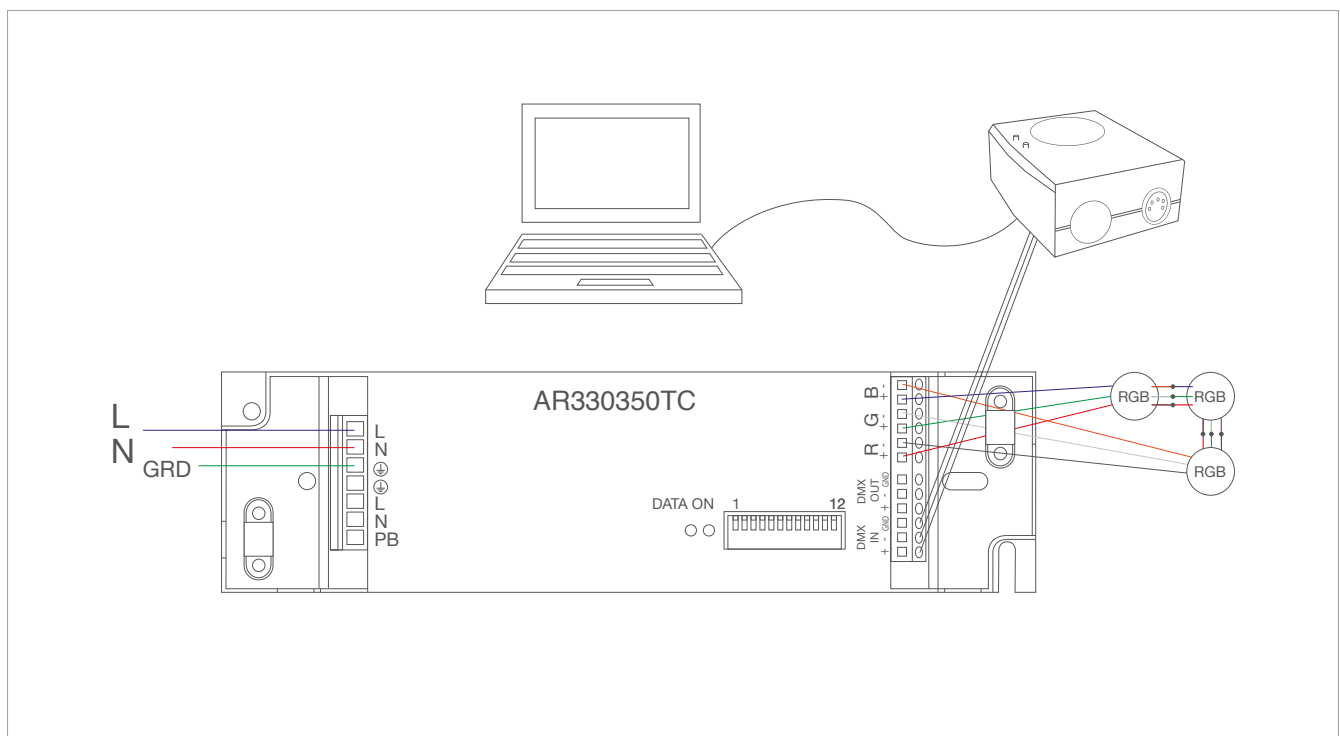

MULTICHANNEL WI-FI/RF CONTROLLER

Wi-Fi/RF control devices that enable low-voltage lighting fixtures to be controlled in different modes:

- Wi-Fi/RF controller managed via smartphone using Wi-Fi-106 app.
Different types of LED fixtures can be controlled: dimmable, 2- or 3-channel dynamic white, RGB and RGBW; up to 12 different zones can be managed, and connection is either direct or via a home router.
The Wi-Fi-106 app is available free of charge on the App Store and Google Play.
- two 4-channel controllers for constant current loads (350/700/1050mA) or constant voltage loads (12/24Vdc) connected via 2.4 GHz radio frequency directly to touch panels. Handling is intuitive and installation is very quick, with no need for interconnecting cables.

The option of using a DMX512 control bus allows the system to be configured into zones and managed separately or in synchrony with each other.

CODE	INput	INput command	OUTput	OUTput POWER 4 ch (RGBW)	Dimensions	IP
ECCTS1284CC20	12V—48V	RF 2.4GHz Radio frequency from touch panel	(Vout=Vin-2) 350mA const 700mA const 1050mA const	12V 24V 48V 16W 32W 64W 23W 46W 128W 48W 96W 193W	178x48x33 mm	IP20
ECCTS5244CV20	12V—24V	RF 2.4GHz Radio frequency from touch panel	(Vout=Vin) max 5A/ch max 20A tot	max 240W (12Vdc) max 480W (24Vdc)	178x48x33 mm	IP20
ECCTR1244CV20	12V—24V	APP WIFI-106	(Vout=Vin) max 4A/ch max 16A tot	max 192W (12Vdc) max 384W (24Vdc) RF 2.4 GHz	128x73x45 mm	IP20

CODE	INput	INput command	OUTput	OUTput POWER	Dimensions	IP
ECCTS5241DM20	12V—24V	RF 2.4 GHz da ECCTR1244CV20	bus DMX512		55x55x21 mm	IP20

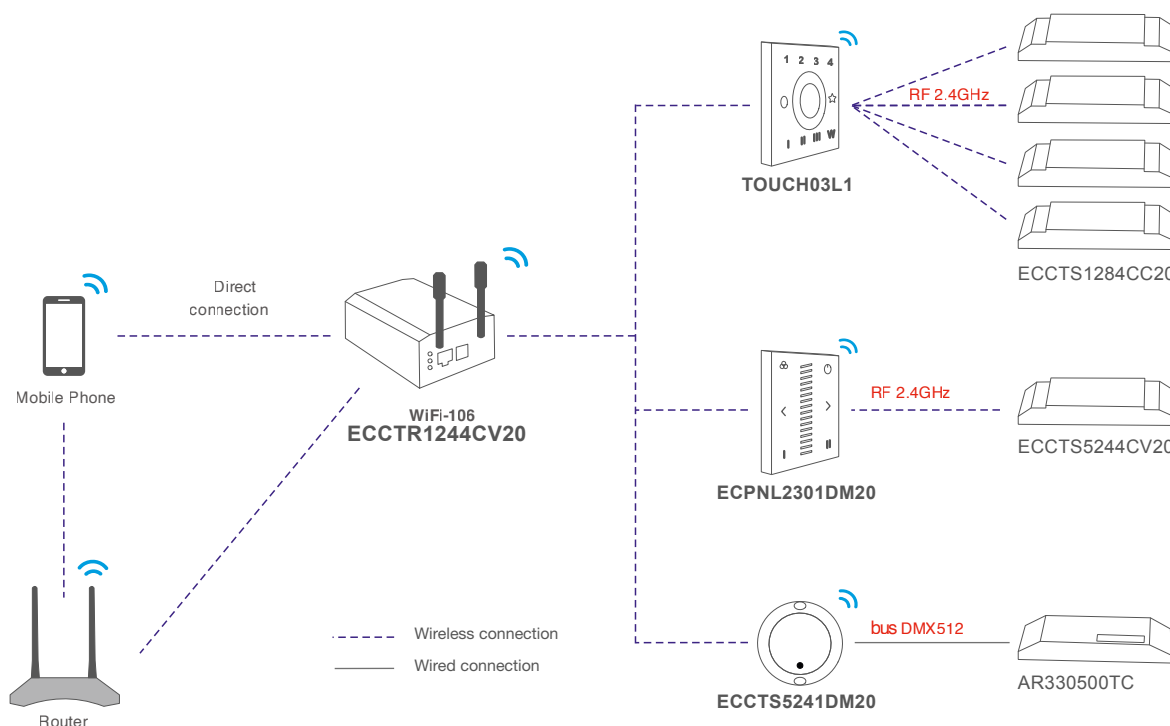

CASAMBI MESH NETWORK

Casambi is a system designed for managing lighting wirelessly: based on Bluetooth Low Energy technology, the Casambi system can be controlled directly from a smartphone or tablet, thanks to the Android- and iOS-compatible app.

Casambi technology enables you to switch lights on and off, set and activate customized lighting scenarios and dim lighting fixtures.

The technology is based on a mesh network in which all the system's intelligence is replicated in each node, thus bypassing any points of failure.

Thanks to the mesh network, firmware updates can be performed without any invasive intervention and with minimal use of wiring.

All Casambi devices are smart and able to function even without an internet connection; the latter is only required during configuration.

It is possible to connect 127 units to a single network.

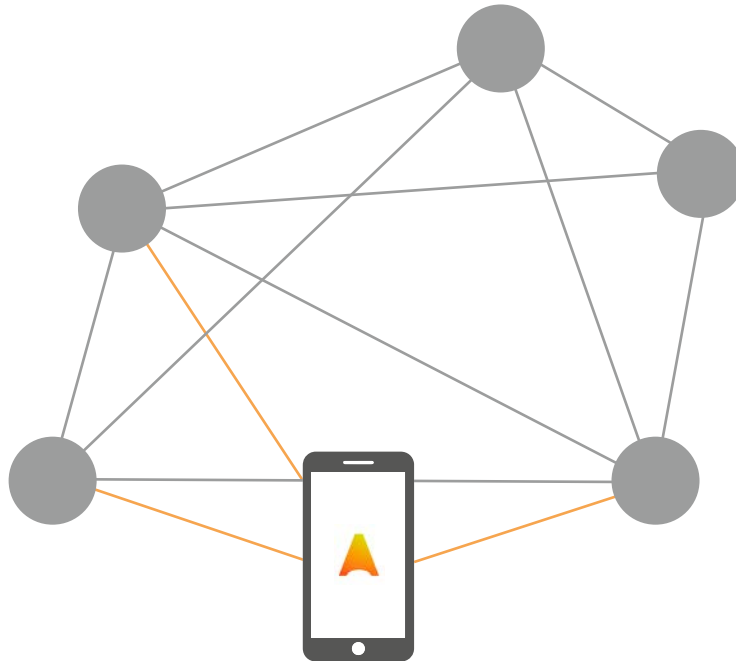

CASAMBI MESH NETWORK

CASAMBI MONO/MULTICHANNEL CONTROLLER

The Casambi app automatically recognizes L&L lighting fixtures and lets you control them easily and fully.

You can create lighting scenes with white light, dynamic white, RGB and RGBW, and program timings for them.

Most L&L products are compatible with the Casambi app: simply add one of the available controllers at the time of purchase or any time thereafter. Suitable L&L fixtures are identified by the Casambi logo.

The Casambi app is available free of charge on the App Store and Google Play.

- ECOEN12443520 4-channel low-voltage controller with constant current output (350mA);
- ECOEN12445020 4-channel low-voltage controller with constant current output (500mA);
- ECOEN12445A20 4-channel low-voltage controller with constant voltage output.

These devices allow you to adjust brightness, create multiple lighting scenes and achieve the colour effects you want using commands that can be controlled from the Casambi app.

The devices have four (NO) push button inputs so you can activate up to four scenes.

- ECOTIM12840020 timer: synchronizes Casambi scenes and programming in the event of a blackout or power failure;
 - ECOEN1244DA20 Casambi single-channel low-voltage LED dimmer capable of controlling monochromatic loads;
- It also has one (NO) push-button input to activate the set scene via the app.

CODE	INput	INput command	Outputs	OUTput (Vout=Vin-1)	OUTput POWER 4 ch (RGBW)	Dimensions	IP
ECOEN12443520	12V - 24V	PUSH APP CASAMBI	4	350mA const	15.4W (12Vdc) 32W (24Vdc)	88x54x25 mm	IP20
ECOEN12445020	12V - 24V	PUSH APP CASAMBI	4	500mA const	22W (12Vdc) 46W (24Vdc)	88x54x25 mm	IP20
ECOEN12445A20	12V - 24V	PUSH APP CASAMBI	4	max 5A/ch max 10A tot	max 120W (12Vdc) max 240W (24Vdc)	88x54x25 mm	IP20
ECOTIM12840020	12V - 24V	PUSH APP CASAMBI		radio frequency	2.4 GHz	57x44x20 mm	IP20

CODE	INput	INput command	Outputs	OUTput (Vout=Vin)	OUTput POWER 1 ch (dimmer)	Dimensions	IP
ECOEN1244DA20	12V - 24V	PUSH APP CASAMBI	1	max 10A tot	max 120W (12Vdc) max 240W (24Vdc)	57x44x20 mm	IP20

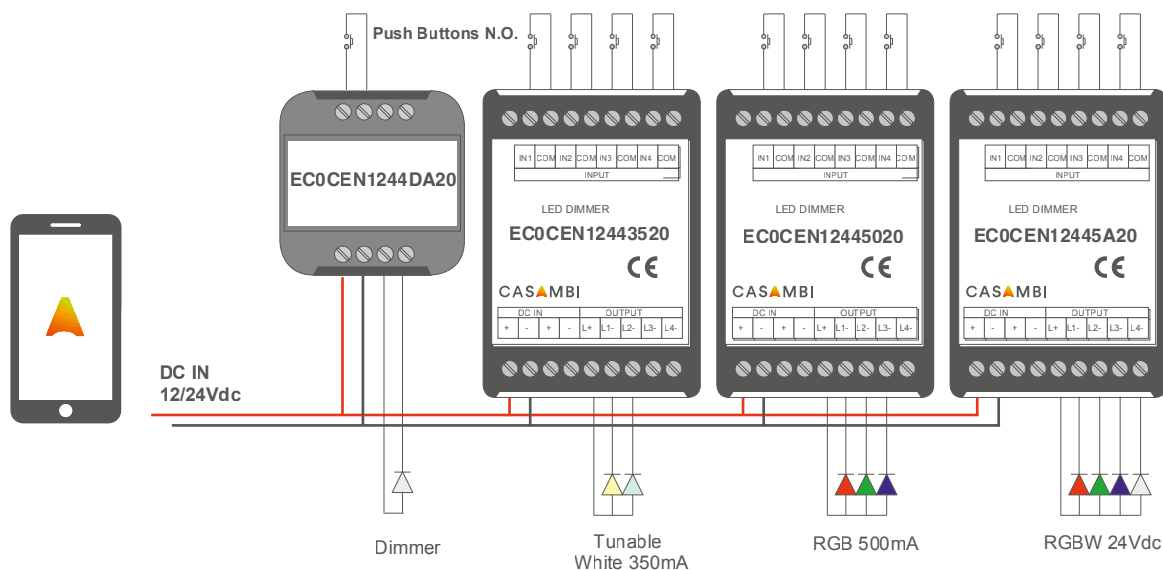

LOW VOLTAGE DC/DC CONVERTERS

SWITCH-MODE POWER SUPPLY SYSTEM + DC/DC CONVERTER

This power supply system combines AC/DC voltage power supply units with low voltage DC/DC converters for LEDs: This makes it possible to develop simple and extremely reliable power supply systems for LEDs that provide high power at low costs. With this power supply system, several converters can be connected to a single line.

To identify the correct components that can be used in systems that combine switch-mode power supply units with DC/DC converters, we suggest you follow the steps below:

1. consider the type of device to be powered (350mA for 1W);
 2. consider the current supplied to the secondary by the DC/DC converter;
 3. consider the maximum manageable power depending on the input voltage (12Vdc; 24Vdc);
 4. calculate the total power required by the system (for example: ten 3W fixtures => $10 \times 3 = 30W$).
- At this point you can select the switch-mode power supply best suited to your system (40W, for example), bearing in mind that this type of power supply works best when loaded to 90% of its maximum capacity.

As an example, to create a system with six 350mA (3W) fixtures using a 24Vdc power supply, you would need three WFA024350 and one AV24040IP67

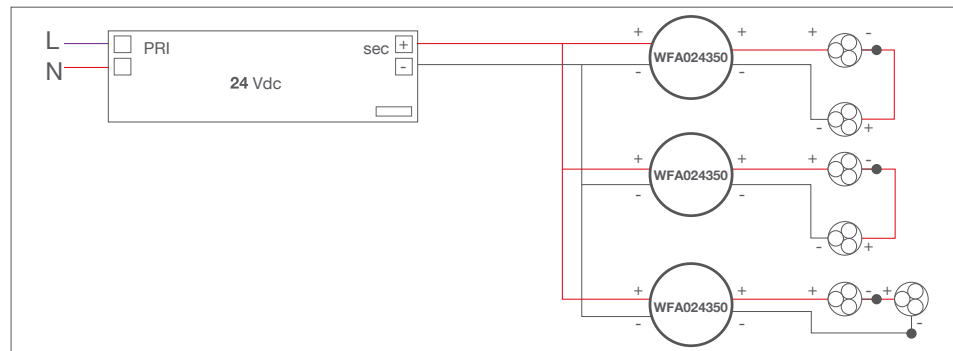

to create a system with three 500mA (5W) fixtures with two lines, you would need two WFA024500 and one AV24040IP67

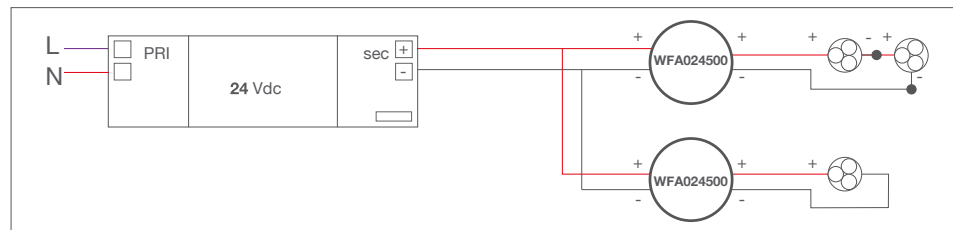

or

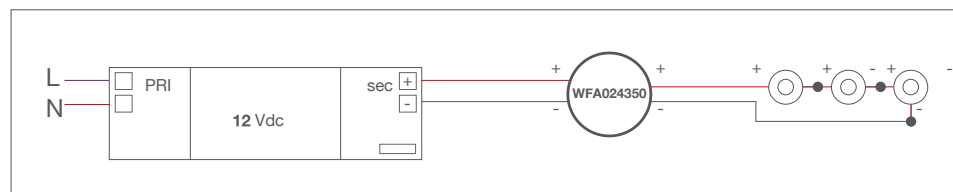

IP20 DC/DC CONVERTERS

CODE	Power	INput	PWM	OUTput	Dimensions		IP
WFA024350	4W (12Vdc) 8W (24Vdc)	12Vdc 24Vdc	2KHz	350mA	Ø16x63 mm 11 g	Ø20 mm	IP20
WFA024500	5W (12Vdc) 11W (24Vdc)	12Vdc 24Vdc	2KHz	500mA	Ø16x63 mm 11 g	Ø20 mm	IP20
WFA024700	7W (12Vdc) 16W (24Vdc)	12Vdc 24Vdc	2KHz	700mA	Ø16x63 mm 11 g	Ø20 mm	IP20

EMERGENCY KIT

The emergency kit is designed to work with LED drivers connected in series.

When mains power is present, the emergency kit functions as a battery charger.

In the absence of mains power, it steps in to keep a connected lighting fixture powered for at least one hour.

AE01350T1

The AE01350T1 emergency unit is a very versatile device: it can function in only non-maintained or in non-maintained and maintained light in conjunction with electronic transformers (maximum input voltage 90V, maximum input current 2A).

It can be adjusted using DIP switches and operates at constant current with power LEDs or constant voltage with LED modules.

The unit activates immediately in the event of a mains power outage and is equipped with:

- high-temperature Ni-Cd batteries, 1-hr life;
- LED charging indicator;
- protection device against extended discharges.

The unit has an IP20 ingress protection rating and complies with the standards:

EN61347-2-13, EN61347-2-7, EN61547, EN55015, EN60598-2-22, EN61000-3-2, SELV.

Technical and operating specifications:

- Supply voltage: 220V - 240V – 50Hz - 60Hz;
- Supply current: 20mA;
- Max operating temperature measured on the casing: 70°C;
- Ambient temperature: 5–50°C;
- Charge time: 24hr;
- Terminal block range: 1.5 mm²;
- LED mounting hole: Ø8.8 mm;
- Battery pack cable length: 200 mm;
- Charging device with basic isolation capable of recharging the battery normally after the test described in article 22.3 of CEI EN 61347-2-7:2007-09.

The charging device is protected against short circuits.

DIP switch position (dual in-line package)	Emergency work voltage (VL)	Emergency output current (I)	Max no. power LEDs in current	Max power for LED modules in voltage
A	9–12V	350mA	12/Vf	24W
B	9–24V	350mA - 250mA	24/Vf	30W
C	9–46V	350mA - 100mA	46/Vf	
D	9–58V	350mA - 85mA	60/Vf	



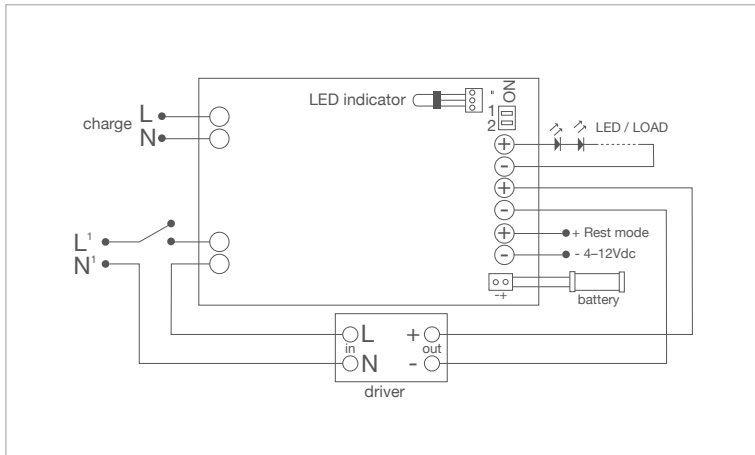

NB: 3-hr battery kit available on request

ORDINARY + EMERGENCY LIGHTING

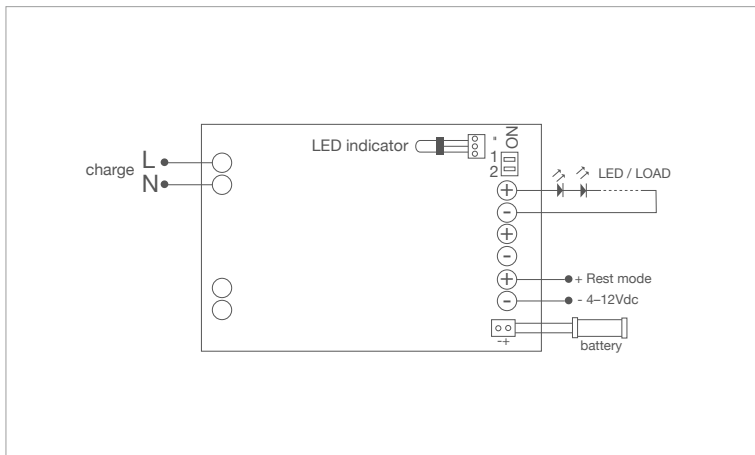

EMERGENCY ONLY











CODE	INput	OUTput	Dimensions		IP	Certifications
AE01350T1	220Va c- 240Vac 50Hz - 60Hz	max 350mA max 58Vdc	35x47x166 mm 185 g	Ø58 mm	IP20	   









ACCESSORIES













SPARE PARTS

 <p>Pair of end caps for outer casing for deep-set installation WABR100A (Brenta 1)</p>	 <p>Pair of end caps for outer casing for deep-set installation WABR200A (Brenta 2)</p>	 <p>Pair of end caps for outer casing for flush installation WABR100F (Brenta 1)</p>
 <p>Pair of end caps for outer casing for flush installation WABR200F (Brenta 2)</p>	 <p>Tool for tamper-resistant screws WE0100 (Rondò 1.1 / 1.2 / 2.1 / 3.1 / 3.2 / 3.4)</p>	 <p>Magnet for adjustable optics and zoom lens WE0201 (Bright 3.F / 5.F; Ginko 3.0 / 3.4 / 4.0; Litus 5.4 / 5.5; Pivot 2.0; Quilatero 3.0 / 3.1 / 4.0 / 4.1; Smoothy 5.4; Stra 1.0 / 5.0; Stra P 1.0 / 5.0)</p>
 <p>Accessory for positioning filters WE0301 (Akro 1.0 / 1.1 / 1.2)</p>	 <p>3-pin female connector WF0320 (Brenta 1 / 2)</p>	 <p>IP68 "h"-type three-way connector 4-pin WFA02 (Tago 1.0 / 1.1 / 1.3 / 2.0 / 2.1 / 2.3 / 3.0 / 3.1 / 3.3 / 4.0 / 4.1 / 4.3 / 5.0 / 5.1 / 5.3 / 6.0 / 6.1 / 6.3)</p>













 <p>Pair of U-shaped brackets WN6002 (Neva Mini 1 / 2 / 5 / 6 / 7 Neva 1.0 / 1.1 / 1.2 / 2.0 / 2.1 / 2.2 / 3.0 / 3.1 / 3.2 / 4.0 / 4.1 / 4.2 / 5.0 / 5.1 / 5.2 / 6.0 / 6.1 / 6.2 / 7.0 / 7.1 / 7.2 Rio 2.0 / 2.1 / 2.2 / 2.3 / 2.4)</p>	 <p>Pair of springs WN6003 (Neva Mini 1 / 2 / 5 / 6 / 7 Neva 1.0 / 1.1 / 1.2 / 2.0 / 2.1 / 2.2 / 3.0 / 3.1 / 3.2 / 4.0 / 4.1 / 4.2 / 5.0 / 5.1 / 5.2 / 6.0 / 6.1 / 6.2 / 7.0 / 7.1 / 7.2)</p>	 <p>Pair of extractors for outer casings WN7001 (Bright 3.0 316L; Stra 1.0 / 2.0 / 3.0 / 4.0 / 5.0)</p>
 <p>Pair of extractors for outer casings WN6006 (Colorado 2.0 / 2.1 / 2.2 / 5.0 / 5.1 / 5.2; Neva Mini 1 / 2 / 5 / 6 / 7 Neva 1.0 / 1.1 / 1.2 / 2.0 / 2.1 / 2.2 / 3.0 / 3.1 / 3.2 / 4.0 / 4.1 / 4.2 / 5.0 / 5.1 / 5.2 / 6.0 / 6.1 / 6.2 / 7.0 / 7.1 / 7.2; Rio 1.0 / 1.1 / 1.2 / 1.3 / 1.4 / 2.0 / 2.1 / 2.2 / 2.3 / 2.4; Tago 2.0 / 2.1 / 2.3 / 5.0 / 5.1 / 5.3)</p>	 <p>Pair of U-shaped brackets WN8003 (Rio 1.0 / 1.1 / 1.2 / 1.3 / 1.4)</p>	 <p>Alignment kit for stainless steel outer casings WN8011 (Rio 1.0 / 1.1 / 1.2 / 1.3 / 1.4 / 2.0 / 2.1 / 2.2 / 2.3 / 2.4)</p>
 <p>Pair of extractors for outer casings WNB000A (Brenta 1 / 2)</p>		

WIRING MATERIALS

 <p>Connection box, 3 exits Cable diameter: from 5.5 to 9.5 mm IP54 without screws IP67 with screws</p> <p>WF0300 85x85x22 mm</p>	 <p>Gel-filled four-way cable joint Cable diameter: from 6.5 to 12 mm IP68</p> <p>WF0301 105x44x24 mm</p>	 <p>Gel-filled straight-through cable joint Cable diameter: from 8 to 10 mm IP68</p> <p>WF0304 30x42x45 mm</p>
 <p>3-pin connector Cable diameter: from 5 to 12 mm Pointed screws IP68</p> <p>WF0313 Ø23x68 mm</p>	 <p>4-pin connector Cable diameter: from 5 to 12 mm Pointed screws IP68</p> <p>WF0314 Ø23x68 mm</p>	 <p>5-pin male-female connector Cable diameter: from 5 to 12 mm Pointed screws IP68</p> <p>WF0315 Ø23x95 mm</p>
 <p>2-pin male connector Cable diameter: from 7 to 12 mm Pointed screws IP66-IP68</p> <p>WFA00 Ø23x48 mm</p>	 <p>4-pin male connector Cable diameter: from 7 to 12 mm Pointed screws IP68</p> <p>WFA01 Ø23x85 mm</p>	 <p>3-pin female connector IP66-IP68</p> <p>WFA03</p>
 <p>3-pin male connector IP66-IP68</p> <p>WFA04</p>	 <p>5-pin male connector Cable diameter: from 7 to 12 mm Pointed screws IP66-IP68</p> <p>WFA05 Ø23x48 mm</p>	 <p>2-pin male-female connector IP66-IP68</p> <p>WFA06</p>



 <p>2-pin female connector IP66-IP68 WFA10</p>	 <p>4-pin female connector IP66-IP68 WFA11</p>	 <p>5-m, 3-pin interconnect cable for DMX signal WFA0001</p>
 <p>5-m, 4-pin interconnect cable for DALI or 0/1-10V version WFA0005</p>	 <p>1.5-m, 4-pin interconnect cable for DALI or 0/1-10V version WFA0101</p>	 <p>5-m, 3-pin interconnect cable for DMX signal WFA0105</p>
 <p>1.5-m, 5-pin interconnect cable WFA0201</p>	 <p>5-m, 5-pin interconnect cable WFA0205</p>	 <p>Potentiometer WX05</p>
 <p>Synchronization cable, 1.5 m WX06</p>	 <p>Synchronization cable, 4 m WX07</p>	

POWER CABLES

<p>PVC cable FROR 2x0.50 Ø5.0 mm WF0100 Your choice of length</p>	<p>PVC cable FROR 2x0.35 Ø3.5 mm WF0110 Your choice of length</p>	<p>PVC cable FROR 6x0.25 Ø5.0 mm WF0210 Your choice of length</p>
<p>Neoprene cable 05RN-F 2x0.35 Ø4.3 mm WF0510 Your choice of length</p>	<p>Grey PVC cable HT105° 2x0.20 Ø3.0 mm WF0600 Your choice of length</p>	<p>PVC cable HT105° 2x0.20 Ø3.0 mm, black WF4000 Your choice of length</p>

order together with the lighting fixture



WARRANTY



L&L Luce&Light offers all Buyers who purchase its products a warranty of 24 months against manufacturing and/or design defects as provided for under the General Terms And Conditions of L&L Luce&Light.

During the warranty period, the Buyer may submit a complaint to L&L Luce&Light together with a copy of the purchase invoice and the certification issued by the installer attesting the installation of the Product in accordance with the applicable regulations.

Given the high quality of its products, L&L Luce&Light is able to offer its Buyers the possibility of extending the term of the above warranty to 5 years from the date of invoice.

This service is offered at no additional charge.

To request a warranty extension, you must make the request within three months of the date of invoice, using the warranty extension form available on the website (www.lucelight.it).

Once the form has been completed in full, the warranty will be extended to a period of 5 years from the date of invoice, as provided for in the L&L Luce&Light General Terms and Conditions, considered to be accepted in full.

Acceptance of the request for extension is subject to the correct and complete compilation of the warranty extension form in all its parts by the Buyer; L&L Luce&Light shall assign an identification code to the warranty extension and give notice thereof to the Buyer.

SYMBOLS



RGB



RGBW



Dynamic white



Shades of cyan



Complies with the European standard EN 60598-1



CB certification



EAC certification



BIS certification



Device with LED technology



Appliance class I



Appliance class II



Appliance class III



Walk-over fixture



Drive-over fixture



Product's gross weight including power cable

IP

Rating for protection against the ingress of solid particles and liquids

IP69K

Resistance to cleaning with high-pressure, high-temperature spray-downs (ISO-20653 compliant)

IK

Rating for impact resistance

CASAMBI

Compatibility with app

0/1-10V

Analogue dimming system

DALI
DALI-2

Digital Addressable Lighting Interface Digital dimming system

DMX

Digital Multiple X Communication protocol for lighting fixtures

DMX RDM

RDM - Remote Device Management Bi-directional communication protocol for lighting fixtures



Energy efficiency class



Electrical Protection System



Intelligent Protection System



Protective Impedance Device



Surge Protection Device

NTC

Thermistor mounted on LED board



RAL finish on request



Total volume



Cut-out size

Tmax

Max temperature of lighting fixture



Version with neutral and adhering primer so the body of the fixture can be painted with wall paint



Built-in speaker

INDEX OF PRODUCTS, POWER SUPPLY UNITS AND ACCESSORIES BY CODE

A			ADUNITC			B		
A13350VL	Power supply unit	P. 907		Power supply unit	P. 910			
A13500TC	Power supply unit	P. 905			P. 911			
		P. 907			P. 912	BB10101000___	Berica IN 1.0	P. 612
A13700IP67	Power supply unit	P. 907	ADV576DALIN1	Dimmer	P. 916	BB11101_00___	Berica IN 1.1	P. 613
A13700QL	Power supply unit	P. 907	AE01350T1	Emergency kit	P. 928	BB12101_00___	Berica IN 1.2	P. 613
A14500IP67	Power supply unit	P. 907			P. 929	BB20101000___	Berica IN 2.0	P. 614
A15500QL	Power supply unit	P. 905	AK1000___N	Akro 1.0	P. 308	BB21101_00___	Berica IN 2.1	P. 615
		P. 907	AK1110___N	Akro 1.1	P. 309	BB22101_00___	Berica IN 2.2	P. 615
A16350IP67	Power supply unit	P. 907	AK1210___ND	Akro 1.2	P. 309	BB30101000___	Berica IN 3.0	P. 616
A19220TC	Power supply unit	P. 906	AP1010__0__0__	Altopiano 1.0	P. 74	BB31101_00___	Berica IN 3.1	P. 617
A19350QL	Power supply unit	P. 907	AP1110__0__0__	Altopiano 1.1	P. 74	BB32101_00___	Berica IN 3.2	P. 617
A310500IP67	Power supply unit	P. 907	AP2010__0__0__	Altopiano 2.0	P. 75	BC1000___0	Bitpop C 1.0	P. 652
A310500QL	Power supply unit	P. 907	AP2110__0__0__	Altopiano 2.1	P. 75	BC2210_____	Bitpop C 2.2	P. 653
A312350IP67	Power supply unit	P. 907	AP3010__0__0__	Altopiano 3.0	P. 76	BC4110_____	Bitpop C 4.1	P. 653
A312350QL	Power supply unit	P. 907	AP3110__0__0__	Altopiano 3.1	P. 77	BP10_0_____	Bitpop 1.0	P. 532
A39700IP67	Power supply unit	P. 907	AR330350TC	Power supply unit	P. 918	BP211_____	Bitpop 2.1	P. 533
ACUNIO20T1	Power supply unit	P. 906	AR330500TC	Power supply unit	P. 918	BP221_____	Bitpop 2.2	P. 533
		P. 907	ARC336350D1	Easy RGB	P. 917	BP411_____	Bitpop 4.1	P. 534
ACUNIO32T1	Power supply unit	P. 906	ARC336500D1	Easy RGB	P. 917	BP811_____	Bitpop 8.1	P. 535
ACUNIO39T1	Power supply unit	P. 906	ARC336700D1	Easy RGB	P. 917	BR1_1_1_0B_	Brenta 1	P. 686
		P. 907	ARCUNID2-01	Universal Sequencer	P. 919	BR2_1_1_0B_	Brenta 2	P. 688
ACUNIO42T1	Power supply unit	P. 906	ARV230PD1	Easy RGB	P. 917	BR10012__I	Brom 1.0	P. 366
ACUNIC30T1	Power supply unit	P. 906	ARVUNID2-01	Universal sequencer	P. 919	BR20022__I	Brom 2.0	P. 366
		P. 907	AV12020IP20	Power supply unit	P. 908	BR30032__I	Brom 3.0	P. 367
AD018350TLT1	Dimmer	P. 910	AV12040IP67	Power supply unit	P. 908	BR40062__I	Brom 4.0	P. 367
		P. 915	AV12060IP67	Power supply unit	P. 908	BS10101_00_D__	Berica S 1.0	P. 670
AD020500TLT1	Dimmer	P. 910	AV12150IP67	Power supply unit	P. 908	BS11101_00_D__	Berica S 1.1	P. 671
		P. 915	AV12192IP67	Power supply unit	P. 908	BS12101_00_D__	Berica S 1.2	P. 671
AD020DALIT1	Power supply unit	P. 910	AV24008IP54	Power supply unit	P. 908	BS20101_00_D__	Berica S 2.0	P. 672
		P. 914	AV24010IP20	Power supply unit	P. 908	BS21101_00_D__	Berica S 2.1	P. 673
AD030DALIT1AM	Dimmer	P. 910	AV24020IP67	Power supply unit	P. 905	BS22101_00_D__	Berica S 2.2	P. 673
		P. 911			P. 908	BS30101_00_D__	Berica S 3.0	P. 674
		P. 914	AV24040IP67	Power supply unit	P. 908	BS31101_00_D__	Berica S 3.1	P. 675
AD030DALIT1	Dimmer	P. 910	AV24060IP20	Power supply unit	P. 905	BS32101_00_D__	Berica S 3.2	P. 675
		P. 911			P. 908	BT1010_A_	Bitta 1.0	P. 485
		P. 914	AV24060IP67	Power supply unit	P. 908	BT1110_A_	Bitta 1.1	P. 485
AD032TLT1	Dimmer	P. 910	AV24100IP20	Power supply unit	P. 908	BU1010_000___	Berica OUT 1.0	P. 318
		P. 911	AV24150IP20	Power supply unit	P. 908	BU1110__00___	Berica OUT 1.1	P. 319
		P. 915	AV24150IP67	Power supply unit	P. 908	BU1210__00___	Berica OUT 1.2	P. 319
AD050DALIT1	Dimmer	P. 910	AV24240IP67	Power supply unit	P. 908	BU2010_000___	Berica OUT 2.0	P. 320
		P. 911	AV24320IP67	Power supply unit	P. 908	BU2110__00___	Berica OUT 2.1	P. 321
		P. 912	AV36060IP67	Power supply unit	P. 909	BU2210__00___	Berica OUT 2.2	P. 321
		P. 914	AV48060IP67	Power supply unit	P. 909	BU3010_000___	Berica OUT 3.0	P. 322
AD050PUSHT1	Dimmer	P. 910	AV48150IP20	Power supply unit	P. 909	BU3110__00___	Berica OUT 3.1	P. 323
		P. 911	AV48150IP67	Power supply unit	P. 909	BU3210__00___	Berica OUT 3.2	P. 323
		P. 912	AV48240IP67	Power supply unit	P. 909			

C

CA10100_0_0_N	Colorado 1.0	P. 152
CA11100_0_0_N	Colorado 1.1	P. 153
CA12100_0_0_N	Colorado 1.2	P. 153
CA20100_0_0_V	Colorado 2.0	P. 154
CA21100_0_0_V	Colorado 2.1	P. 155
CA22100_0_0_V	Colorado 2.2	P. 155
CA30100_0_0_N	Colorado 3.0	P. 156
CA31100_0_0_N	Colorado 3.1	P. 157
CA32100_0_0_N	Colorado 3.2	P. 157
CA4010040070_N	Colorado 4.0	P. 158
CA4110040070_N	Colorado 4.1	P. 159
CA4210040070_N	Colorado 4.2	P. 159
CA5010040070_V	Colorado 5.0	P. 160
CA5110040070_V	Colorado 5.1	P. 161
CA5210040070_V	Colorado 5.2	P. 161
CA6010040070_N	Colorado 6.0	P. 162
CA6110040070_N	Colorado 6.1	P. 163
CA6210040070_N	Colorado 6.2	P. 163
CB1012_AI	Bright 1.0	P. 94
CB1112_AI	Bright 1.1	P. 95
CB1212_AI	Bright 1.2	P. 95
CB1600_I	Bright 1.6	P. 97
CB1700_I	Bright 1.7	P. 97
CB1A130_TI	Bright 1.A	P. 415
CB1B0_0_TI	Bright 1.B	P. 415
CB24_	Bright 2.4	P. 98
CB25_	Bright 2.5	P. 99
CB280_0_	Bright 2.8	P. 101
CB290_0_I	Bright 2.9	P. 101
CB3F0_0_0_I	Bright 3.F	P. 102
CB3G0_0_0_I	Bright 3.G	P. 103
CB3H00000070_I	Bright 3.H	P. 103
CB5F0_00_0_I	Bright 5.F	P. 104
CB5G0_00_0_I	Bright 5.G	P. 105
CB5H00000070_I	Bright 5.H	P. 105
CB47000_RI	Bright 4.7	P. 417
CB97000_RI	Bright 9.7	P. 417
CC10201000_0_0	Combina D 1.0	P. 504
CC11201000_0_0	Combina D 1.1	P. 504
CC2020_000_0_0	Combina D 2.0	P. 506
CC2120_000_0_0	Combina D 2.1	P. 506
CC3020_000_0_0	Combina D 3.0	P. 508
CC3120_000_0_0	Combina D 3.1	P. 508
CC4020_000_0_0	Combina D 4.0	P. 510
CC4120_000_0_0	Combina D 4.1	P. 510
CD101__A	Beam 1.0	P. 141
CD20__DA	Beam 2.0	P. 408
CD21__DA	Beam 2.1	P. 408
CD26__D	Beam 2.6	P. 409
CD27__D	Beam 2.7	P. 409
CF1012_AI	Spot 1.0	P. 275
CF1600_I	Spot 1.6	P. 275
CF24100000_0_	Spot 2.4	P. 276
CF34100000_0_	Spot 3.4	P. 277
CF441_0000_0_	Spot 4.4	P. 279
CK10101_	Ciak 1.0	P. 542
CK11101_	Ciak 1.1	P. 542
CK16001_	Ciak 1.6	P. 543
CK17001_	Ciak 1.7	P. 543
CK26001_	Ciak 2.6	P. 545
CK27001_	Ciak 2.7	P. 545
CL211__A	Linear 2.1	P. 474
CL221__A	Linear 2.2	P. 474
CL2310_A	Linear 2.3	P. 475
CL2410_A	Linear 2.4	P. 475
CL411__A	Linear 4.1	P. 478
CL421__A	Linear 4.2	P. 479
CL4410_A	Linear 4.4	P. 479
CM10201000_0_	Cameo 1.0	P. 548
CM11201000_0_	Cameo 1.1	P. 549
CM12201000_R1_	Cameo 1.2	P. 549
CM16001000_0_	Cameo 1.6	P. 550
CM17001000_0_	Cameo 1.7	P. 551
CM18001000_R1_	Cameo 1.8	P. 551
CM26001000_0_	Cameo 2.6	P. 552
CM27001000_0_	Cameo 2.7	P. 553
CM28001000_R1_	Cameo 2.8	P. 553
CP170_	Pivot 1.7	P. 246
CP010_00_0_	Pivot Mini 1	P. 245
CP1820N00_60_	Pivot 1.8	P. 247
CP200_00_	Pivot 2.0	P. 249
CR1010000__0_I	Corso 1.0	P. 128
CR2010000__0_I	Corso 2.0	P. 128
CR3010000__0_I	Corso 3.0	P. 129
CR40100_0_0_I	Corso 4.0	P. 129
CS1010__I	Stra 1.0	P. 136
CS2010__I	Stra 2.0	P. 136
CS3010__I	Stra 3.0	P. 137
CS4010__I	Stra 4.0	P. 137
CS50007_H	Stra 5.0	P. 138
CU103_	Cube W 1.0	P. 369
CU113_	Cube W 1.1	P. 369
CU123_	Cube C 1.2	P. 387
CU133_	Cube C 1.3	P. 387
CW1012_AI	Bright 1.0 316L	P. 730
CW1600_I	Bright 1.6 316L	P. 731
CW2032_AI	Bright 2.0 316L	P. 733
CW2600_I	Bright 2.6 316L	P. 733
CW30_	Bright 3.0 316L	P. 736
CW50_2_AI	Bright 5.0 316L	P. 737

D

DMX01	DMX controller	P. 923
DU1010_00_0_	Duomo 1.0	P. 256
DU2010_00_0_	Duomo 2.0	P. 256
DU3010_0_0_	Duomo 3.0	P. 257
DU4010_0_0_	Duomo 4.0	P. 257

E

EA1010_D_N	Ella IN 1.0	P. 624
EA1010_D_T	Ella OUT 1.0	P. 352
EA2010_D_N	Ella IN 2.0	P. 625
EA2010_D_T	Ella OUT 2.0	P. 353
EA3010_D_N	Ella IN 3.0	P. 625
EA3010_D_T	Ella OUT 3.0	P. 353
ECOCEN1244__0	Controller	P. 926
ECOCEN1244DA20	Dimmer	P. 926
ECOTIM12840020	Timer	P. 926
ECCTR1244CV20	Sequencer	P. 920
	Controller	P. 924
	Controller	P. 920
ECCTS1284CC20	Sequencer	P. 920
	Controller	P. 924
ECCTS5241DM20	Controller	P. 921
		P. 924
ECCTS5244CV20	Sequencer	P. 920
	Controller	P. 924
ECPNL2301DM20	Touchscreen	P. 922
EM1031_	Esem Mid 1.0	P. 558
EM1131_	Esem Mid 1.1	P. 558
EM1600_	Esem Mid 1.6	P. 559
EM1700_	Esem Mid 1.7	P. 559
EP1010_D_N	Ello IN 1.0	P. 660
EP1010_D_T	Ello OUT 1.0	P. 382
EP2010_D_N	Ello IN 2.0	P. 661
EP2010_D_T	Ello OUT 2.0	P. 383
EP3010_D_N	Ello IN 3.0	P. 661

EP3010_D_T	Ello OUT 3.0	P. 383
ES2012_EB	Esem 2.0	P. 561
ES2600_B	Esem 2.6	P. 561
ES3010___	Esem 3.0	P. 562
ES3100___	Esem 3.1	P. 563
ES3200___	Esem 3.2	P. 563
ES4010___	Esem 4.0	P. 564
ES4100___	Esem 4.1	P. 565
ES4200___	Esem 4.2	P. 565
EY1011___	Eyes 1.0	P. 568
EY1211___	Eyes 1.2	P. 568
EY1611__	Eyes 1.6	P. 569
EY1811___	Eyes 1.8	P. 569
EY2R201000_0__	Eyes 2.R	P. 570
EY2S201000_0__	Eyes 2.S	P. 570
EY2T001000_0__	Eyes 2.T	P. 571
EY2U001000_0__	Eyes 2.U	P. 571

F

FB101_____	LED optical fibres	P. 581
FL1270_D	Line 1.0	P. 700
FS1010___	Flori 1.0	P. 284
FS1110___	Flori 1.1	P. 284
FS12007__	Flori 1.2	P. 285
FS13007__	Flori 1.3	P. 285

G

GE01201000_0__	Gem Mini 1	P. 600
GE1120100_0__	Gem 1.1	P. 601
GE2120100_0__	Gem 2.1	P. 601
GK501_D	Geko 5.0	P. 338
GK5110___	Geko 5.1	P. 338
GK601_D	Geko 6.0	P. 339
GK6110___	Geko 6.1	P. 339
GN100___	Ginko 1.0	P. 229
GN1401_R1	Ginko 1.4	P. 229
GN200___	Ginko 2.0	P. 230
GN22326__	Ginko 2.2	P. 231
GN2401_R1	Ginko 2.4	P. 231
GN300___	Ginko 3.0	P. 234
GN3401___	Ginko 3.4	P. 235
GN4000_00_0__	Ginko 4.0	P. 237

K

KA111___	Kocca 1.1	P. 344
KA121___	Kocca 1.2	P. 344
KA1310___	Kocca 1.3	P. 345
KA1410___	Kocca 1.4	P. 345
KA311___	Kocca 3.1	P. 346
KA321___	Kocca 3.2	P. 347
KA3410___	Kocca 3.4	P. 347
KC10_01_0_0_B	Kit Combina D 1.0	P. 512
KC20_01_0_0_B	Kit Combina D 2.0	P. 513
KI10201000_0__	Krill 1.0	P. 592
KI14201000_R1	Krill 1.4	P. 592
KI20201000_0__	Krill 2.0	P. 593
KI24201000_R1	Krill 2.4	P. 593
KI30201000_0__	Krill 3.0	P. 595
KI34201000_R1	Krill 3.4	P. 595
KR101010___	Kora 1.0	P. 678
KR2010___	Kora 2.0	P. 679
KR3010___	Kora 3.0	P. 679

L

L1___0__	Wall 1	P. 634
LE1011_DAV	Ice LED 1.0	P. 449
LE1111_DAV	Ice LED 1.1	P. 449
LM10000___	Lyss Mini 1.0	P. 298
LN1112_A	Line 1.1	P. 700
LN2012_A	Line 2.0	P. 701
LN2112_A	Line 2.1	P. 701
LR1010_A	Lira 1.0	P. 445
LR2010_A	Lira 2.0	P. 445
LT1010_NV	Litus 1.0	P. 112
LT1110_NV	Litus 1.1	P. 112
LT160___NV	Litus 1.6	P. 113
LT170___NV	Litus 1.7	P. 113
LT24___	Litus 2.4	P. 114
LT25___	Litus 2.5	P. 115
LT280___NV	Litus 2.8	P. 116
LT290___NV	Litus 2.9	P. 116
LT540___NV	Litus 5.4	P. 117
LT550___NV	Litus 5.5	P. 117
LT56___	Litus 5.6	P. 120
LT57___	Litus 5.7	P. 121
LY101___	Lyss 1.0	P. 299
LY20007U	Lyss 2.0	P. 299

M

MB1000_DI	Bright Mini 1.0	P. 93
MB1100_DI	Bright Mini 1.1	P. 93
ME1012___	Esem Mini 1.0	P. 556
ME1112___	Esem Mini 1.1	P. 556
ME1600___	Esem Mini 1.6	P. 557
ME1700___	Esem Mini 1.7	P. 557
MP1000_I	Moby P 1.0	P. 746
MP1100_V	Moby P 1.1	P. 746
MP2000_I	Moby P 2.0	P. 747
MP2100_V	Moby P 2.1	P. 747
MP3000_I	Moby P 3.0	P. 749
MP3100_V	Moby P 3.1	P. 749
MT10_1_DB	Turis Mini 1.0	P. 517
MT11_1_D	Turis Mini 1.1	P. 517
MY1000_I	Moby 1.0	P. 720
MY1100_V	Moby 1.1	P. 720
MY2000_I	Moby 2.0	P. 721
MY2100_V	Moby 2.1	P. 721
MY3000_I	Moby 3.0	P. 725
MY3100_V	Moby 3.1	P. 725

N

NC2310_00___	Intono C IN 2.3	P. 646
NC2410_00___	Intono C OUT 2.4	P. 376
NC3310_0___	Intono C IN 3.3	P. 647
NC3410_0___	Intono C OUT 3.4	P. 377
NC3800_00_M9	Intono C IN 3.8	P. 647
NC3900_00_M9	Intono C OUT 3.9	P. 377
NT1100_00_0___	Intono 1.1	P. 329
NT1200_00_____	Intono 1.2	P. 329
NT2110_00_0__	Intono 2.1	P. 331
NT2210_00_____	Intono 2.2	P. 331
NT3110_0_0__	Intono 3.1	P. 332
NT3210_0_____	Intono 3.2	P. 333
NT3900_00_9	Intono 3.9	P. 333
NT4110_0_0__	Intono 4.1	P. 334
NT4210_0_____	Intono 4.2	P. 335
NT4900_00_9	Intono 4.9	P. 335
NV010__A	Neva Mini 1	P. 188
NV020__A	Neva Mini 2	P. 190
NV05006_A	Neva Mini 5	P. 198
NV0600H_A	Neva Mini 6	P. 200
NV07007_A	Neva Mini 7	P. 202
NV100__A	Neva 1.0	P. 188

NV110__A	Neva 1.1	P. 189
NV120__A	Neva 1.2	P. 189
NV200__A	Neva 2.0	P. 190
NV210__A	Neva 2.1	P. 191
NV220__A	Neva 2.2	P. 191
NV30100_0_0_N	Neva 3.0	P. 194
NV31100_0_0_N	Neva 3.1	P. 195
NV3210000_0_N	Neva 3.2	P. 195
NV40100_0_0_N	Neva 4.0	P. 196
NV41100_0_0_N	Neva 4.1	P. 197
NV42100_0_0_N	Neva 4.2	P. 197
NV500_6_A	Neva 5.0	P. 198
NV51006_A	Neva 5.1	P. 199
NV52006_A	Neva 5.2	P. 199
NV6000H_A	Neva 6.0	P. 200
NV6100H_A	Neva 6.1	P. 201
NV6200H_A	Neva 6.2	P. 201
NV70007_A	Neva 7.0	P. 202
NV71007_A	Neva 7.1	P. 203
NV72007_A	Neva 7.2	P. 203

P

PA10_0_0_0_0	Pasito 1.0	P. 426
PA11_0_0_0_0	Pasito 1.1	P. 427
PA12_0_0_0_0	Pasito 1.2	P. 427
PL1_8_0_0_0	Wall 3	P. 635
PL801240_0_0_0_0	Wall 8.0	P. 636
PL811_40_0_0_0	Wall 8.1	P. 637
PL821_40_0_0_0	Wall 8.2	P. 637
PM10_0_000_0_0_0	Pasito Mini 1.0	P. 424
PM11_0_0_0_0	Pasito Mini 1.1	P. 425
PM12_0_0_0_0	Pasito Mini 1.2	P. 425
PN1010_A_0_0_0_0	Plin 1.0	P. 458
PN1110_A_0_0_0_0	Plin 1.1	P. 459
PN1210_A_0_0_0_0	Plin 1.2	P. 459
PN2010_A_0_0_0_0	Plin 2.0	P. 460
PN2110_A_0_0_0_0	Plin 2.1	P. 461
PN2210_A_0_0_0_0	Plin 2.2	P. 461
PN3010_A_0_0_0_0	Plin 3.0	P. 462
PN3110_A_0_0_0_0	Plin 3.1	P. 463
PN3210_A_0_0_0_0	Plin 3.2	P. 463
PN40100_D_0_0_0_0	Plin 4.0	P. 464
PN41100_D_0_0_0_0	Plin 4.1	P. 465
PN42100_D_0_0_0_0	Plin 4.2	P. 465
PN50100_A_0_0_0_0	Plin 5.0	P. 466
PN51100_A_0_0_0_0	Plin 5.1	P. 467

PN52100_A_0_0_0_0	Plin 5.2	P. 467
PN60100000_0A_0_0_0_0	Plin 6.0	P. 468
PN61100000_0A_0_0_0_0	Plin 6.1	P. 469
PN62100000_0A_0_0_0_0	Plin 6.2	P. 469
PS1010__H_0_0_0_0	Stra P 1.0	P. 291
PS50007_H_0_0_0_0	Stra P 5.0	P. 292
PW1012_AI_0_0_0_0	Spot 1.0 316L	P. 754
PW1600_I_0_0_0_0	Spot 1.6 316L	P. 754
PW2032_AI_0_0_0_0	Spot 2.0 316L	P. 755
PW2600_I_0_0_0_0	Spot 2.6 316L	P. 755
PW30_2_AI_0_0_0_0	Spot 3.0 316L	P. 757

Q

QD6132__0_0_0_0	Quad 6.1	P. 576
QD6262__0_0_0_0	Quad 6.2	P. 577
QD6392__0_0_0_0	Quad 6.3	P. 577
QL1010_0_0_0_0	Quilatero 1.0	P. 63
QL1110_0_0_0_0	Quilatero 1.1	P. 63
QL2010_0_0_0_0	Quilatero 2.0	P. 64
QL2110_0_0_0_0	Quilatero 2.1	P. 64
QL2410_0_0_0_0	Quilatero 2.4	P. 65
QL2510_0_0_0_0	Quilatero 2.5	P. 65
QL3010_0_0_0_0	Quilatero 3.0	P. 66
QL3110_0_0_0_0	Quilatero 3.1	P. 66
QL3410_0_0_0_0	Quilatero 3.4	P. 67
QL3510_0_0_0_0	Quilatero 3.5	P. 67
QL4010_0_0_0_0	Quilatero 4.0	P. 68
QL4110_0_0_0_0	Quilatero 4.1	P. 68
QL4410_0_0_0_0	Quilatero 4.4	P. 69
QL4510_0_0_0_0	Quilatero 4.5	P. 69

R

RD1100__0_0_0_0	Rondò 1.1	P. 398
RD1200__0_0_0_0	Rondò 1.2	P. 399
RD2100__0_0_0_0	Rondò 2.1	P. 399
RD31_0_0_0_0	Rondò 3.1	P. 402
RD32_0_0_0_0	Rondò 3.2	P. 403
RD34_0_0_0_0	Rondò 3.4	P. 403
RE1000_DB_0_0_0_0	Rio 1.0	P. 211
RE1100_DB_0_0_0_0	Rio 1.1	P. 211
RE1200_DB_0_0_0_0	Rio 1.2	P. 212
RE1300_DB_0_0_0_0	Rio 1.3	P. 213
RE1400_DB_0_0_0_0	Rio 1.4	P. 213
RE2000_DB_0_0_0_0	Rio 2.0	P. 215
RE2100_DB_0_0_0_0	Rio 2.1	P. 215

RE2200_DB_0_0_0_0	Rio 2.2	P. 216
RE2300_DB_0_0_0_0	Rio 2.3	P. 217
RE2400_DB_0_0_0_0	Rio 2.4	P. 217
RS1100_DB_0_0_0_0	Rio Sub 1.1	P. 772
RS1200_DB_0_0_0_0	Rio Sub 1.2	P. 772
RS2100_DB_0_0_0_0	Rio Sub 2.1	P. 773
RS2200_DB_0_0_0_0	Rio Sub 2.2	P. 773

S

SL1010__H_0_0_0_0	Siri BLVD 1.0	P. 490
SL2010__H_0_0_0_0	Siri BLVD 2.0	P. 491
SL3010__H_0_0_0_0	Siri BLVD 3.0	P. 491
SM1011_D_0_0_0_0	Simply 1.0	P. 711
SP2012_DA_0_0_0_0	Step Outside 2.0	P. 432
SP2112_DA_0_0_0_0	Step Outside 2.1	P. 432
SP2212_D_0_0_0_0	Step Inside 2.2	P. 706
SP2312_D_0_0_0_0	Step Inside 2.3	P. 706
SP2600_D_0_0_0_0	Step Outside 2.6	P. 433
SP2700_D_0_0_0_0	Step Outside 2.7	P. 433
SP2800_D_0_0_0_0	Step Inside 2.8	P. 707
SP2900_D_0_0_0_0	Step Inside 2.9	P. 707
SP5112_AA_0_0_0_0	Step Outside 5.1	P. 435
SP5212_AA_0_0_0_0	Step Outside 5.2	P. 435
SP6112_AA_0_0_0_0	Step Outside 6.1	P. 436
SP6212_AA_0_0_0_0	Step Outside 6.2	P. 437
SP6312_AA_0_0_0_0	Step Outside 6.3	P. 437
SP7000_A_0_0_0_0	Step Outside 7.0	P. 439
SP8000_A_0_0_0_0	Step Outside 8.0	P. 439
SR1010__0_0_0_0	Siri 1.0	P. 264
SR1110__0_0_0_0	Siri 1.1	P. 264
SR12007__0_0_0_0	Siri 1.2	P. 265
SR13007__0_0_0_0	Siri 1.3	P. 265
SR2010__0_0_0_0	Siri 2.0	P. 266
SR2110__0_0_0_0	Siri 2.1	P. 266
SR22007__0_0_0_0	Siri 2.2	P. 267
SR23007__0_0_0_0	Siri 2.3	P. 267
SR3010__0_0_0_0	Siri 3.0	P. 268
SR3110__0_0_0_0	Siri 3.1	P. 268
SR32007__0_0_0_0	Siri 3.2	P. 269
SR33007__0_0_0_0	Siri 3.3	P. 269
SY1012__I_0_0_0_0	Smoothy 1.0	P. 83
SY160__I_0_0_0_0	Smoothy 1.6	P. 83
SY24__0_0_0_0	Smoothy 2.4	P. 84
SY280__I_0_0_0_0	Smoothy 2.8	P. 85
SY540__I_0_0_0_0	Smoothy 5.4	P. 86
SY56__0_0_0_0	Smoothy 5.6	P. 87

T

TA1011_D	Tak 1.0	P. 389
TA111_	Tak 1.1	P. 389
TG10100_0_0_N	Tago 1.0	P. 170
TG11100_0_0_N	Tago 1.1	P. 171
TG13100_0_0_N	Tago 1.3	P. 171
TG20100_0_0_V	Tago 2.0	P. 172
TG21100_0_0_V	Tago 2.1	P. 173
TG23100_0_0_V	Tago 2.3	P. 173
TG30100_0_0_N	Tago 3.0	P. 174
TG31100_0_0_N	Tago 3.1	P. 175
TG33100_0_0_N	Tago 3.3	P. 175
TG4030040070_N	Tago 4.0	P. 176
TG41_0040070_N	Tago 4.1	P. 177
TG43_0040070_N	Tago 4.3	P. 177
TG5030040070_V	Tago 5.0	P. 178
TG51_0040070_V	Tago 5.1	P. 179
TG53_0040070_V	Tago 5.3	P. 179
TG6030040070_N	Tago 6.0	P. 180
TG61_0040070_N	Tago 6.1	P. 181
TG63_0040070_N	Tago 6.3	P. 181
TK501_DB	Teko 5.0	P. 656
TK511_DB	Teko 5.1	P. 656
TK701_DB	Teko 7.0	P. 657
TK7110_DB	Teko 7.1	P. 657
TLC08	Radio control	P. 921
TLC09	Radio control	P. 921
TLC10	Radio control	P. 921
TLC15	Radio control	P. 921
TLC16	Radio control	P. 921
TLC17	Radio control	P. 921
TLR02-01	Controller with integrated receiver	P. 921
TLR03	Controller with integrated receiver	P. 921
TLR04M-350-500	Controller with integrated receiver	P. 921
TLR04M-350-700	Controller with integrated receiver	P. 921
TLR05S-350	Extender	P. 921
TLR05S-500	Extender	P. 921
TLR07	Receiver	P. 921
TOUCH02L1	Touchscreen	P. 922
TOUCH03L1	Touchscreen	P. 922
TR1000_A	Trevi 1.0	P. 766
TR1100_A	Trevi 1.1	P. 767

TR1200_A	Trevi 1.2	P. 767
TU101__D__	Turis 1.0	P. 518
TU110__D__	Turis 1.1	P. 518
TU121__D__	Turis 1.2	P. 519
TU131__D__	Turis 1.3	P. 519
TU201__DB	Turis 2.0	P. 523
TU301__D__	Turis 3.0	P. 524
TU310__D__	Turis 3.1	P. 524
TU321__D__	Turis 3.2	P. 525
TU331__D__	Turis 3.3	P. 525
TU401__DB	Turis 4.0	P. 526
TU501__D__	Turis 5.0	P. 527
TU510__D__	Turis 5.1	P. 527

U

UD303__	Updown 3.0	P. 358
UD3600__	Updown 3.6	P. 358
UD4061__	Updown 4.0	P. 359
UD4600__	Updown 4.6	P. 359
UD6022__	Updown 6.0	P. 360
UD70_2__	Updown 7.0	P. 361

V

VR1010_DB	Versa 1.0	P. 629
VR2010_DB	Versa 2.0	P. 629

W

WABR100A	Pair of end caps	P. 932
WABR100F	Pair of end caps	P. 932
WABR200A	Pair of end caps	P. 932
WABR200F	Pair of end caps	P. 932
WCO302	Outer casing	P. 922
WE0100	Tool for tamper-resistant screws	P. 932
WE0201	Magnet	P. 932
WE0301	Accessory for positioning filters	P. 932
WF0100	Cable	P. 936
WF0110	Cable	P. 936
WF0210	Cable	P. 936
WF0300	Connection box	P. 934
WF0301	Connection box	P. 934
WF0304	Connection box	P. 934
WF0313	Connector	P. 934

WF0314	Connector	P. 934
WF0315	Connector	P. 934
WF0320	Connector	P. 932
WF0510	Cable	P. 936
WF0600	Cable	P. 936
WF4000	Cable	P. 936
WFA00	Connector	P. 934
WFA06	Connector	P. 934
WFA0_01	Cable	P. 935
WFA0_05	Cable	P. 935
WFA01	Connector	P. 934
WFA02	Connector	P. 932
WFA020_	Cable	P. 935
WFA024__0	Converter	P. 927
WFA03	Connector	P. 934
WFA04	Connector	P. 934
WFA05	Connector	P. 934
WFA10	Connector	P. 935
WFA11	Connector	P. 935
WGA0_	Fixing springs	P. 79
WMA0_N	Pair of brackets	P. 165 P. 183
WN6002	U-shaped brackets, pair	P. 933
WN6003	Pair of springs	P. 933
WN6006	Pair of extractors	P. 933
WN7001	Pair of extractors	P. 933
WN8003	U-shaped brackets, pair	P. 933
WN8011	Alignment kit	P. 933
WNAP10A0	Anti-fall kit	P. 79
WNBRO00A	Extractors pair	P. 933
WX05	Potentiometer	P. 910 P. 912 P. 935
WX06	Synchronization cable	P. 910 P. 912 P. 935
WX07	Synchronization cable	P. 910 P. 912 P. 935

LED EXPERIENCE

Given the continuous evolution of LED technology, the technical characteristics of the lighting fixtures may vary with respect to those given in this publication. For this reason, the information contained herein shall be deemed merely indicative and not binding for the Company. The technical reference documentation is available in the download section for each product on the L&L website:

WWW.LUCELIGHT.IT

CONCEPT AND ART DIRECTION
WE ARE DESIGN

© L&L LUCE&LIGHT SRL. 2023
ALL RIGHTS RESERVED

REV01 01/2023



PRINTED IN ITALY

Grafiche Antiga spa

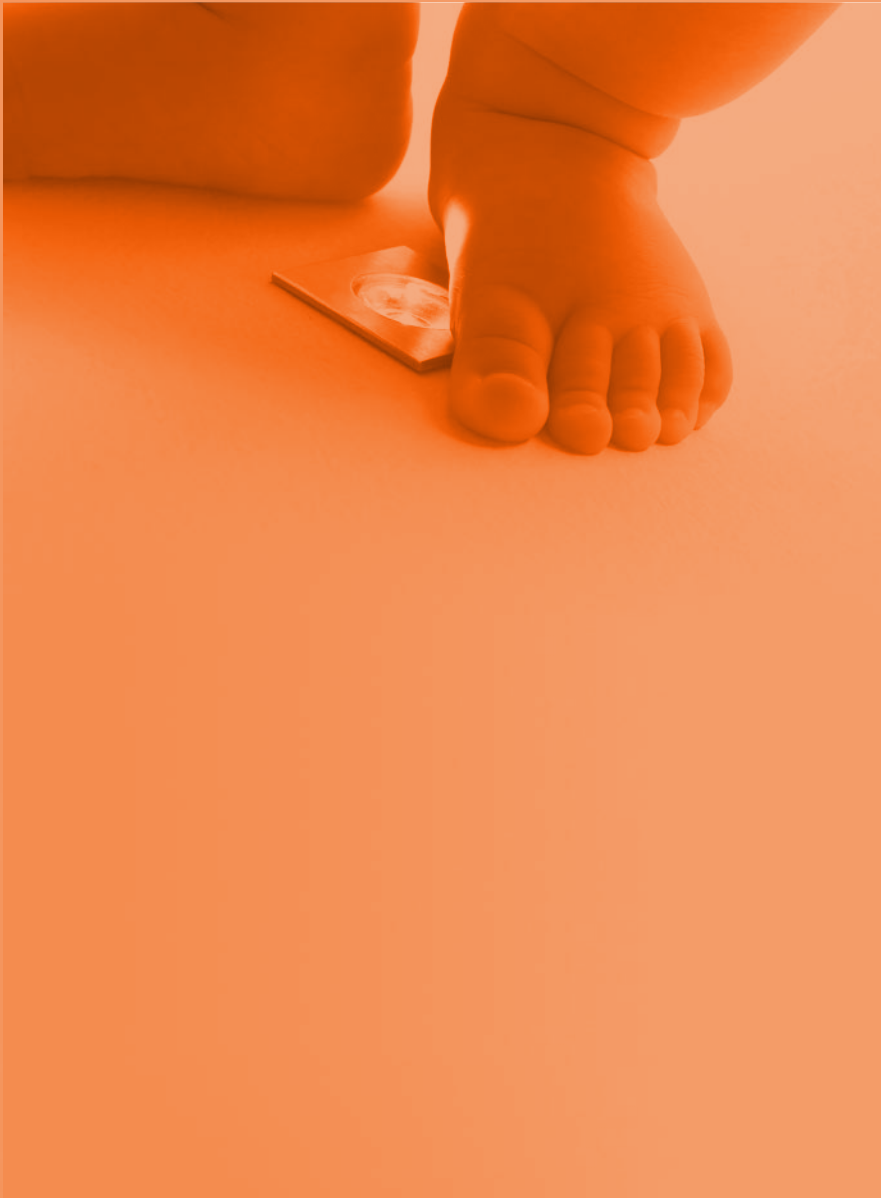

L&L Luce&Light srl
Via Trescalini, 5
36031 Dueville, Vicenza - Italy

T +39 0444 36 05 71
E lucelight@lucelight.it
W www.lucelight.it

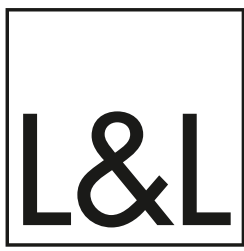

L u c e & L i g h t

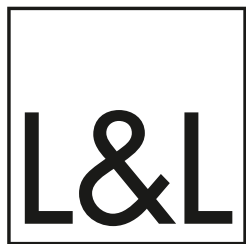

L u c e & L i g h t