

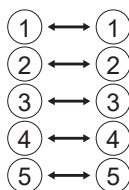

CE IP66 IP68

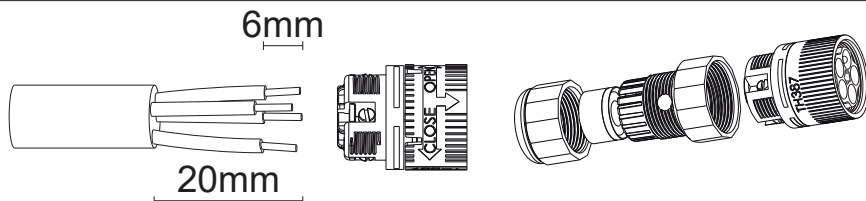

See the instruction of the product
 Vedere le istruzioni del prodotto
 Afficher l'instruction du produit
 Lesen Sie dieAnweisungen des Produkts
 Ver la instrucción del producto

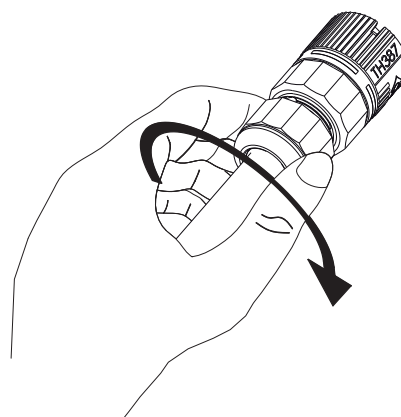
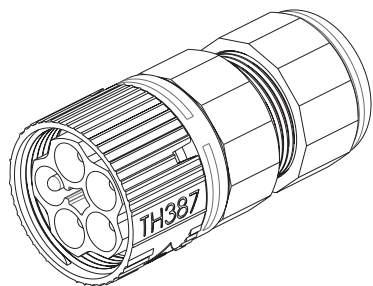
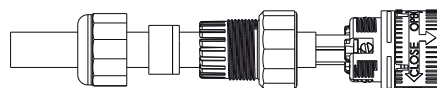
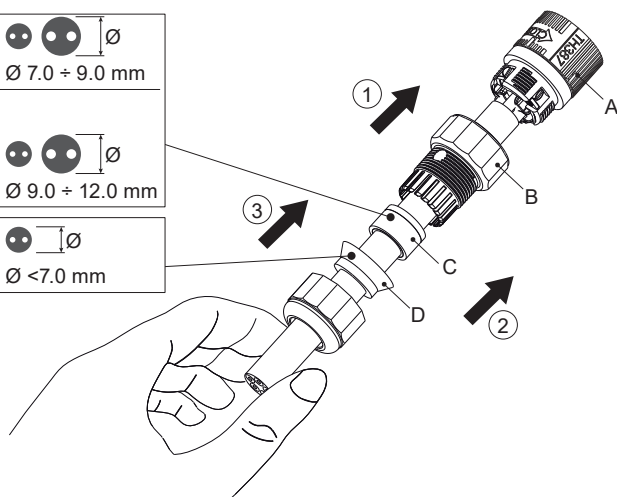
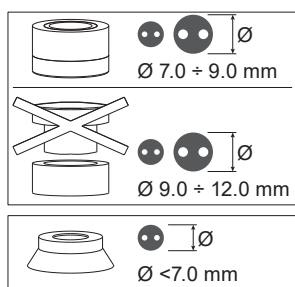

After wiring, tighten cable gland "B" on trim "A", then insert grommet "C" on cable gland "B". Finally, insert the adapter "D" and firmly fix nut "E" on cable gland "B".

Dopo il cablaggio, serrare bene il passacavo "B" sulla ghiera "A", quindi inserire il gommino "C" sul passacavo "B". Infine, inserire l'adattatore "D" e fissare bene il dado "E" sul passacavo "B".

Après le câblage, bien serrer le joint de câble «B» sur la collerette «A», puis introduire le rond en caoutchouc «C» sur le joint de câble «B». Enfin, insérez l'adaptateur «D» et bien fixer l'écrou «E» sur le joint de câble «B».

Nach erfolgter Verkabelung die Kabelverschraubung "B" gut am Rahmen "A" festziehen, dann den Dichtungsring "C" auf die Kabelverschraubung "B" schieben. Anschließend Schluss den Adapter "D" einsetzen und die Mutter "E" gut an der Kabelverschraubung "B" anziehen.

Después de realizar la conexión, ajustar bien el pasacables "B" en el aro "A", después introducir el tubo de goma "C" en el pasacables "B". Por último, inserte el adaptador "D" y ajustar bien la tuerca "E" en el pasacables "B".