

Made in Italy

 Rio 1.3, code: RE13007DB
Linear profiles for outdoor applications

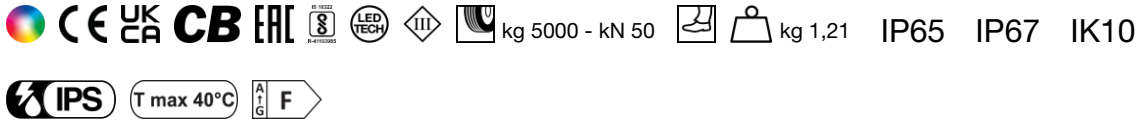

23/05/2026 Rev. 25/2024

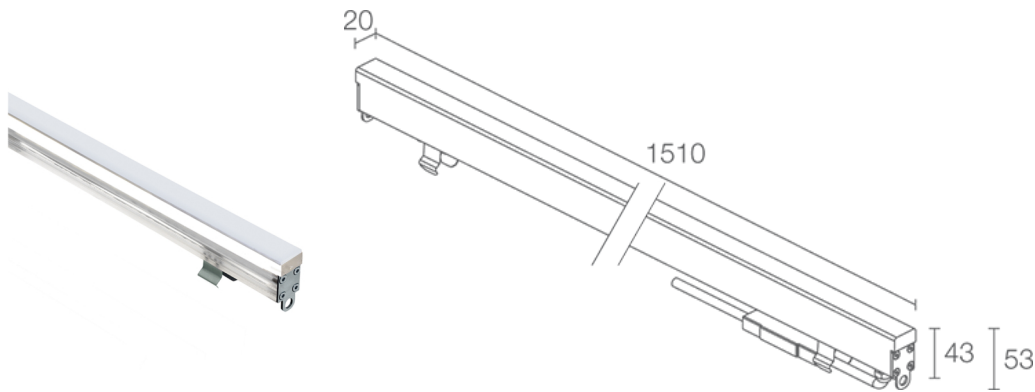

DESCRIPTION

linear profile for outdoor applications; drive-over up to 5000 kg; walkover; recessed (ceiling, wall, floor); Power consumption: 34W; Power supply: 24Vdc; Lumen output at source: RGBW: 1731 lm, R: 229 lm G: 534 lm B: 104 lm W: 864 lm (3000K); Delivered lumen output: RGBW: 540 lm, R: 84 lm G: 192 lm B: 36 lm W: 312 lm (3000K); 432 SMD LED full colour + LED white, 50 000h L95 B10 (Ta 25°C); LED colour: RGBW; Optics: diffuse; Body material: body and screen made of co-extruded opal PMMA to provide high strength combined with high aesthetics. Caps in AISI 316L stainless steel and screws in A4 stainless steel; Seals: silicone rubber O-rings with anti-ageing treatment for an excellent mechanical seal; power supply unit not included; includes 1.50 m FEP+RUB cable (equivalent to H05RN-F) 6x0.50/0.50 Ø6.3 mm; Ingress protection: IP65, IP67; Impact resistance: IK10; drive-over up to 5000 kg with aluminium casing, drive-over up to 500 kg with stainless steel casing. Non-standard lengths available on request; Casambi control using the Casambi app with dedicated electronics; Protection systems: IPS (Intelligent Protection System) protects lighting fixtures from water infiltrations, which can occur if there are faulty junctions between the cables in outdoor or underwater applications. This innovation, patented by L&L, also guarantees electrical protection against polarity reversal, hot plugging, ESD and power surges, which can occur if there are faults in the electrical circuit; Operating temperature: -20°C — +45°C; Maximum device temperature: 40°C (Ta 25°C); Photobiological safety: photobiological safety: risk group 1 according to EN 62471:2006; Appliance class: class III; Weight: 1210 g; Dimensions: 1510x20x43 mm; Energy efficiency class: F (light source) in accordance with EU 2019/2015; Accessories: WC8113 Aluminium outer casing - 1515 mm, WC8153 Stainless steel outer casing - 1514 mm, WC8313 Aluminium outer casing for plasterboard - 1515 mm, WN6005 Alignment kit for outer casing, WN6006 Pair of extractors for outer casings, WN8003 U-shaped brackets pair, WN8011 Alignment kit for stainless steel outer casings, WN8101 Anti-fall kit; tested and approved via E.O.L. (End Of Line) test with functioning test and check of electrical power consumption

Status: Available

ELECTRICAL CHARACTERISTICS

Power consumption	34W
Power supply	24Vdc
Power supply unit	power supply unit not included

LIGHTING CHARACTERISTICS

Number and type of LED	432 SMD LED full colour + LED white
Average LED life	50 000h L95 B10 (Ta 25°C)
LED colour	RGBW
Optics	diffuse
Lumen output at source	RGBW: 1731 lm, R: 229 lm G: 534 lm B: 104 lm W: 864 lm (3000K)
Delivered lumen output	RGBW: 540 lm, R: 84 lm G: 192 lm B: 36 lm W: 312 lm (3000K)

MECHANICAL CHARACTERISTICS

Dimensions	1510x20x43 mm
Weight	1210 g
Mounting	with outer casing
Body material	body in PMMA, screen in opal PMMA, end caps in AISI 316L stainless steel

GENERAL CHARACTERISTICS

Ingress protection	IP65, IP67
Operating temperature	-20°C — +45°C
Impact resistance	IK10
Energy efficiency class	F (light source) in accordance with EU 2019/2015
Maximum device temperature	40°C (Ta 25°C)
Appliance class	class III
Walkover	yes
Drive-over	up to 5000 kg
Power cables	includes 1.50 m FEP+RUB cable (equivalent to H05RN-F) 6x0.50/0.50 Ø6.3 mm
Protection systems	IPS (Intelligent Protection System)
Photobiological safety	photobiological safety: risk group 1 according to EN 62471:2006
Notes	drive-over up to 5000 kg with aluminium casing, drive-over up to 500 kg with stainless steel casing. Non-standard lengths available on request; Casambi control using the Casambi app with dedicated electronics

PHOTOMETRIC DATA

D – Diffuso

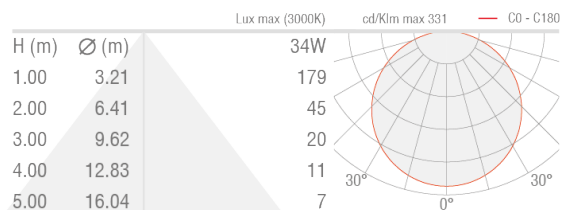

ACCESSORIES

Installation Accessories



WC8113
Aluminium outer casing - 1515 mm
drive-over: kg 5000 / kN 50

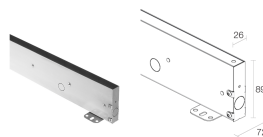

WC8153
Stainless steel outer casing - 1514 mm
drive-over: kg 500 / kN 5



WC8313
Aluminium outer casing for plasterboard - 1515 mm

Other



WN6005
Alignment kit for outer casing



WN6006
Pair of extractors for outer casings

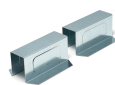

WN8003
U-shaped brackets pair



WN8011
Alignment kit for stainless steel outer casings



WN8101
Anti-fall kit

L&L Luce&Light SRL reserves the right to change the information contained in this document at any time without prior notice being given.