













Made in Italy

 Rio 1.1, code: RE11005DB  
Linear profiles for outdoor applications

18/06/2026 Rev. 25/2024

T max 40°C 

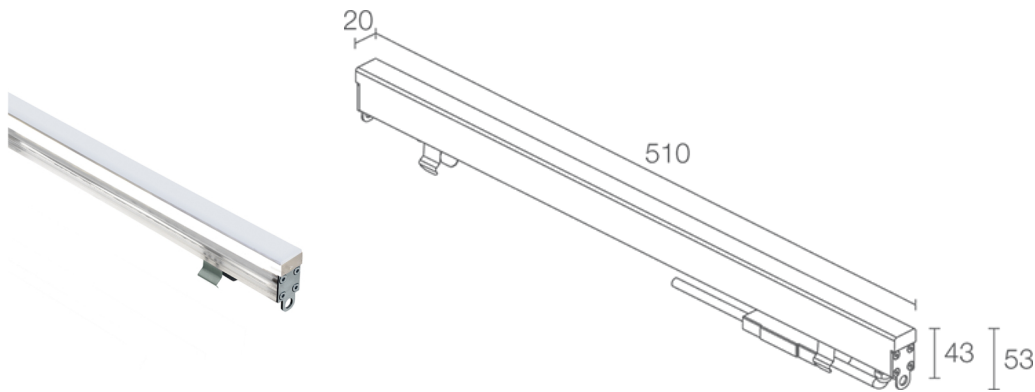

## DESCRIPTION

linear profile for outdoor applications; drive-over up to 5000 kg; walkover; recessed (ceiling, wall, floor); Power consumption: 6W; Power supply: 24Vdc; Lumen output at source: 672 lm (2800K); Delivered lumen output: 140 lm (2800K); 48 low-power SMD LEDs, 3-step MacAdam, 50 000h L95 B10 (Ta 25°C); LED colour: 2800K; Optics: diffuse: optical system consisting of light sources placed in a line on a rigid electronic circuit; CRI Colour Rendering Index: 80; Body material: body and screen made of co-extruded opal PMMA to provide high strength combined with high aesthetics. Caps in AISI 316L stainless steel and screws in A4 stainless steel; Seals: silicone rubber O-rings with anti-ageing treatment for an excellent mechanical seal; power supply unit not included; includes 1.5 m neoprene cable, H05RN-F 2x0,35/0,75 Ø6,3 mm; Ingress protection: IP65, IP67; Impact resistance: IK10; drive-over up to 5000 kg with aluminium casing, drive-over up to 500 kg with stainless steel casing. Non-standard lengths available on request; Casambi control using the Casambi app with dedicated electronics; Protection systems: IPS (Intelligent Protection System) protects lighting fixtures from water infiltrations, which can occur if there are faulty junctions between the cables in outdoor or underwater applications. This innovation, patented by L&L, also guarantees electrical protection against polarity reversal, hot plugging, ESD and power surges, which can occur if there are faults in the electrical circuit; Operating temperature: -20°C — +45°C; Maximum device temperature: 40°C (Ta 25°C); Photobiological safety: photobiological safety: risk group 1 according to EN 62471:2006; Appliance class: class III; Weight: 560 g; Dimensions: 510x20x43 mm; Energy efficiency class: F (light source) in accordance with EU 2019/2015; Accessories: WC8111 Aluminium outer casing - 514 mm, WC8151 Stainless steel outer casing - 513 mm, WC8311 Aluminium outer casing for plasterboard - 514 mm, WN6005 Alignment kit for outer casing, WN6006 Pair of extractors for outer casings, WN8003 U-shaped brackets pair, WN8011 Alignment kit for stainless steel outer casings, WN8101 Anti-fall kit; tested and approved via E.O.L. (End Of Line) test with functioning test and check of electrical power consumption

Status: Available

### ELECTRICAL CHARACTERISTICS

Power consumption	6W
Power supply	24Vdc
Power supply unit	power supply unit not included

### LIGHTING CHARACTERISTICS

Number and type of LED	48 low-power SMD LEDs
Average LED life	50 000h L95 B10 (Ta 25°C)
LED colour	2800K
CRI Colour Rendering Index	80
Binning	3-step MacAdam
Optics	diffuse
Lumen output at source	672 lm (2800K)
Delivered lumen output	140 lm (2800K)

### MECHANICAL CHARACTERISTICS

Dimensions	510x20x43 mm
Weight	560 g
Mounting	with outer casing
Body material	body in PMMA, screen in opal PMMA, end caps in AISI 316L stainless steel

### GENERAL CHARACTERISTICS

Ingress protection	IP65, IP67
Operating temperature	-20°C — +45°C
Impact resistance	IK10
Energy efficiency class	F (light source) in accordance with EU 2019/2015
Maximum device temperature	40°C (Ta 25°C)
Appliance class	class III
Walkover	yes
Drive-over	up to 5000 kg
Power cables	includes 1.5 m neoprene cable, H05RN-F 2x0,35/0,75 Ø6,3 mm
Protection systems	IPS (Intelligent Protection System)
Photobiological safety	photobiological safety: risk group 1 according to EN 62471:2006
Notes	drive-over up to 5000 kg with aluminium casing, drive-over up to 500 kg with stainless steel casing. Non-standard lengths available on request; Casambi control using the Casambi app with dedicated electronics

## PHOTOMETRIC DATA

### D – Diffuse

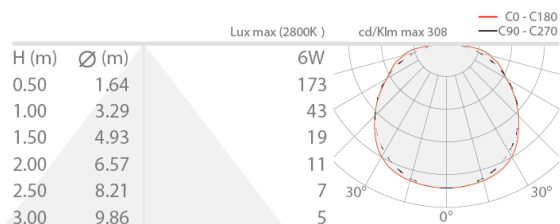

## ACCESSORIES

### Installation Accessories



#### WC8111

Aluminium outer casing - 514 mm  
drive-over: kg 5000 / kN 50

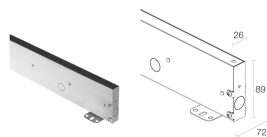

#### WC8151

Stainless steel outer casing - 513 mm  
drive-over: kg 500 / kN 5



#### WC8311

Aluminium outer casing for plasterboard - 514 mm

### Other



#### WN6005

Alignment kit for outer casing



#### WN6006

Pair of extractors for outer casings



#### WN8003

U-shaped brackets pair



#### WN8011

Alignment kit for stainless steel outer casings



**WN8101**  
Anti-fall kit

L&L Luce&Light SRL reserves the right to change the information contained in this document at any time without prior notice being given.