









Made in Italy

 **Bright 2.4 inox, code: CB240105SII-4**
Recessed for outdoor applications

17/06/2026 Rev. 13/2024





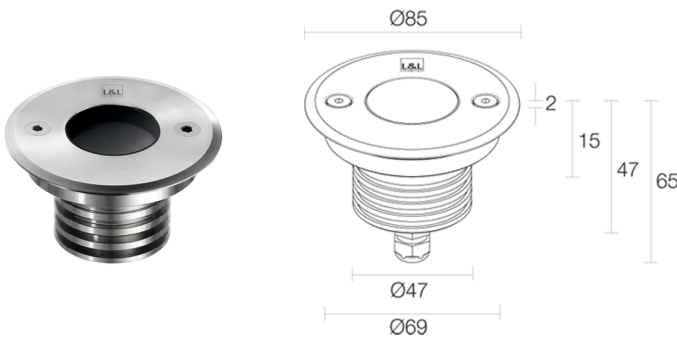

 kg 2000 - kN 20  kg 0,44 Al - kg 0,33 A **IP65 IP68 IP69**

IK10    



DESCRIPTION

recessed for outdoor applications (not suitable for use in immersion in swimming pools or fountains); drive-over up to 2000 kg; recessed (ceiling, wall, floor); Power consumption: 7W; Power supply: 24Vdc; Lumen output at source: 657 lm (3000K, 7W, CRI 80); Delivered lumen output: 463 lm (3000K, 34°, 7W, CRI 80); 1 high-intensity power LED, 3-step MacAdam, 50 000h L90 B10 (Ta 25°C); LED colour: 3000K; Optics: 17°; CRI Colour Rendering Index: 80; Body material: body and trim in AISI 316L stainless steel; Finishes: stainless steel; Body: stainless steel; Screen material: screen in tempered, transparent extra-clear glass; Thickness of installation surface: min 0 mm, max 25 mm; power supply unit not included; includes 20 m neoprene cable H05RN-F 2x0.75/0.75 Ø6.3 mm; Ingress protection: IP65, IP68, IP69; Impact resistance: IK10; version with 5° optics (with white LED colour and 3,5W power) available on request; version with 9W power (with white LED colour) available on request; Casambi control using the Casambi app with dedicated electronics; Protection systems: IPS (Intelligent Protection System) protects lighting fixtures from water infiltrations, which can occur if there are faulty junctions between the cables in outdoor or underwater applications. This innovation, patented by L&L, also guarantees electrical protection against polarity reversal, hot plugging, ESD and power surges, which can occur if there are faults in the electrical circuit; The PID (Protective Impedance Device) protects lighting fixtures from electrical phenomena external to the system, such as static electricity accumulation or electromagnetic interference coming from the mains power. Generally, these are events with a low energy content; Operating temperature: -20°C — +45°C; Maximum device temperature: 55°C (Ta 25°C); Glow wire test: 960°C; Photobiological safety: in accordance with IEC TR 62778:2014; Appliance class: class III; Weight: stainless steel trim: 440 g, aluminium trim: 330 g; Dimensions: Ø85x63 mm; Cutout dimensions: Ø70 mm; Volume of thermal heatsink: Ø 180 mm, H 120 mm; Energy efficiency class: F (light source) in accordance with EU 2019/2015; Accessories: WC0100 Outer casing, WC0103 Outer casing, WC0150 Outer casing, WE0400A Semi-diffusing screen, half transparent and half frosted, WE0400S Anti-glare screen, half transparent and half serigraphed black, WG0100 Retaining spring clip for installation on plasterboard Ø70mm, WH0201 Honeycomb louvre ; tested and approved via E.O.L. (End Of Line) test with functioning test and check of electrical power consumption

Status: Available

ELECTRICAL CHARACTERISTICS

Power consumption	7W
Power supply	24Vdc
Power supply unit	power supply unit not included

LIGHTING CHARACTERISTICS

Number and type of LED	1 high-intensity power LED
Average LED life	50 000h L90 B10 (Ta 25°C)
LED colour	3000K
CRI Colour Rendering Index	80
Binning	3-step MacAdam
Optics	17°
Lumen output at source	657 lm (3000K, 7W, CRI 80)
Delivered lumen output	463 lm (3000K, 34°, 7W, CRI 80)

MECHANICAL CHARACTERISTICS

Dimensions	Ø85x63 mm
Weight	stainless steel trim: 440 g, aluminium trim: 330 g
Finishes	stainless steel
Body	stainless steel
Mounting	with fixing springs or outer casing
Body material	body and trim in AISI 316L stainless steel
Screen material	screen in transparent, tempered extra-clear glass
Cutout dimensions	Ø70 mm
Volume of thermal heatsink	Ø 180 mm, H 120 mm

GENERAL CHARACTERISTICS

Ingress protection	IP65, IP68, IP69
Operating temperature	-20°C — +45°C
Impact resistance	IK10
Energy efficiency class	F (light source) in accordance with EU 2019/2015
Glow wire test	960°C
Maximum device temperature	55°C (Ta 25°C)
Appliance class	class III
Walkover	yes
Drive-over	up to 2000 kg
Power cables	includes 20 m neoprene cable H05RN-F 2x0.75/0.75 Ø6.3 mm
Protection systems	IPS (Intelligent Protection System); PID (Protective Impedance Device)
Photobiological safety	in accordance with IEC TR 62778:2014
Notes	version with 5° optics (with white LED colour and 3,5W power) available on request; version with 9W power (with white LED colour) available on request; Casambi control using the Casambi app with dedicated electronics

PHOTOMETRIC DATA

S - 17° CRI 80



ACCESSORIES

Installation Accessories



WC0100
Outer casing



WC0103
Outer casing



WC0150
Outer casing



WG0100
Retaining spring clip for installation on plasterboard Ø70mm

Anti-glare



WH0201
Honeycomb louvre
built into the lighting fixture
The honeycomb louvre can be fitted on all fixed optics except for the sharp, asymmetrical 8°, 8° and diffuse optics
Order together with the lighting fixture

Optical Accessories



WE0400A

Semi-diffusing screen, half transparent and half frosted
built into the lighting fixture

Can be fitted on all optics except for diffuse and asymmetrical 8° optics
and for RGB version

Order together with the lighting fixture

WE0400S

Anti-glare screen, half transparent and half serigraphed black
built into the lighting fixture

Can be fitted on all optics except for diffuse and asymmetrical 8° optics
and for RGB version

Order together with the lighting fixture

L&L Luce&Light SRL reserves the right to change the information contained in this document at any time without prior notice being given.