

Made in Italy

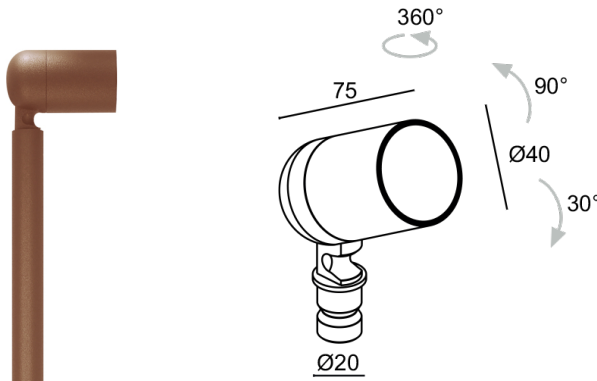

Pivot 1.9, code: CP19000000F0JT-2  
Bollards for outdoor applications

17/06/2026 Rev. 02/2024



## DESCRIPTION

bollard for outdoor applications; surface mounted (spike); Power consumption: 7W; Power supply: 24Vdc; Lumen output at source: 657 lm (3000K, 7W, CRI 80); Delivered lumen output: 463 lm (3000K, 34°, 7W, CRI 80); 1 high-intensity power LED, 3-step MacAdam, 50 000h L90 B10 (Ta 25°C); LED colour: 2700K; Optics: 45°; CRI Colour Rendering Index: 80; Body material: body made of ANTICORODAL EN AW 6082 low-copper-content aluminium alloy for excellent resistance to corrosion, made entirely on a CNC lathe; Finishes: cor-ten finish obtained through an initial treatment with a ceramic nanoparticle coating, to prepare for painting, followed by a coat of epoxy paint and one of polyester paint to provide corrosion resistance of more than 1000 hours of salt spray.; RAL finish on request; Screen material: 4-mm-thick transparent extra-clear glass with vitrified serigraphy, high transmittance to ensure chromatic uniformity of light and tempered for excellent resistance to knocks and scratches; Seals: the silicone rubber gaskets guarantee maximum resistance to UV rays and unchanging mechanical characteristics over time; Installation: Two installation options: spike with single lighting fixture, or spike with additional arm for a second lighting fixture. The pivot at the base of the lighting fixture enables great flexibility in aiming the light output.; power supply unit not included; includes 10 m neoprene cable, H05RN-F 2x0,35/0,75 Ø6,3 mm; Ingress protection: IP66; Impact resistance: IK07; Casambi control using the Casambi app with dedicated electronics; Protection systems: IPS (Intelligent Protection System) protects lighting fixtures from water infiltrations, which can occur if there are faulty junctions between the cables in outdoor or underwater applications. This innovation, patented by L&L, also guarantees electrical protection against polarity reversal, hot plugging, ESD and power surges, which can occur if there are faults in the electrical circuit; Operating temperature: -20°C — +45°C; Glow wire test: 960°C; Photobiological safety: photobiological safety: risk group 1 according to EN 62471:2006; Appliance class: class III; Weight: 240 g; Dimensions: Ø40x70 mm; Energy efficiency class: F (light source) in accordance with EU 2019/2015; Accessories: WB0310T Standard snoot - cor-ten, WB0311T Asymmetrical snoot - cor-ten, WPA00T Spike for in-ground installation - h 500 mm - cor-ten, WPA01T Spike for in-ground installation - h 800 mm - cor-ten, WPA02T Spike for in-ground installation - h 1100 mm - cor-ten, WPA03T Dual-fixture spike for in-ground installation - h 500 mm - cor-ten, WPA04T Dual-fixture spike for in-ground installation - h 800 mm - cor-ten, WPA11T Dual-fixture spike for in-ground installation - h 1100 mm - cor-ten; tested and approved via E.O.L. (End Of Line) test with functioning test and check of electrical power consumption

Status: Available

### ELECTRICAL CHARACTERISTICS

Power consumption	7W
Power supply	24Vdc
Power supply unit	power supply unit not included

### LIGHTING CHARACTERISTICS

Number and type of LED	1 high-intensity power LED
Average LED life	50 000h L90 B10 (Ta 25°C)
LED colour	2700K
CRI Colour Rendering Index	80
Binning	3-step MacAdam
Optics	45°
Lumen output at source	657 lm (3000K, 7W, CRI 80)
Delivered lumen output	463 lm (3000K, 34°, 7W, CRI 80)

### MECHANICAL CHARACTERISTICS

Dimensions	Ø40x70 mm
Weight	240 g
Finishes	cor-ten
Body material	body in anticorodal aluminium
Screen material	screen in serigraphed, transparent, tempered extra-clear glass

### GENERAL CHARACTERISTICS

Ingress protection	IP66
Operating temperature	-20°C — +45°C
Impact resistance	IK07
Energy efficiency class	F (light source) in accordance with EU 2019/2015
Glow wire test	960°C
Appliance class	class III
Walkover	no
Drive-over	no
Power cables	includes 10 m neoprene cable, H05RN-F 2x0,35/0,75 Ø6,3 mm
Protection systems	IPS (Intelligent Protection System)
Photobiological safety	photobiological safety: risk group 1 according to EN 62471:2006
Notes	Casambi control using the Casambi app with dedicated electronics

## PHOTOMETRIC DATA

J - 45° CRI 80



## ACCESSORIES

### Installation Accessories

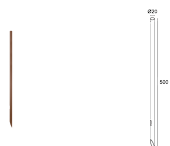

#### WPA00T

Spike for in-ground installation - h 500 mm - cor-ten  
Order together with the lighting fixture  
Required installation accessories, not included

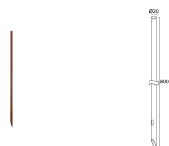

#### WPA01T

Spike for in-ground installation - h 800 mm - cor-ten  
Order together with the lighting fixture  
Required installation accessories, not included

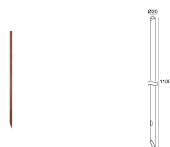

#### WPA02T

Spike for in-ground installation - h 1100 mm - cor-ten  
Order together with the lighting fixture  
Required installation accessories, not included

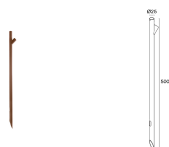

#### WPA03T

Dual-fixture spike for in-ground installation - h 500 mm - cor-ten  
Order together with two lighting fixtures  
Required installation accessories, not included

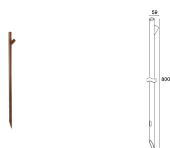

#### WPA04T

Dual-fixture spike for in-ground installation - h 800 mm - cor-ten  
Order together with two lighting fixtures  
Required installation accessories, not included

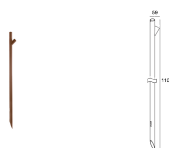

#### WPA11T

Dual-fixture spike for in-ground installation - h 1100 mm - cor-ten  
Order together with two lighting fixtures  
Required installation accessories, not included

### Anti-glare



WB0310T

Standard snoot - cor-ten

WB0311T

Asymmetrical snoot - cor-ten

L&L Luce&Light SRL reserves the right to change the information contained in this document at any time without prior notice being given.