

Made in Italy

 **Pivot 2.9, code: CP290110005R3T**
Bollards for outdoor applications

25/05/2026 Rev. 02/2024

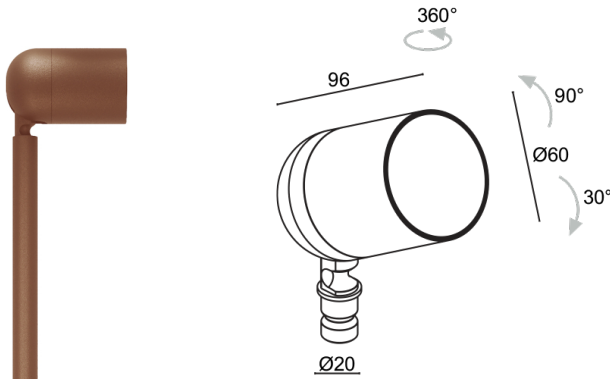

DESCRIPTION

bollard for outdoor applications; surface mounted (spike); Power consumption: 14W; Power supply: 24Vdc; Lumen output at source: 1173 lm (3000K, 14W, CRI >90); Delivered lumen output: 862 lm (3000K, 25°, 14W, CRI >90); 1 COB LED, 3-step MacAdam, 50 000h L95 B10 (Ta 25°C); LED colour: 3000K; Optics: optical range 15°–43°; CRI Colour Rendering Index: >90; Body material: body made of ANTICORODAL EN AW 6082 low-copper-content aluminium alloy for excellent resistance to corrosion, made entirely on a CNC lathe; Finishes: cor-ten finish obtained through an initial treatment with a ceramic nanoparticle coating, to prepare for painting, followed by a coat of epoxy paint and one of polyester paint to provide corrosion resistance of more than 1000 hours of salt spray.; RAL finish on request; Screen material: 3-mm-thick transparent extra-clear glass with vitrified serigraphy, high transmittance to ensure chromatic uniformity of light and tempered for excellent resistance to knocks and scratches; Seals: The NBR nitrile rubber O-rings ensure the fixture's IP rating is preserved, guaranteeing continued protection; Installation: Two installation options: spike with single lighting fixture, or spike with additional arm for a second lighting fixture. The pivot at the base of the lighting fixture enables great flexibility in aiming the light output.; power supply unit not included; includes 1.50 m neoprene cable, H05RN-F 2x0,35/0,75 Ø6,3 mm; Ingress protection: IP66; Impact resistance: IK08; Casambi control using the Casambi app with dedicated electronics; Protection systems: IPS (Intelligent Protection System) protects lighting fixtures from water infiltrations, which can occur if there are faulty junctions between the cables in outdoor or underwater applications. This innovation, patented by L&L, also guarantees electrical protection against polarity reversal, hot plugging, ESD and power surges, which can occur if there are faults in the electrical circuit; Operating temperature: -20°C — +45°C; Glow wire test: 960°C; Photobiological safety: photobiological safety: risk group 1 according to EN 62471:2006; Appliance class: class III; Weight: 560 g; Dimensions: Ø60x96 mm; Energy efficiency class: F (light source) in accordance with EU 2019/2015; Accessories: WB1001T Standard snoot - cor-ten, WB1002T Asymmetrical snoot - cor-ten, WB1003N Barn doors - black, WPA00T Spike for in-ground installation - h 500 mm - cor-ten, WPA01T Spike for in-ground installation - h 800 mm - cor-ten, WPA02T Spike for in-ground installation - h 1100 mm - cor-ten, WPA03T Dual-fixture spike for in-ground installation - h 500 mm - cor-ten, WPA04T Dual-fixture spike for in-ground installation - h 800 mm - cor-ten, WPA11T Dual-fixture spike for in-ground installation - h 1100 mm - cor-ten; tested and approved via E.O.L. (End Of Line) test with functioning test and check of electrical power consumption

Status: Available

ELECTRICAL CHARACTERISTICS

Power consumption	14W
Power supply	24Vdc
Power supply unit	power supply unit not included

LIGHTING CHARACTERISTICS

Number and type of LED	1 COB LED
Average LED life	50 000h L95 B10 (Ta 25°C)
LED colour	3000K
CRI Colour Rendering Index	>90
Binning	3-step MacAdam
Optics	optical range 15° – 43°
Lumen output at source	1173 lm (3000K, 14W, CRI >90)
Delivered lumen output	862 lm (3000K, 25°, 14W, CRI >90)

MECHANICAL CHARACTERISTICS

Dimensions	Ø60x96 mm
Weight	560 g
Finishes	cor-ten
Body material	body in anticorodal aluminium
Screen material	screen in serigraphed, transparent, tempered extra-clear glass

GENERAL CHARACTERISTICS

Ingress protection	IP66
Operating temperature	-20°C – +45°C
Impact resistance	IK08
Energy efficiency class	F (light source) in accordance with EU 2019/2015
Glow wire test	960°C
Appliance class	class III
Walkover	no
Drive-over	no
Power cables	includes 1.50 m neoprene cable, H05RN-F 2x0,35/0,75 Ø6,3 mm
Protection systems	IPS (Intelligent Protection System)
Photobiological safety	photobiological safety: risk group 1 according to EN 62471:2006
Notes	Casambi control using the Casambi app with dedicated electronics

PHOTOMETRIC DATA

R3 - zoom 15° (15°-43°) CRI80

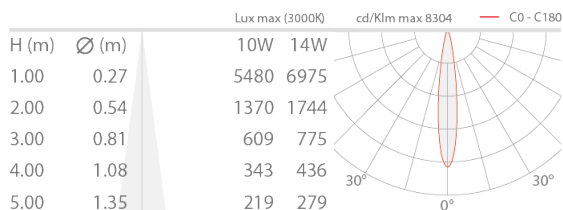

R3 - zoom 43° (15°-43°) CRI80

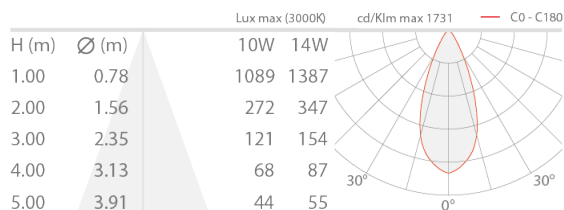

ACCESSORIES

Installation Accessories

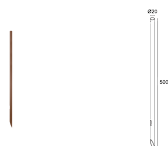

WPA00T

Spike for in-ground installation - h 500 mm - cor-ten
Order together with the lighting fixture
Required installation accessories, not included

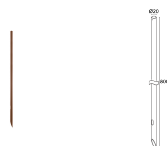

WPA01T

Spike for in-ground installation - h 800 mm - cor-ten
Order together with the lighting fixture
Required installation accessories, not included

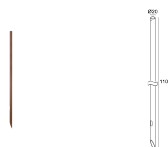

WPA02T

Spike for in-ground installation - h 1100 mm - cor-ten
Order together with the lighting fixture
Required installation accessories, not included

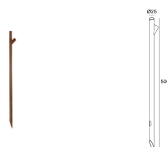

WPA03T

Dual-fixture spike for in-ground installation - h 500 mm - cor-ten
Order together with two lighting fixtures
Required installation accessories, not included

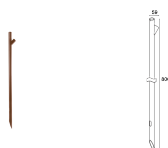

WPA04T

Dual-fixture spike for in-ground installation - h 800 mm - cor-ten
Order together with two lighting fixtures
Required installation accessories, not included

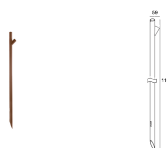

WPA11T

Dual-fixture spike for in-ground installation - h 1100 mm - cor-ten
Order together with two lighting fixtures
Required installation accessories, not included

Anti-glare



WB1001T

Standard snoot - cor-ten

**WB1002T**

Asymmetrical snoot - cor-ten

WB1003N

Barn doors - black

L&L Luce&Light SRL reserves the right to change the information contained in this document at any time without prior notice being given.