















Made in Italy

 **Altopiano 2.1, code: AP21100D0250LH**  
Recessed for outdoor applications

06/07/2026 Rev. 03/2024



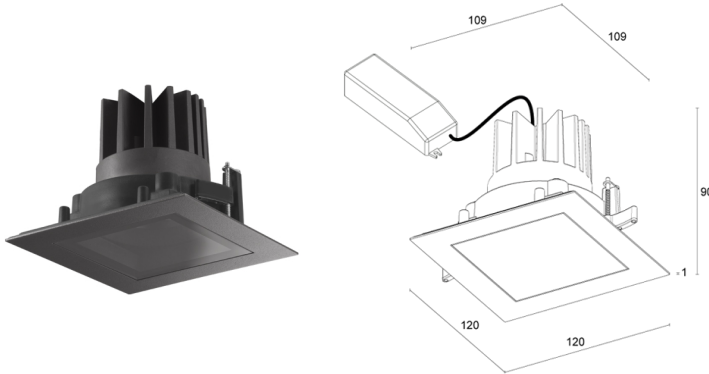



 0,7 kg
  110x110 mm
  IP66
  IK07
  DALI-2
 





## DESCRIPTION

recessed for outdoor applications; recessed (ceiling); Power consumption: 16W; Power supply: 110-230Vac; Lumen output at source: 1616 lm (3000K, CRI 80); Delivered lumen output: 1251 lm (3000K, 57°, CRI 80); 1 COB LED, 2-step MacAdam, 60 000h L90 B10 (Ta 25°C); LED colour: 3000K; Optics: 38°: optical system consisting of a high-efficiency, deep-set TIR lens combined with a high-quality technical filter; CRI Colour Rendering Index: 80; Body material: body made of heat-dissipating, carbon-fibre-reinforced semicrystalline technopolymer with a thermal conductivity equal to that of stainless steel and high resistance to impact and sub-zero temperatures, and to corrosion even in harsh environments (saline). Trim in AISI 430 stainless steel, laser cut, machined and finished, then passivated to provide corrosion resistance of more than 1500 salt spray hours; Finishes: anthracite finish obtained through an initial treatment with a ceramic nanoparticle coating, to prepare for painting, followed by a coat of epoxy paint and one of polyester paint to provide corrosion resistance of more than 1500 hours of salt spray. Paints compliant with the Qualicoat standard used in the automotive sector; RAL finish on request; Screen material: 4-mm-thick transparent extra-clear glass, high transmittance to ensure chromatic uniformity of light, serigraphed grey (RAL 7015), and tempered for excellent impact and scratch resistance; Seals: the silicone rubber gaskets guarantee maximum resistance to UV rays and unchanging mechanical characteristics over time; Installation: The screw fastening system leaves plasterboard panels intact during installation. Fixture body just 90 mm high for installation in shallow spaces. Trim fixed magnetically to the cover, hiding the fixing screws and leaving a clean look; power supply unit included; includes 0.50 m neoprene cable, H07RN-F 2x1.0 Ø8.0 mm; Control system: DALI-2; Ingress protection: IP66; Impact resistance: IK07; UGR < 19 for 16°, 26° and 38° optics; Operating temperature: -20°C — +45°C; Maximum device temperature: 45°C (Ta 25°C); Glow wire test: 960°C; Photobiological safety: in accordance with IEC TR 62778:2014; Appliance class: class II; Weight: 700 g; Dimensions: 120x120x90 mm; Cutout dimensions: 110x110 mm; Volume of thermal heatsink: Ø275x175 mm; Energy efficiency class: F (light source) in accordance with EU 2019/2015; Accessories: anti-glare shield, WCA21 Outer casing for solid walls (ceiling), WFA06 Two-pin male-female connector, WGA02 Retaining spring clip for installation on plasterboard, WNAP10A0 Anti-fall kit; tested and approved via E.O.L. (End Of Line) test with functioning test and check of electrical power consumption

Status: Available

### ELECTRICAL CHARACTERISTICS

Power consumption	16W
Power supply	110-230Vac
Power supply unit	power supply unit included
Control system	DALI-2

### LIGHTING CHARACTERISTICS

Number and type of LED	1 COB LED
Average LED life	60 000h L90 B10 (Ta 25°C)
LED colour	3000K
CRI Colour Rendering Index	80
Binning	2-step MacAdam
Optics	38°
Lumen output at source	1616 lm (3000K, CRI 80)
Delivered lumen output	1251 lm (3000K, 57°, CRI 80)

### MECHANICAL CHARACTERISTICS

Dimensions	120x120x90 mm
Weight	700 g
Finishes	anthracite
Mounting	screw fastening system
Body material	body in thermally conductive technopolymer, trim in stainless steel
Screen material	screen in serigraphed-grey and transparent, tempered extra-clear glass
Cutout dimensions	110x110 mm
Volume of thermal heatsink	Ø275x175 mm

### GENERAL CHARACTERISTICS

Ingress protection	IP66
Operating temperature	-20°C — +45°C
Impact resistance	IK07
Features	UGR < 19 for 16°, 26° and 38° optics
Energy efficiency class	F (light source) in accordance with EU 2019/2015
Glow wire test	960°C
Maximum device temperature	45°C (Ta 25°C)
Appliance class	class II
Walkover	no
Drive-over	no
Power cables	includes 0.50 m neoprene cable, H07RN-F 2x1.0 Ø8.0 mm
Photobiological safety	in accordance with IEC TR 62778:2014

## PHOTOMETRIC DATA

L – 38° CRI80

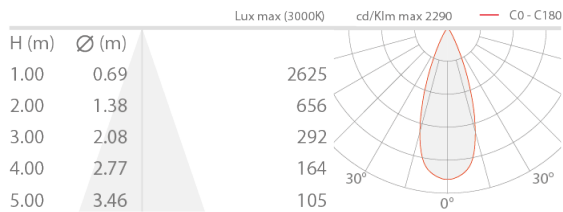

## ACCESSORIES

## Installation Accessories

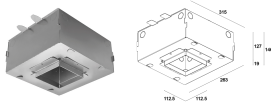

## WCA21

Outer casing for solid walls (ceiling)

## WGA02

Retaining spring clip for installation on plasterboard

## Anti-glare

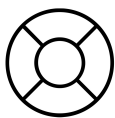

## anti-glare shield

built into the lighting fixture

The anti-glare shield can be provided on all fixed optics except for diffuse and elliptical optics

Add the optical accessory in the code generator

## Other



## WFA06

Two-pin male-female connector

IP66-IP68

Ø23x95 mm



## WNAP10A0

Anti-fall kit

L&L Luce&Light SRL reserves the right to change the information contained in this document at any time without prior notice being given.