













Made in Italy

 **Duomo 4.0, code: DU40100D0150JH**
Projectors for outdoor applications



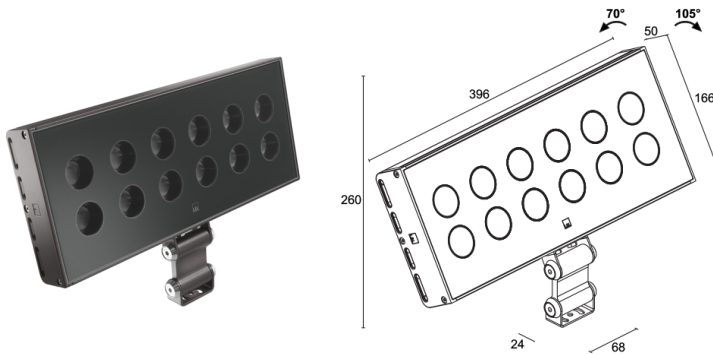

 kg 3,50
 





 70°
 105°



DESCRIPTION

projector for outdoor applications; surface mounted (ceiling, wall, floor); Power consumption: 56W; Power supply: 230Vac; Lumen output at source: 5280 lm (3000K, CRI 80); Delivered lumen output: 4284 lm (3000K, 30°, CRI 80); 12 power LEDs High Intensity, 3-step MacAdam, 50 000h L90 B10 (Ta 25°C); LED colour: 3000K; Optics: 43°: optical system consisting of 12 high-efficiency deep-set TIR lenses; CRI Colour Rendering Index: 80; Body material: body and bracket made of low-copper-content Anticorodal® aluminium alloy EN AW 6060 T5 for excellent resistance to corrosion. Body and bracket made by an extrusion process and subsequently finished on a CNC lathe; Finishes: anthracite finish obtained through an initial treatment with a ceramic nanoparticle coating, to prepare for painting, followed by a coat of epoxy paint and one of polyester paint to provide corrosion resistance of more than 1000 hours of salt spray; RAL finish on request; Screen material: 4-mm-thick transparent extra-clear glass with vitrified serigraphy, high transmittance to ensure chromatic uniformity of light and tempered for excellent resistance to knocks and scratches. Serigraphy in the same shade as the body of the fixture; Seals: the silicone rubber gaskets guarantee maximum resistance to UV rays and unchanging mechanical characteristics over time; Installation: product complete with IP68 connector and built-in PID system. Compatible with cables with minimum cross-section 2x1 and cable Ø min. 7 mm max. 12 mm. Simplified connection for quick, effective installation. Duomo's adjustable bracket means the fixture can be cantilevered from cornices or other architectural elements. Body can be tilted along the vertical axis by ± 20°; built-in power supply unit; Control system: PUSH, DALI-2; Ingress protection: IP65; Impact resistance: IK06; Fast installation: direct connection between fixture and mains power supply; available on request with adapter for Eurostandard track and in 0/1-10V version, or with Bluetooth control; Protection systems: The PID (Protective Impedance Device) protects lighting fixtures from electrical phenomena external to the system, such as static electricity accumulation or electromagnetic interference coming from the mains power. Generally, these are events with a low energy content; Operating temperature: -20°C — +45°C; Glow wire test: 960°C; Photobiological safety: photobiological safety: risk group 1 according to EN 62471:2006; Appliance class: class II; Weight: 3500 g; Dimensions: 396x166x50 mm; Energy efficiency class: F (light source) in accordance with EU 2019/2015; Accessories: honeycomb louvre, WFA01 4-pin male connector, WMA00H Adjustable bracket, WMA06H Fixing bracket; tested and approved via E.O.L. (End Of Line) test with functioning test and check of electrical power consumption

Status: Available

ELECTRICAL CHARACTERISTICS

Power consumption	56W
Power supply	230Vac
Power supply unit	built-in power supply unit
Control system	PUSH, DALI-2

LIGHTING CHARACTERISTICS

Number and type of LED	12 power LEDs High Intensity
Average LED life	50 000h L90 B10 (Ta 25°C)
LED colour	3000K
CRI Colour Rendering Index	80
Binning	3-step MacAdam
Optics	43°
Lumen output at source	5280 lm (3000K, CRI 80)
Delivered lumen output	4284 lm (3000K, 30°, CRI 80)

MECHANICAL CHARACTERISTICS

Dimensions	396x166x50 mm
Weight	3500 g
Finishes	anthracite
Mounting	with screws and plugs
Body material	body and arm in Anticorodal aluminium
Screen material	screen in serigraphed, tempered, extra-clear glass

GENERAL CHARACTERISTICS

Ingress protection	IP65
Operating temperature	-20°C — +45°C
Impact resistance	IK06
Features	Fast installation: direct connection between fixture and mains power supply
Energy efficiency class	F (light source) in accordance with EU 2019/2015
Glow wire test	960°C
Appliance class	class II
Walkover	no
Drive-over	no
Protection systems	PID (Protective Impedance Device)
Photobiological safety	photobiological safety: risk group 1 according to EN 62471:2006
Notes	available on request with adapter for Eurostandard track and in 0/1-10V version, or with Bluetooth control

PHOTOMETRIC DATA

J - 43° CRI 80

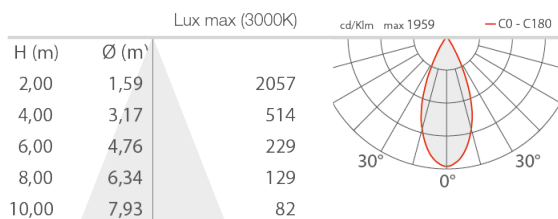

ACCESSORIES

Anti-glare

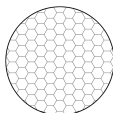

honeycomb louvre

built into the lighting fixture

Not compatible with 10° optics

Add the optical accessory in the code generator

Other



WFA01

4-pin male connector

for in/out connection

IP68

Ø23x50 mm



WMA00H

Adjustable bracket

anthracite



WMA06H

Fixing bracket

anthracite

L&L Luce&Light SRL reserves the right to change the information contained in this document at any time without prior notice being given.