

Made in Italy

 **Krill 2.0, code: KI2020100050XN**
Projectors for indoor applications

10/05/2026 Rev. 10/2024

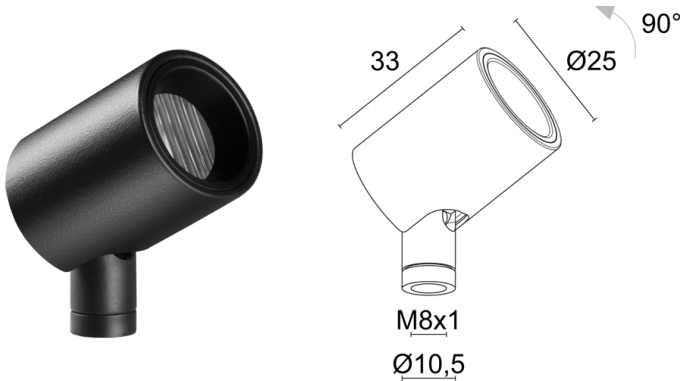
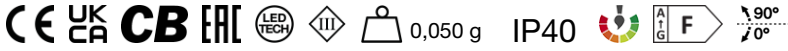

DESCRIPTION

projector for indoor applications; surface mounted (shop windows, display cabinets, shelves, ceiling, wall); Power consumption: max 2,5W; Power supply: max 700mA; Lumen output at source: 202 lm (3000K, 700mA); Delivered lumen output: 150 lm (3000K, 700mA, 17°); 1 power LED, 1/4 ANSI BIN, 50 000h L90 B10 (Ta 25°C); LED colour: 3000K; Optics: 50°x23°: optical system consisting of a high-efficiency elliptical TIR lens; CRI Colour Rendering Index: >90; Body material: body made of ANTICORODAL EN AW 6026 low-copper-content aluminium alloy for excellent resistance to corrosion, made entirely on a CNC lathe. Joint made of brass and produced entirely on a CNC lathe.; Finishes: cylindrical cover and joint painted black, body electro-coloured black (RAL 9005); RAL finish on request; Installation: versatile installation thanks to its accessories: arm with fixing base, nipple coupler, magnetic plate, fixing springs and ceiling rose; power supply unit not included; Wiring: series; includes 1.50 m PVC cable HT105° 2x0,20 Ø3,0 mm; Control system: dimming via dimmable driver; Ingress protection: IP40; The cylindrical cover can be removed and replaced with the standard snoot. To attach the honeycomb louvre, remove the cylindrical cover, screw on the anti-glare accessory and replace the cover; Casambi control using the Casambi app with dedicated electronics; Operating temperature: 0°C — +45°C; Photobiological safety: photobiological safety: risk group 1 according to EN 62471:2006; Appliance class: class III; Weight: 50 g; Dimensions: ø25x33 mm; Energy efficiency class: F (light source) in accordance with EU 2019/2015; Accessories: WBA00N Standard snoot - black, WDA00N Fixing base, WDA01N Rigid arm - h 150 mm, WDA02N Rigid arm - h 300 mm, WDA03N Ceiling rose, WDA04N Magnetic plate, WF0600 PVC cable HT105° 2x0,20 Ø3,0 mm, grey, WGA01 Nipple coupler, WGA08N Retaining spring clip Ø30mm, WHKI20A0 Honeycomb louvre; tested and approved via E.O.L. (End Of Line) test with functioning test and check of electrical power consumption

Status: Available

ELECTRICAL CHARACTERISTICS

Power consumption	max 2,5W
Power supply	max 700mA
Power supply unit	power supply unit not included
Control system	dimming via dimmable driver
Wiring	series

LIGHTING CHARACTERISTICS

Number and type of LED	1 power LED
Average LED life	50 000h L90 B10 (Ta 25°C)
LED colour	3000K
CRI Colour Rendering Index	>90
Binning	1/4 ANSI BIN
Optics	50°x23°
Lumen output at source	202 lm (3000K, 700mA)
Delivered lumen output	150 lm (3000K, 700mA, 17°)

MECHANICAL CHARACTERISTICS

Dimensions	ø25x33 mm
Weight	50 g
Finishes	black RAL 9005
Body material	body in anticorodal aluminium, joint in brass

GENERAL CHARACTERISTICS

Ingress protection	IP40
Operating temperature	0°C — +45°C
Energy efficiency class	F (light source) in accordance with EU 2019/2015
Appliance class	class III
Walkover	no
Drive-over	no
Power cables	includes 1.50 m PVC cable HT105° 2x0,20 Ø3,0 mm
Photobiological safety	photobiological safety: risk group 1 according to EN 62471:2006

Notes The cylindrical cover can be removed and replaced with the standard snoot. To attach the honeycomb louvre, remove the cylindrical cover, screw on the anti-glare accessory and replace the cover; Casambi control using the Casambi app with dedicated electronics

PHOTOMETRIC DATA

X – 50°x23°

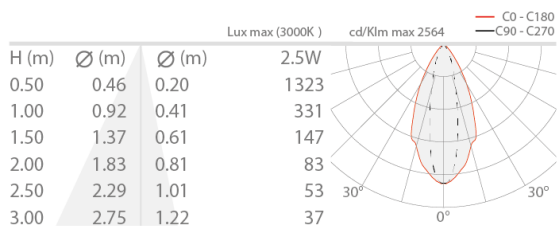

ACCESSORIES

Installation Accessories

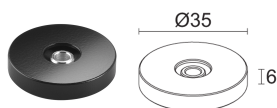

WDA00N

Fixing base
black

Required installation accessories, not included

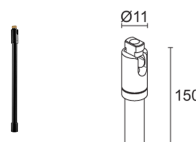

WDA01N

Rigid arm - h 150 mm
black

Order together with the fixing base or the nipple

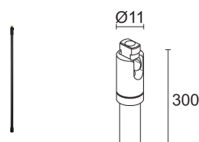

WDA02N

Rigid arm - h 300 mm
black

Order together with the fixing base or the nipple

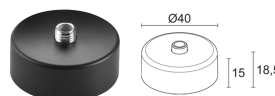

WDA03N

Ceiling rose
black

Required installation accessories, not included

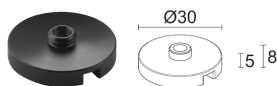

WDA04N

Magnetic plate
black

Required installation accessories, not included

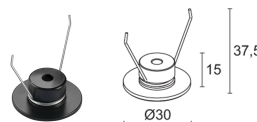

WGA08N

Retaining spring clip Ø30mm
black

Required installation accessories, not included

Anti-glare



WBA00N

Standard snoot - black

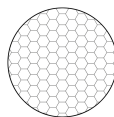

WHKI20A0

Honeycomb louvre

Other

WF0600

PVC cable HT105° 2x0,20 Ø3,0 mm, grey

your choice of length

To be ordered by meter for lengths other than the standard one (1.5 m)

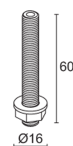

WGA01

Nipple coupler

Required installation accessories, not included

L&L Luce&Light SRL reserves the right to change the information contained in this document at any time without prior notice being given.