

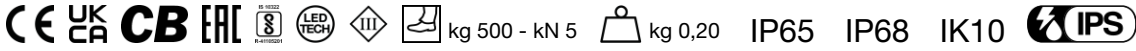









Made in Italy

 **Bright 1.B, code: CB1B0105R2TI**  
Step lights for outdoor applications

14/05/2026 Rev. 13/2024

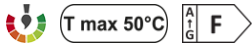



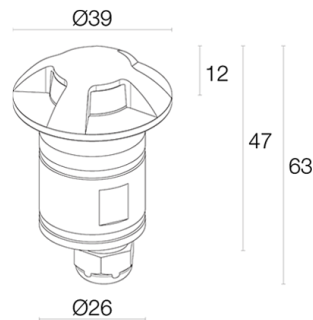

 kg 500 - kN 5
  kg 0,20
 IP65 IP68 IK10
 

 T max 50°C
 



## DESCRIPTION

step light for outdoor applications (not suitable for use in immersion in swimming pools or fountains); walkover up to 500 kg; recessed (wall, floor); Power consumption: 3,5W; Power supply: 24Vdc; Lumen output at source: 220 lm (3000K, 3.5W); Delivered lumen output: 56 lm (3000K, 4x60°, 3.5W); 1 power LED, 1/4 ANSI BIN, 50 000h L90 B10 (Ta 25°C); LED colour: 3000K; Optics: radial 2x60°: optical system, with silicone optics for durability, that in combination with the trim enables the creation of a light beam through two 60° windows; Upward flux fraction: 32,83% (1x60°, 2x60°, 3x60°, 4x60°), 28,34% (1x120°), 30,63% (1x180°); CRI Colour Rendering Index: 80; Body material: body made of AISI 316L stainless steel, made on a CNC lathe. Head in AISI 316L stainless steel worked with tumbling and micro-shot peening, and then electropolished; Finishes: stainless steel; RAL finish on request; Seals: the silicone rubber gaskets guarantee maximum resistance to UV rays and unchanging mechanical characteristics over time; Thickness of installation surface: min 5 mm, max 30 mm; power supply unit not included; includes 1.5 m neoprene cable, H05RN-F 2x0,35/0,75 Ø6,3 mm; Ingress protection: IP65, IP68; Impact resistance: IK10; Casambi control using the Casambi app with dedicated electronics; Protection systems: IPS (Intelligent Protection System) protects lighting fixtures from water infiltrations, which can occur if there are faulty junctions between the cables in outdoor or underwater applications. This innovation, patented by L&L, also guarantees electrical protection against polarity reversal, hot plugging, ESD and power surges, which can occur if there are faults in the electrical circuit; Operating temperature: -20°C — +45°C; Maximum device temperature: 50°C (Ta 25°C); Glow wire test: 960°C; Photobiological safety: in accordance with IEC TR 62778:2014; Appliance class: class III; Weight: 200 g; Dimensions: Ø39x63 mm; Cutout dimensions: Ø30 mm; Volume of thermal heatsink: Ø80x100 mm; Energy efficiency class: F (light source) in accordance with EU 2019/2015; Accessories: WC0202 Outer casing; tested and approved via E.O.L. (End Of Line) test with functioning test and check of electrical power consumption

Status: Available

### ELECTRICAL CHARACTERISTICS

Power consumption	3,5W
Power supply	24Vdc
Power supply unit	power supply unit not included

### LIGHTING CHARACTERISTICS

Number and type of LED	1 power LED
Average LED life	50 000h L90 B10 (Ta 25°C)
LED colour	3000K
CRI Colour Rendering Index	80
Binning	1/4 ANSI BIN
Optics	radial 2x60°
Lumen output at source	220 lm (3000K, 3.5W)
Delivered lumen output	56 lm (3000K, 4x60°, 3.5W)

### MECHANICAL CHARACTERISTICS

Dimensions	Ø39x63 mm
Weight	200 g
Finishes	stainless steel
Mounting	with outer casing
Body material	body and trim in AISI 316L stainless steel
Cutout dimensions	Ø30 mm
Volume of thermal heatsink	Ø80x100 mm

### GENERAL CHARACTERISTICS

Ingress protection	IP65, IP68
Operating temperature	-20°C – +45°C
Impact resistance	IK10
Energy efficiency class	F (light source) in accordance with EU 2019/2015
Glow wire test	960°C
Maximum device temperature	50°C (Ta 25°C)
Appliance class	class III
Drive-over	no
Walkover	up to 500 kg
Power cables	includes 1.5 m neoprene cable, H05RN-F 2x0,35/0,75 Ø6,3 mm
Protection systems	IPS (Intelligent Protection System)
Photobiological safety	in accordance with IEC TR 62778:2014
Notes	Casambi control using the Casambi app with dedicated electronics

## PHOTOMETRIC DATA

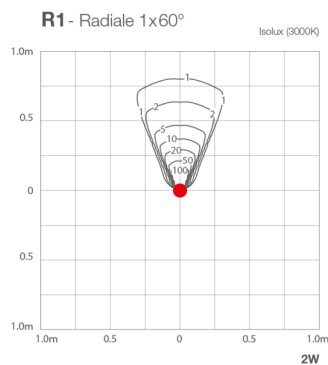

## ACCESSORIES

### Installation Accessories



WC0202  
Outer casing

L&L Luce&Light SRL reserves the right to change the information contained in this document at any time without prior notice being given.