































Made in Italy

 Spot 1.0, code: CF10129SAI
Projectors for outdoor applications

01/11/2024 Rev. 33





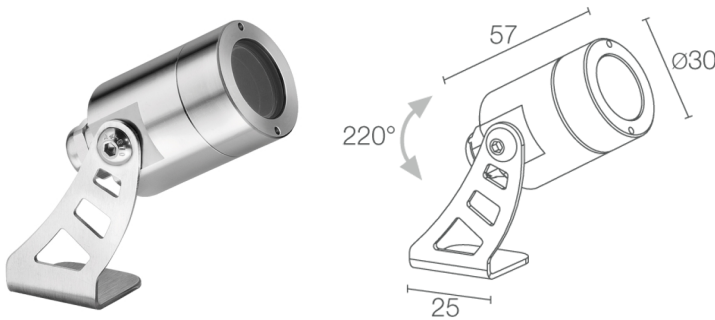

 on request
 

 kg 0,40
 



















 F



DESCRIPTION

projector for outdoor applications (not suitable for use in immersion in swimming pools or fountains); surface mounted (ceiling, wall, ground, spike, strap); Power consumption: max 2W; Power supply: max 500mA; Lumen output at source: 145 lm (3000K, 500mA); Delivered lumen output: 88 lm (3000K, 500mA, 20°); 1 power LED, 1/4 ANSI BIN, 50 000h L90 B10 (Ta 25°C); LED colour: 4000K; Optics: 10°; CRI Colour Rendering Index: 80; Body material: body and trim in AISI 316L stainless steel; RAL finish on request; Screen material: screen in tempered, transparent glass; power supply unit not included; Wiring: series; includes 1.5 m neoprene cable, H05RN-F 2x0,35/0,75 Ø6,3 mm; Control system: dimming via dimmable driver; Ingress protection: IP68; Impact resistance: IK10; version with elliptical optics available on request; Casambi control using the Casambi app with dedicated electronics; Protection systems: IPS (Intelligent Protection System) protects lighting fixtures from water infiltrations, which can occur if there are faulty junctions between the cables in outdoor or underwater applications. This innovation, patented by L&L, also guarantees electrical protection against polarity reversal, hot plugging, ESD and power surges, which can occur if there are faults in the electrical circuit; Operating temperature: -20°C — +45°C; Glow wire test: 960°; Photobiological safety: photobiological safety: risk group 1 according to EN 62471:2006; Appliance class: class III; Weight: 400 g; Dimensions: Ø30x57mm; Energy efficiency class: F (light source) in accordance with EU 2019/2015; Accessories: WB0320I Standard snoot - stainless steel, WB0321I Asymmetrical snoot - stainless steel, WH0101 Honeycomb louvre, WP0100 Spike for in-ground installation, WP1004 Fastener strap - 5 m; tested and approved via E.O.L. (End Of Line) test with functioning test and check of electrical power consumption

Status: Available

ELECTRICAL CHARACTERISTICS

Power consumption	max 2W
Power supply	max 500mA
Power supply unit	power supply unit not included
Control system	dimming via dimmable driver
Wiring	series

LIGHTING CHARACTERISTICS

Number and type of LED	1 power LED
Average LED life	50 000h L90 B10 (Ta 25°C)
LED colour	4000K
CRI Colour Rendering Index	80
Binning	1/4 ANSI BIN
Optics	10°
Lumen output at source	145 lm (3000K, 500mA)
Delivered lumen output	88 lm (3000K, 500mA, 20°)

MECHANICAL CHARACTERISTICS

Dimensions	Ø30x57mm
Weight	400 g
Mounting	with bracket and screws
Body material	body and trim in AISI 316L stainless steel
Screen material	screen in transparent, tempered glass

GENERAL CHARACTERISTICS

Ingress protection	IP68
Operating temperature	-20°C — +45°C
Impact resistance	IK10
Energy efficiency class	F (light source) in accordance with EU 2019/2015
Glow wire test	960°
Appliance class	class III
Walkover	no
Drive-over	no
Power cables	includes 1.5 m neoprene cable, H05RN-F 2x0,35/0,75 Ø6,3 mm
Protection systems	IPS (Intelligent Protection System)
Photobiological safety	photobiological safety: risk group 1 according to EN 62471:2006
Notes	version with elliptical optics available on request; Casambi control using the Casambi app with dedicated electronics

PHOTOMETRIC DATA

S - 10°

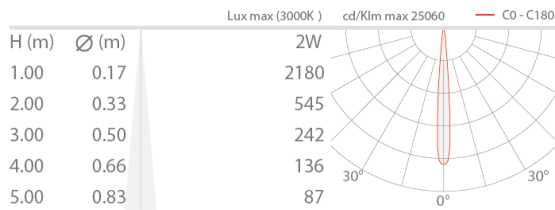

ACCESSORIES

Installation Accessories

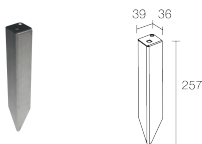

WP0100

Spike for in-ground installation

Anti-glare



WB0320I

Standard snoot - stainless steel



WB0321I

Asymmetrical snoot - stainless steel

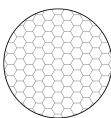

WH0101

Honeycomb louvre

built into the lighting fixture

The honeycomb louvre can be fitted on all fixed optics, except for sharp optics

Order together with the lighting fixture

Other



WP1004

Fastener strap - 5 m

L&L Luce&Light SRL reserves the right to change the information contained in this document at any time without prior notice being given.