

ACCESSORIO WG0505: MOLLA PER FISSAGGIO A CARTONGESSO PER SMOOTHY 5.0
Spring for recessed mounting

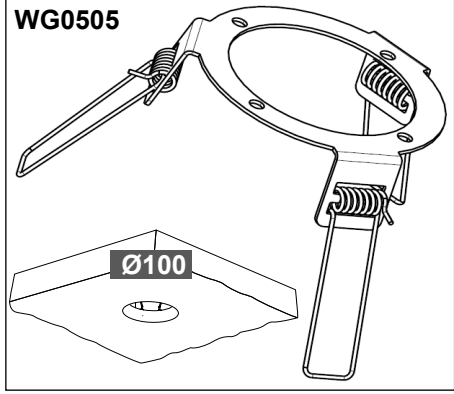

B (mm)	X (mm)	S (mm)	H min (mm)
Ø100	60min	0≥25	150

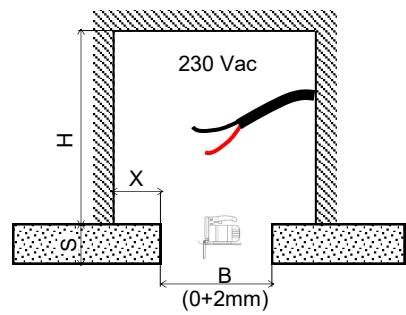

Overall volume
Volume per dissipazione
Ø220x150mm

