

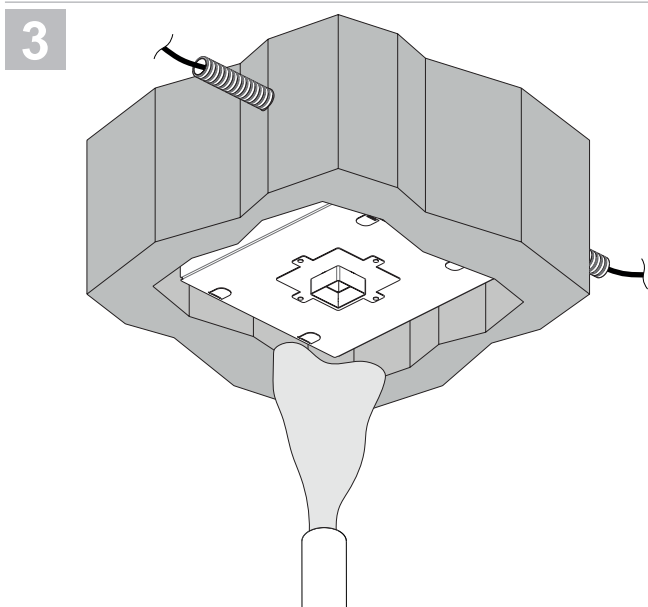

WC8700

Accessories / Accessori / Accessoires / Zubehör / Accesorios

Made in Italy

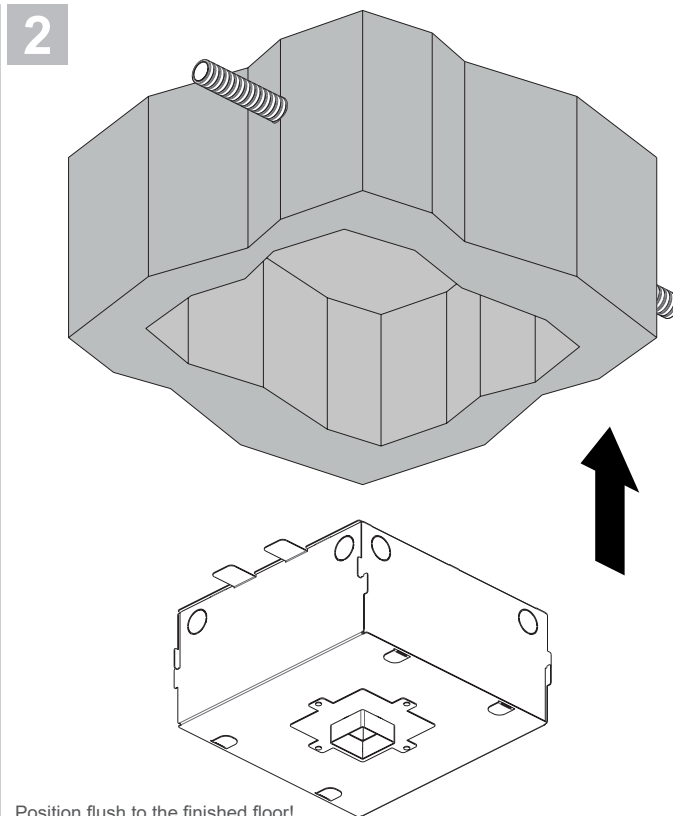
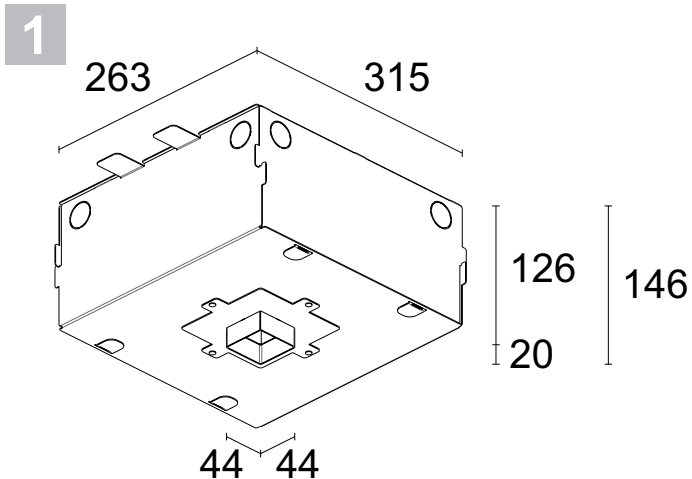

Position flush to the finished floor!
 Posizionare a filo pavimento finito!
 Positionner au ras du sol fini!
 Bodenbündig positionieren!
 Colocar a ras de suelo acabado!

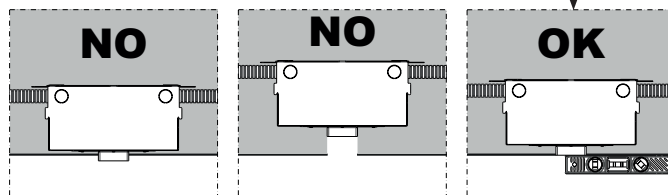

4

Concealed recessed spotlights: carefully apply plaster (by applying the microperforated paper) and smooth over the casing. Carefully clean the inside of the casing. All plaster residue must be removed.

Incasso a rasare: stuccare (applicando la carta microforata) e rasare accuratamente la cassaforma. Pulire accuratamente la parte interna della cassaforma! Non devono rimanere residui di stucco!!

Spot encastré à ras : mastiquer (en appliquant le papier microperforé) et mettre soigneusement le boîtier d'encastrement à ras. Nettoyer soigneusement la partie interne du boîtier d'encastrement ! Il ne doit pas y avoir de résidus de mastic !

Bündiger Einbau: Gehäuse sorgfältig verspachteln (Durch die Anwendung der mikroperforierte Papier) und bündig glattstreichen. Innenteile des Gehäuses sorgfältig reinigen, um überschüssige Spachtelmasse restlos zu entfernen!

Empotrado a ras: enmasillar (aplicando el papel microperforado) y enrasar atentamente la caja de empotrar. Limpiar cuidadosamente la parte interna de la caja de empotrar! No deben quedar residuos de masilla!!

